

La rétention de l'eau dans le sol est le principal contributeur de l'interception des flux polluants dans les ouvrages d'infiltration à la source

*Soil water retention is the primary mechanism for
contaminant trapping in source-control infiltration systems*

Garnier Robin¹, Tedoldi Damien¹, Castebrunet Hélène², Barraud Sylvie¹

¹Univ Lyon, INSA Lyon, DEEP, EA7429, F-69621, Villeurbanne Cedex, France

²Univ Grenoble Alpes, CNRS, IRD, Grenoble INP, IGE, 38000 Grenoble, France

- Urbanization and soil sealing disrupt the hydrological balance



- Urbanization and soil sealing disrupt the hydrological balance
- Human activities and land use lead to pollutants discharge

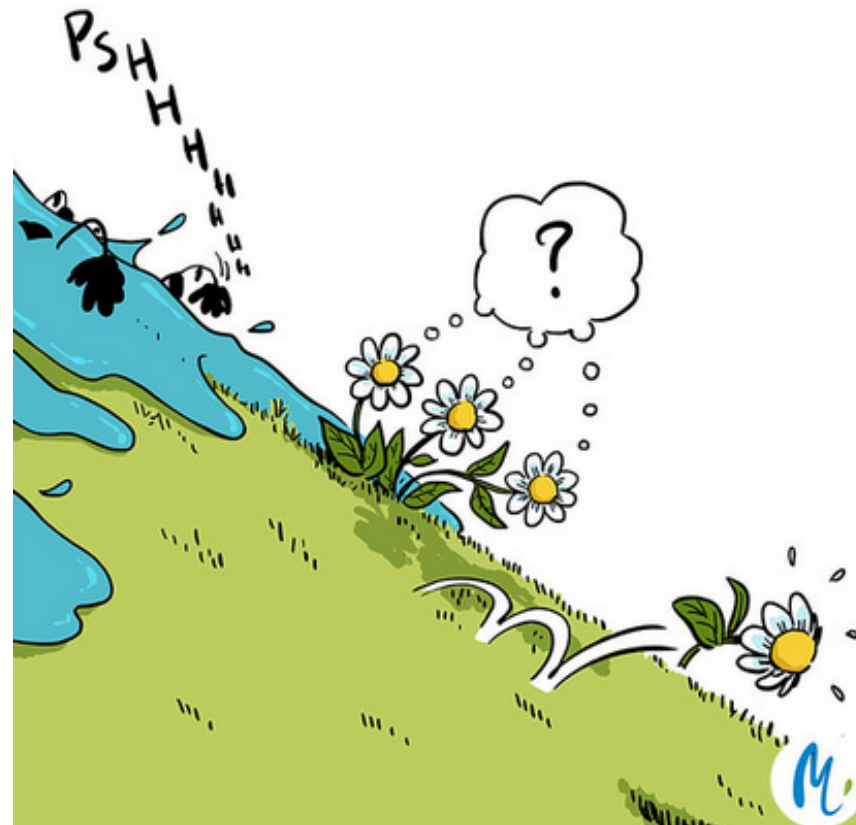

- Urbanization and soil sealing disrupt the hydrological balance
- Human activities and land use lead to pollutants discharge
- Increase of the use of SUDS to tend toward a more “natural” water cycle

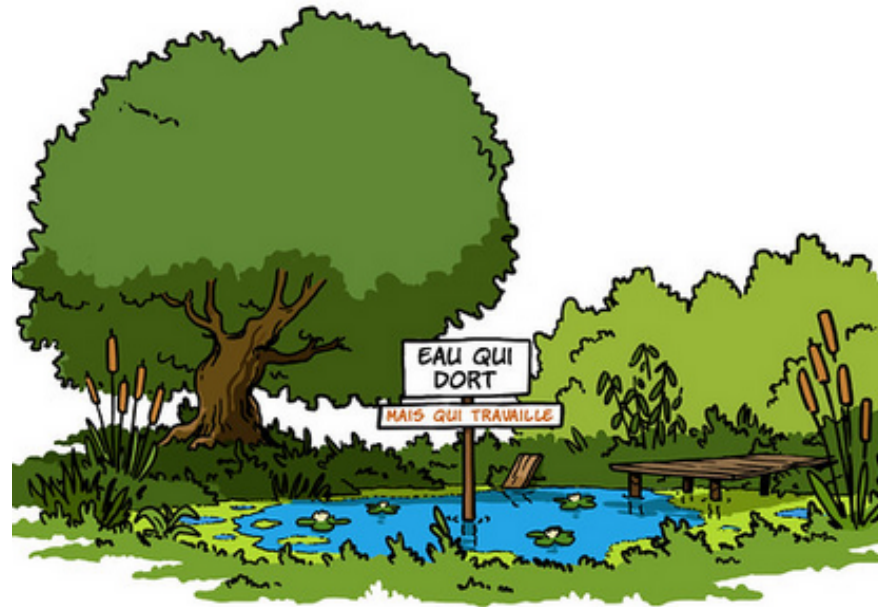

- Urbanization and soil sealing disrupt the hydrological balance
- Human activities and land use lead to pollutants discharge
- Increase of the use of SUDS to tend toward a more “natural” water cycle
- Numerous studies regarding pollutant **concentration removal** at lab-, pilot-, or field scale

- Urbanization and soil sealing disrupt the hydrological balance
- Human activities and land use lead to pollutants discharge
- Increase of the use of SUDS to tend toward a more “natural” water cycle
- Numerous studies regarding pollutant **concentration removal** at lab-, pilot-, or field scale

What about water retention as a contributor to pollution removal?

Sites



Porous Pavement with Reservoir Structure



Vegetated Infiltration Swale







Infiltration Trench

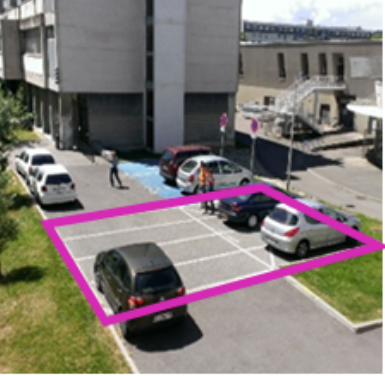
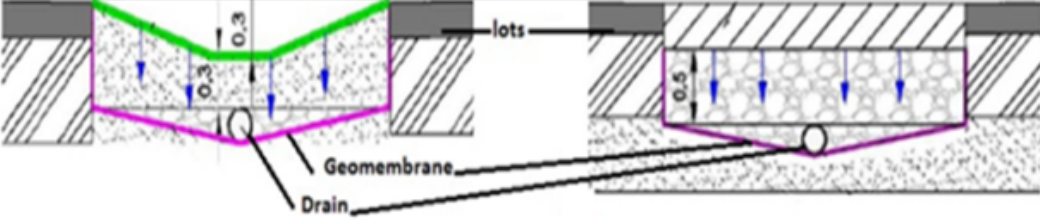
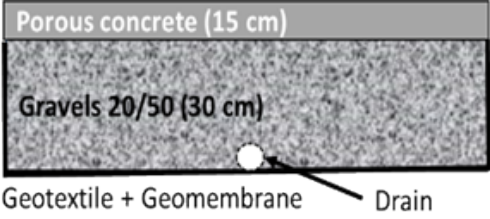

Metropolis of Lyon

Sites

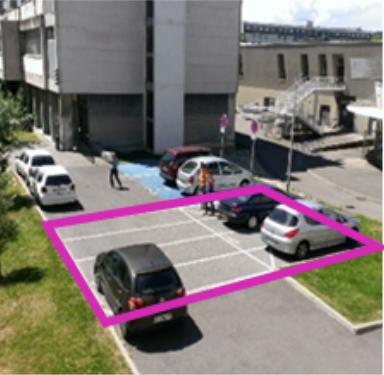
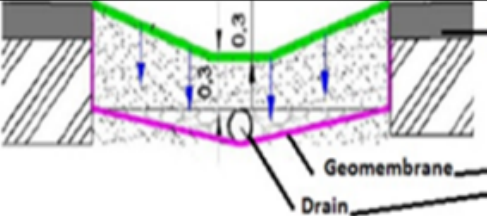
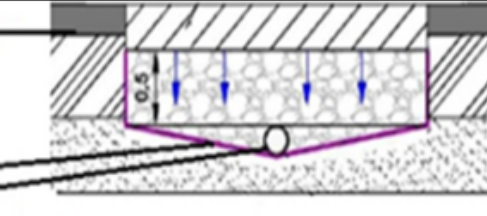
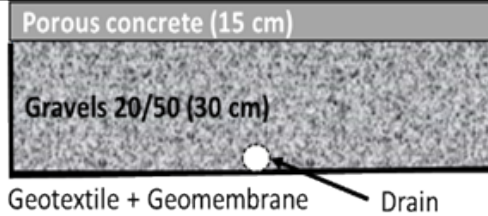

Vegetated Swale	Infiltration Trench	Porous Pavement and Reservoir Structure
		
<i>Catchment area – Infiltration area</i>		
$302\text{m}^2 - 30\text{m}^2$	$260\text{m}^2 - 26\text{m}^2$	$94\text{m}^2 - 94\text{M}^2$
<i>Cross section</i>		
		

Vegetated Swale	Infiltration Trench	Porous Pavement and Reservoir Structure
		
<i>Catchment area – Infiltration area</i>		
302m ² - 30m ²	260m ² - 26m ²	94m ² - 94M ²
<i>Cross section</i>		
		

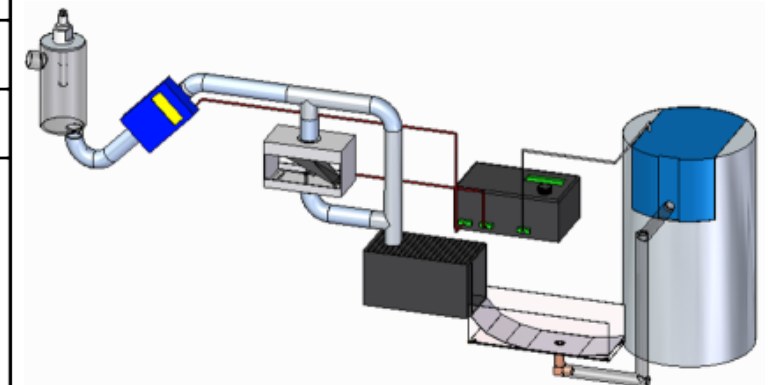
Monitoring and sampling devices for 54 micropollutants + TSS

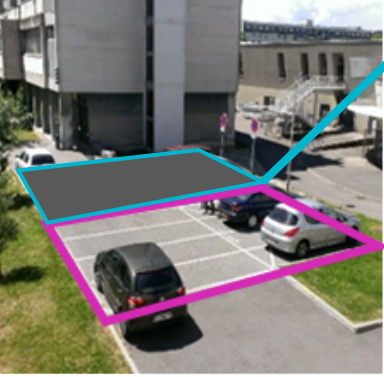
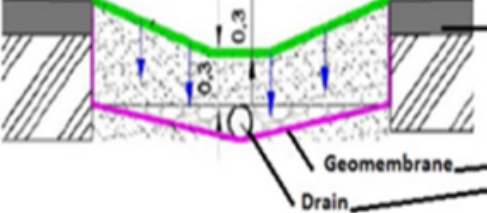
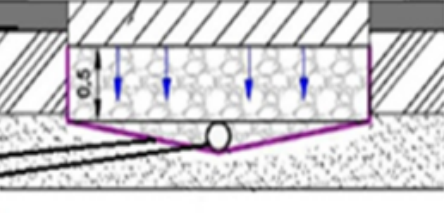
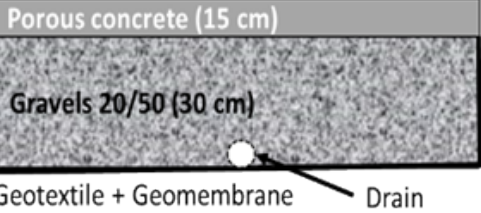

Sites

Vegetated Swale	Infiltration Trench	Porous Pavement and Reservoir Structure
		
<i>Catchment area – Infiltration area</i>		
302m ² - 30m ²	260m ² - 26m ²	94m ² - 94M ²
<i>Cross section</i>		
		

**Water quality reference :
Asphalted Impervious area (ASP)**

**Water quantity reference :
Rainfall measurements**

**Monitoring and sampling devices
for 54 micropollutants + TSS**

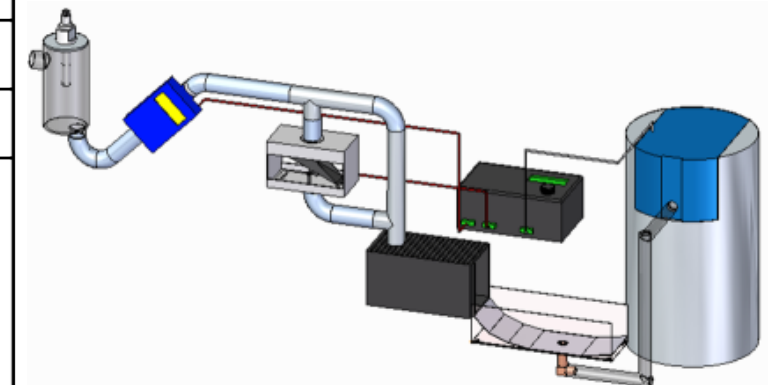

Event base performance

- Micropollutant fluxes reduction (mass reduction) :

$$\text{Removal}_M = \frac{M_{\text{in}} - M_{\text{out}}}{M_{\text{in}}}$$

Event base performance

- Micropollutant fluxes reduction (mass reduction) :

$$\text{Removal}_M = \frac{M_{\text{in}} - M_{\text{out}}}{M_{\text{in}}}$$

with $M = C \times V$

Concentration (TSS)

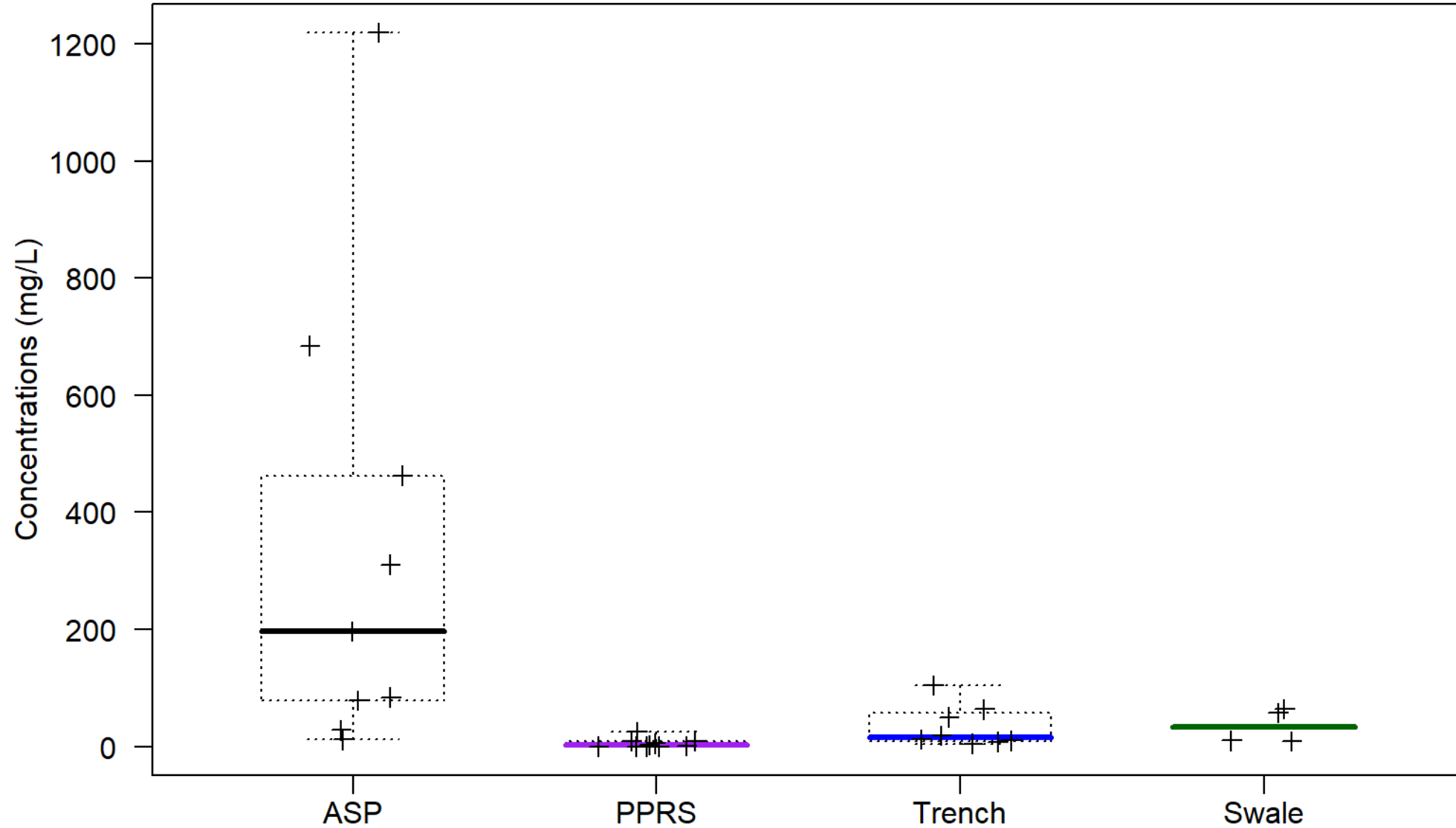

Concentration (Cu)

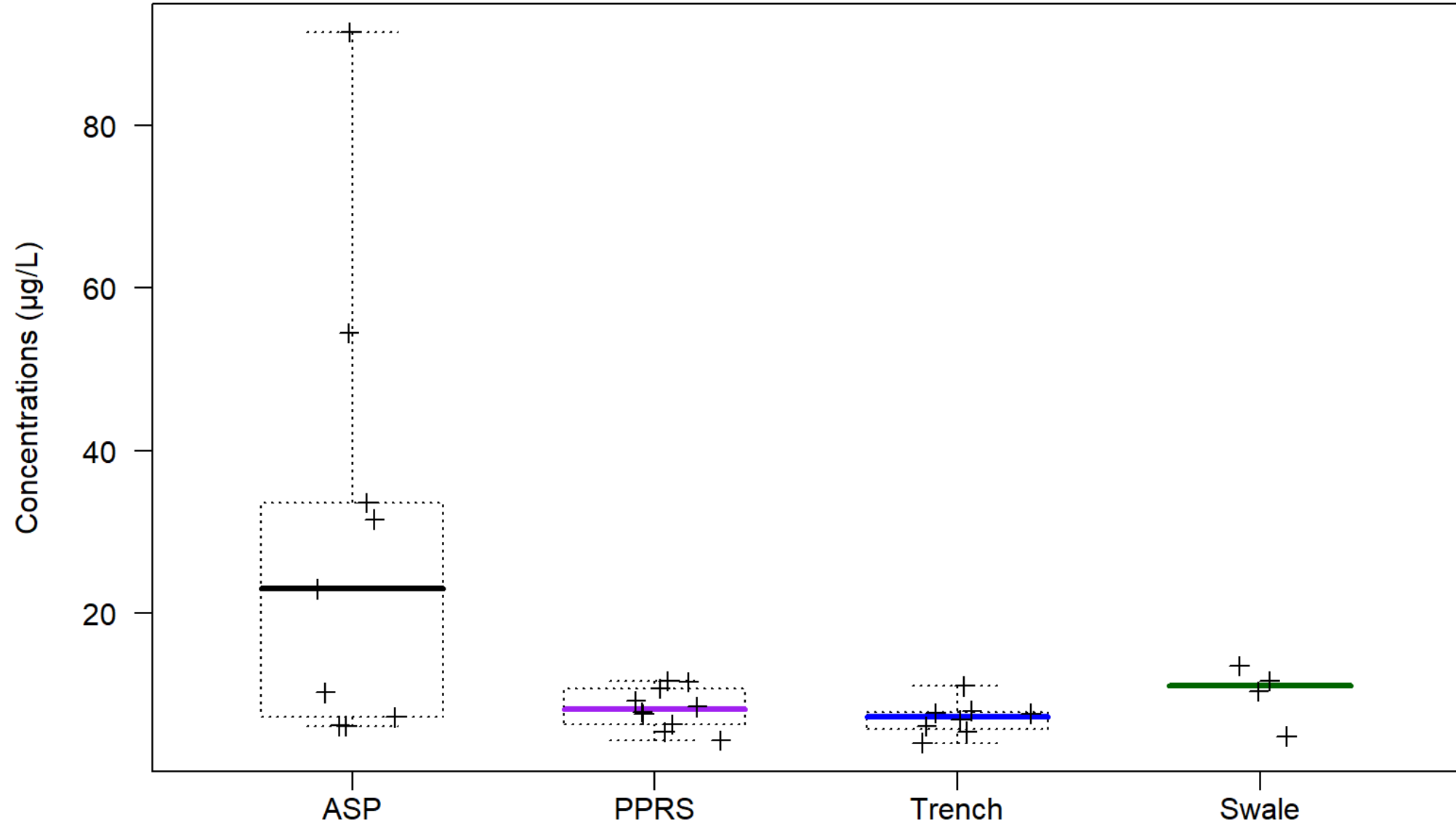

Concentration (BPA)

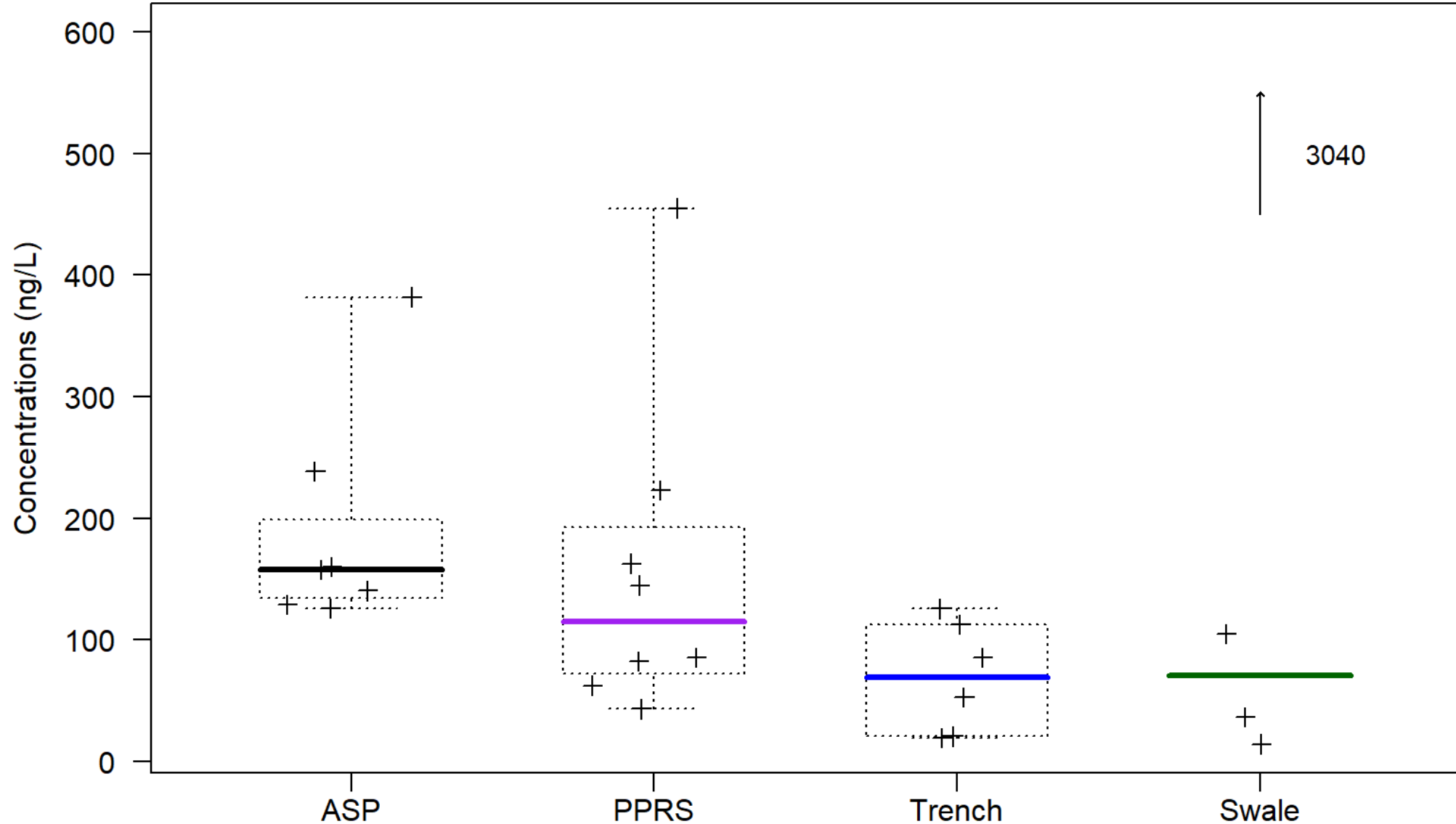

Volume Reduction

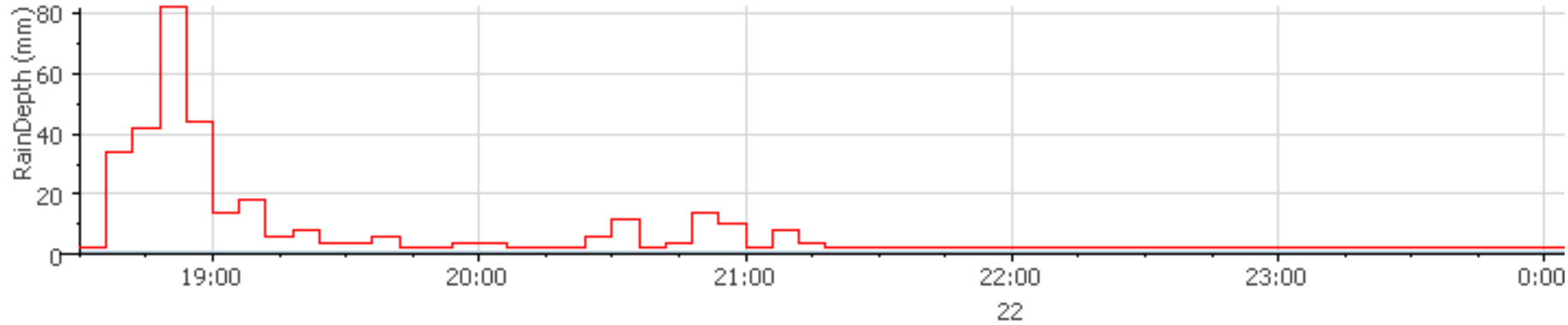

Rain

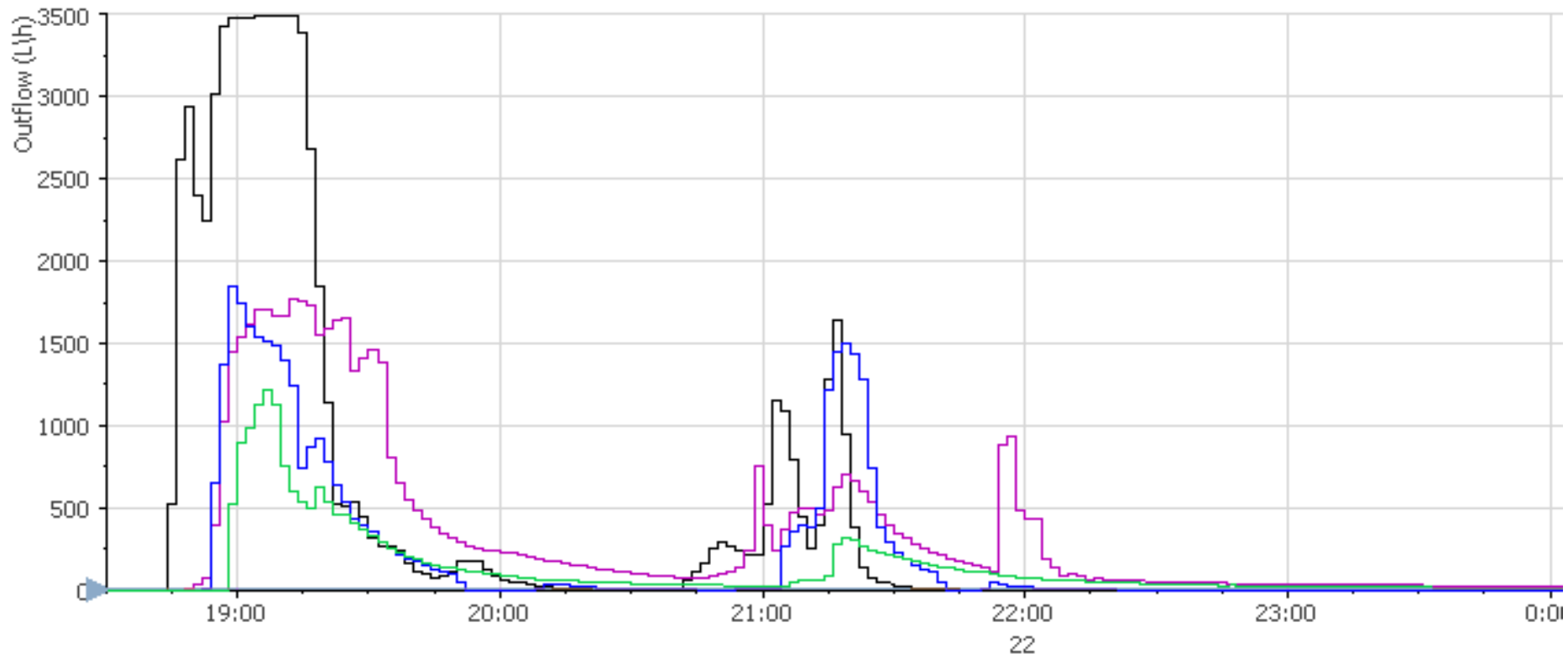

ASP

PPRS

Trench

Swale

Volume Reduction

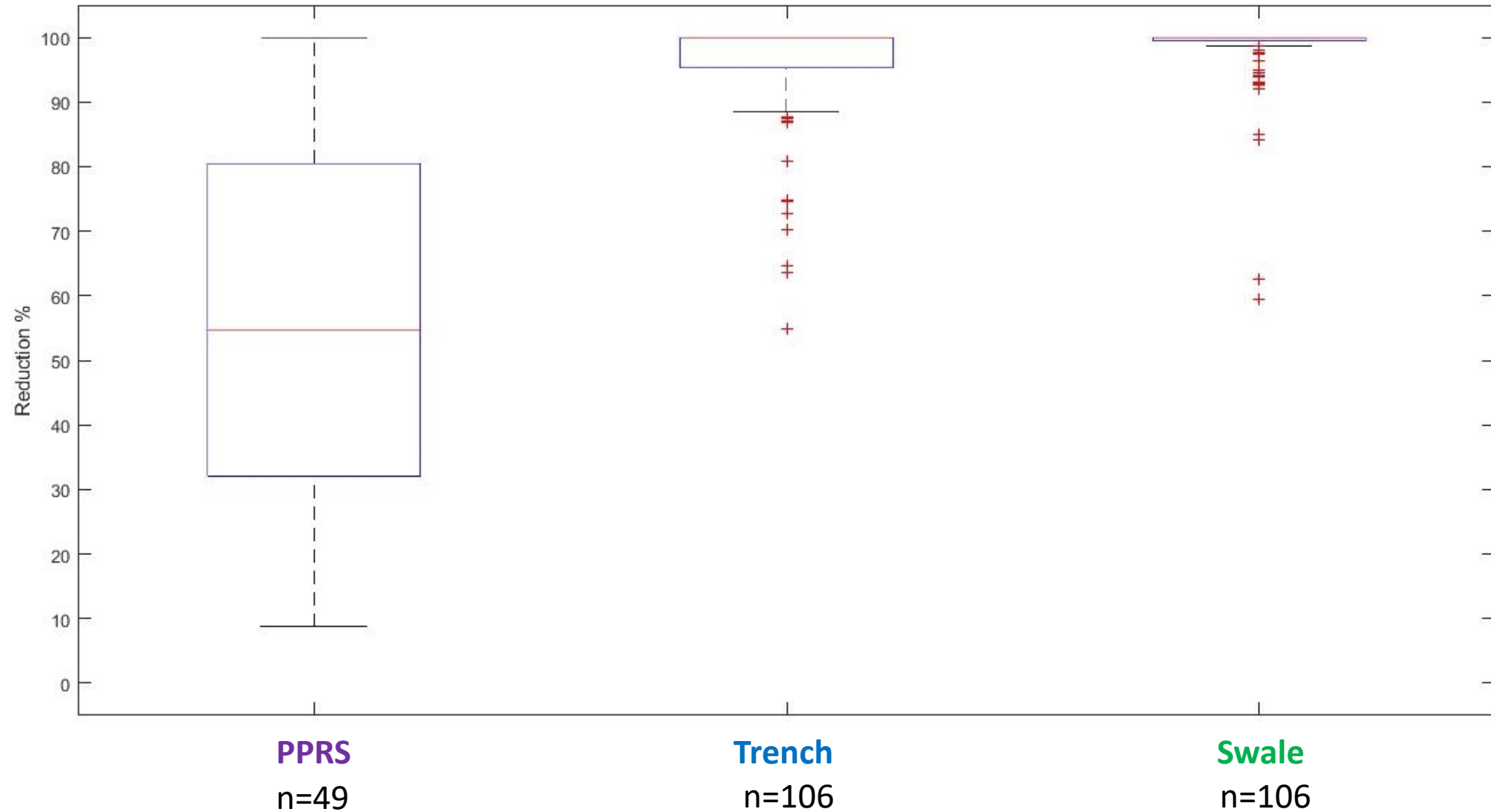

Volume Reduction

- PPRS : Volumetric efficiency = 55%
but quasi-systematic outflow
- Trench : Volumetric efficiency = 97%
52% of events without outflow
- Swale : Volumetric efficiency = 99%
64% of events without outflow

Total Fluxes Reduction (TSS)

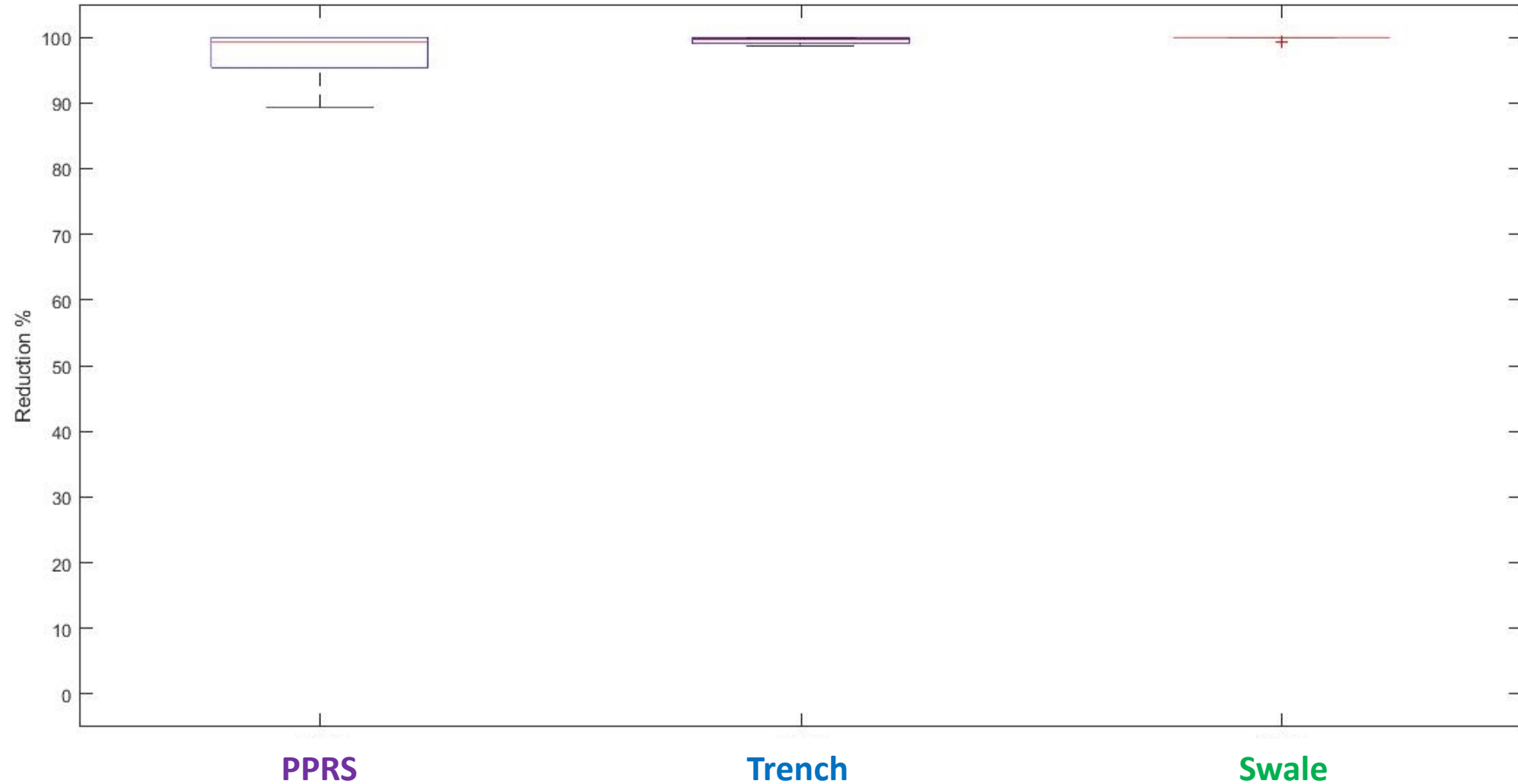

Total Fluxes Reduction (Cu)

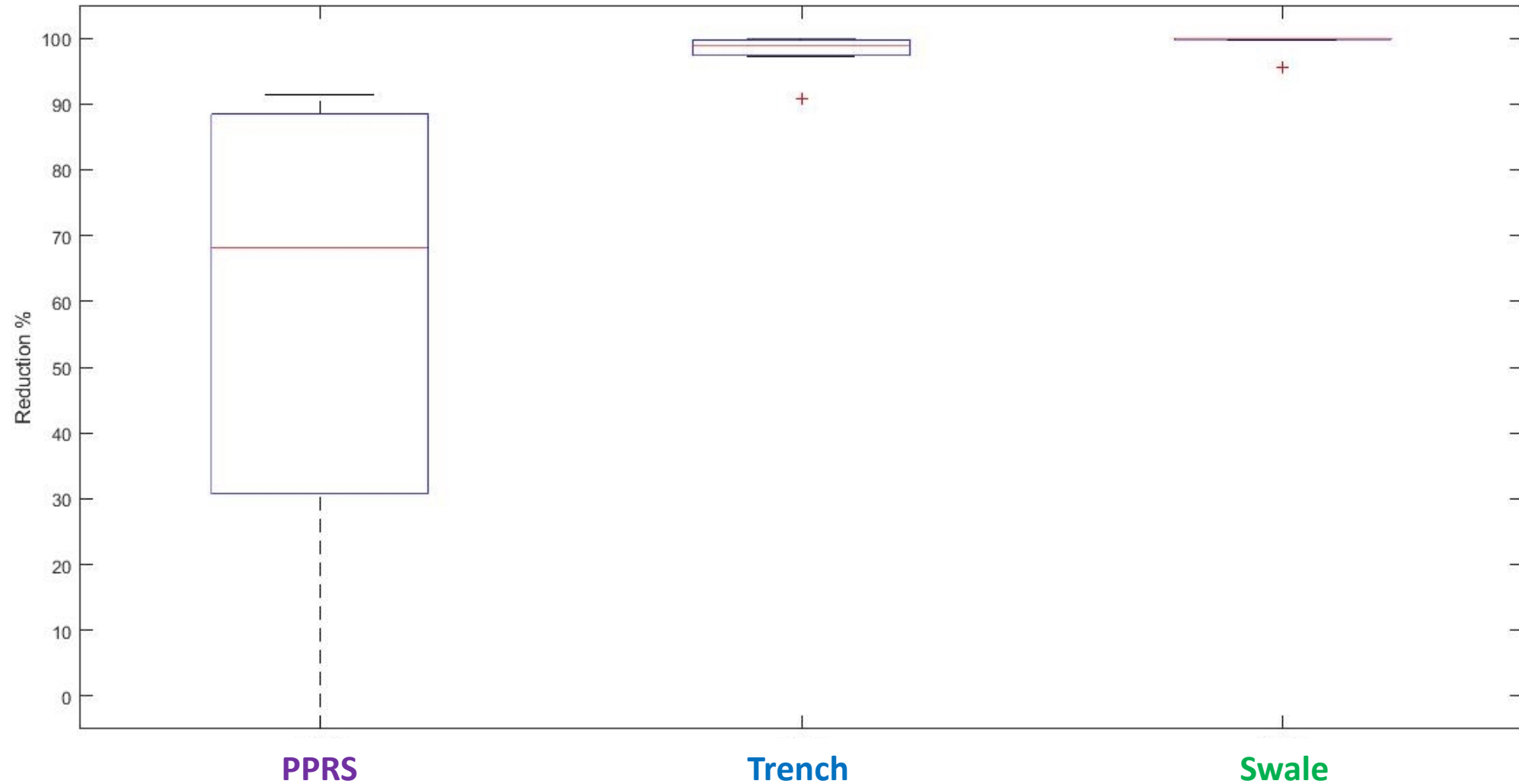

Total Fluxes Reduction (BPA)

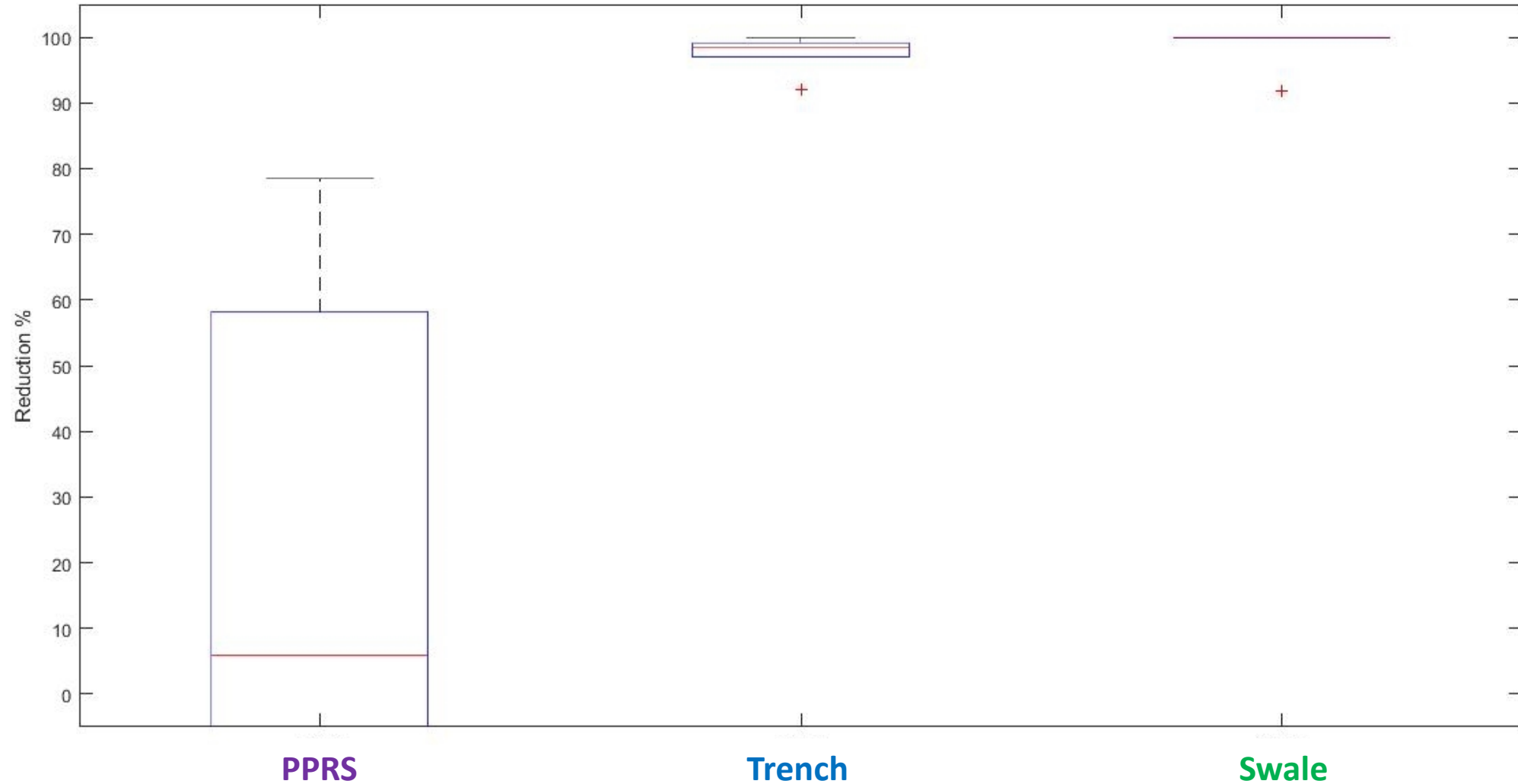

Conclusion 1

- SUDS are efficient regarding runoff water quantity management
- SUDS show good performances regarding runoff water quality management (particulate phase +)

Conclusion 2

- Promising propensity of SUDS to reduce pollutants discharges (particulate and dissolved)

Conclusion 2

- Promising propensity of SUDS to reduce pollutants discharges (particulate and dissolved)
- Analyzes and deconvolution of the processes involved in stormwater management in SUDS is important

Conclusion 2

- Promising propensity of SUDS to reduce pollutants discharges (particulate and dissolved)
- Analyzes and deconvolution of the processes involved in stormwater management in SUDS is important
- Don't forget that SUDS are hydraulic structures → main contribution to pollution management is water retention capacity

Thank you.