



HAL
open science

LISA AIVT Optical Ground Support Equipement technology developments

Jean-Pierre Baronick, Fabio Cortavarria, Stéphane Dheilly, Hubert Halloin,
Corinne Juffroy, Matthieu Laporte, Jean Lesrel, Guy Monier, Pierre Prat,
Aymeric van De Walle, et al.

► **To cite this version:**

Jean-Pierre Baronick, Fabio Cortavarria, Stéphane Dheilly, Hubert Halloin, Corinne Juffroy, et al..
LISA AIVT Optical Ground Support Equipement technology developments. Gravitational-Wave Ad-
vanced Detector Workshop, May 2023, La Biodola (Isola d'Elba), Italy. 2023. hal-04161565

HAL Id: hal-04161565

<https://hal.science/hal-04161565>

Submitted on 13 Jul 2023

HAL is a multi-disciplinary open access archive for the deposit and dissemination of scientific research documents, whether they are published or not. The documents may come from teaching and research institutions in France or abroad, or from public or private research centers.

L'archive ouverte pluridisciplinaire **HAL**, est destinée au dépôt et à la diffusion de documents scientifiques de niveau recherche, publiés ou non, émanant des établissements d'enseignement et de recherche français ou étrangers, des laboratoires publics ou privés.

Public Domain



Context

- LISA based on heterodyne laser interferometry -> measure tiny change distance between free-falling mirrors
- LISA strain sensitivity: $1 \cdot 10^{-20} \sqrt{\text{Hz}}$
- LISA displacement sensitivity: $10 \cdot 10^{-12} \text{ m} / \sqrt{\text{Hz}}$ over $2.5 \cdot 10^9 \text{ m}$
- France is in charge of the Interferometric Detection System (IDS) tests and Optical Test System (OTS)
- Specific test equipments to verify the requirements

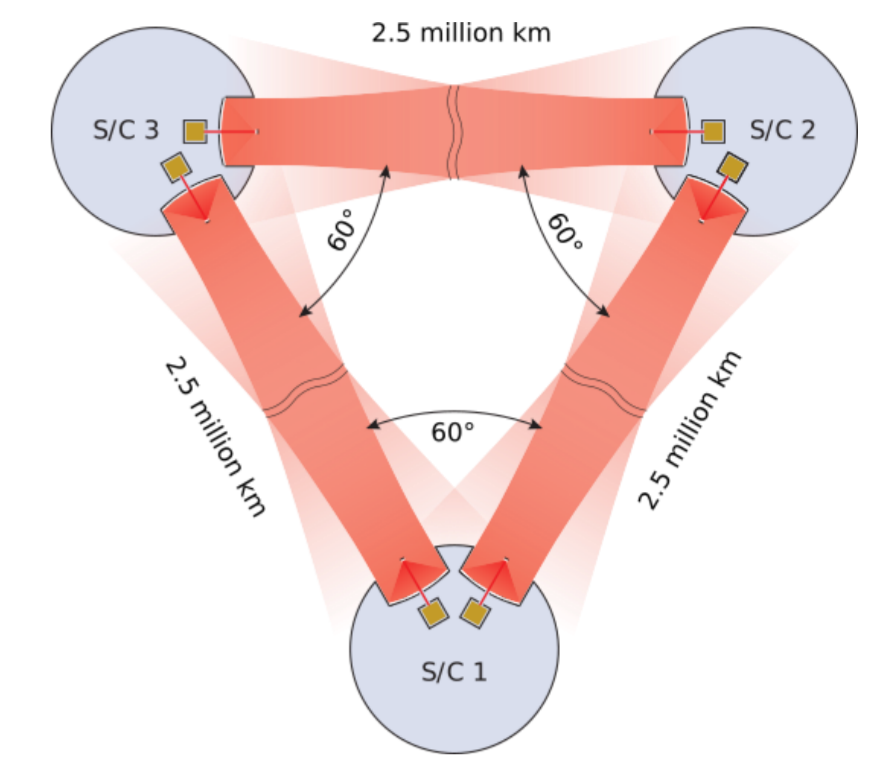

MIFO: Metalic InterFEROmeter

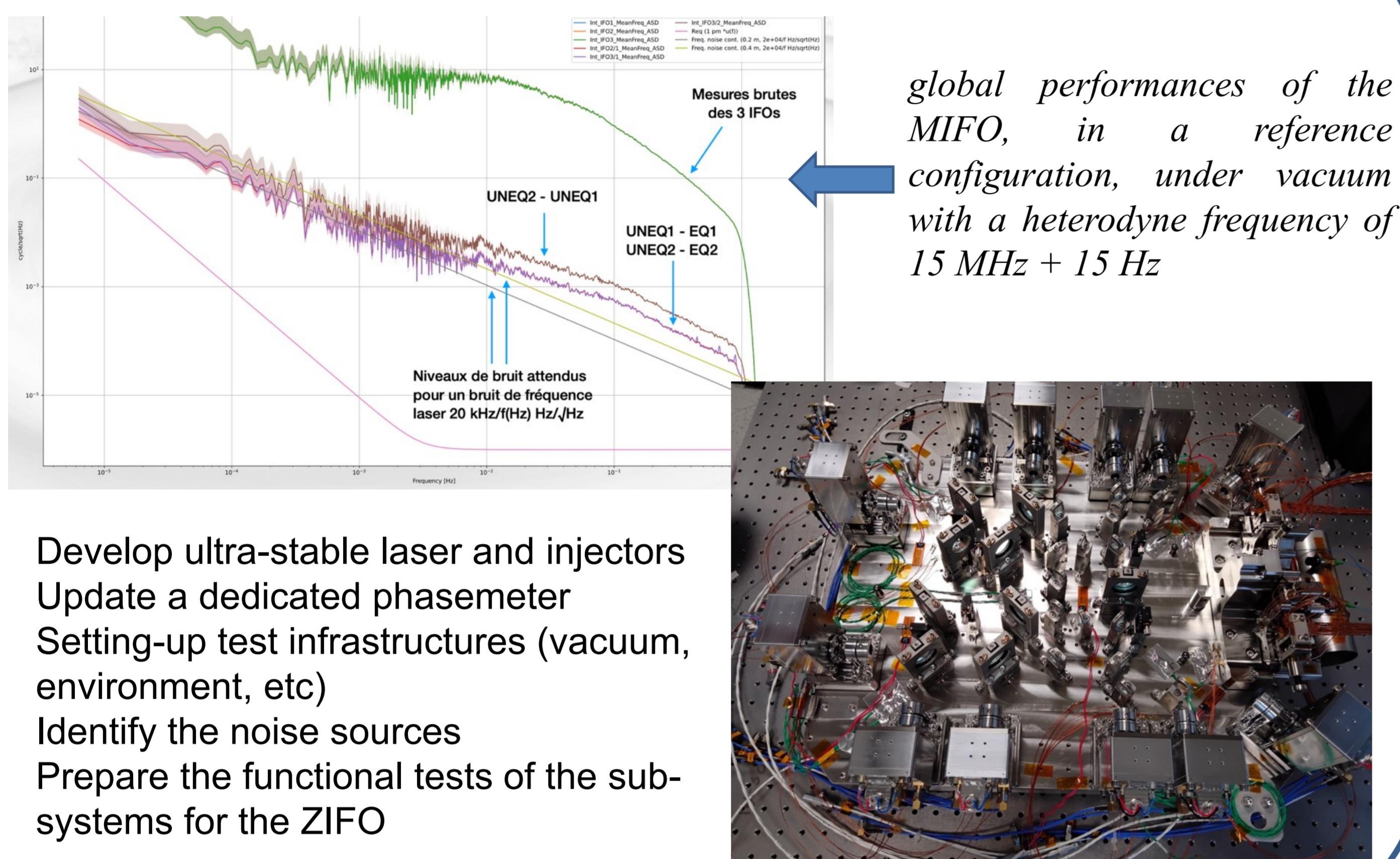

global performances of the MIFO, in a reference configuration, under vacuum with a heterodyne frequency of 15 MHz + 15 Hz

- Develop ultra-stable laser and injectors
- Update a dedicated phasemeter
- Setting-up test infrastructures (vacuum, environment, etc)
- Identify the noise sources
- Prepare the functional tests of the sub-systems for the ZIFO

ZIFO: Zerodur InterFEROmeter

Dimensions: 530 x 450 x 47 mm

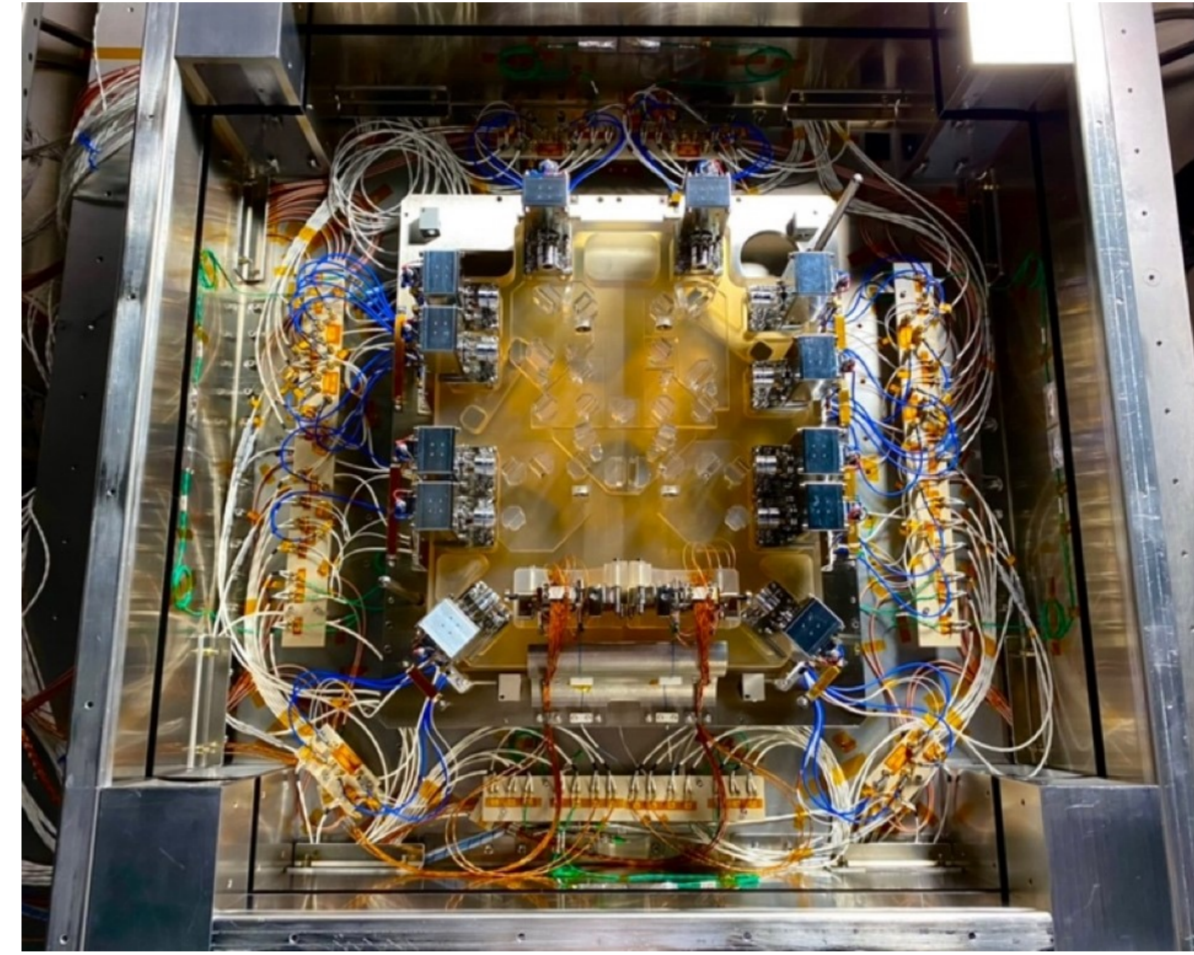

- Develop a demonstration bench
- Determine the excess level of metrology stability -> objective $5\text{-}10 \text{ pm} / \sqrt{\text{Hz}}$ in the band 1-10mHz
- Evaluate the performance limits achievable with the optical contacting

- 3 interferometers:
 - 1 with equal arms
 - 2 with unequal arms

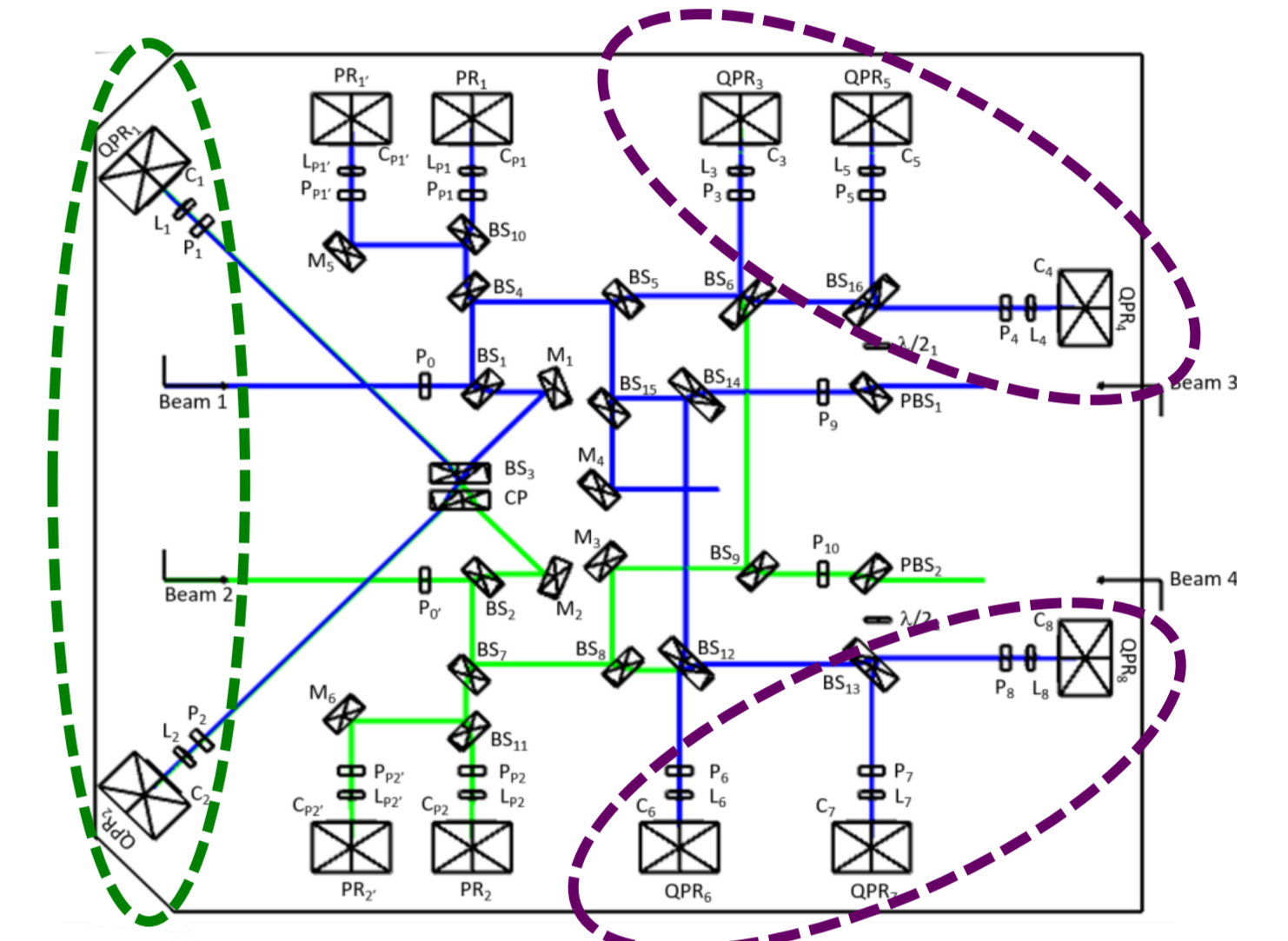

Optical simulations: Optocad, Zemax®

TTL-OB: Tilt-To-Length measurements

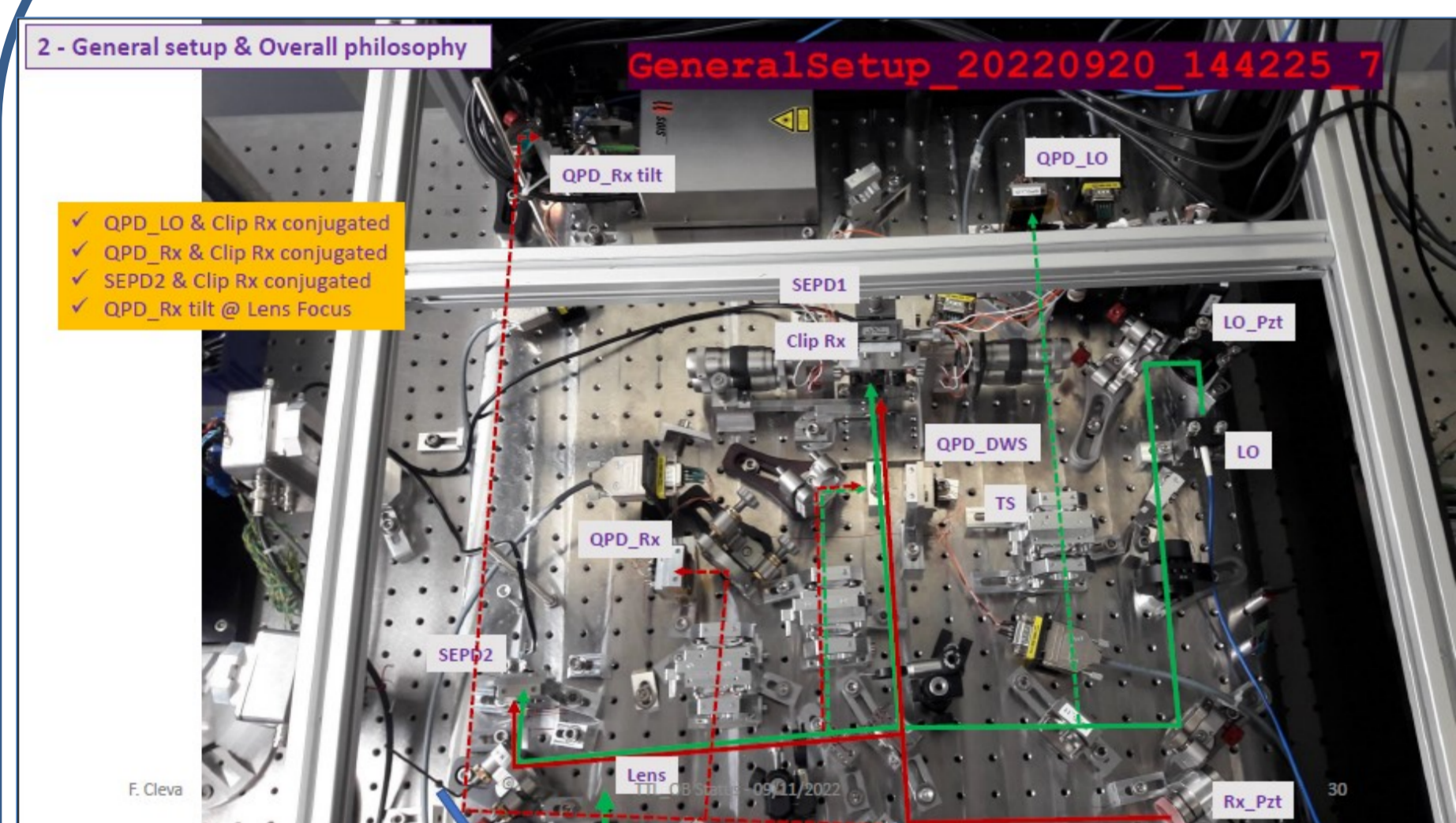

TTL measurements over 100 hours, with a stability of +/- 0.2µm

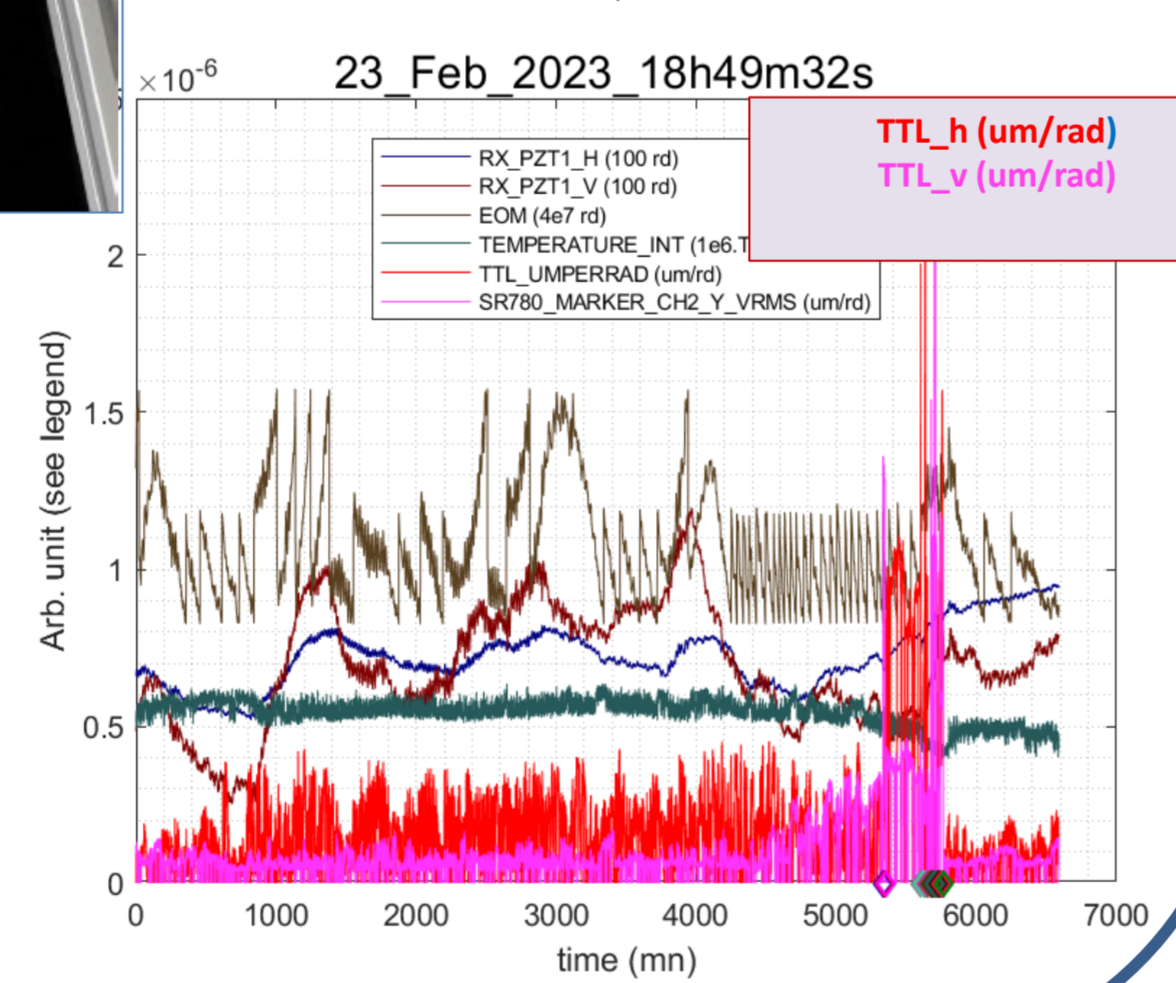

- FF-OGSE shall measure TTL coupling -> develop a bench to demonstrate the feasibility
- Accuracy of the measurement: $< 0.77 \mu\text{m}/\text{rad}$
- Deliver Rx (flat-top) and REF beams, receive Tx beam
- Heterodyne detection scheme

SLOGSE: Stray light measurements

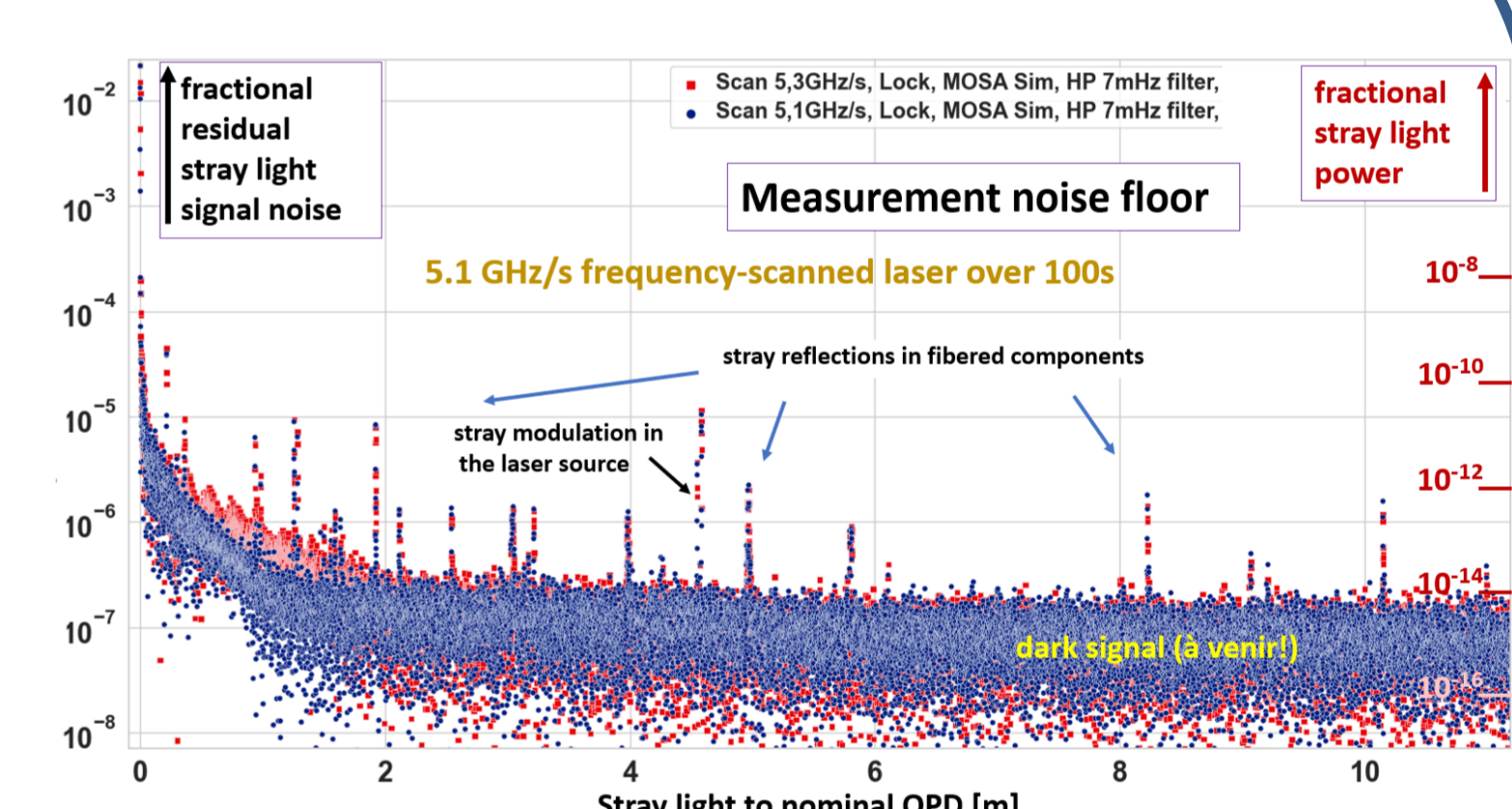
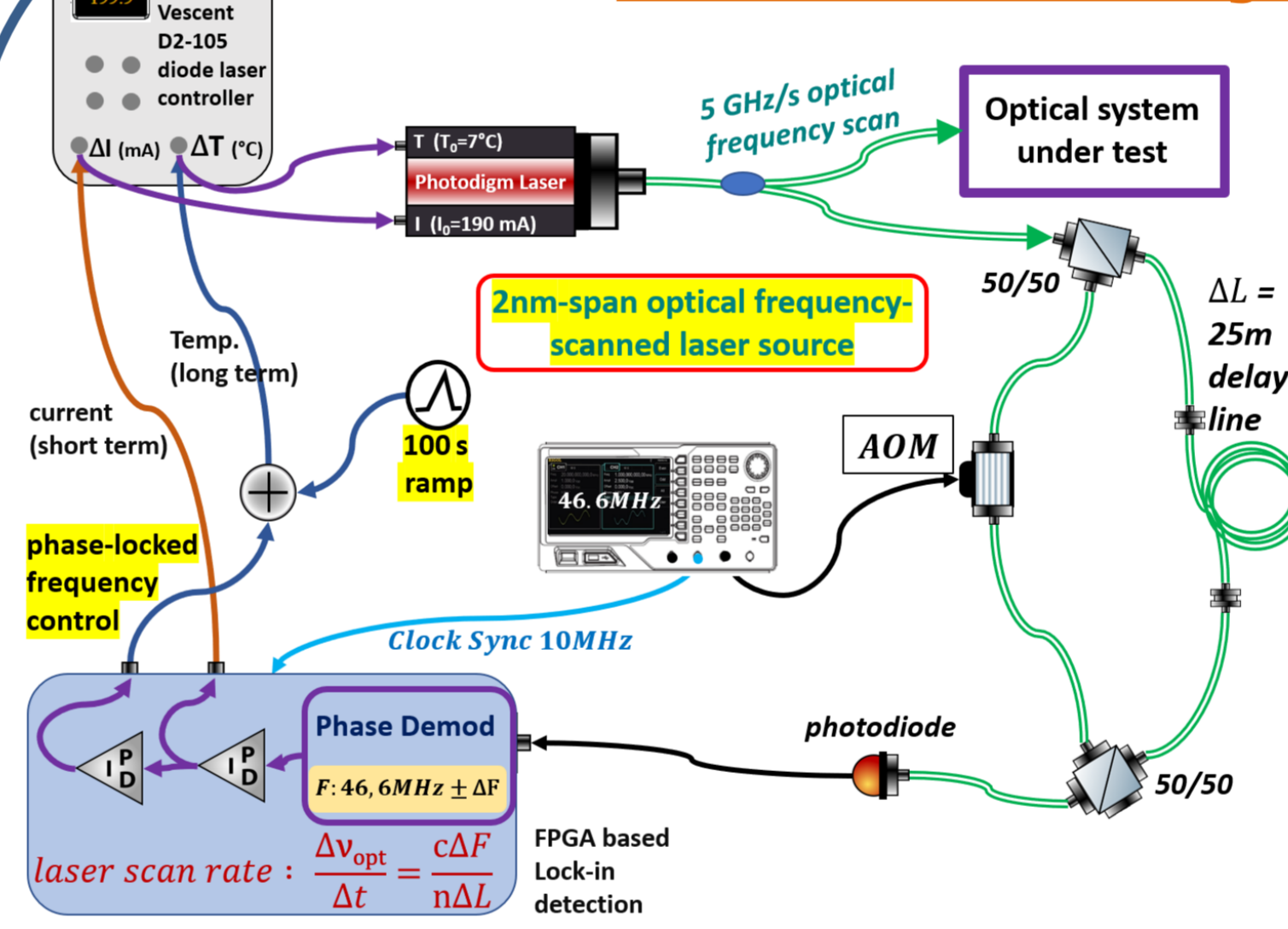

- Phase-locked frequency-scanned laser source
- 2 nm span, over 100 s: 5 GHz/s scan
- Detection noise floor $< 10^{-12}$ in fract. stray light power, degrades at $\Delta L/2 < 25\text{cm}$
- Work under way to eliminate power modulations due to the set up's fibered components

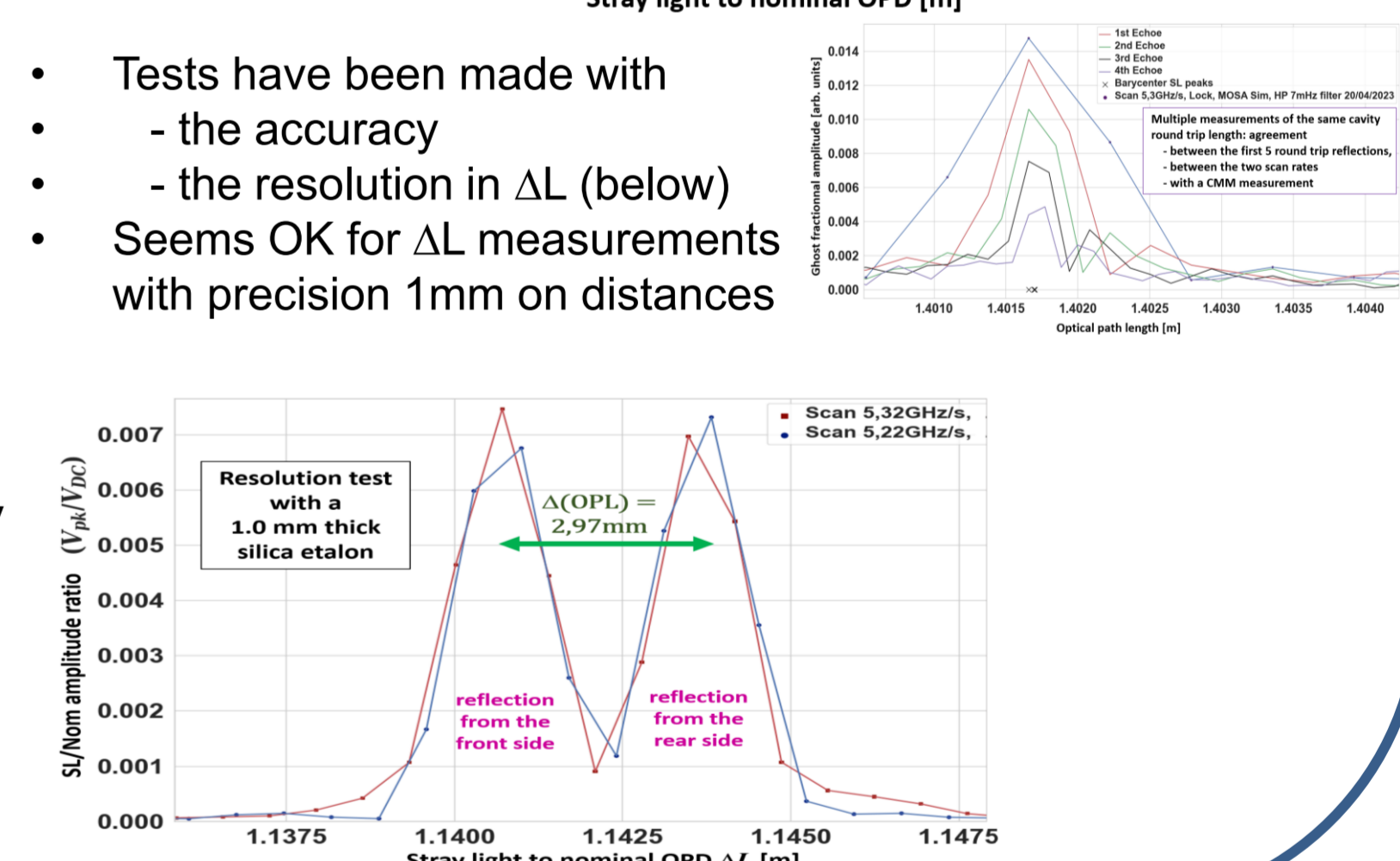

Conclusions & prospects

- France is in charge of the IDS tests and OTS
- Several OGSEs are needed to test the IDS and the MOSA
- First prototypes are under development to test:
 - The sub-systems as laser, injectors, phasemeters, control/command
 - Assess the limits on sensitivity of the set-up and the precision of the path length measurements achievable on ground
 - Identify the noise sources
 - Measure the TTL coupling
 - Measure the straylight at system level, component by component
- Further investigation are ongoing to validate all the objectives
- Preparation of the final OGSE are in progress

Contributors

- APC:** J-P. Baronick, F. Cortavarria, S. Dheilly, H. Halloin, C. Juffroy, M. Laporte, J. Lesrel, G. Monier, P. Prat, A. Van De Walle, M. Vincent, T. Zerguerras
- ARTEMIS:** S. Bruhier, F. Cleva, J-P. Coulon, N. Dinu-Jaeger, T. Friess, D. Huet, B. Lefevre, M. Lintz, M. Merzougui, M. Nardello, M. Pichot, A. Pouzolles, A. Roubeau-Tissot, I. Thiellement, J-Y. Vinet
- CEA:** N. Arab, A. Arhancet, D. Bachet, M. Besançon, N. Besson, R. Granelli, M. Lacroix, A. Petiteau, C. Pitte, S. Sube
- CNES:** R. Arguel, E. Courau, J-C. Damery, F-X. Esnault, O. Grosjean, R. Llorca-Cejudo, E. Rivière
- CPPM:** M. Dupont, L. Guevara, E. Kajfasz, O. Llido, Ch. Meessen, A. Rivière, J. Royon, A. Secroun, J. Zoubian
- L2IT:** C. Buy
- LAM:** M. Carle, C. Fabron, B. Foulon, J.L. Gimenez
- SYRTE:** O. Acef, A. Mehlman, P. Wolf

Funding: CNES, CNRS/INSIS, OCA, Région Sud, UCA