



HAL
open science

Performance of PV array configurations under dynamic partial shadings

Chuanyong Shao, Anne Migan-Dubois, Demba Diallo

► **To cite this version:**

Chuanyong Shao, Anne Migan-Dubois, Demba Diallo. Performance of PV array configurations under dynamic partial shadings. EPJ Photovoltaics, 2023, 14, pp.21. 10.1051/epjpv/2023012 . hal-04154753

HAL Id: hal-04154753

<https://hal.science/hal-04154753>

Submitted on 6 Jul 2023

HAL is a multi-disciplinary open access archive for the deposit and dissemination of scientific research documents, whether they are published or not. The documents may come from teaching and research institutions in France or abroad, or from public or private research centers.

L'archive ouverte pluridisciplinaire **HAL**, est destinée au dépôt et à la diffusion de documents scientifiques de niveau recherche, publiés ou non, émanant des établissements d'enseignement et de recherche français ou étrangers, des laboratoires publics ou privés.

Performance of PV array configurations under dynamic partial shadings

Chuanyong Shao^{*}, Anne Migan-Dubois, and Demba Diallo

Université Paris-Saclay, CentraleSupélec, CNRS, GeePs, 91192 Gif-Sur-Yvette, France

Received: 3 March 2023 / Received in final form: 2 May 2023 / Accepted: 16 May 2023

Abstract. The partial shading effect (PSE) is responsible for most power losses in a photovoltaic (PV) system. By modifying the interconnections between PV modules, called PV array reconfiguration, it is possible to improve the power output under partial shading conditions (PSCs). Compared to research on static PSCs, the impact of dynamic PSCs on PV arrays is rarely mentioned, although it deserves to be studied. This paper studies the dynamic PSE on four traditional PV configurations and two reconfiguration techniques based on a 5×5 PV array. The four traditional PV configurations are Series-Parallel (SP), Bridge-Link, Honey-Comb, and Total-Cross-Tied (TCT). The two reconfiguration techniques are SuDoKu (SDK) representing Physical Array Reconfiguration (PAR) and Electrical Array Reconfiguration (EAR). The dynamic PSCs are simplified to three types based on the varying orientation: horizontal, vertical, and diagonal. Simulations are carried out with Matlab & Simulink. The performance comparison for the four traditional PV array and two reconfiguration techniques is based on daily energy losses. The results show that four traditional PV configurations techniques, in all PSCs’ scenarios, EAR has the most stable performance and the lowest energy losses. The energy losses of SP connection are the largest in all PSCs cases. Although their performance varies depending on the partial shading case, Total-Cross-Tied and SudoDKu lead to the lowest energy losses.

Keywords: Dynamic partial shading / PV array reconfiguration / energy loss

1 Introduction

From 22 onwards, all new buildings have to be Near Zero Energy Buildings, otherwise, 75% of EU buildings were built before energy performance standards existed and the refurbishment rate of buildings need to increase threefold for the decarbonization targets to be reached [1]. A building Integrated PV (BIPV) provides new solutions to achieve the ambition of the clean energy projects in EU. By 2021, although the share of the BIPV has only achieved 2% over all PV installations, it still has a great developing potential [1].

In urban areas, partial shading is one of the most important factors causing energy losses in BIPV system [2]. The shading could be caused by adjacent buildings, chimney, trees, moving clouds, etc. The author in [3] shows that partial shading produced by a 2 meters high chimney could contribute to 2–12.5% annual energy losses for of a cut wafer-Si based solar system.

Research works prove that altering the interconnections among PV modules helps to improve the output performance of a PV array under partial shading conditions (PSCs). This is known as PV reconfiguration techniques. The traditional PV configurations including Series-Parallel (SP), Bridge-Link (BL), Honey-Comb (HC), and Total-Crossed-Tied (TCT) [4–7] can mitigate the power loss under PSCs. Authors in [4] present detailed modeling and simulation to estimate the performance of Series, Parallel, SP, BL, HC, and TCT under PSCs. The performance assessment is based on various shading patterns. The authors in [4] found that the higher the number of connections in series, the greater the power loss. Nevertheless, it is found that the performance of the previously mentioned PV configurations is highly sensitive to the shading pattern, even for TCT, which has the best performance [4,8]. To improve the performance (minimize the power loss), PV reconfigurations are developed. They improve the performance of PV arrays under PSCs by adjusting the current through the electrical lines. There are two main PV reconfiguration techniques: a static one denoted Physical Array Reconfiguration (PAR), and a dynamic one that is Electrical Array Reconfiguration

^{*}e-mail: chuanyong.shao@centralesupelec.fr

Table 1. The comparison between PAR and EAR.

Type	Advantages	Drawbacks
PAR	Does not require any sensors' reconfiguration algorithm or switching matrix, in opposition to the dynamic technique case [17]. Past method, the first column of the reconfigurable patterns remains unaltered [17].	The location of the modules in the TCT network is changed according to the skyscraper model in one go for all shadings [16]. This method requires more wiring; this would increase the voltage drop in the PV systems [16]. Shading effects cannot be spread uniformly across every row [16].
EAR	Flexibility Dynamically controllable	The cost increases with a dynamic technique [17]. The configuration becomes complex [17]. The reconfiguration algorithm is complex [18].

(EAR) [9]. Equalizing the irradiance in each row of the PV array is the most commonly used method to achieve reconfiguration [7]. Regarding PAR, the module's physical positions are rearranged without altering the electrical connections [9]. Typical PAR methods apply puzzle-solving ideas to distribute the shading, such as SuDoKu (SDK), Zig-Zag, Magic Square, etc. [10–12]. The authors in [10] propose to rearrange the PV modules vertically in a TCT-based configuration using the SDK algorithm, under different PSC patterns. Their results showed that SDK has a better output power than the original TCT configuration. However, PAR is a one-shot design, which is not flexible enough to handle time-varying PSCs.

Thus, the EAR is proposed to solve this problem [13]. In the EAR, the PV module position is fixed. The EAR uses groups of switches to change the interconnections between the PV modules in real-time. There are also some adaptive hybrid configuration systems, such as models in [14,15]. The authors in [16] designed an EAR method through the simulated annealing algorithm, which minimized the current difference in each row of the PV array. The results showed that EAR performs better than TCT and SDK. However, the EAR technique requires high switch resolution and is more expensive than the PAR system [7]. Table 1 summarizes their main characteristics.

Despite the extensive literature, the effectiveness of reconfiguration in the case of dynamic shading has received little attention. In most cases, the performance of a PV array under PSCs is evaluated by comparing the power loss under several static PSC scenarios [9,19]. The power loss could indicate the performance of the PV arrays under some PSCs, but it is not enough to evaluate the performance of a PV array over a long time. The shape of the shading that changes continuously in real life is defined as Dynamic PSCs (D-PSCs) in this paper.

The objectives of this work are to compare the effectiveness of the PAR and EAR under dynamic PSCs, and evaluate under dynamic PSCs scenarios the performance of the PV array with different reconfiguration techniques through energy loss analysis.

This paper uses daily energy loss to evaluate the performance of different PV configurations and reconfiguration techniques under D-PSCs. In the D-PSCs cases, the shape of the shadow can shrink or extend in one direction. In this paper, assumptions of the D-PSCs are made

according to the direction of the varying shadow. Three directions (Horizontal, Vertical, and Diagonal) of the PSCs' varying will be considered. Their effects on various reconfigured layouts (the four typical PV configurations, PAR and EAR) will be evaluated. The irradiance data are obtained from the PVGIS database. The output performance of different PV reconfiguration techniques will be compared based on daily energy losses analysis.

2 Theory of partial shading effect

A PV array configuration defines the way in which the PV modules are interconnected [20]. The advanced PV configurations are developed from the elementary structures. The basic architectures of a PV array are series connection and Parallel connection (Figs. 1a, 1b). In Figure 1, G1 and G2 are two identical PV modules. A series-connected set of PV modules is defined as a PV string, while the parallel-connected one is a PV block. The combination of series and parallel connections forms the PV array. D1 and D2 are diodes connected to the PV modules. In Figure 1a, the two PV modules are in series, and a parallel-connected diode accompanies each PV module. In Figure 1b, the two PV modules are in parallel, and a series-connected diode is associated to each PV module. In the series-connected PV modules, the diodes are called bypass diodes, while in the parallel-connected PV modules, they are blocking diodes (anti-reverse diodes).

To better understand the PSCs on different PV configurations, this section illustrates the operating mechanism for the two basic PV configurations. The analysis starts with a uniform irradiance condition before tackling the PSCs. The basic PV configurations refer to the PV layouts in Figures 1a and 1b. The analysis is based on the PV panel model in Simulink. Figure 1c is the classical equivalent electrical circuit single-diode model. Figures 1d, 1e, 1f represent a single PV model, a series-connected PV configuration model, and a parallel-connected PV configuration built in Simulink, in which the DC source acts as a load by adjusting the output voltage. Table 2 states the electrical parameters of the PV modules G1 and G2. The output characteristics of the PV modules are represented by the current–voltage ($I-V$) and power–voltage ($P-V$) curves.

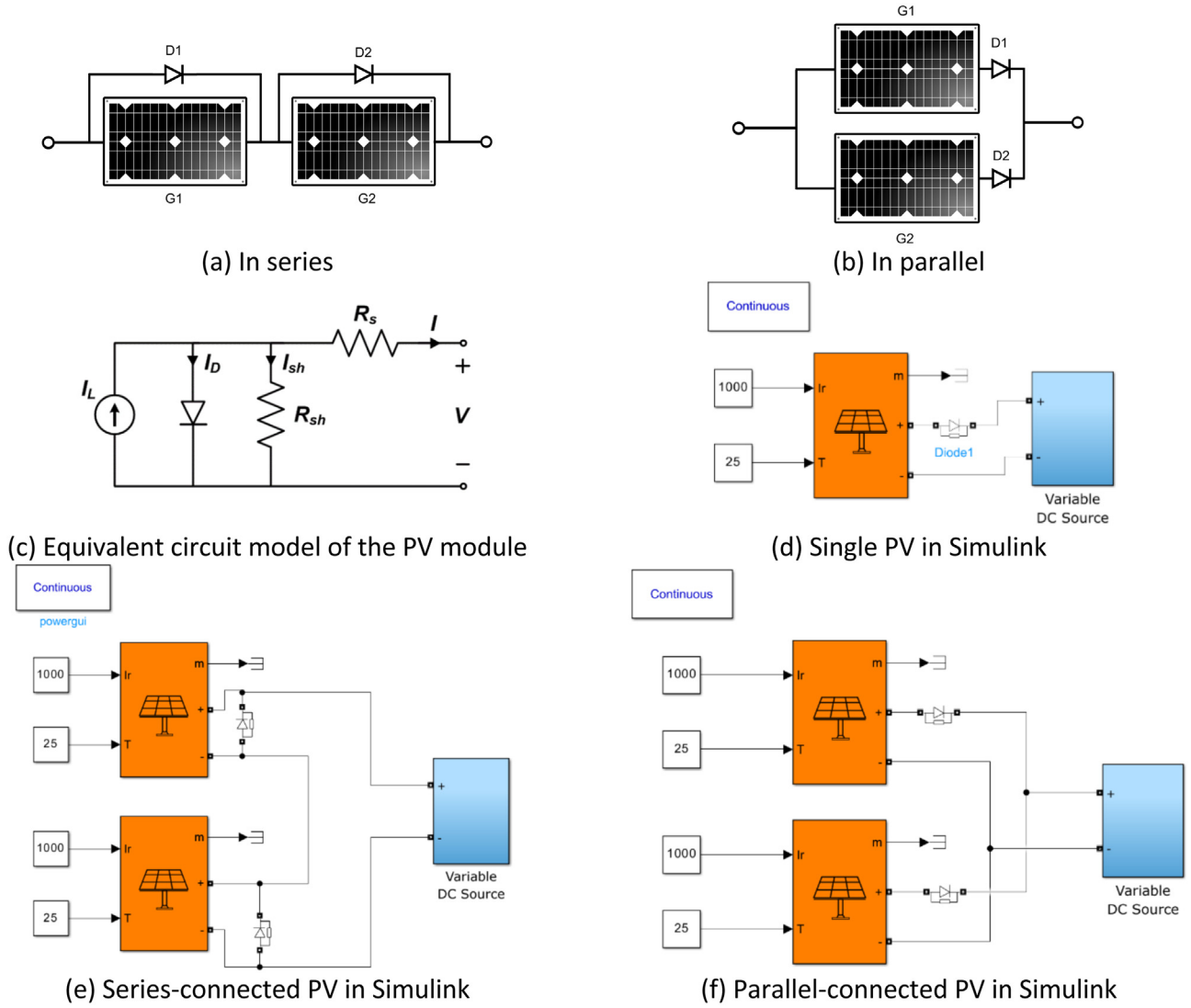

Fig. 1. Models of basic PV configurations.

Table 2. The parameters of the PV module.

Number of cells	V_{oc}	I_{sc}	V_{mp}	I_{mp}	P_m
60	36.3 V	7.84 A	29 V	7.35 A	213.15 W

2.1 Basic PV configuration performance under uniform irradiance

The uniform irradiance condition means that PV modules operate under the same irradiance. Our study does not address the operating temperature of PV modules (constant for all cases and equal to 25 °C). Therefore, we can deduce:

- In a PV string, both PV modules are forward biased with the same output current. Meanwhile, the bypass diodes are reverse biased (not activated). The output voltage V_s

and current I_s of the PV string are given by equations (1), (2). G1 and G2 are identical PV modules leading to equations (2) and (3).

$$V_s = V_{OC1} + V_{OC2}, \tag{1}$$

$$I_s = I_{SC1} = I_{SC2}, \tag{2}$$

$$V_{OC1} = V_{OC2}. \tag{3}$$

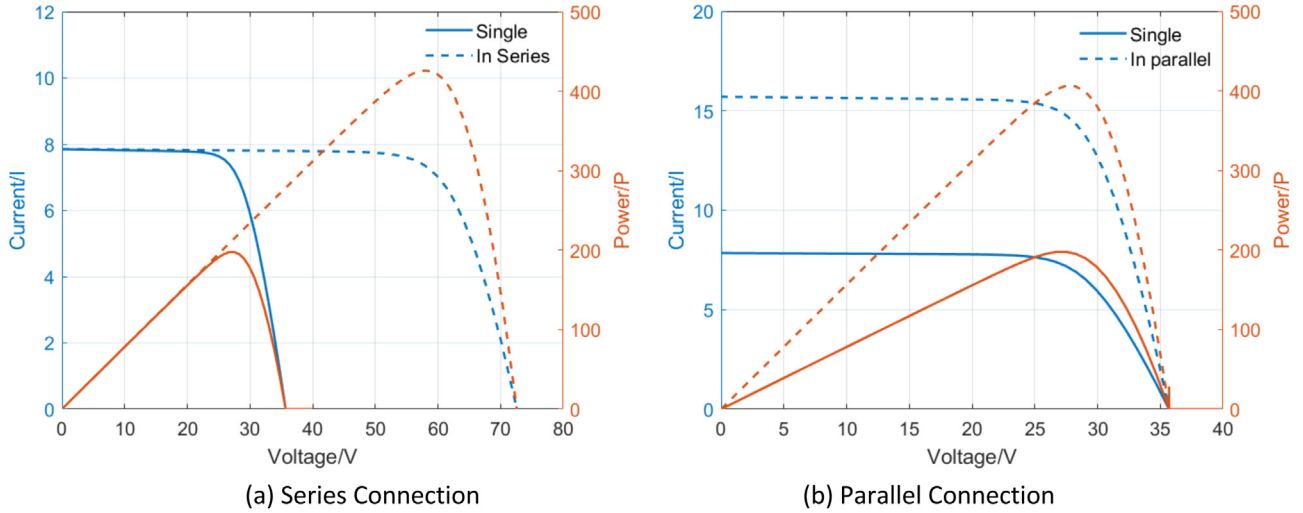

Fig. 2. I - V and P - V curves.

V_{OC1} and I_{SC1} are the open circuit voltage and short circuit current of PV module G1. V_{OC2} and I_{SC2} are the open circuit voltage and short circuit current of PV module G2. Figure 2a presents the I - V curve and P - V curve of the single PV module (solid line) and the PV string (dashed line).

- In a PV block, the parallel connected PV modules generate electricity together and the blocking diodes are forward biased (conductive). The output voltage V_p and current I_p of the PV block are defined in equations (4) and (5):

$$V_p = V_{OC1} = V_{OC2}, \quad (4)$$

$$I_p = I_{SC1} + I_{SC2}, \quad (5)$$

$$I_{SC1} = I_{SC2}. \quad (6)$$

Figure 2b shows the I - V curve and P - V curve of the single PV module (solid line) and the PV block (dashed line). When G1 and G2 operate under uniform irradiance condition, comparing Figure 2a with Figure 2b, the output power of the series structure is dominated by the output current, while it is mainly determined by the voltage in the parallel structure.

2.2 Introduction to the partial shading effect

Partial shading means the PV modules in the same PV array operate under different irradiance conditions. For a single PV module, the short circuit current is proportional to the received irradiance, while the open circuit voltage is almost unaffected.

Under the PSC case, G1 and G2 receive different irradiances, denoted as $IR1$ and $IR2$. The I - V and P - V curves are depicted in Figure 3. Under the PSC, we assume that G2 is shaded, $IR2 < IR1$. G1 and G2 work under the

same temperature. Characteristic curves are obtained from the simulations of the three layouts: single G1 or single G2 and connected G1-G2. The legend of the curves is as follows:

- The solid lines in red refer to the characteristic curves of G1 under irradiance $IR1$.
- The solid lines in green represent the characteristic curves of G2 under irradiance $IR2$.
- The solid black lines indicate the characteristic curves (under PSC) of the connected-G1&G2 group (In string or parallel). The irradiance of G1 is $IR1$, and the irradiance of G2 is $IR2$.
- Controlled simulation: The blue dashed lines are the characteristic curves (Uniform irradiation) of the connected-G1&G2 group (series/string or parallel/blocks). The irradiances of G1 and G2 are $IR1$.

Comparing the blue dashed and the black solid PV curves in Figure 3, no matter the PV connection structure, there is always a power loss under PSC. Multiple Maximal Power Points (MPPs) occur for series-connected PV modules under PSC. Under the diodes' protective function, the output process of the connected PV under PSC can be divided into several stages as described in the following for two basic PV layouts:

For series connection

Stage 1:

- G1 and G2 supply the load together. The output voltage and current change with the varying load.
- Because G1 and G2 are in a series connection, the electrical circuit's total current should be the same according to the Kirchhoff Current Law.
- At this stage, the total current increases close to the current of the Maximum Power point (MPP) of G2.
- The outputs of both PV modules are increasing.

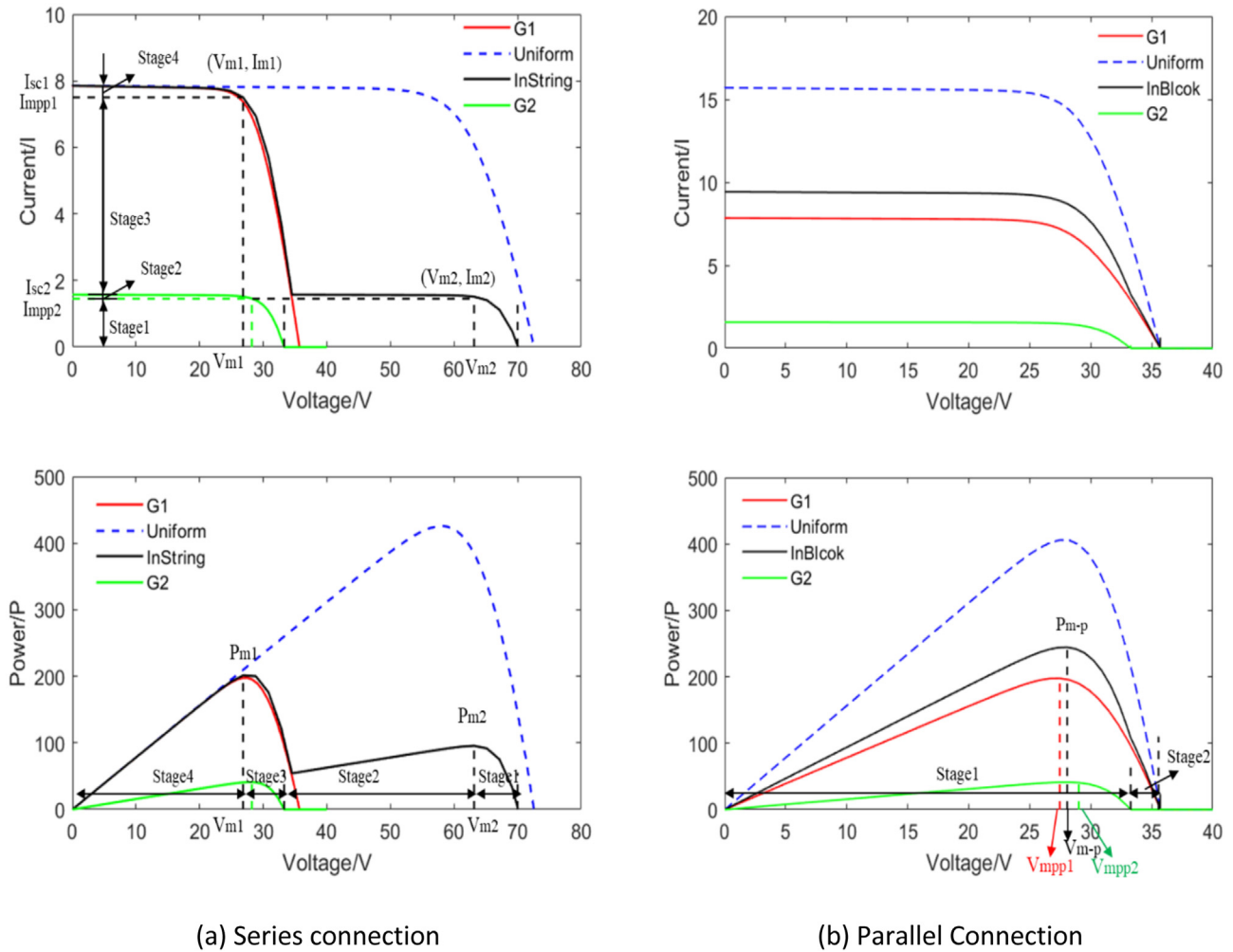

Fig. 3. The partial shading effect on usual PV configurations.

Stage 2:

- The current of G2 goes across the MPP of G2.
- The output currents of the G1 and G2 still grow.
- The output of G1 keeps increasing.
- The output of G2 decreases, as well as the general output power.

Stages 3 and 4:

- The current produced by G1 goes above the short-circuit current of G2, I_{SC2} .
- G2 is reverse-biased, acting as a load, and the diode D2 is conductive under the reverse-biased voltage of G2.
- The diode bypasses G2, and only G1 provides the output power. Before the current produced by G1 reaches its limit I_{mpp1} , the general output power increases again.
- After the current goes across the MPP of G1, the general output will decrease.

For parallel connection

Stage 1:

- G1 and G2 supply the load in a parallel connection. The output voltage and current change with the varying load.
- The total output voltage of the electrical circuit needs to be the same according to the KVL.
- When G1 and G2 work together, the output voltages of G1 and G2 are identical.
- When the voltage is lower than the MPP voltage of G2 (V_{mpp2}), the outputs of both PV modules increase.
- Once the voltage is more significant than the MPP voltage of G2, the output of G2 starts to decrease.

Stage 2:

- The output of G2 drops to zero, and the voltage of G2 is reverse-biased. The voltages of G1 and G2 are no longer equal.

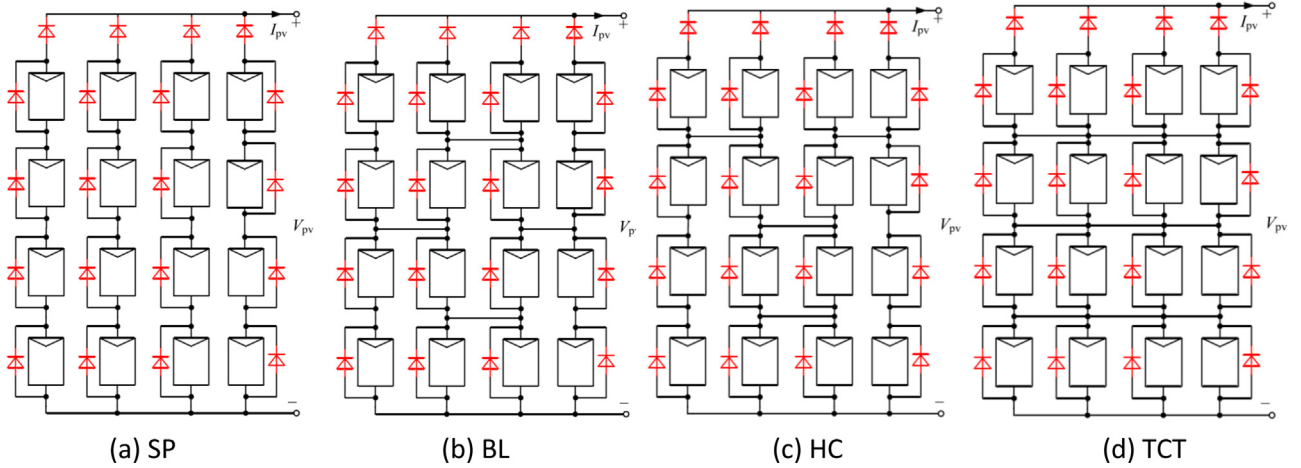

Fig. 4. The four traditional PV configurations.

- The blocking diode protects the PV module from the reverse current, and G2 stops operating.
- Only G1 supplies the output.

Equations (7)–(12) illustrate the output current and voltage of the PV string and PV block under PSCs. The mechanisms on how the PSC affects the operation of the PV string and PV block are presented in Figure 3.

$$I_{s-out} = \begin{cases} I_{G2} & I_{s-out} \leq I_{SC2} \\ I_{G1} & I_{SC2} < I_{s-out} \leq I_{SC1} \end{cases}, \quad (7)$$

$$V_{s-out} = V_{G1} + V_{G2}, \quad (8)$$

$$I_{p-out} = I_{G1} + I_{G2}, \quad (9)$$

$$V_{p-out} = \begin{cases} V_{G2} & V_{p-out} \leq V_{OC2} \\ V_{G1} & V_{OC2} < V_{p-out} \leq V_{OC1} \end{cases}, \quad (10)$$

$$V_{G1} \approx V_{G2}, \quad (11)$$

$$\frac{I_{SC1}}{I_{SC2}} = \frac{I_{R1}}{I_{R2}}. \quad (12)$$

I_{s-out} , V_{s-out} are the output current and voltage of the PV string.

I_{p-out} , V_{p-out} are the output current and voltage of the PV block.

I_{G1} , I_{G2} are the load currents of PV modules G1 and G2, respectively.

V_{G1} , V_{G2} are the load voltages of PV modules G1 and G2, respectively.

I_{R1} , I_{R2} are the in-plane irradiances received by PV modules G1 and G2, respectively.

2.3 The four traditional PV configurations

Based on the analysis in Sections 2.1 and 2.2, we observe that the performance losses under partial shading are different for the two primary configurations. Therefore, it is

necessary to analyze the performance of the complex configurations, which is done in the following. The four most used PV configurations (Fig. 4) are: Series-Parallel (SP), Bridge-Link (BL), Honey-Comb (HC), and Total-Cross-Tied (TCT). For a PV array with $M \times N$ dimension, the definitions for the four traditional PV configurations are explained as follows.

2.3.1 The SP configuration

The series-parallel PV configuration is presented in Figure 4a. M PV modules are connected in series to form a string, then N strings are connected in parallel to generate the final output power.

2.3.2 The BL configuration

In the Bridge-Link PV configuration, every two sets of the series connected modules are then connected in parallel with each other, as shown in Figure 4b.

2.3.3 In HC configuration

In the Honey-Comb PV configuration, presented in Figure 4c all the PV modules are interconnected in a hexagonal shape similar to a honey comb [5].

2.3.4 In TCT configuration

The Total-Cross-Tied PV configuration is derived from a SP connection, shown in Figure 4d. In TCT connection, N PV modules are parallel connected to form M PV blocks. Those blocks are then series connected to supply the electricity to the external circuit.

2.4 The two PV reconfiguration techniques

Besides the four traditional PV configurations, there are two PV reconfiguration techniques. Compared to the traditional PV configurations, PV reconfiguration techniques improve the performance of the PV array under

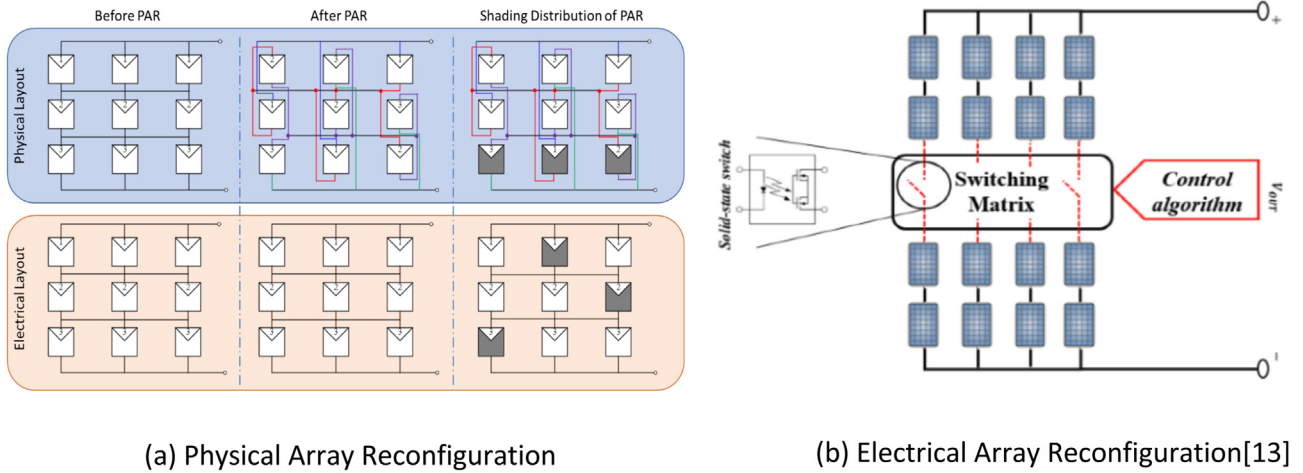

Fig. 5. PV array reconfiguration techniques.

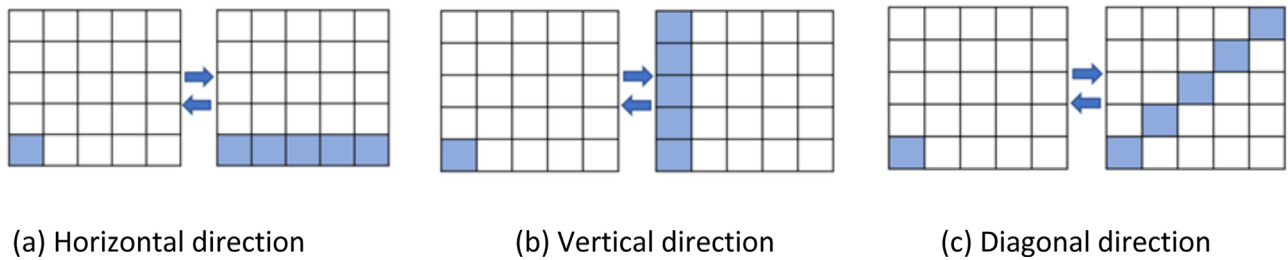

Fig. 6. Simplified D-PSCs.

PSC by changing the shadow distribution on the PV array. They are usually developed based on traditional PV configurations. The most used basic configuration is the TCT connection, which is considered in this paper.

– Physical Array Reconfiguration (PAR) is also seen as a static reconfiguration method. The PAR relocates the PV modules' physical position without altering the PV array's electrical connection. The main idea of PAR is to distribute the shadings into different rows to balance the row current. Figure 5a gives an example of the distribution of horizontal shadings before and after the PAR. Typical PAR includes Sudoku (SDK), Zig-Zag, Magic Matrix, etc. [7].

– Comparatively, Electrical Array Reconfiguration (EAR) technique is a dynamic reconfiguration strategy. EAR modifies the electrical contacts among PV modules directly through a switching matrix, shown in Figure 5b [13]. The EAR method needs a great number of sensors and switches. Hence, its cost is higher compared to PAR.

3 Simulation

3.1 Dynamic shading cases

The size of the PV array under study is 5×5 . The dynamic shading cases are simplified into three main types based on varying directions: horizontal, vertical, and diagonal. In a

dynamic shading case, the shape of the shadow changes with time, along one direction. The shadow could extend or shorten on the PV array, as depicted in Figure 6.

3.2 Factors affecting the PV array performance

The indicator considered to analyze the performance of PV configurations is Daily Energy Loss $DEL(\%)$, defined in equation (13).

$$DEL(\%) = \frac{E_{GPP,U} - E_{GPP,PS}}{E_{GPP,U}} \times 100, \quad (13)$$

$$E_{GPP,U} = \sum_{t=1}^{24} P_{GPP,U}(t), \quad (14)$$

$$E_{GPP,PS} = \sum_{t=1}^{24} P_{GPP,PS}(t), \quad (15)$$

where, $E_{GPP,U}$, $E_{GPP,PS}$ are the generated daily energy under uniform irradiance and PSCs, respectively. $P_{GPP,U}$, $P_{GPP,PS}$ are the Global Maximum Power of PV array under uniform irradiance and PSCs, respectively.

3.3 Irradiance data

The irradiance data is from the open-access database of PVGIS [21]. PVGIS is an online PV parameter tool offered

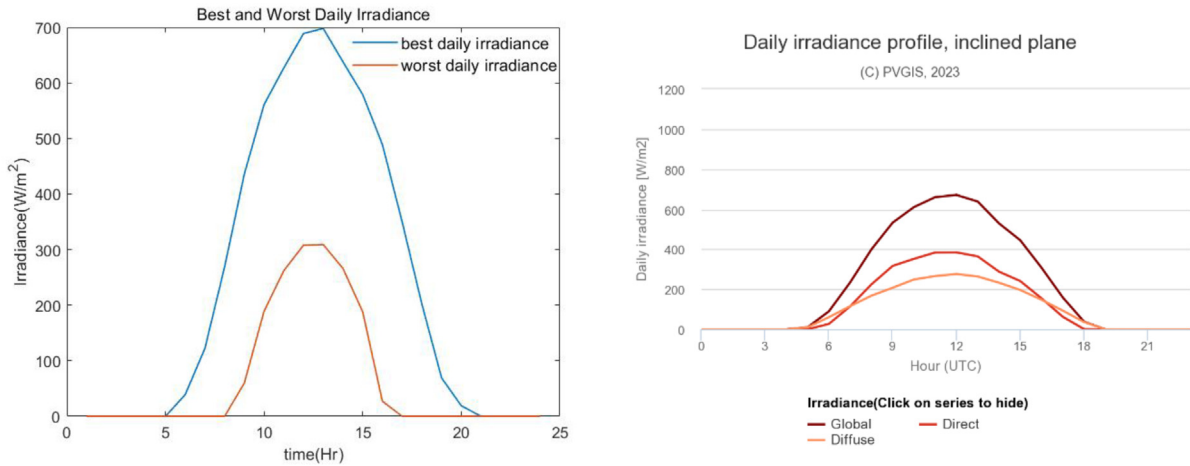

(a) Daily irradiance curves in August and January from PVGIS

(b) The composition of the irradiance

Fig. 7. Irradiance information from PVGIS.

by Europe Commission. In this article, the selected location for the PV system is in Palaiseau, France (48.72°N, 2.25°E). The curves of the best (August) and worst (January) daily global irradiance (Tilted irradiance, the slope of the PV panel is 35°, the azimuth angle of the panel is 0°) are displayed in Figure 7a. In this work, the best daily irradiance is considered.

Figure 7b gives the composition of the daily irradiance. The global irradiance is the sum of the direct and diffuse irradiances. In this paper, the global irradiance is applied on the PV array as the uniform irradiation condition. When PS occurs, only the diffuse irradiance is considered.

4 Results and discussion

As mentioned in Sections 2 and 3, the main objective is to compare the performance of different PV reconfiguring methods under D-PSCs. The applied PV layouts are four traditional PV configurations, SuDoKu (SDK) represented PAR, and an irradiance-uniformization-based EAR. The main idea of the irradiance-uniformization-based EAR is to distribute the shadings to different rows. The adopted EAR is sorting the irradiance in descending order with digits 1–25, according to numbers 1–25, to fill in the PV array vertically following the Z alignment, then using the switching matrix to realize the rearranged PV layout.

Suppose that there is a shadow shortening from 11:00 to 12:00. The daily power curves of the three dynamic shading cases are presented in Figures 8–10.

4.1 Horizontal D-PSC

The detailed performance is shown in Figure 8. It is obvious that EAR and SDK have similar behavior under Horizontal D-PSC, and is much better than the four traditional PV configurations. Among the traditional configurations, SP is relatively better than the others.

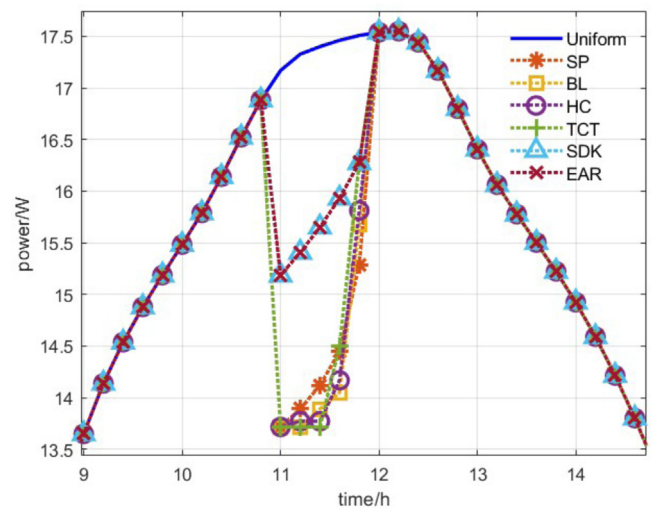

Fig. 8. Daily power curves under horizontal D-PSC.

4.2 Vertical D-PSC

The detailed performance is shown in Figure 9. It is found that TCT, EAR, SDK have similar behavior under CASE2, and are better than the other three traditional PV configurations (SP, BL and HC).

4.3 Diagonal D-PSC

The detailed performance is shown in Figure 10. SDK exhibits lower performance in Diagonal D-PSC compared to Horizontal D-PSC and Vertical D-PSC: it is usually the worst PV layout. EAR and TCT give the best outputs during the shading time. HC connection sometimes has high power losses, like SDK. SP and BL do not offer the best output power, but their performance is more stable, compared to HC.

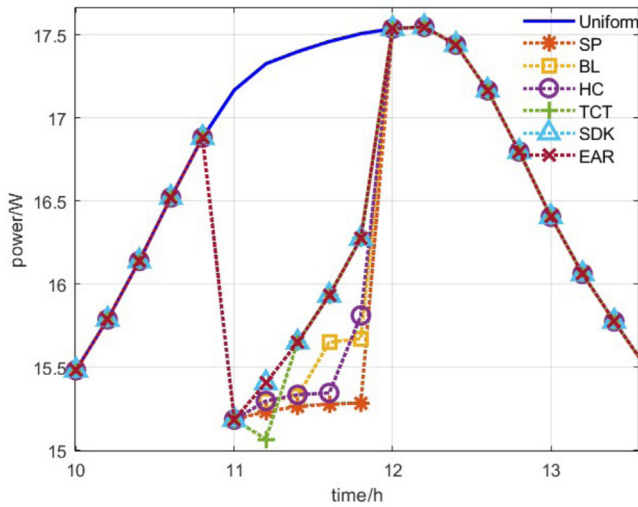

Fig. 9. Daily power curves under vertical D-PSC.

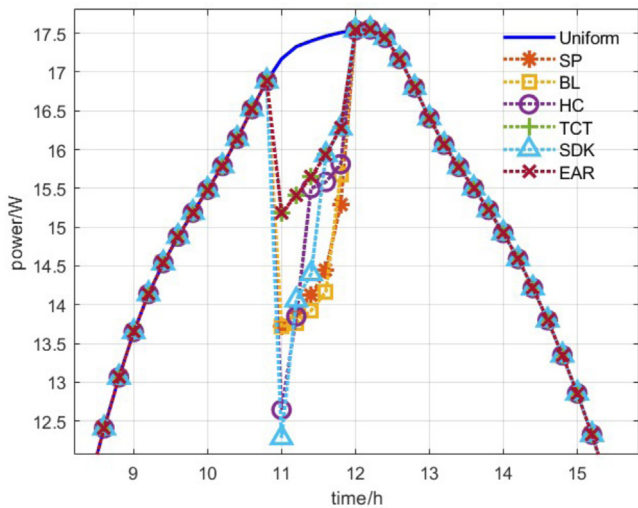

Fig. 10. Daily power curve under diagonal D-PSC.

The simulation results are presented in Table 3. The comparison of the different reconfiguration techniques is depicted in Figure 11. It could be concluded that BL and HC connections have the worst performance. The SP and EAR are robust to all PSCs. EAR has the smallest daily energy losses. Besides, TCT and SDK are second best choices, but their performance is less stable as expected. The diagonal D-PSC is responsible for the highest energy losses compared to the other two cases with SDK connection. For TCT layout, it is the horizontal case that has the worst impact.

5 Conclusion

The simulation results show great differences on the performance of various PV array reconfiguration techniques. It could be seen that for different dynamic cases, the

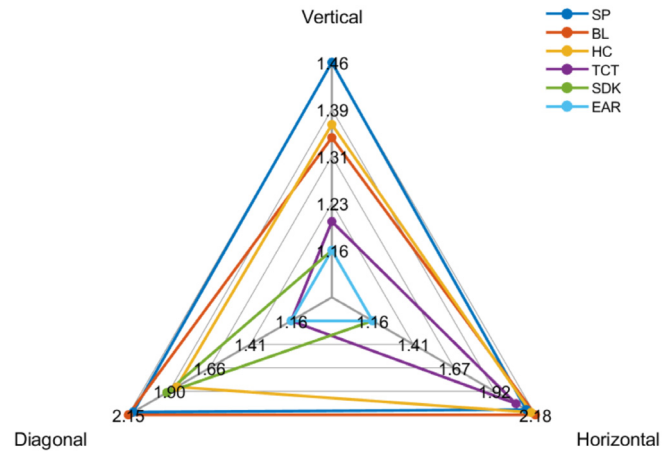

Fig. 11. The Rida Figure of daily energy losses under D-PSCs.

Table 3. The DEL in % under the three D-PSCs cases.

	SP	BL	HC	TCT	SDK	EAR
Horizontal D-PSC	2.12	2.18	2.15	2.06	1.16	1.16
Vertical D-PSC	1.46	1.34	1.36	1.21	1.16	1.16
Diagonal D-PSC	2.12	2.15	1.86	1.16	1.92	1.16

strategies can be adjusted. EAR is always the best choice if the power efficiency is the only factor under consideration. The performance of SDK (PAR) is the second best, nevertheless, it doesn't work so well under Diagonal D-PSC. Among the four traditional configurations, TCT is the first choice. In fact, SDK could help to improve the efficiency of the PV array under most of the D-PSCs cases. Considering economic and efficiency factors, the PAR could be better than EAR.

Even if this work is based on simplified D-PSCs cases, it could be used as a reference thanks to the results showing that the performance is different for the typical PV layouts. In future works, the approach developed in this study could be applied to the BIPV systems. The effects of real D-PSCs on buildings and the performance of the different reconfiguration techniques will be evaluated.

The authors thank the Chinese Scholarship Council for providing the scholarship.

Author contribution statement

Conceptualization, Chuanyong SHAO, Anne MIGAN-DUBOIS; methodology, Chuanyong SHAO, Anne MIGAN-DUBOIS; formal analysis, Chuanyong SHAO, Anne MIGAN-DUBOIS, Demba DIALLO; investigation, Chuanyong SHAO, Anne MIGAN-DUBOIS; writing—original draft preparation, Chuanyong SHAO, Anne MIGAN-DUBOIS, Demba DIALLO; supervision, Anne

MIGAN-DUBOIS, Demba DIALLO; writing—review and editing, Chuanyong SHAO, Anne MIGAN-DUBOIS, Demba DIALLO; All authors have read and agreed to the published version of the manuscript.

References

1. R. Lucija, P. Leen, Solution Booklet-BIPV (Online Report) (2021). <https://smart-cities-marketplace.ec.europa.eu/insights/solutions/solution-booklet-building-integrated-pv>
2. D.J. Sailor, J. Anand, R.R. King, Photovoltaics in the built environment: a critical review, *Energy Build* **253**, 111479 (2021)
3. B. Kristijan, B. Matevž, T. Marko, Annual energy losses due to partial shading in PV modules with cut wafer-based Si solar cells, *Renew. Energy* **168**, 195 (2021)
4. S.R. Pendem, S. Mikkili, Ace assessment of PV array topologies under partial shading conditions to mitigate the mismatching power losses, *Sol. Energy* **160**, 303 (2018)
5. A.A. Desai, S. Mikkili, Modeling and analysis of PV configurations to extract maximum power under partial shading conditions, *CSEE J. Power Energy Syst.* **8**, 1670 (2022)
6. F. Belhachat, C. Larbes, Modeling, analysis and comparison of solar photovoltaic array configurations under partial shading conditions, *Sol. Energy* **120**, 399 (2015)
7. D. Sharma, M.F. Jalil, M.S. Ansari, R.C. Bansal, A review of PV array reconfiguration techniques for maximum power extraction under partial shading conditions, *Optik* **275**, 170559 (2023)
8. O. Bingöl, B. Özkaya, Analysis and comparison of different PV array configurations under partial shading conditions, *Sol. Energy* **160**, 336 (2018)
9. A.M. Ajmal, T. Sudhakar Babu, V.K. Ramachandramurthy et al., Static and dynamic reconfiguration approaches for mitigation of partial shading influence in photovoltaic arrays, *Sustain. Energy Technol. Assess.* **40**, 100738 (2020)
10. I.N. Alkallak, Using magic square of order 3 to solve Sudoku grid problem, *Tikrit J. Pure Sci.* **26**, 358 (2013)
11. S.G. Krishna, T. Moger, Optimal SuDoKu reconfiguration technique for total-cross-tied PV array to increase power output under non-uniform irradiance, *IEEE Trans. Energy Convers.* **34**, 1973 (2019)
12. S. Vijayalekshmy, G.R. Bindu, S. Rama Iyer, A novel Zig-Zag scheme for power enhancement of partially shaded solar arrays, *Sol. Energy* **135**, 92 (2016)
13. K. Osmani, A. Haddad, H. Jaber et al., Mitigating the effects of partial shading on PV system's performance through PV array reconfiguration: a review, *Therm. Sci. Eng. Progr.* **31**, 101280 (2022)
14. A.A. Desai, S. Mikkili, Modeling and analysis of PV configurations to extract maximum power under partial shading conditions, *CSEE J. Power Energy Syst.* **8**, 1670 (2020)
15. P.K. Bonthagorla, S. Mikkili, Performance investigation of hybrid and conventional PV array configurations for grid-connected/standalone PV systems, *CSEE J. Power Energy Syst.* **8**, 682 (2020)
16. G. Sai Krishna, T. Moger, Enhanced power generation for total-cross-tied PV array using simulated annealing under partial shading conditions, *IET Renew. Power Generat.* **14**, 3457 (2020)
17. G. Sai Krishna, T. Moger, Improved SuDoKu reconfiguration technique for total-cross-tied PV array to enhance maximum power under partial shading conditions, *Renew. Sustain. Energy Rev.* **109**, 333 (2019)
18. G. Sai Krishna, T. Moger, Reconfiguration strategies for reducing partial shading effects in photovoltaic arrays: state of the art, *Sol. Energy* **182**, 429 (2019)
19. M. Premkumar, U. Subramaniam, T.S. Babu et al., Evaluation of mathematical model to characterize the performance of conventional and hybrid PV array topologies under static and dynamic shading patterns, *Energies* **13**, 3216 (2020)
20. F. Belhachat, C. Larbes, PV array reconfiguration techniques for maximum power optimization under partial shading conditions: a review, *Sol. Energy* **230**, 558 (2021)
21. PVGIS Online Tool, https://joint-research-centre.ec.europa.eu/pvgis-online-tool_en (accessed 3 March 2023)

Citation de l'article : Chuanyong Shao, Anne Migan-Dubois, Demba Diallo, Performance of PV array configurations under dynamic partial shadings, *EPJ Photovoltaics* **14**, 21 (2023)