



**HAL**  
open science

# Nonlinear optics: from theory to applications, with a focus on the use of two-photon absorption in biology

Melanie Dreano, Olivier Mongin, Frédéric Paul, Mark G. Humphrey

## ► To cite this version:

Melanie Dreano, Olivier Mongin, Frédéric Paul, Mark G. Humphrey. Nonlinear optics: from theory to applications, with a focus on the use of two-photon absorption in biology. *Australian Journal of Chemistry*, 2023, 76 (3), pp.130-149. 10.1071/CH23015 . hal-04149352

**HAL Id: hal-04149352**

**<https://hal.science/hal-04149352>**

Submitted on 4 Jul 2023

**HAL** is a multi-disciplinary open access archive for the deposit and dissemination of scientific research documents, whether they are published or not. The documents may come from teaching and research institutions in France or abroad, or from public or private research centers.

L'archive ouverte pluridisciplinaire **HAL**, est destinée au dépôt et à la diffusion de documents scientifiques de niveau recherche, publiés ou non, émanant des établissements d'enseignement et de recherche français ou étrangers, des laboratoires publics ou privés.

# Nonlinear optics: from theory to applications, with a focus on the use of two-photon absorption in biology

Mélanie Dréano<sup>A,B</sup>, Olivier Mongin<sup>B</sup>, Frédéric Paul<sup>B,\*</sup> and Mark G. Humphrey<sup>A,\*</sup>

<sup>A</sup>*Research School of Chemistry, Australian National University, Canberra, ACT 2601, Australia.*

<sup>B</sup>*Univ. Rennes, CNRS, ISCR (Institut des Sciences Chimiques de Rennes) - UMR 6226, F-35000 Rennes Cedex, France.*

## ABSTRACT

The study of nonlinear optics in the 1960s attracted considerable attention from a theoretical standpoint, engendering many proposals for practical use of these new photonic effects. Among these suggestions, the development of efficient two-photon absorption (2PA) has attracted sustained interest due to its demonstrated (or potential) use in a broad range of applications that include optical data storage, optical limiting and nanofabrication. The use of 2PAs in biological applications is particularly appealing. This is because 2PA offers several advantages for bio-oriented applications, such as intrinsic three-dimensional resolution, increased penetration depth in biological materials such as tissue and highly focused excitation at half-energy, leading to a decrease of auto-fluorescence and photodamage. In this Primer Review, we introduce the essential background theory needed for an understanding of the field, we describe the key experiments deployed to quantify material performance, we discuss the evolution of 2PA molecular design, and we summarise the state-of-the-art and the existing challenges in the use of 2PAs in imaging, therapy and theranostics.

**Keywords:** *cubic hyperpolarisabilities, dipolar molecules, nonlinear absorption, nonlinear optics, octupolar molecules, quadrupolar molecules, two-photon excitation photodynamic therapy, two-photon fluorescence microscopy.*

## Introduction to nonlinear optics: second- and third-order effects

Light is a key requirement for life on earth, including photosynthesis by plants that produces the oxygen that we breathe. Light also gives us information about the world we live in as it interacts with matter in various ways, such as refraction, diffraction, absorption, reflection and scattering. Optics is the field of physics that studies these interactions of light (radiation) with matter (molecules or atoms). Usually, these interactions do not depend on the intensity of the light beam; this is a field of study called linear optics. In nature, the intensities of light waves are weak, and when light waves propagate through a medium, matter does not interact with multiple photons. To formalise this, we use the description of light as an electromagnetic wave, consisting of an oscillating electric field  $\mathbf{E}$  along with the corresponding oscillating magnetic field  $\mathbf{B}$ . When a light source interacts with a dielectric material composed of molecules (e.g. a host-guest solid or a solution), the applied electric field  $\mathbf{E}$  can displace the electronic charges within the molecules and give rise to a change in the molecular dipole moment  $\boldsymbol{\mu}$ . In linear optics,  $\boldsymbol{\mu}$  evolves linearly with the field's magnitude  $\mathbf{E}$  (Eqn 1):

$$\boldsymbol{\mu}(\omega) = \boldsymbol{\mu}_0 + \boldsymbol{\alpha}(\omega)\mathbf{E}(\omega) \quad (1)$$

where  $\boldsymbol{\mu}_0$  is the static dipole moment within the molecule and  $\boldsymbol{\alpha}$  is the linear polarisability at frequency  $\omega$ .

However, when the light beam is more intense, the parameters from linear optics become a function of the light intensity; the induced dipole moment  $\boldsymbol{\mu}$  of the molecule evolves into a nonlinear function of the field strength  $\mathbf{E}$ . This nonlinearity at the microscopic level can be approximated by expansion as a Taylor series (Eqn 2):

$$\boldsymbol{\mu}(\omega) = \boldsymbol{\mu}_0 + \boldsymbol{\alpha}\mathbf{E}(\omega) + \boldsymbol{\beta}\mathbf{E}(\omega)^2 + \boldsymbol{\gamma}\mathbf{E}(\omega)^3 + \dots \quad (2)$$

where  $\boldsymbol{\beta}$  is the quadratic (second-order) hyperpolarisability and  $\boldsymbol{\gamma}$  is the cubic (third-order) hyperpolarisability.

Nonlinear optical (NLO) phenomena occur when a very intense light beam interacts with non-conducting matter composed of molecules/atoms, leading to a nonlinear effect of the medium on the optical properties of the transmitted beam (frequency, amplitude, phase, polarisation, etc.). The ability of nonlinear media to modulate the optical signature of an electromagnetic field has provided dielectric materials with a multitude of applications, e.g. uses in optical fibres, optical data storage, microfabrication, optical power limiting and medicine.[1] The main topic of this Primer Review, 2PA, is a third-order NLO effect that was proposed in 1931,[2] but its experimental confirmation, like all other NLO effects,[3] had to await the development of lasers in the early 1960s.

Another way to account for the light field-induced electric dipole moment variation is the polarisation density  $\mathbf{P}$ , which is the dipole moment per unit volume. The expansion of  $\mathbf{P}$  governs NLO phenomena in bulk materials at a macroscopic level (Eqn 3):

$$\mathbf{P}(\omega) = \mathbf{P}_0 + \chi^{(1)}\mathbf{E}(\omega) + \chi^{(2)}\mathbf{E}(\omega)^2 + \chi^{(3)}\mathbf{E}(\omega)^3 + \dots \quad (3)$$

where  $\mathbf{P}_0$  is the permanent linear polarisation within the material,  $\chi^{(1)}$  is the linear susceptibility,  $\chi^{(2)}$  is the quadratic susceptibility and  $\chi^{(3)}$  is the cubic susceptibility.

The electric field of an electromagnetic wave can be expressed as a time–frequency dependence (Eqn 4):

$$\mathbf{E}(\omega, t) = E_0 \cos(\omega t) \quad (4)$$

where  $\omega$  is the optical frequency and  $t$  is elapsed time. Using this expression, the previous Eqns 2, 3 can be extended and describe various non-linear phenomena. We will discuss some of them, starting with second-order nonlinear effects, and will then look at third-order nonlinear effects, followed by presenting an in-depth look at 2PA.

**Second-order nonlinear optical processes:** Second- order (or quadratic) processes result principally from the ‘squared’ terms in Eqns 2, 3. In these phenomena, the induced polarisation  $\mathbf{P}$  is proportional to the square of the local electric field, and the materials are defined by their quadratic susceptibility tensor  $\chi^{(2)}$ . It is important to note that second- order effects can only occur in non-centrosymmetric media.

If we develop Eqn 3 by expressing the electric field with the time–frequency dependence in Eqn 4, and if we consider that the incident beam is composed of two waves with different frequencies but the same amplitudes ( $E_0$ ), we obtain:

$$\mathbf{P}(\omega_1, \omega_2) = \mathbf{P}_0 + \chi^{(1)}E_0\omega_1 t + \chi^{(1)}E_0\omega_2 t + \chi^{(2)}E_0^2 \cos(\omega_1 t) \cos(\omega_2 t) \quad (5)$$

Eqn 5 describes the main origin of second-order nonlinear effects. We will briefly touch on some of these in the following: second-harmonic generation (SHG), sum-frequency generation (SFG), difference-frequency generation (DFG), optical parametric oscillation (OPO), optical parametric amplification (OPA) and the Pockels effect.

SHG, also called frequency doubling, is a particular sum- frequency phenomenon where the two incident waves have the same frequency  $\omega_1 = \omega_2 = \omega$  and the same amplitudes ( $E_0$ ). Consequently, after the introduction of a trigonometric identity, Eqn 5 can be expressed as:

$$\mathbf{P}(\omega) = \mathbf{P}_0 + \chi^{(1)}E_0\omega t + \chi^{(2)}E_0^2 \frac{1}{2} (1 + \cos(2\omega t)) \quad (6)$$

Eqn 6 shows the appearance of a second-harmonic wave, with a doubling of the frequency. The interaction with matter of the two incident waves with identical frequency  $\omega$  creates a polarisation through the second-order susceptibility, forming a third wave having twice their frequency ( $2\omega$ ) (Fig. 1). SHG was the first nonlinear process observed;[3] its range of applications extends from microscopy to surface characterisation[4] and spectroscopy techniques.[5] Its main use is in the second-harmonic microscopy of bio-entities; this will be briefly discussed at the end of this section on 2nd order NLO processes. SFG and DFG are two other ‘frequency-combining’ effects. In sum-frequency generation, two

incident waves with different frequencies  $\omega_1$  and  $\omega_2$  interact to form a third beam  $\omega_3$  with frequency equal to the sum of the two incident frequencies, *i.e.*  $\omega_3 = \omega_1 + \omega_2$ . In difference-frequency generation, the emitted wave  $\omega_1$  is the result of subtraction:  $\omega_1 = \omega_3 - \omega_2$  (Fig. 2). Note that the actual observation of a sum or difference beam depends on the relative intensities of the incoming beams and of the phase relationships between them, so this is highly dependent on the relative orientations of the incoming and resulting beams (to achieve phase matching of the various beams).[6] These effects have found applications in areas such as optical radar, spectroscopy, microscopy and optical clockwork.

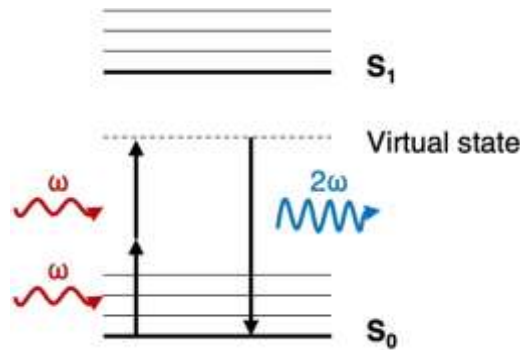


Fig. 1. Second-harmonic generation (SHG).

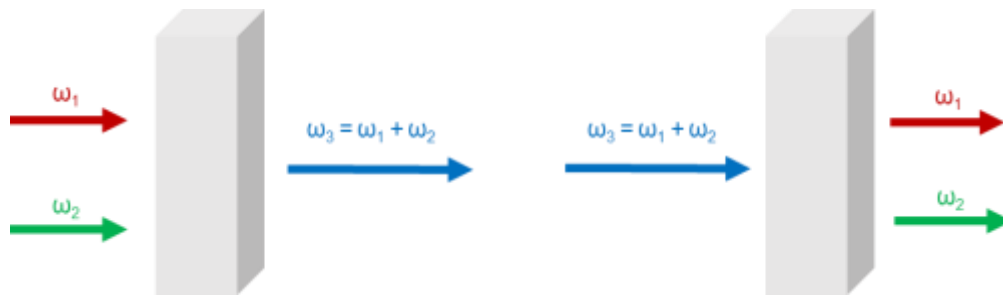
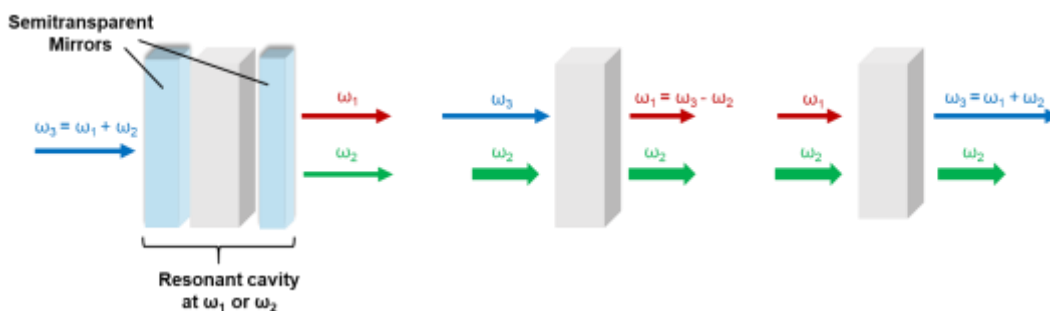


Fig. 2. Sum-frequency generation (SFG) (left) and difference-frequency generation (DFG) (right).

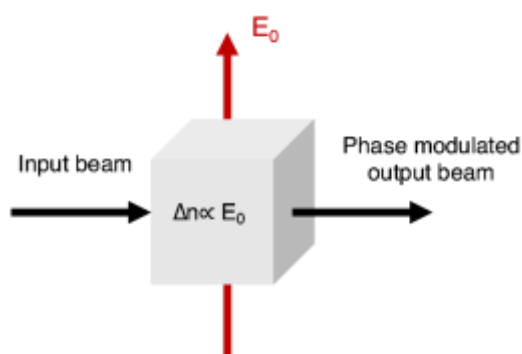
Three important frequency-combination phenomena that occur through the second-order nonlinear component are optical parametric oscillation (OPO), optical parametric amplification (OPA) and parametric upconversion (PU) (Fig. 3). OPO consists of the splitting of one incident wave into two transmitted waves with the use of a specific optical resonator (which will determine the resulting frequencies) that includes an NLO-active medium such as a crystal. In the case of OPA, two incident waves  $\omega_2$  and  $\omega_3$  interact with non-linear materials to generate an amplified signal of one of the incident frequencies, in this example  $\omega_2$ . This phenomenon can happen by dividing  $\omega_3$  into two waves,  $\omega_1$  and  $\omega_2$ , where  $\omega_1 = \omega_3 - \omega_2$ . Finally, PU allows one to increase the frequency of a given beam by a known quantity ( $\omega_2$  in Fig. 3). PU is often used to convert an IR beam into a periodic signal at higher energy in the visible

or UV range.[6] OPA and OPO are mainly employed to generate tunable lasers that find use in imaging, spectroscopy, and quantum lithography.[1,6]



**Fig. 3.** Schematic (simplified) representations of applied uses of frequency mixing based on second-order nonlinear optics: Optical parametric oscillation (OPO) (left), optical parametric amplification (OPA) (middle), and parametric upconversion (PU) (right).

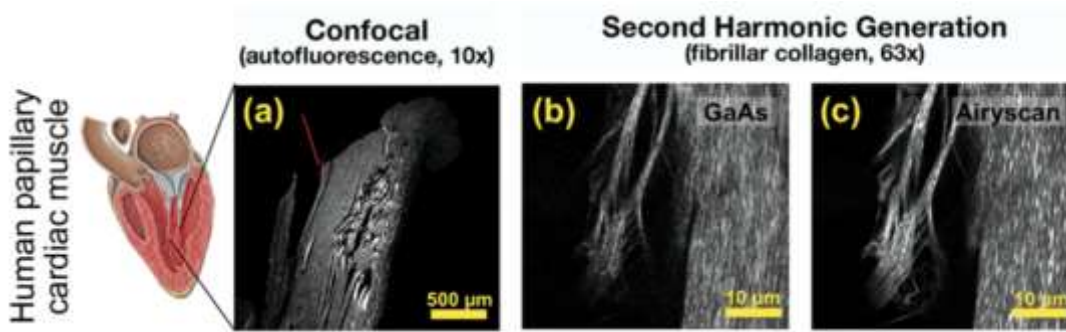
The Pockels effect, also known as the linear electro-optic effect, is another second-order nonlinear phenomenon. In this case, an external electric field is applied through the medium, leading to a change of the refractive index; the transmitted beam is consequently out of phase (Fig. 4). The change in the refractive index is a linear function of the external static electric field, but the induced polarisation of the material leading to the phase shift is related to  $\chi^{(2)}$ , and so the Pockels effect is indeed a second-order nonlinear phenomenon. The linear electro-optic effect finds use in various electro-optic applications[7] (e.g. optical switching). To the best of our knowledge, host-guest optimised molecular materials have not yet replaced inorganic solid crystals in commercial electro-optic modulators, in spite of far better figures of merit.



**Fig. 4.** Pockels effect.

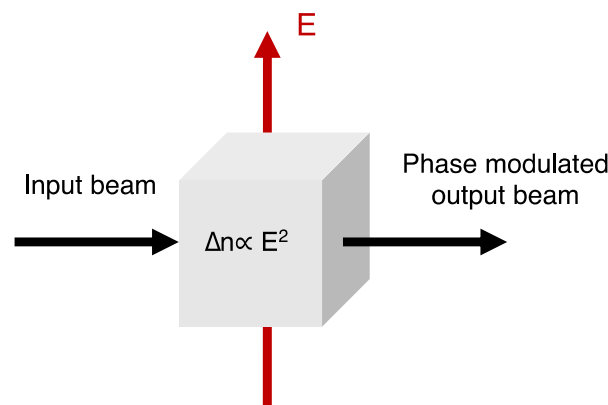
From an applied point of view, SHG using molecules has been most widely used in NLO contrast imaging of collagen, membranes, myosin, microtubules, etc. The use of laser wavelengths in the near infrared spectroscopic region leads to deeper tissue penetration[8] (Fig. 5) and, because SHG does not

require excitation of molecules, but arises from an induced polarisation, it results in significantly reduced phototoxicity and photobleaching compared to fluorescence microscopies.



**Fig. 5.** Images of human papillary cardiac muscle. Comparison between confocal autofluorescence microscopy (a) and SHG microscopy using two different detectors (b-c). © 2020 Barlow et al.[8]

**Third-order nonlinear optical processes:** Third-order nonlinear effects exhibit a cubic dependence on the strength of the electric field  $E$  (Eqn 3). In this case, and unlike second-order NLO effects, we are not limited to non-centrosymmetric compounds or materials; every molecule can give rise to third-order effects, regardless of its symmetry. Third-order effects are characterised by their susceptibility tensor  $\chi^{(3)}$ , which is a complex number comprising a real part and an imaginary part  $\chi^{(3)} = \chi^{(3)}_{re} + i \times \chi^{(3)}_{im}$ , the former responsible for refractive effects and the latter responsible for absorptive phenomena. We will describe some third-order NLO effects in the following: the Kerr effect and third-harmonic generation (THG) are induced by a refractive modification of the medium, while saturable absorption (SA), reverse saturable absorption (RSA) and 2PA arise from the absorption of two photons. A more in-depth treatment of 2PA will be given because it is the NLO phenomenon which has afforded the most important applied uses so far.



**Fig. 6.** Electro-optic Kerr effect.

The Kerr effect was discovered in 1865 and, as with the Pockels effect, this phenomenon results in a change of the refractive index of the medium when an external electric field is applied[9] (Fig. 6). However,

in contrast to the Pockels effect, where the induced change of the refractive index is a linear function of the electric field, a quadratic dependence is observed with the Kerr effect; in other words, the refractive index change is proportional to the square of the external electric field intensity. Two types of Kerr effect can be distinguished: the electro-optic Kerr effect and the optical Kerr effect. In the electro-optic Kerr effect, the modification of the refractive index is induced by an external electric field, while in the optical Kerr effect, the electric field of the incident light is behind the change. The Z-scan experiment relies on the latter effect, where a change of refractive index induced by light results in self-focusing or self-defocusing of the incident beam. As a third-order NLO effect, the Kerr effect can be observed in both non-centrosymmetric and centrosymmetric media, unlike the Pockels effect. The Kerr effect is often used in optical fibres to gate the light beam.

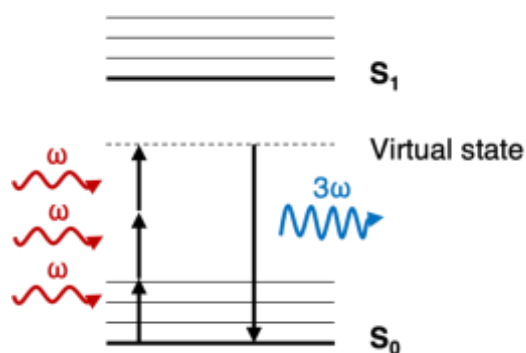


Fig. 7. Third-harmonic generation (THG).

THG, or frequency tripling, is also a third-order nonlinear effect, and it follows the same principle as SHG. THG corresponds to the sum of three input beams of frequency  $\omega$ , leading to a fourth wave of triple the frequency,  $3\omega$  (Fig. 7). This phenomenon is rare, due to the challenging phase-matching requirements needed to collect a beam at the third harmonic after transmission through a nonlinear dielectric material. In practice, frequency tripling is often realised by SHG (Fig. 1) followed by a sum-frequency process (Fig. 2), or in other words successive second-order NLO effects. THG has applications in microscopy and spectroscopy.[6]

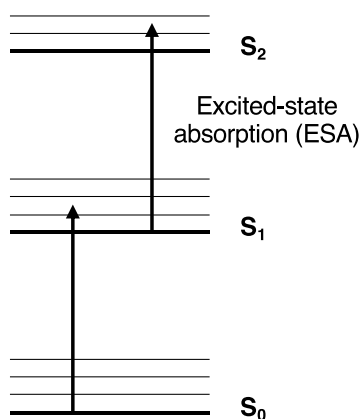
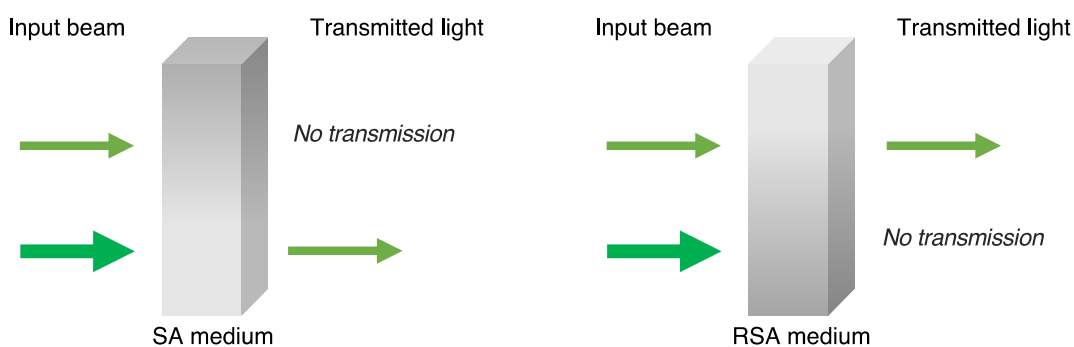


Fig. 8. Excited-state absorption (ESA).



The nonlinear absorption phenomena described in this section all involve the absorption of two photons by the medium. It is important to note that there are different ways for a molecule to absorb two photons. First, in the case of SA and RSA, the two photons are absorbed in distinct steps. The ground state of the molecule absorbs a photon to reach the first excited state of the molecule, and then that excited state absorbs a second photon via excited-state absorption (ESA), leading to a second excited state (Fig. 8). The first (intermediate) excited state exhibits different photophysical properties to the ground state, resulting in phenomena such as SA and RSA for the ‘global’ cumulative absorption process.

If the second excited state has a lower absorptivity than the ground state, the transmittance of the medium will increase with the light intensity. This phenomenon, corresponding to SA, can induce a process called photoinduced transparency and is widely used in laser cavities for passive Q-switching and mode-locking. The opposite process occurs in RSA, for which the absorption cross-section of the excited state is greater than that of the ground state: this results in a decrease of the transmittance as the photon density increases.[1] The medium becomes less transparent, and a process named photodarkening is observed (Fig. 9). RSA is widely used in optical limiting devices.[10]



**Fig. 9.** Saturable absorption (SA) and reverse saturable absorption (RSA). The thickness of the arrows represents the intensity of the light beam.

A molecule can also absorb two photons simultaneously to reach an excited state, without passing through an intermediate excited state. For convenience, the intermediate state is then assumed to be ‘virtual’, meaning that it has negligible lifetime. This nearly instantaneous process is called 2PA, and it will be discussed in the following section.

## Two-photon absorption: theory and measurement

When a molecule is irradiated with a light source, it can potentially absorb a photon and undergo a transition from a lower energy level to a higher energy level. The molecule can then relax to the ground state by a non-radiative process or by re-emitting a photon, in which case luminescence can be observed.

However, if the intensity of the light source is high enough, the molecule can absorb two photons of half-energy simultaneously and reach the same excited state (Fig. 10). This phenomenon, called 2PA, is far less common than those described above.

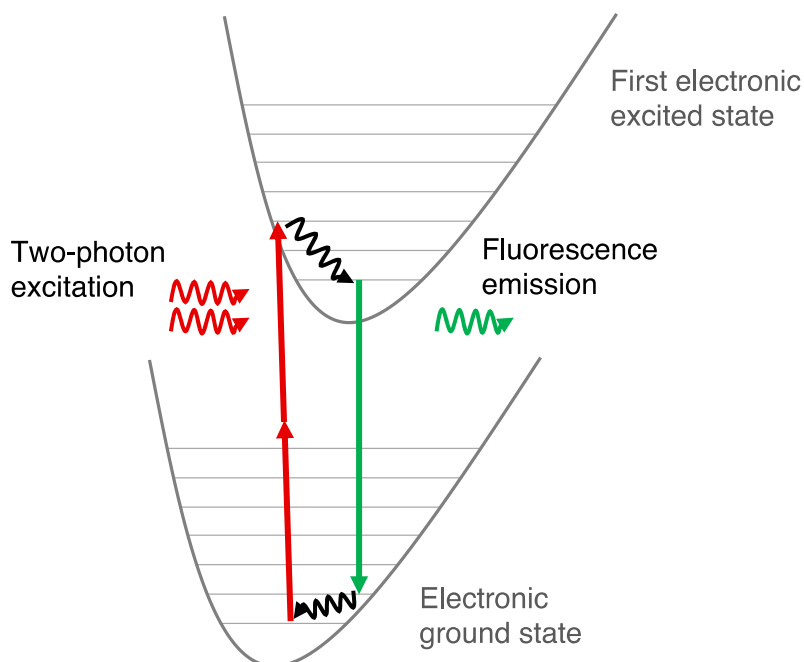


Fig. 10. Two-photon absorption (2PA).

Degenerate and non-degenerate 2PA can be differentiated, depending on whether the two photons absorbed simultaneously have the same or different energy (Fig. 11). In practical work, the use of a monochromatic light source is more common and useful, and from now on, we will only consider 2PA corresponding to the degenerate process.

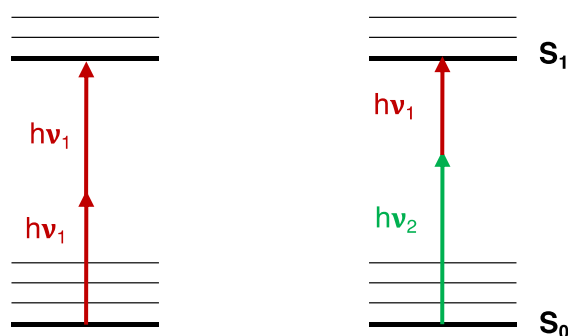


Fig. 11. Degenerate (left) and nondegenerate (right) 2PA.

As discussed above, the cubic susceptibility term  $\chi^{(3)}$  characterises third-order NLO processes at the macroscopic level and is complex, the real part being linked to the nonlinear changes of the refractive index, as well as THG, while the imaginary part is related to the 2PA properties of a given material. The 2PA cross section  $\sigma_2$  can be expressed as a function of the imaginary part of  $\chi^{(3)}$  through Eqn 7. The 2PA

cross-section describes the quantitative sensitivity of a two-photon molecular event; it is usually quoted in Göppert–Mayer (GM) units, with 1 GM corresponding to  $10^{-50} \text{ cm}^4 \text{ s photon}^{-1}$ :

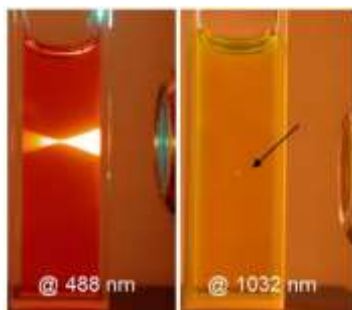
$$\sigma_2 = \frac{8\pi^2 h \omega^2}{n^2 c^2 N} \chi \quad (7)$$

where  $n$  is the refractive index,  $c$  is the speed of light in a vacuum,  $\omega$  is the angular frequency of photons,  $N$  is the molecular density (in units of molecules/cm<sup>3</sup>), and  $h$  is Planck's constant.

While one-photon absorption (1PA) is linearly proportional to the light beam intensity  $I$ , 2PA is proportional to the square of that intensity. This relationship results in 2PA having a strong dependence on the distance  $Z$  to the laser focal point on the beam propagation axis (see Eqn 8, where the square of the intensity ( $I^2$ ) is inversely proportional to the quartic power of  $Z$  and  $Z \gg z_R$ , where  $z_R$  is the Rayleigh length):[11]

$$2PA \propto E^2 \propto Z^{-4} \quad (8)$$

This process therefore leads to highly localised excitation of the molecules in a sample that are within the focal volume of the laser beam (Fig. 12), inducing remarkable spatial resolution, in contrast to 1PA. In addition, the energy of the photons necessary to effect the electronic transition in 2PA is half that required for 1PA, which allows the use of lasers with longer wavelengths, and thereby better penetration in tissue and reduced photodamage.



**Fig. 12.** Images of one-photon absorption at 488 nm (left) and two-photon absorption at 1032 nm (right).

To quantify 2PA processes, two experimental techniques are important: two-photon excited fluorescence (TPEF) and Z-scan. The former enables determination of the 2PA cross-section of fluorescent compounds by measuring the emission after excitation with an intense laser beam. With non-radiative compounds, it is better to opt for the Z-scan technique as this gives access to the real and imaginary parts of the third-order hyperpolarisability; however, this technique usually results in decreased accuracy because 2PA in Z-scan can be convoluted with SA or RSA. It is worth noting that when comparing the 2PA cross-sections of a family of molecules, the same experimental set-up should be used for optimum rigour. The principles of these two techniques will now be presented.

TPEF spectroscopy gives access to the 2PA cross-section  $\sigma_2$  of luminescent compounds by measurement of the 2PA brightness, which corresponds to the product of  $\sigma_2$  and the fluorescence quantum yield  $\Phi_F$ , the latter usually measured separately with a fluorimeter. In this technique, a femtosecond pulsed laser beam excites molecules in solution and the resulting emission passes through a dichroic filter and is collected by a detector (Fig. 13). The dichroic filter blocks the incident wavelength light, so that only the photons from the emission are detected. TPEF is a quick and accurate method to determine  $\sigma_2$ , making it the technique of choice for measuring 2PA of fluorescent compounds. However, it usually does not give access to other third-order NLO contributions (refractive phenomena, SA, RSA), and is not suitable for the study of non-emissive samples.

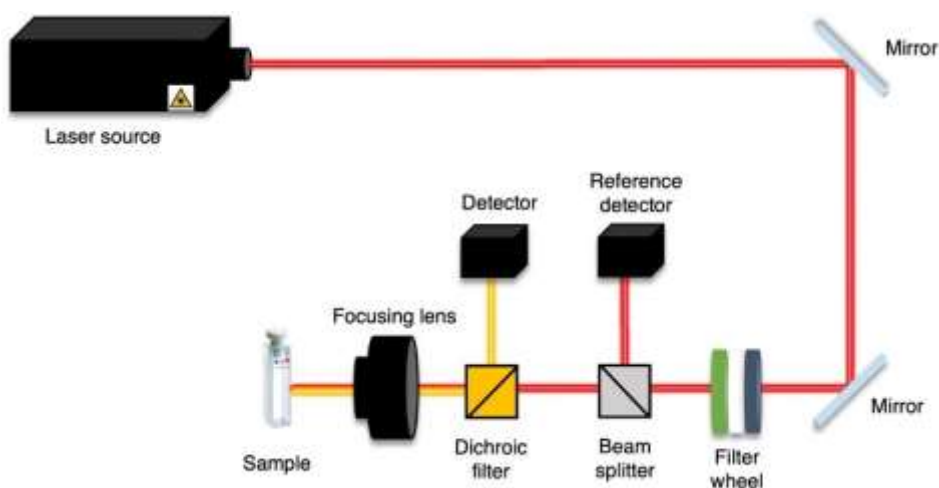
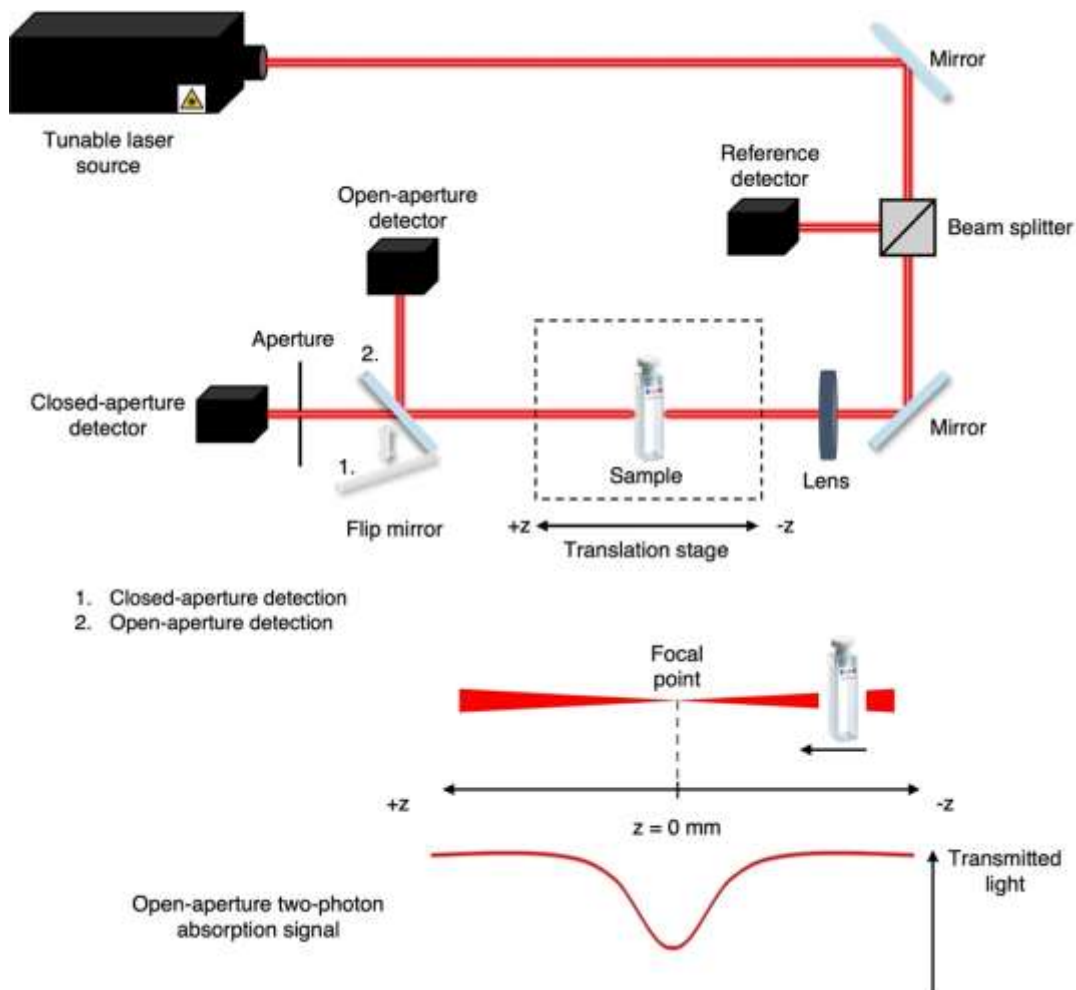


Fig. 13. TPEF set-up.

The Z-scan technique is the second method of choice for measuring 2PA cross-sections. Unlike TPEF, it permits characterisation of non-emissive compounds and provides information on other third-order NLO processes, such as refractive processes linked to  $\chi^{(3)}_{re}$ . Indeed, Z-scan gives access to both the real part and the imaginary part of the cubic hyperpolarisability, so refractive and absorptive phenomena can both be studied. A pulsed laser beam is focused to a focal point ( $z = 0$ ), and as the sample moves along the  $z$ -axis, two detectors collect the transmitted light (the closed-aperture and the open-aperture detectors: Fig. 14 (top)). The closed-aperture detector measures the transmitted light resulting from a change in the refractive index of the sample, i.e. the refractive phenomenon, and defines the real part of  $\chi^{(3)}$ . The open-aperture detector measures the change of light intensity, i.e. the absorptive phenomenon, and determines the imaginary part of  $\chi^{(3)}$ . Any absorptive behaviour shows a specific spectral signature; with 2PA, the transmitted light decreases when the sample is at the focal point, leading to a minimum in the transmittance curve at  $z = 0$  (Fig. 14 (bottom)).



**Fig. 14.** Z-scan set-up (top) and a typical 2PA data profile from an open-aperture measurement (bottom).

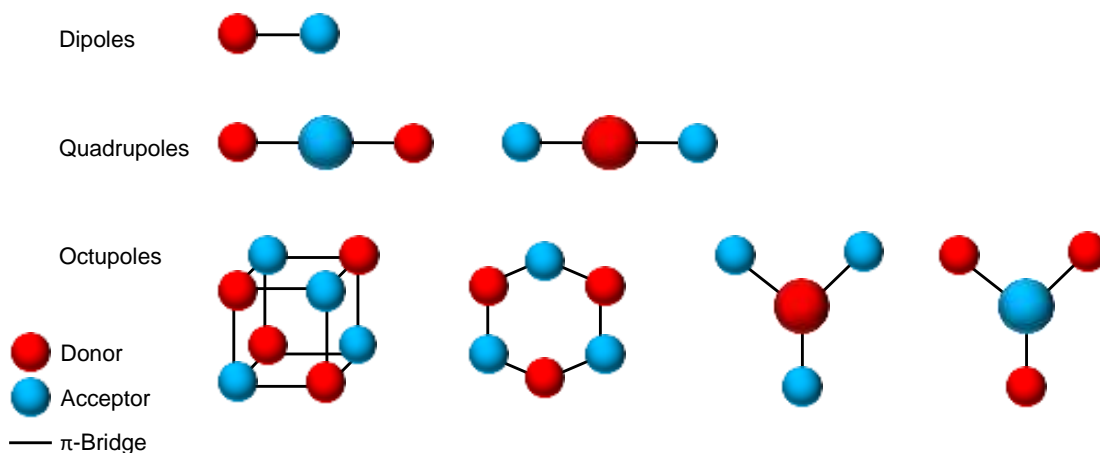
From a practical perspective, because 2PA cross-sections are wavelength-dependent (in a similar fashion to 1PA: for example, a typical UV-vis spectrum), a wavelength-tunable laser system is needed to ensure that the maximal values of the 2PA cross-section are captured in the Z-scan experiment. Furthermore, because there are several NLO effects that can result in the overall absorption of two photons, and our interest here is in the *instantaneous* 2PA rather than the (slower) stepwise 2PA of 1PA followed by ESA, a low- repetition rate ultrafast-pulsed laser system is needed. This means that to establish a Z-scan experiment useful for the assessment of new 2PA molecules, one needs a laser system outputting short light pulses ( $\sim 100$  femtoseconds is typical) at a low repetition rate (typically 1 kHz or slower) and that is wavelength-tunable from the near UV through the visible and into the near infrared region ( $\sim 400\text{--}2000$  nm would correspond to a typical spectral range capability, but access to a broader range is desirable). The cost of establishing such a capacity (factoring in the additional need for a large optical bench, detectors, spectrometer, a translation stage, lenses, mirrors, mounts, cells, etc.) can approach AUD \$1M (2022). Noting the ongoing need for routine access to expert technical support to maintain the system, it is clearly expensive to set up and maintain such a capacity, so the interested

synthetic chemist should explore entry into this exciting area via collaboration with an established laser laboratory.

## Two-photon absorption: molecular design

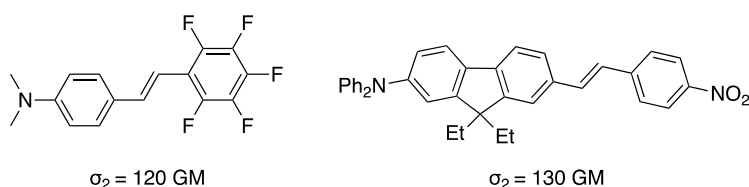
Experimental 2PA with an organic dye was first reported in 1963.[12] Several groups measured the 2PA performance of organic and inorganic molecules in the following years, but very small cross-sections were observed (around 1 GM). For most molecules, the probability of simultaneously absorbing two photons is very low, so molecular design by chemists is needed to achieve sufficiently large responses for applications. To aid 2PA molecular design, the establishment of structure–NLO property relationships has received considerable attention in the past few years from chemists all over the world. Thanks to their synthetic versatility, fast responses, straightforward preparation, easy incorporation in thin films or polymers and biological compatibility, organic/organometallic molecules appear to be preferable to inorganic salts as 2PA materials. According to essential state models derived from sum-over-states expressions,[1] strongly allowed excited state(s) at low energy and involving significant charge separation (i.e. resulting in a large dipole moment change compared to the ground state) are central for enhancing the 2PA cross-section. In this respect, intramolecular charge transfer (ICT) within the  $\pi$ -manifold of a given molecule is often the driving force for 2PA, so chromophores with electron-donating and/or -withdrawing groups linked by an extended  $\pi$ -system possess a promising molecular architecture for 2PA. The  $\pi$ -system facilitates charge separation and ICT is enhanced by enforcing coplanarity; the electronic coupling is more efficient through a planar structure than through a twisted conformation, and so coplanarity of the constituents of the compounds is also a key criterion in the design of chromophores with large  $\sigma^2$  values. Multipolar charge distributions and overall symmetry appear to be important criteria that should be considered in the pursuit of improved 2PA. Furthermore, it has been shown that the insertion of transition metal atoms can further enhance the non-linear properties of a molecule.[13] The following section describes some interesting architectures of literature 2PA dyes and is followed by a discussion of how organometallics have a role to play in this field.

With ICT as a driving force, the simultaneous presence of donor and/or acceptor groups is a necessity for achieving efficient 2PA. The design strategies to link these components led to the classification of three key families of chromophores: dipolar,[14] quadrupolar[15] and octupolar[16] (Fig. 15); for the last-mentioned, it was shown that if the magnitude and signs of electronic/excitonic coupling are favourable, cooperative enhancement between the chromophore branches can occur. We will now discuss these three types of architectures.



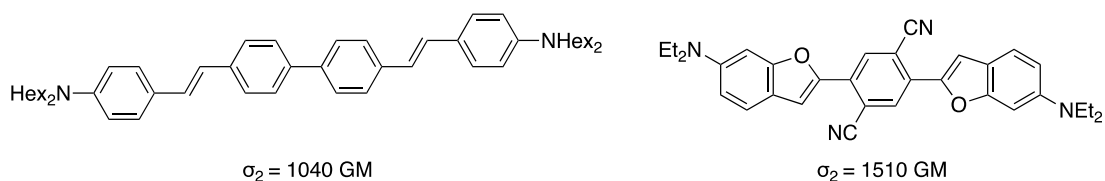
**Fig. 15.** Dipolar, quadrupolar and octupolar structures.

The simplest dipolar one-dimensional architectures consist of one electron-releasing group and one electron-accepting group on either side of a  $\pi$ -conjugated system D- $\pi$ -A (Fig. 16).[17,18] This dissymmetric ‘push-pull’ structure allows an intramolecular charge transfer (ICT) between the two entities during excitation and relaxation. In addition to 2PA, these structures always exhibit second-order NLO properties.



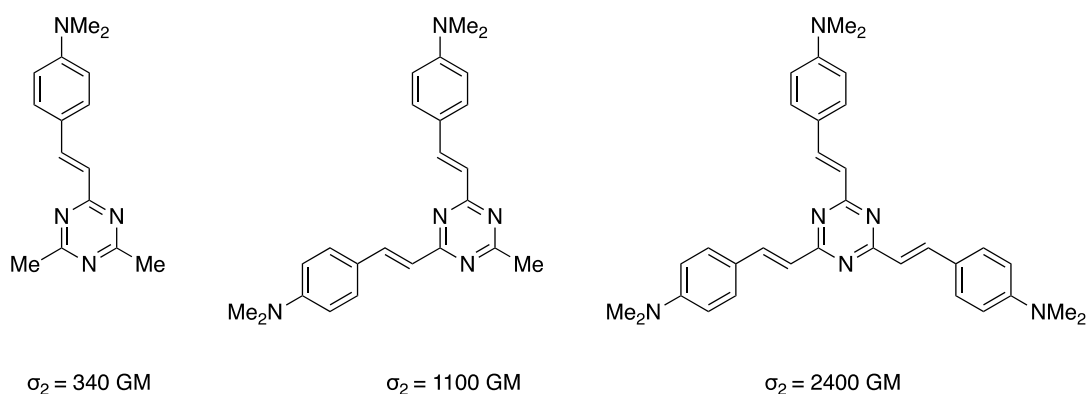
**Fig. 16.** D- $\pi$ -A dipolar molecules. Cross-sections measured by fs TPEF in toluene (left)<sup>[17]</sup> and in THF (right).<sup>[18]</sup>

Simple quadrupoles possess two donors or acceptors connected by a  $\pi$ -bridge (D- $\pi$ -D or A- $\pi$ -A), and are thus ‘push-push’ or ‘pull-pull’ in composition. Due to their centrosymmetry and their specific selection rules for electronic transitions, quadrupolar 2PA chromophores can have greater cross-sections than dipolar analogues.[11] The overall molecular polarisability can be improved by the insertion of other donor or acceptor moieties within the conjugated chain (*e.g.* D- $\pi$ -A- $\pi$ -D or A- $\pi$ -D- $\pi$ -A),[1] leading to stronger intramolecular charge transfer and thus a greater cross-section (Fig. 17).[19,20] It has been shown that quadrupoles with donor units as terminal groups (*i.e.* D- $\pi$ -D and D- $\pi$ -A- $\pi$ -D) tend to exhibit larger 2PA than their A- $\pi$ -A and A- $\pi$ -D- $\pi$ -A analogues.[19] Due to their centrosymmetric nature, quadrupolar structures exhibit no second-order NLO properties.



**Fig. 17.** D- $\pi$ -D (left)<sup>[19]</sup> and D- $\pi$ -A- $\pi$ -D (right)<sup>[20]</sup> quadrupolar molecules. Cross-sections measured by fs TPEF in toluene.

Octupolar structures are often three-dimensional non-centrosymmetric molecules which have no permanent dipole moment, but they can also be two-dimensional tri-branched chromophores consisting of a central electron-accepting (-donating) group connected to three electron-donating (-accepting) moieties (D3(A-core) or A3(D-core)).<sup>[21]</sup> In such structures, the increased number of conjugation paths between A and D usually leads to larger  $\sigma_2$  values.<sup>[16]</sup> Moreover, if the electronic or vibronic coupling between the branches is strong, a cooperative effect can be observed, a special case where the cross-section of the tri-branched chromophore is larger than three times that of the individual arm. After early single-wavelength observations by Z-scan,<sup>[22]</sup> this was subsequently confirmed on many examples by TPEF (Fig. 18).<sup>[23]</sup> This concept has also been applied to dendritic structures.<sup>[24]</sup> Apart from the cooperative enhancement, octupoles offer several other advantages compared to their dipolar or quadrupolar counterparts. The branches can help prevent aggregation between the cores, and consequently favour efficient emission. The multi-branched structure can also transfer the energy as fluorescence resonance energy transfer (FRET) from the branches to the core (via an 'antenna' effect) and thereby increase the efficiency of the core emission.<sup>[25]</sup> The second-order NLO properties of octupolar structures result from the sum of global octupolar and arm-localised dipolar contributions, making octupolar dyes often more attractive than dipolar ones.<sup>[21]</sup> As is the case with second-order NLO properties, octupolar compounds can exhibit enhanced 2PA properties compared to their dipolar components.<sup>[26]</sup>



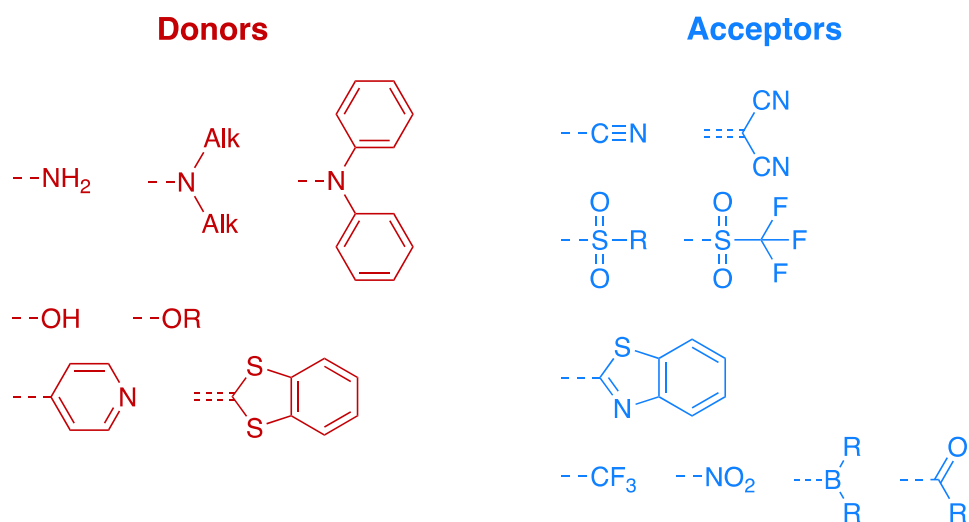
**Fig. 18.** A cooperative NLO effect in an octupolar molecule. Cross-sections measured by fs TPEF in THF.<sup>[23]</sup>

Due to their larger two-photon cross-sections, quadrupoles and octupoles are usually the structures of choice when 2PA is sought. Many studies have been devoted to fine-tuning the electronic coupling between molecular components in order to significantly improve the 2PA efficiency.

With ICT as a driving force, the necessity to optimise the donor and acceptor groups is obvious. A straightforward way to enhance the 2PA cross-section is, indeed, to increase the strength of the electron-donating and -accepting substituents of the chromophore. The most widely used donors and acceptors have been summarised elsewhere (Fig. 19).<sup>[1]</sup> Dialkyl and diaryl amino groups are usually more effective

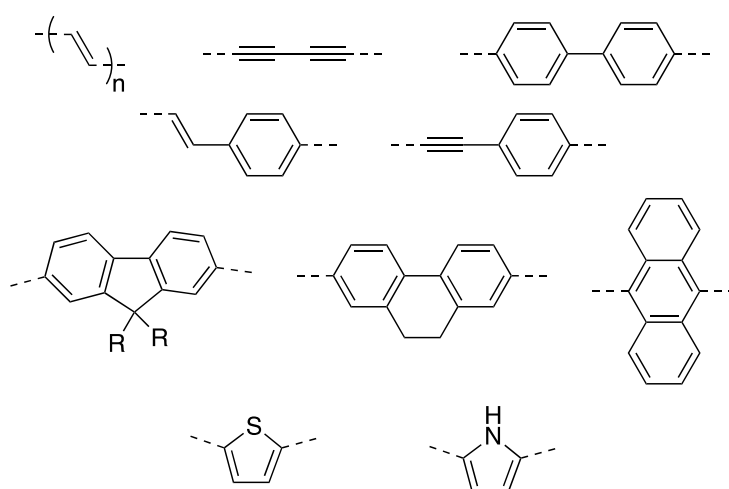


donors than oxygen-based analogues, and are consequently used more often. Pyridine and benzodithiole groups offer the advantage of enhancing the ICT through a rigid and planar structure. Note that pyridine can also behave as a weak acceptor. The two most commonly used acceptors are the cyano and sulfoxide groups. As pointed out previously,[19] structures with terminal donors appear more efficient, and consequently the electron-accepting moieties are often incorporated at the conjugated bridge (see below) or at the central core, rather than being used as terminal groups.



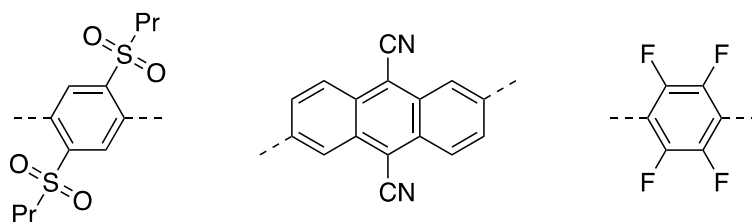
**Fig. 19.** Classical donor and acceptor groups used in two-photon chromophores.[1]

The type and length of the conjugated  $\pi$ -system are important criteria to consider when designing two-photon dyes (Fig. 20). ICT is improved when  $\pi$ -orbital overlap is favoured,[1,11] i.e. when the molecule adopts a rigid and planar conformation. The central bridge plays an important role in maximising electronic coupling; for example, fluorene, dihydrophenanthrene and anthracene-based compounds usually show greater 2PA cross-sections than 4,4'-biphenyl units, thanks to their planarity and rigidity.[1]



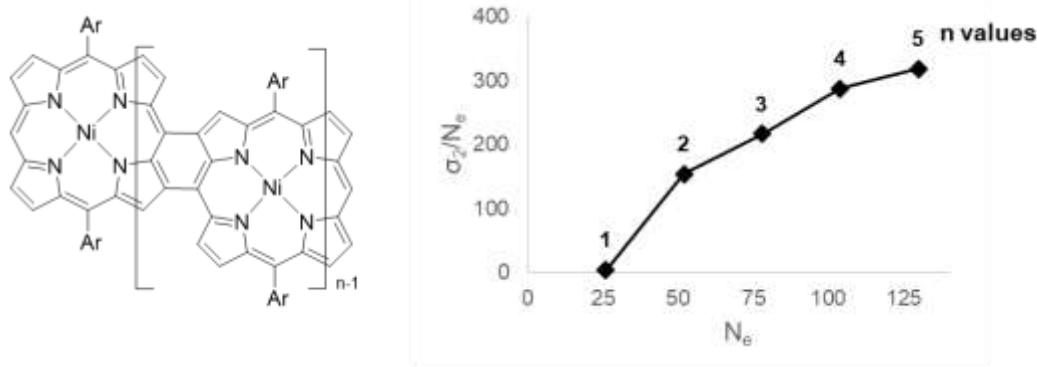
**Fig. 20.** Commonly used conjugated bridges.[1]

When designing quadrupolar structures, one can choose to enhance the  $\sigma_2$  value by increasing the accepting or donating ability of the central core. Some examples of possible modifications are illustrated below (Fig. 21).[11]



**Fig. 21.** Acceptor-containing  $\pi$ -bridges.[11]

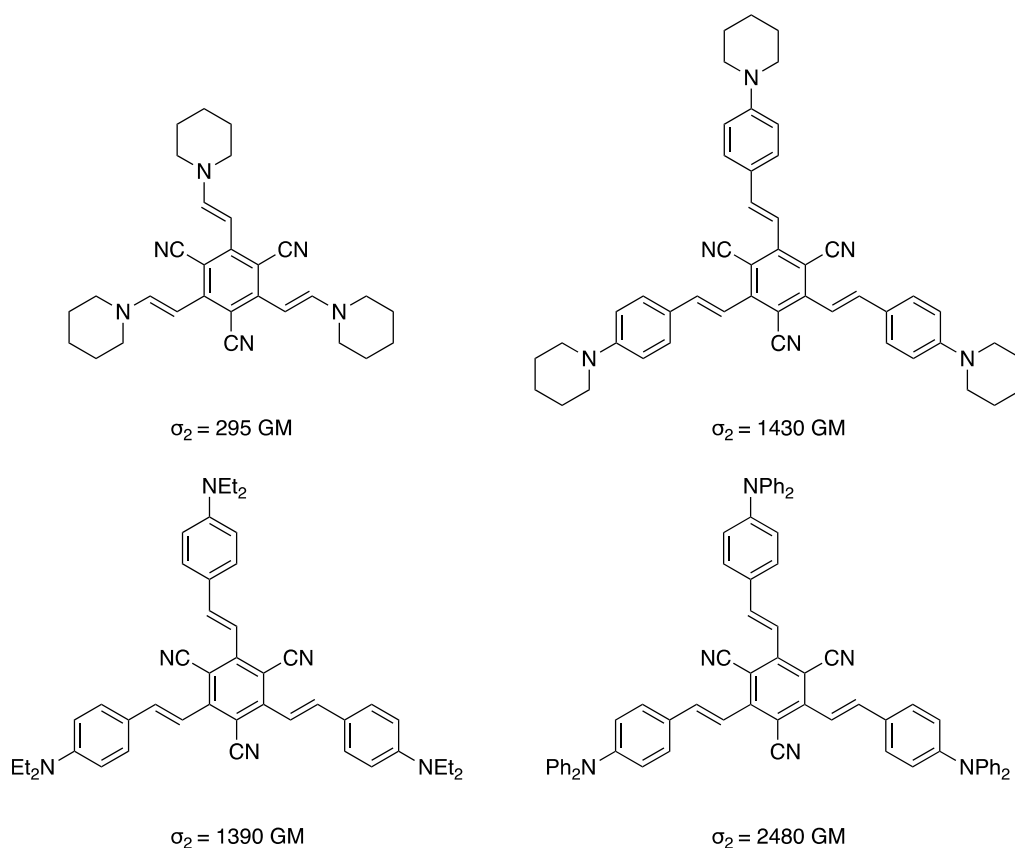
Increasing the length of the  $\pi$ -system by the  $n$ -fold repetition of a bridge unit can lead to drastic changes in the 2PA cross-section.[27] One way to explore the relationship between the length of the  $\pi$ -system and  $\sigma_2$  is to examine the effect on the latter of increasing the number of ‘effective’  $\pi$  electrons ( $N_e$ ),[27] an illustration being given in Fig. 22 (obtained from independent data published previously[28]),[11,13] although, as Kuzyk has explained,[27] a rigorously correct scaling would involve examination of  $\sigma_2/(N_e)^2$  instead of  $\sigma_2/N_e$ . Extension of the  $\pi$ -system significantly enhances the  $\sigma_2/N_e$  ratio proceeding from the monomer to the dimer. While this ratio increases with further increase in the number of fused porphyrins, the increase is not so marked, and indeed the curve reaches a plateau and saturates. Every chromophore is different, reaching its saturation point at different  $\pi$ -system lengths; this is an important criterion to consider when optimising molecular design.



**Fig. 22.** Normalised 2PA cross-sections for fused porphyrin oligomers ( $n = 1-5$ ).<sup>[11]</sup> Copyright © 2009 WILEY-VCH Verlag GmbH & Co. KGaA, Weinheim.

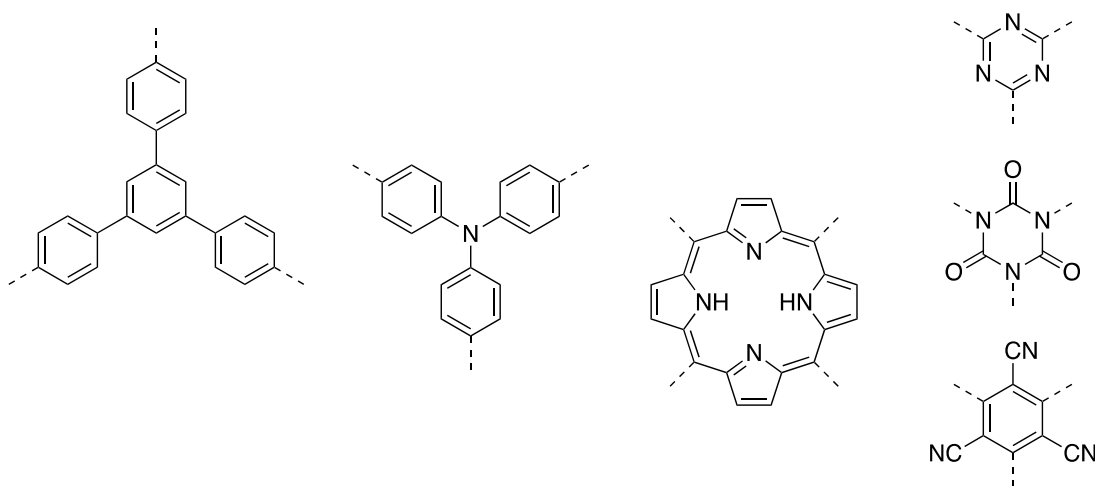
The central core of multi-branched compounds can play the role of an acceptor or donor group, depending on the electronic properties of the peripheral substituents. The core ideally allows strong electronic coupling between the branches, giving rise to a cooperative enhancement in NLO properties. This strong electronic coupling can thereby lead to higher  $\sigma_2$  values than would be expected based on simple additivity, as shown previously for selected triazines (Fig. 18).[23] Octupolar structures with tricyanobenzene electron-withdrawing cores also exhibit substantial 2PA cross-sections (Fig. 23), further

demonstrating that C3-symmetric molecular geometries are promising 2PA dyes; [26] increasing the donor strength and the conjugation length leads to higher  $\sigma_2$  values.



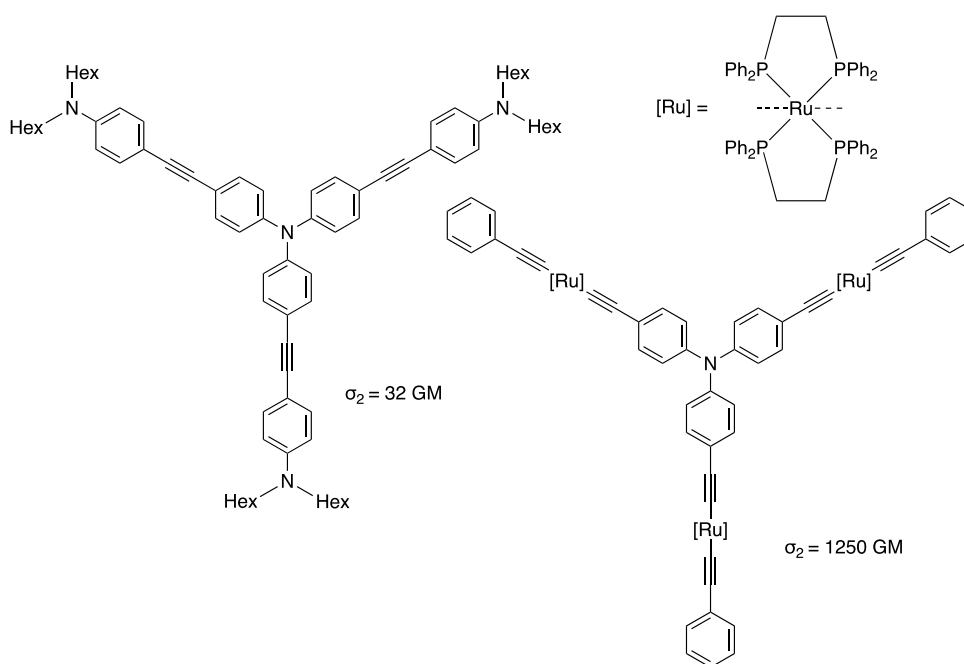
**Fig. 23.** Octupolar molecules.[26]

Other efficient cores for 2PA multi-branched dyes include triphenylbenzene, triphenylamine, porphyrin and isocyanurate (Fig. 24).[13]



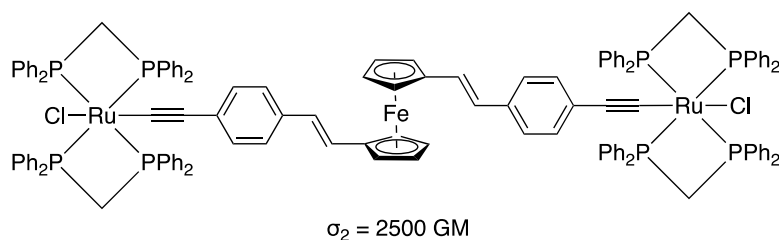
**Fig. 24.** Cores of tri- and tetra-branched structures.[13]

While organic molecules have received most attention in the search for efficient two-photon absorbers, organometallic complexes have also attracted interest. Organometallics can offer advantages compared to inorganics and organics, and lead to more diverse structures. The insertion of transition metal atoms into an organic framework tends to enhance the NLO properties of the molecule due to the increased number of polarisable electrons.[13] In such structures, MLCT or LMCT excited states play the role of the ICT states in purely organic two-photon absorbers (see above). Ferrocenyl and metal alkynyl complexes are the most popular moieties when it comes to the design of third-order NLO organometallics. Metal-based systems can also feature several accessible oxidation states that can be used to ‘switch’ the molecular nonlinearity,[29] while organometallic complexes have been shown to exhibit NLO responses significantly greater than organic analogues (Fig. 25).[30]



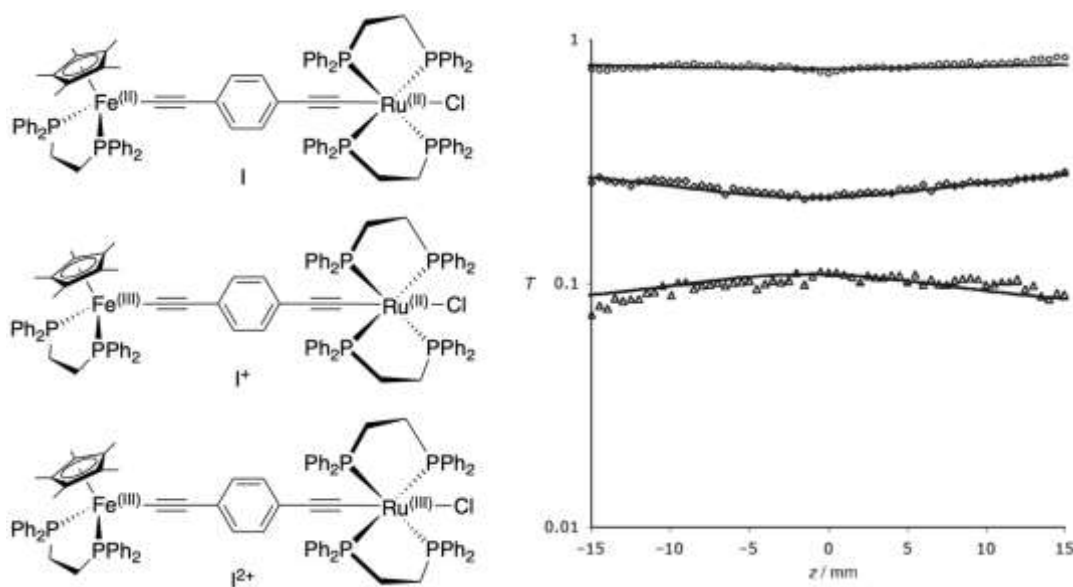
**Fig. 25.** Comparison of analogous organic and organometallic compounds. 2PA cross-sections measured by fs TPEF (left)<sup>[28]</sup> and fs Z-scan (right).<sup>[30]</sup>

Another approach to increase the NLO response involves the combination of several metal centres via a  $\pi$ -system (e.g. the highly NLO-efficient heterometallic complex in Fig. 26, with one ruthenium(II) on either side of a ferrocene unit).[31]



**Fig. 26.** Heterometallic complex with large 2PA cross-section measured by fs Z-scan.<sup>[31]</sup>

Furthermore, group-8 transition metals are often redox-active. In this respect, electrochemical switching between different oxidation states of a molecule can modulate the NLO response because this can change or reverse the polarisation of the starting molecule. For example, the mixed iron–ruthenium Fe<sup>II</sup>/Ru<sup>II</sup> dipolar complex **I** (Fig. 27) possesses two reversible metal couples, Fe<sup>II/III</sup> and Ru<sup>II/III</sup>, and by varying the potential of the applied electric field (−0.6, 0, +0.8 V), the system can be oxidised or reduced, affording three different states **I**, **I**<sup>+</sup> and **I**<sup>2+</sup>. Z-scan studies indicate that while **I** (circles) does not exhibit any nonlinear absorption, **I**<sup>+</sup> (diamonds) is a two-photon absorber, and **I**<sup>2+</sup> (triangles) is a saturable absorber. This system is therefore a nonlinear absorption ‘switch’ (between 2PA and SA) at 790 nm.[32]



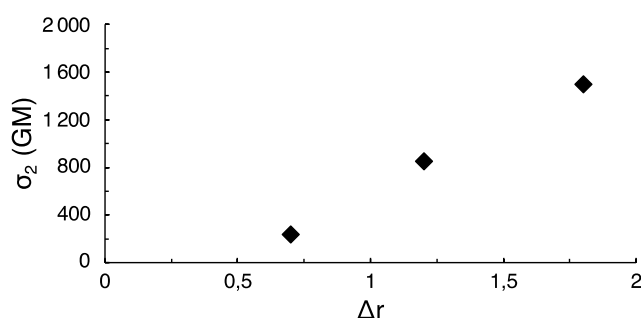
**Fig. 27.** Electrochemical switching of the NLO response of an iron-ruthenium complex. Open-aperture scans at 790 nm at −0.6 V (circles, **I**), 0.0 V (diamonds, **I**<sup>+</sup>) and +0.8 V (triangles, **I**<sup>2+</sup>). Reused with permission. Copyright © 2006 Wiley-VCH Verlag GmbH & Co. KGaA, Weinheim.[32]

As presented above, transition metal atoms often enhance the NLO response of molecules. However, many complexes are non-emissive, with relaxation from triplet excited states to the ground state often being non-radiative, and therefore restricting applications. In this regard, phosphorescent platinum[33] and iridium[34] complexes have proven useful in instances where 2PA-excited luminescence is important.

The factors influencing the 2PA ability of a molecule are varied and complicated. Because  $\sigma_2$  is related to the imaginary part of the cubic susceptibility, its theoretical prediction is often very difficult. The relationship between molecular structure and the third-order NLO properties is part of a complex wave function and is consequently difficult to calculate accurately for large molecules (>50 atoms), so new 2PA dyes have tended to be experimentally discovered without prior theoretical screening. There is therefore a strong need to develop simple, fast-screening, and intuitive methods to evaluate the  $\sigma_2$  of organic and organometallic chromophores and guide the design of new and more efficient two-photon absorbers. Several two-photon diagnostic tools have emerged for small organic molecules in the last decade, paving

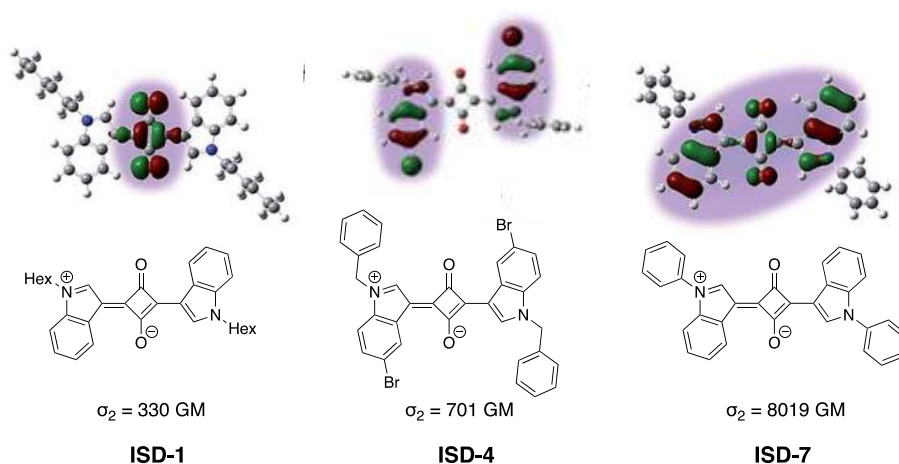
the way for the development of simple and straightforward approaches for screening larger organic systems without the need for DFT computations.

A computational tool has been developed examining the effect of  $\Delta r$  (a measure of the average hole–electron distance upon excitation) on the 2PA cross-section of dipolar structures. While the plot obtained shows an almost linear dependence between  $\Delta r$  and  $\sigma_2$  (Fig. 28), this ‘diagnostic tool’ lacks broad applicability, being only accurate for dipolar non-centrosymmetric molecules.[35] As discussed above, such an approach reinforces the need for strongly polarised dipolar structures in the pursuit of strong 2PA responses.



**Fig. 28.** Plot of the relationship between  $\Delta r$  and  $\sigma_2$ . Used with permission of Royal Society of Chemistry (RSC), from *Chem. Commun.* **1996**, 50; permission conveyed through Copyright Clearance Center, Inc.<sup>[35]</sup>

A high degree of electron delocalisation of the final excited state is also correlated to high  $\sigma_2$  values, so analysis of natural transition orbitals (NTOs) can shed light on the 2PA merit of small centrosymmetric chromophores. Using this approach, indolic squaraine dyes (ISD) with  $\sigma_2$  values up to  $\sim 8000$  GM were designed (Fig. 29).[36]



**Fig. 29.** Calculated "holes" of the final excited state of various ISDs and their respective 2PA cross-sections measured by fs TPEF. Reproduced from Ref.<sup>[36]</sup> with permission from the Royal Society of Chemistry.

The lifetime of the ICT charge-separated excited state can be used as an experimental indicator of  $\sigma_2$  for small dipolar molecules. Using this ‘two-photon diagnostic guide’, a coumarin-based 2PA dye was developed; its long-lived ICT state and singlet excited-state diradical ion pairs (DRPs) correlate with a large 2PA cross-section (Fig. 30).[37] Note that in this particular approach, the lifetime of the ICT excited state (which reflects the lifetime of the charge separated (CS) state for these dipolar compounds) is used as a substitute for the  $\Delta r$  parameter mentioned above (Fig. 28).

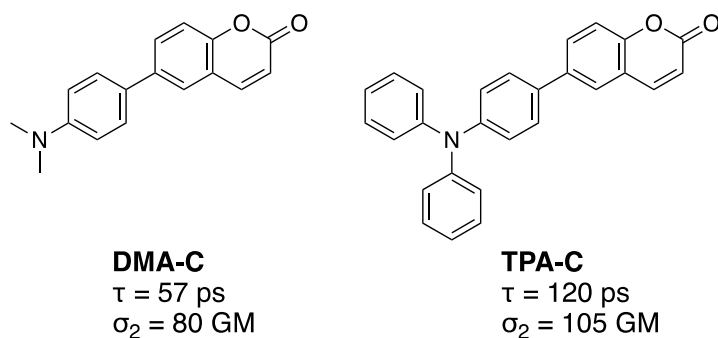


Fig. 30. Coumarin-based 2PA dyes.[37]

### Two-photon absorption: non-bio-oriented applications

The many advantages of 2PA have resulted in a variety of applications, including two-photon fluorescence microscopy (2PA-FM), optical limiting, microfabrication, photodynamic therapy (PDT) and 3D optical data storage. Some examples of these applications are detailed below, and a more extensive discussion focusing on bio-oriented applications (2PA-FM and 2PA-PDT) is presented later.

Microfabrication benefits from the high spatial resolution obtained with 2PA. In this application, the 2PA chromophore is a polymerisation photo-initiator. When excited via 2PA using a pulsed laser beam, the chemical polymerisation induced at the focal point leads to micro-/nano-scale highly resolved objects (Fig. 31).[38]

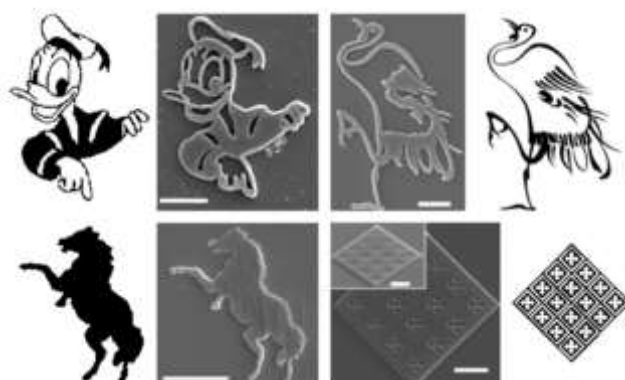
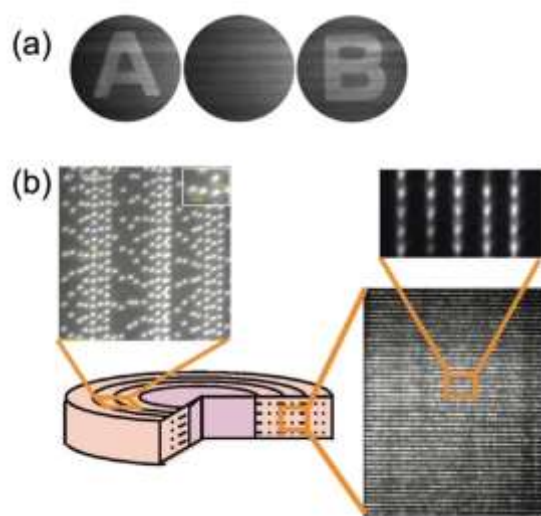


Fig. 31. Examples of 3D microfabrication (5  $\mu\text{m}$  scale bars). Reprinted from Ref.[38] with permission from Elsevier.

2PA is also of interest in three-dimensional optical data storage. This application involves a laser encoding information through photo-switchable molecules. These molecules can usually exist in two distinct states with different optical properties, leading to binary encoded data. Optical data storage on a surface (2D) is commonly used in CD, DVD or Blu-ray discs. The challenge is to continually increase the density of data that can be stored, and this is possible using 2PA to write multiple layers of bits in three dimensions (Fig. 32).[39] Thanks to highly localised excitation and deep penetration, information can be stored at different depths, leading to multiple layers of data, while the scattering of excitation light is reduced by using longer wavelengths. Further optimisation of such 3D data storage devices has involved increasing the speed of writing/reading.



**Fig. 39.** Optical data storage. (a) Written - erased - rewritten images. (b) Multiple layers of data stored in a 3D memory disk. Reused with rights from Ref.<sup>[39]</sup> © 2009, American Chemical Society.

Optical limiting (OL) materials have been developed to prevent eye or sensor damage when manipulating laser beams (Fig. 33). OL devices act as filters, blocking high intensity light sources. OL can be achieved by RSA and/or 2PA. 2PA-based optical limiters require good transparency at low intensities and permit much faster absorption than RSA when the intensity of the incident beam becomes great. OL devices block the intense light source by absorbing it and dissipating the energy as heat. Many optical limiters have been realised, the current challenges being to improve their efficiency (their limiting capability and speed), to control their operating wavelength range and to minimise their cost (for applications in disposable devices).[40]





**Fig. 33.** Laser protective glasses.

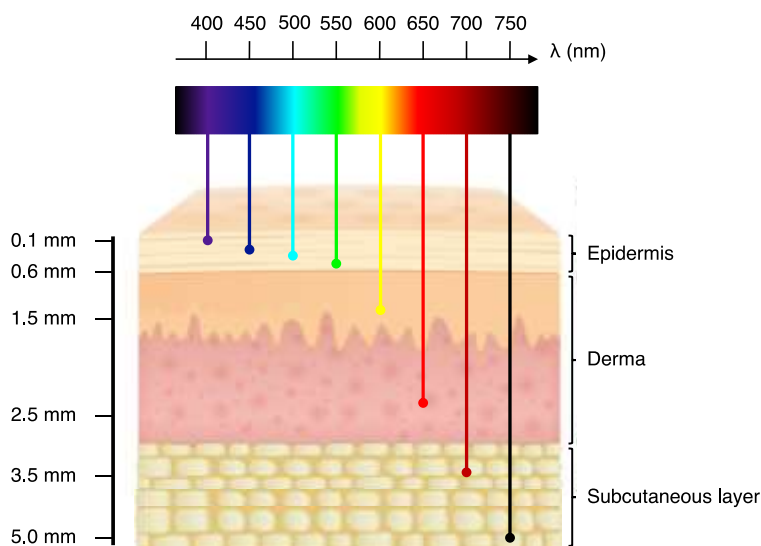
### **Two-photon absorption: bio-oriented applications**

In contrast to 1PA, 2PA offers tight spatial resolution which is very useful in micro-fabrication, optical data storage and bio- imaging. For bio-oriented applications, 2PA has other benefits that can make it an interesting asset in the development of better diagnostic and treatment tools such as two-photon excited fluorescence microscopy (2PA-FM) and two-photon excited photodynamic therapy (2PA-PDT). These advantages and applications will be summarised in the following section, and we will then discuss the design of 2PA chromophores consistent with the biological requirements.

In medicine, three complementary approaches are pursued to help patients: prevention, diagnosis and treatment. 2PA is a promising tool in both diagnosis and treatment of diseases. From the diagnosis point of view, there is a need to develop new biocompatible luminescent probes with low toxicity and strong 2PA, to drive the development of TPEF sensors. From the treatment perspective, two different options can be considered: photoactivated drug delivery and photodynamic therapy (PDT).[41] The two-photon initiated release of an active substance is beyond the scope of this Primer Review, but we note that examples have been reported in the literature.[11] 2PA-PDT follows the same principle as traditional one-photon PDT, that is, the generation of cytotoxic singlet oxygen by the excited photosensitiser. For this application, most compounds undergo intersystem crossing (ISC) from their singlet excited state to their triplet excited state, but no specific relaxation is needed; this can either be radiative or non-radiative in nature. It is noteworthy that, while these tools can be used independently of each other, they can also be combined in theranostic treatment (theranostic is a portmanteau of therapy and diagnostic, and involves a therapeutic strategy combining drug therapy and diagnosis).

As discussed earlier, the simultaneous absorption of two photons can only occur when a molecule is irradiated with an intense laser beam. The high intensity of the light source leads to highly localised excitation at the focal volume, thereby leading to remarkable spatial resolution and better contrast than with 1PA imaging (due to decreased autofluorescence: see below). This distinctive feature helps us to target specific sites and to carry out three-dimensional imaging of cells and tissues, affording better diagnoses and treatments. Furthermore, compared to 1PA, the longer wavelength of the incident light used for 2PA excitation permits a drastic reduction in the scattering of the incident beam when it crosses the sample. The scattered light is of insufficient intensity for subsequent reabsorption via 2PA.[41]

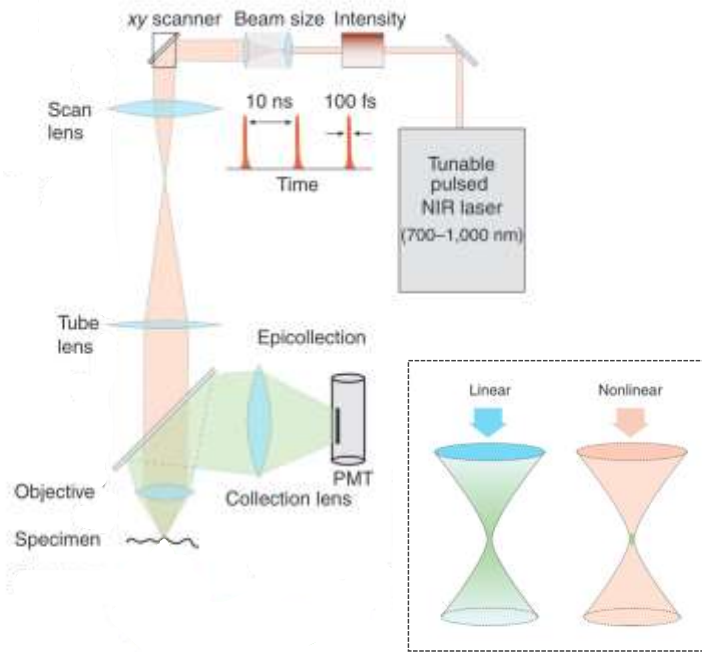
Compared to 1PA, the light source used in 2PA emits much lower energy photons with wavelengths usually located in the near-infrared (NIR) region. Long wavelength irradiation has deeper penetration into skin (Fig. 34). It also reduces autofluorescence of tissues;[42] the NIR excitation wavelengths required for 2PA cannot be absorbed by endogenous chromophores in biological tissue through a one-photon process, leading to a decrease in background autofluorescence. Furthermore, as explained below, it leads to a significant reduction in photodamage.



**Fig. 34.** Penetration depths of light into skin as a function of wavelength.

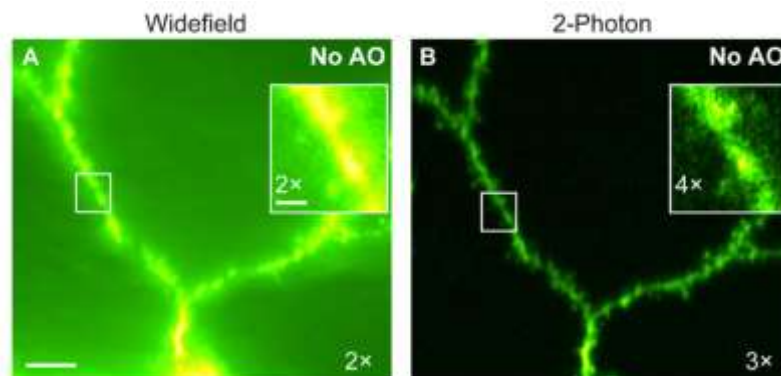
Overall, 2PA overcomes limitations of one-photon excitation techniques by providing greater penetration depth in tissues and somewhat inferior three-dimensional spatial resolution to pinhole-assisted 1PA fluorescence imaging, while it provides better contrast during fluorescence imaging. These advantages have resulted in the development of new diagnostic procedures and curative treatments, such as 2PA-FM and 2PA-PDT.

2PA-FM, which combines the 2PA process with a laser scanning confocal fluorescence microscope, has become a standard device in medicine and biology as a three-dimensional high-resolution, fast and non-invasive observation tool for tissue. The 2PA-FM set-up is similar to a confocal microscope in many respects, the main differences being the intensity of the light source and the detection pathway. In 2PA-FM, a ps- or fs-pulsed laser scans via *xy*-scanning galvo mirrors, and then the beam is expanded by both scan and tube lenses, providing a larger light beam to ‘fill’ the back aperture of the objective. The objective focuses the beam into the sample, which simultaneously absorbs two photons to reach an excited state. The chromophore then relaxes to the ground state by re-emitting a photon. The signal is filtered by a dichroic mirror, recorded by the PMT, and converted into an image (Fig. 35).[42]



**Fig. 35.** Two-photon laser-scanning microscope set-up, and signal spatial confinement in nonlinear absorption (insert). Reused with permission from Springer Nature under the terms of Copyright Clearance Center © F. Helmchen 2005.<sup>[42]</sup>

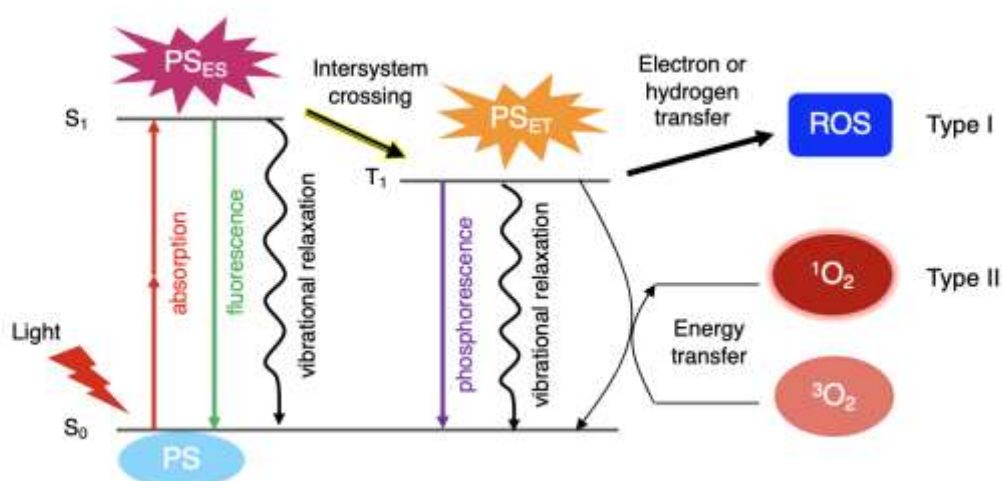
As already mentioned, 2PA absorption microscopy employs multiphoton absorption, and so is spatially confined in the focal region (Fig. 35 – insert), in contrast to a confocal microscope. Thus, this focused excitation is optimal for the long-term imaging of tissue and living cells as it reduces photodamage, leading to increased tissue viability. Highly localised excitation also provides exceptional three-dimensional resolution and contrast for deep optical imaging. The images in Fig. 36 of dendritic structures in mouse brain slices illustrate the resolution differences from two microscopy techniques: widefield (WF) and two-photon excitation, the first one being a 1PA process, and emphasising the remarkable improvement in image distinctness from 2PA that is available from elimination of out-of-focus fluorescence and the reduction in scattering of excitation light.<sup>[43]</sup>



**Fig. 36.** Images of mouse brain slices using widefield (WF) and two-photon excitation microscopies. Scale bar 5  $\mu\text{m}$ ; insets 1  $\mu\text{m}$ . Reused with rights from Ref.<sup>[43]</sup> © 2020 American Association for the Advancement of Science.

Thanks to these advantages, 2PA-FM is regularly used in neuroscience to monitor neuron or synapse activity, in oncology to study the function of cancer cells and tumour movement, and in immunology to investigate the system immune response to antigens. In order to achieve imaging by 2PA-FM, chemists have had to develop new specific dyes: these need to be excited by 2PA, luminesce, and meet the requirements for bio-oriented applications, such as targeting certain cells or organs, and with sufficient solubility in water. One way to evaluate the potential of a dye as a 2PA-FM agent is to determine its two-photon action cross-section, which corresponds to the product of the luminescence quantum yield  $\Phi_L$  and the 2PA cross-section  $\sigma_2$ , *i. e.*  $\Phi_L \times \sigma_2$ . The greater the two-photon action cross-section, the easier the molecule will be to observe by 2PA-FM. Thus, there is a necessity to increase the number of water-soluble 2PA probes possessing large brightness values  $\Phi_L \times \sigma_2$  to achieve efficient two-photon images of cells.[44] The design of 2PA probes for 2PA-FM applications will be discussed below.

Light therapy was known to the ancient Egyptians and Greeks, and rediscovered by scientists at the end of the nineteenth century. The term ‘photodynamic’ was introduced to describe the combined use of light and photosensitisers. Photodynamic therapy has been developed as a promising tool for the treatment of cancers, skin diseases, and bacterial, fungal and viral infections.[41]



**Fig. 37.** Perrin-Jablonski diagram for type I and type II 2PA-PDT mechanisms.

PDT commences with the intravenous or topical administration of a nontoxic photosensitiser (PS) to the patient. The PS is then photoactivated by light irradiation to its excited singlet state (PSES), which can then undergo several processes: vibrational relaxation or fluorescence emission to the ground state, or ISC to the more stable excited triplet state  $T_1$ . These processes are always in competition with one another, so the chemist must introduce specific structural modifications to the PS to favour one over the others. In the case of PDT, ISC to the triplet state is essential, because it is from the triplet state that the

PS can interact with its environment to generate cytotoxic species by Type I or Type II mechanisms. In a Type I process, the PS reacts directly with the biological environment by transferring a proton or an electron to form reactive oxygen species (ROS), radicals that can trigger cell death. Alternatively, in a Type II mechanism, the photosensitiser excited triplet state (PSET) transfers its energy to molecular oxygen ( $^3\text{O}_2$ ) and forms singlet oxygen ( $^1\text{O}_2$ ), which is cytotoxic (Fig. 37).[41]

In photodynamic therapy, the PS can be excited by 1PA, but also by the simultaneous absorption of two photons (2PA-PDT). The use of 2PA improves treatment because it permits deeper penetration of light through tissue as well as photoexcitation in more localised areas, the latter providing enhanced spatial control of where the 'therapy' occurs, and reducing the adverse effects on nearby healthy cells.

As mentioned above, PDT requires a photosensitiser with a high photo-conversion rate from the singlet to the tripletstate. While emissive compounds are not needed to perform PDT, an interesting approach is to develop luminescent PDT- active molecules to couple treatment and imaging. The next section summarises the structural design of chromophores to favour this outcome.

In addition to possessing a large 2PA cross-section  $\sigma_2$ , probes and sensitizers for bio-oriented applications require a significant two-photon brightness  $\Phi_L \times \sigma_2$ , low toxicity, sufficient water-solubility to stain cells and tissues and avoid aggregation in an aqueous environment, high photostability and high specificity for the targeted organs or cells. Extension of the ICT often strongly increases the 2PA cross-section, but an extended charge transfer also tends to decrease the luminescence quantum yield  $\Phi_L$ , leading to diminished two-photon brightness  $\Phi_L \times \sigma_2$ . It is therefore important to find the right balance between a large two-photon cross-section and efficient luminescence de-excitation by optimising the molecular architecture.[44] Fluorescent proteins (FPs), which possess a barrel structure that protects a small dipolar chromophore from the environment, are genetically encoded probes widely used in the 2PA-FM of living cells and brain tissue[43] (Fig. 36), due to their biocompatibility and targeting. Although the peak 2PA cross-section of wild-type green-fluorescent protein (GFP) is only 12 GM, those of mutant FPs are usually higher (e.g. 39 GM for enhanced GFP (eGFP) and 112 GM for red fluorescent protein DsRed2).[45]

The luminescence quantum yields in aqueous media, *i.e.* water, are often dramatically lower than those in aprotic solvents such as benzene or dichloromethane; hydrogen-bonding favours non-radiative decay by decreasing the excited-state lifetime through a process called hydrogen bond-induced nonradiative deactivation (HBIND). The mechanism of HBIND has been studied using transient infrared spectroscopy, revealing that, in water, the chromophore can be viewed as part of an extended hydrogen-bonding network, leading to enhanced internal conversion, and thereby a nonradiative deactivation. Water-solubility can be increased by reducing the size of the chromophore and incorporating water-soluble substituents to change the global solubility of the molecule;[44] for example, insertion of polyethylene glycol (PEG) chains has solubilised a hydrophobic porphyrin core for two-photon bio-imaging

and PDT applications,[46] while perylene-3,4,9,10-tetracarboxylic diimide (PDI) cores have been dendrimerised with cationic protonated amines to enhance water solubility[47] (Fig. 38).

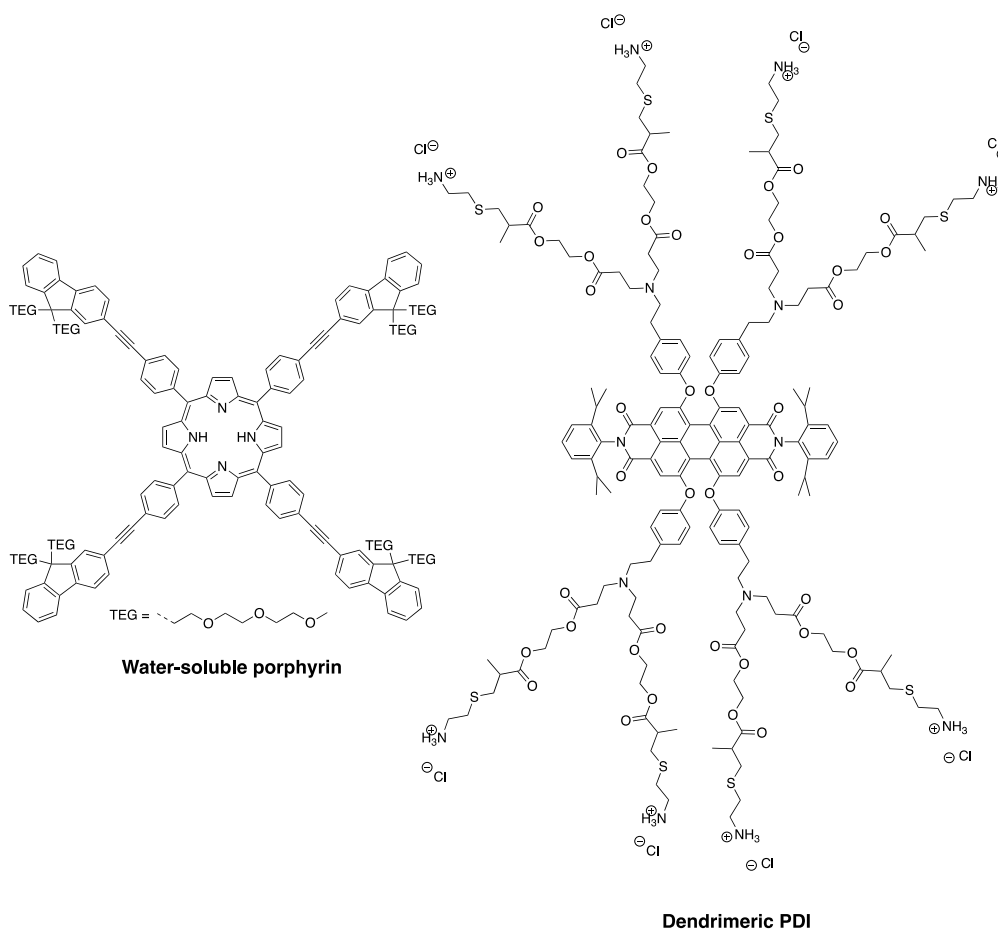
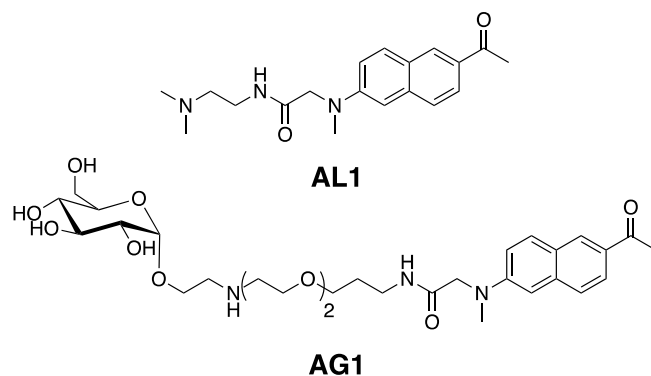


Fig. 38. Water-soluble 2PA chromophores.[46,47]

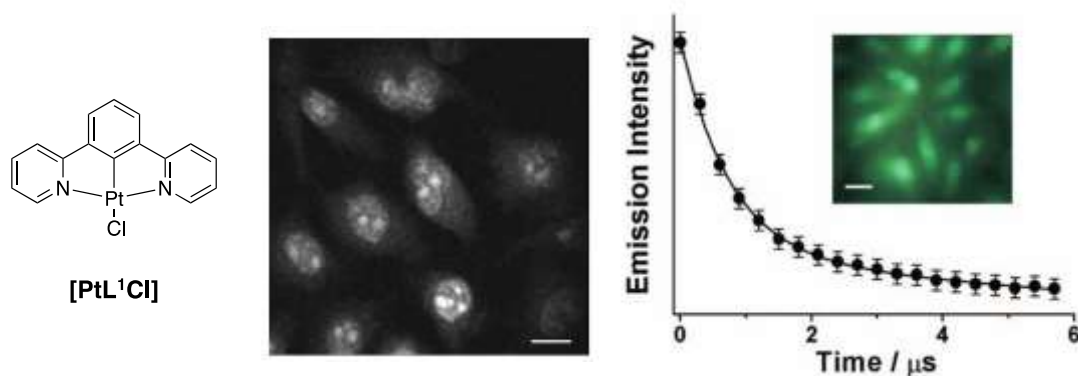
Several routes have been explored to improve the photostability of organic dyes, such as the addition of stabilisers, or nano-encapsulation, while reducing the number of oxidisable functional groups and insertion of electron-withdrawing groups tends to decrease the photobleaching.[48] Two main strategies have been employed to electron-withdrawing groups tends to decrease the photobleaching.[48]

Two main strategies have been employed to engineer probes with improved targeting. The chromophore can be designed to include specific groups able to directly accumulate in certain cells, such as lysosomes or tumors; for example, the two-photon LysoTracker **AL1** uses a tertiary amine linked to an AceDAN moiety, because amino groups are readily protonated and will accumulate in the lysosomes after internalisation.[49] The other approach is to directly connect a biomolecule to the fluorophore; for example, a glucose unit has been added in **AG1**, facilitating observation of cancer cells[50] (Fig. 39).

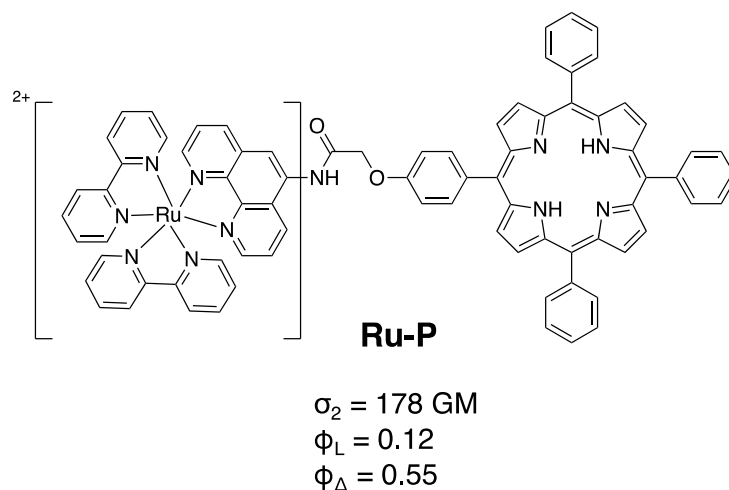


**Fig. 39.** Structures of LysoTracker **AL1** and targeted probe **AG1**.<sup>[49]</sup>

Structural modifications that induce a higher probability of ISC from the singlet to the triplet state are needed for long-life TPE-imaging and 2PA-PDT applications. The most common way to improve this rate is through the heavy-atom effect, by including halogen atoms (e.g. Cl, Br, I), metal atoms (e.g. Zn, Ru, Pd, Pt) or heteroatoms (e.g. P, S) into the structure of the chromophore.<sup>[51]</sup> The heavy-atom effect corresponds to enhancement of the rate of ISC, a spin-forbidden process, by spin-orbit coupling, because spin-orbit coupling increases in the presence of atoms of high atomic number. The insertion of specific atoms favours ICT and can lead to emission in the microsecond domain, i.e. phosphorescence (Fig. 40),<sup>[33]</sup> while the use of carefully selected coordination spheres or surroundings around these heavy atoms can also favour the generation of cytotoxic singlet oxygen quantified by  $\phi\Delta$  (Fig. 41).<sup>[52]</sup>



**Fig. 40.** TPEF images of live Chinese hamster ovary cells incubated with **[PtL<sup>1</sup>Cl]** and exhibiting emission in the micro-second domain. Reused with permission © 2008 National Academy of Sciences.<sup>[33]</sup>



**Fig. 41.** A ruthenium complex-porphyrin hybrid (**Ru-P**) for combined TP-imaging and 2PA-PDT applications. 2PA cross-section  $\sigma_2$  measured by fs Z-scan, luminescence quantum yield  $\phi_L$  measured in benzene, and singlet oxygen quantum yield  $\phi_\Delta$  measured in chloroform.<sup>[52]</sup>

## Conclusion

In this brief overview, we have described how second- and third-order NLO effects have profoundly impacted the field of photoactive substances. Although their systematic study was only initiated in the late 1960s, many of these remarkable light-induced phenomena hold promise for ultrafast information processing in the future, using photons instead of electrons. In terms of everyday practical realisation, 2PA has been the most fruitful of these phenomena. While 2PA has opened a wealth of new opportunities for the synthetic chemist in the design of innovative molecules (or materials), it is in the field of biophotonics that it has most clearly addressed a strong societal demand.

Thus, for photo-imaging and curing, two-photon excitation has crucial advantages over the more traditional one-photon excitation: it can afford exquisite three-dimensional resolution, an increased penetration depth in biological materials such as tissue and highly focused excitation at half-energy, resulting in decreased auto-fluorescence and photodamage. From a synthetic standpoint, simple structure–2PA property studies have revealed that certain molecular design elements favour efficient 2PA, such as multipolar structures with strongly polarising substituents, extended  $\pi$ -systems and possibly incorporation of carefully selected group-8 transition metal atoms. Additional requirements for biological applications include significant two-photon brightness  $\phi_L \times \sigma_2$ , low toxicity, sufficient water-solubility to stain cells and tissues and avoid aggregation in an aqueous environment and high organ/cell specificity. This is therefore a multi-dimensional problem where the optimisation of one parameter sometimes leads to the decrease in performance of another. There is a fascinating challenge for chemists getting involved in the field of finding the right balance between these multiple variables, and thereby developing new 2PA chromophores that fulfil the multifarious requirements for a given task.



**Data availability.** This is a review. There are no original data.

**Conflicts of interest.** The authors declare no conflicts of interest.

**Declaration of funding.** M.G.H. and F.P. thank the ANU-CNRS Collaboration Program for travel and PhD co-tutelle stipend support through the project 'New Organometallic Multipolar Compounds with Enhanced Nonlinear Optical Properties for Bio-oriented Applications'. M.G.H. thanks the Australian Research Council for support (DP220100111). M.D. thanks the CNRS for a co-tutelle PhD postgraduate research stipend and the ANU for a postgraduate fee waiver through the ANU-CNRS Collaboration Program.

## References

- [1] He GS, Tan L-S, Zheng Q, Prasad PN. Multiphoton Absorbing Materials: Molecular Designs, Characterizations, and Applications. *Chem Rev* 2008; 108: 1245–1330. doi:[10.1021/cr050054x](https://doi.org/10.1021/cr050054x)
- [2] Göppert-Mayer M. Über Elementarakte mit zwei Quantensprüngen. *Ann Phys* 1931; 401: 273–294. [In German] doi:[10.1002/andp.19314010303](https://doi.org/10.1002/andp.19314010303)
- [3] Franken PA, Hill AE, Peters CW, Weinreich G. Generation of Optical Harmonics. *Phys Rev Lett* 1961; 7: 118–119. doi:[10.1103/PhysRevLett.7.118](https://doi.org/10.1103/PhysRevLett.7.118)
- [4] Corn RM, Higgins DA. Optical Second Harmonic Generation as a Probe of Surface Chemistry. *Chem Rev* 1994; 94: 107–125. doi:[10.1021/cr00025a004](https://doi.org/10.1021/cr00025a004)
- [5] Eisenthal KB. Liquid Interfaces Probed by Second-Harmonic and Sum-Frequency Spectroscopy. *Chem Rev* 1996; 96: 1343–1360. doi:[10.1021/cr9502211](https://doi.org/10.1021/cr9502211)
- [6] Prasad PN, Williams DJ. *Nonlinear Optical Effects in Molecules and Polymers*. New York: John Wiley & Sons; 1991.
- [7] Dalton LR, Sullivan PA, Bale DH. Electric Field Poled Organic Electro-Optic Materials: State of the Art and Future Prospects. *Chem Rev* 2010; 110: 25–55. doi:[10.1021/cr9000429](https://doi.org/10.1021/cr9000429)
- [8] Barlow AM, Mostaçõ-Guidolin LB, Osei ET, Booth S, Hackett T-L. Super Resolution Measurement of Collagen Fibers in Biological Samples: Validation of a Commercial Solution for Multiphoton Microscopy. *PLoS One* 2020; 15: e0229278. doi:[10.1371/journal.pone.0229278](https://doi.org/10.1371/journal.pone.0229278)
- [9] Ho PP, Alfano RR. Optical Kerr Effect in Liquids. *Phys Rev A* 1979; 20: 2170–2187. doi:[10.1103/PhysRevA.20.2170](https://doi.org/10.1103/PhysRevA.20.2170)

- [10] Perry JW, Alvarez D, Choong I, Mansour K, Marder SR, Perry KJ. Enhanced Reverse Saturable Absorption and Optical Limiting in Heavy-Atom-Substituted Phthalocyanines. *Opt Lett* 1994; 19: 625–627. doi:[10.1364/OL.19.000625](https://doi.org/10.1364/OL.19.000625)
- [11] Pawlicki M, Collins HA, Denning RG, Anderson HL. Two-Photon Absorption and the Design of Two-Photon Dyes. *Angew Chem Int Ed* 2009; 48: 3244–3266. doi:[10.1002/anie.200805257](https://doi.org/10.1002/anie.200805257)
- [12] Peticolas WL, Goldsborough JP, Rieckhoff KE. Double Photon Excitation in Organic Crystals. *Phys Rev Lett* 1963; 10: 43–45. doi:[10.1103/PhysRevLett.10.43](https://doi.org/10.1103/PhysRevLett.10.43)
- [13] Grelaud G, Cifuentes MP, Paul F, Humphrey MG. Group 8 Metal Alkynyl Complexes for Nonlinear Optics. *J Organomet Chem* 2014; 751: 181–200. doi:[10.1016/j.jorganchem.2013.10.008](https://doi.org/10.1016/j.jorganchem.2013.10.008)
- [14] Reinhardt BA, Brott LL, Clarson SJ, Dillard AG, Bhatt JC, Kannan R, Yuan L, He GS, Prasad PN. Highly Active Two-Photon Dyes: Design, Synthesis, and Characterization toward Application. *Chem Mater* 1998; 10: 1863–1874. doi:[10.1021/cm980036e](https://doi.org/10.1021/cm980036e)
- [15] Albota M, Beljonne D, Brédas J-L, Ehrlich JE, Fu J-Y, Heikal AA, Hess SE, Kogej T, Levin MD, Marder SR, McCord-Maughon D, Perry JW, Röckel H, Rumi M, Subramaniam G, Webb WW, Wu X-L, Xu C. Design of Organic Molecules with Large Two-Photon Absorption Cross Sections. *Science* 1998; 281(5383): 1653–1656. doi:[10.1126/science.281.5383.1653](https://doi.org/10.1126/science.281.5383.1653)
- [16] Beljonne D, Wenseleers W, Zojer E, Shuai Z, Vogel H, Pond SJK, Perry JW, Marder SR, Brédas J-L. Role of dimensionality on the two-photon absorption response of conjugated molecules: the case of octupolar compounds. *Adv. Funct. Mater.* 2002; 12: 631–641. doi:[10.1002/1616-3028\(20020916\)12:9<631::AID-ADFM631>3.0.CO;2-W](https://doi.org/10.1002/1616-3028(20020916)12:9<631::AID-ADFM631>3.0.CO;2-W)
- [17] Strehmel B, Sarker AM, Detert H. The Influence of  $\sigma$  and  $\pi$  Acceptors on Two-Photon Absorption and Solvatochromism of Dipolar and Quadrupolar Unsaturated Organic Compounds. *ChemPhysChem* 2003; 4: 249–259. doi:[10.1002/cphc.200390041](https://doi.org/10.1002/cphc.200390041)
- [18] Lin T-C, He GS, Prasad PN, Tan L-S. Degenerate Nonlinear Absorption and Optical Power Limiting Properties of Asymmetrically Substituted Stilbenoid Chromophores. *J Mater Chem* 2004; 14: 982–991. doi:[10.1039/b313185h](https://doi.org/10.1039/b313185h)
- [19] Mongin O, Porrès L, Charlot M, Katan C, Blanchard-Desce M. Synthesis, Fluorescence, and Two-Photon Absorption of a Series of Elongated Rodlike and Banana-Shaped Quadrupolar Fluorophores: A Comprehensive Study of Structure–Property Relationships. *Chem Eur J* 2007; 13: 1481–1498. doi:[10.1002/chem.200600689](https://doi.org/10.1002/chem.200600689)

- [20] Kim HM, Yang WJ, Kim CH, Park W-H, Jeon S-J, Cho BR. Two- Photon Dyes Containing Heterocyclic Rings with Enhanced Photostability. *Chem Eur J* 2005; 11: 6386–6391. doi:[10.1002/chem.200500341](https://doi.org/10.1002/chem.200500341)
- [21] Zyss J, Ledoux I. Nonlinear Optics in Multipolar Media: Theory and Experiment. *Chem Rev* 1994; 94: 77–105. doi:[10.1021/cr00025a003](https://doi.org/10.1021/cr00025a003)
- [22] Chung S-J, Kim K-S, Lin T-C, He GS, Swiatkiewicz J, Prasad PN. Cooperative Enhancement of Two-Photon Absorption in Multi- branched Structures. *J Phys Chem B* 1999; 103: 10741–10745. doi:[10.1021/jp992846z](https://doi.org/10.1021/jp992846z)
- [23] Cui Y-Z, Fang Q, Xue G, Xu G-B, Yin L, Yu W-T. Cooperative Enhancement of Two-Photon Absorption of Multibranching Compounds with Vinylenes Attaching to the *s*-Triazine Core. *Chem Lett* 2005; 34: 644–645. doi:[10.1246/cl.2005.644](https://doi.org/10.1246/cl.2005.644)
- [24] McDonagh AM, Humphrey MG, Samoc M, Luther-Davies B. Organometallic Complexes for Nonlinear Optics. 17.1 Synthesis, Third-Order Optical Nonlinearities, and Two-Photon Absorption Cross Section of an Alkynylruthenium Dendrimer. *Organometallics* 1999; 18: 5195–5197. doi:[10.1021/om9908130](https://doi.org/10.1021/om9908130)
- [25] Picot A, Malvolti F, Le Guennic B, Baldeck PL, Williams JAG, Andraud C, Maury O. Two-Photon Antenna Effect Induced in Octupolar Europium Complexes. *Inorg Chem* 2007; 46: 2659–2665. doi:[10.1021/ic062181x](https://doi.org/10.1021/ic062181x)
- [26] Cho BR, Son KH, Lee SH, Song Y-S, Lee Y-K, Jeon S-J, Choi JH, Lee H, Cho M. Two Photon Absorption Properties of 1,3,5-Tricyano- 2,4,6-Tris(Styryl)Benzene Derivatives. *J Am Chem Soc* 2001; 123: 10039–10045. doi:[10.1021/ja010770q](https://doi.org/10.1021/ja010770q)
- [27] Kuzyk MG. Using Fundamental Principles to Understand and Optimize Nonlinear-optical Materials. *J Mater Chem* 2009; 19: 7444–7465. doi:[10.1039/b907364g](https://doi.org/10.1039/b907364g)
- [28] Yoon M-C, Noh SB, Tsuda A, Nakamura Y, Osuka A, Kim D. Photophysics of meso- $\beta$  Doubly Linked Ni(II) Porphyrin Arrays: Large Two-Photon Absorption Cross-Section and Fast Energy Relaxation Dynamics. *J Am Chem Soc* 2007; 129: 10080–10081. doi:[10.1021/ja0735655](https://doi.org/10.1021/ja0735655)
- [29] Cifuentes MP, Powell CE, Humphrey MG, Heath GA, Samoc M, Luther-Davies B. Organometallic Complexes for Nonlinear Optics. 24. Reversible Electrochemical Switching of Nonlinear Absorption. *J Phys Chem A* 2001; 105: 9625–9627. doi:[10.1021/jp012138p](https://doi.org/10.1021/jp012138p)
- [30] Roberts RL, Schwich T, Corkery TC, Cifuentes MP, Green KA, Farmer JD, Low PJ, Marder TB, Samoc M, Humphrey MG. Organometallic Complexes for Nonlinear Optics. 45. Dispersion of the Third-

Order Nonlinear Optical Properties of Triphenylamine- Cored Alkynylruthenium Dendrimers. *Adv Mater* 2009; 21: 2318–2322. doi:[10.1002/adma.200803669](https://doi.org/10.1002/adma.200803669)

- [31] Hurst SK, Humphrey MG, Morrall JP, Cifuentes MP, Samoc M, Luther-Davies B, Heath GA, Willis AC. Organometallic Complexes for Nonlinear Optics: Part 31. Cubic Hyperpolarizabilities of Ferrocenyl-Linked Gold and Ruthenium Complexes. *J Organomet Chem* 2003; 670: 56–65. doi:[10.1016/S0022-328X\(02\)02131-9](https://doi.org/10.1016/S0022-328X(02)02131-9)
- [32] Samoc M, Gauthier N, Cifuentes MP, Paul F, Lapinte C, Humphrey MG. Electrochemical Switching of the Cubic Nonlinear Optical Properties of an Aryldiethynyl-Linked Heterobimetallic Complex between Three Distinct States. *Angew Chem Int Ed* 2006; 45: 7376–7379. doi:[10.1002/anie.200602684](https://doi.org/10.1002/anie.200602684)
- [33] Botchway SW, Charnley M, Haycock JW, Parker AW, Rochester DL, Weinstein JA, Williams JAG. Time-Resolved and Two-Photon Emission Imaging Microscopy of Live Cells with Inert Platinum Complexes. *Proc Natl Acad Sci* 2008; 105: 16071–16076. doi:[10.1073/pnas.0804071105](https://doi.org/10.1073/pnas.0804071105)
- [34] Sekiguchi Y, Yamashita T, Vacha M. Effect of Ligands in Two-Photon Excited Luminescence of Organometallic Iridium Complexes. *J Lumin* 2008; 128: 848–850. doi:[10.1016/j.jlumin.2007.11.046](https://doi.org/10.1016/j.jlumin.2007.11.046)
- [35] Murugan NA, Zaleśny R, Kongsted J, Nordberg A, Ågren H. Promising Two-Photon Probes for in Vivo Detection of  $\beta$  Amyloid Deposits. *Chem Commun* 2014; 50: 11694–11697. doi:[10.1039/C4CC03897E](https://doi.org/10.1039/C4CC03897E)
- [36] Sun C-L, Liao Q, Li T, Li J, Jiang J-Q, Xu Z-Z, Wang X-D, Shen R, Bai D-C, Wang Q, Zhang S-X, Fu H-B, Zhang H-L. Rational Design of Small Indolic Squaraine Dyes with Large Two-Photon Absorption Cross Section. *Chem Sci* 2015; 6: 761–769. doi:[10.1039/C4SC02165G](https://doi.org/10.1039/C4SC02165G)
- [37] Zheng Y, Sun S, Xu L, Ni S, Liu W, Huang B, Huang Q, Zhang Q, Lu F, Li M-D. Arylamine-Coumarin Based Donor-Acceptor Dyads: Unveiling the Relationship between Two-Photon Absorption Cross-Section and Lifetime of Singlet Excited State Intramolecular Charge Separation. *Dyes Pigments* 2019; 165: 301–307. doi:[10.1016/j.dyepig.2019.02.032](https://doi.org/10.1016/j.dyepig.2019.02.032)
- [38] Lee K-S, Kim RH, Yang D-Y, Park SH. Advances in 3D Nano/ Microfabrication Using Two-Photon Initiated Polymerization. *Prog Polym Sci* 2008; 33: 631–681. doi:[10.1016/j.progpolymsci.2008.01.001](https://doi.org/10.1016/j.progpolymsci.2008.01.001)
- [39] Dvornikov AS, Walker EP, Rentzepis PM. Two-Photon Three- Dimensional Optical Storage Memory. *J Phys Chem A* 2009; 113: 13633–13644. doi:[10.1021/jp905655z](https://doi.org/10.1021/jp905655z)
- [40] Dini D, Calvete MJF, Hanack M. Nonlinear Optical Materials for the Smart Filtering of Optical Radiation. *Chem Rev* 2016; 116: 13043–13233. doi:[10.1021/acs.chemrev.6b00033](https://doi.org/10.1021/acs.chemrev.6b00033)

- [41] Ogilby PR. Singlet Oxygen: There Is Indeed Something New under the Sun. *Chem Soc Rev* 2010; 39: 3181–3209. doi:[10.1039/b926014p](https://doi.org/10.1039/b926014p)
- [42] Helmchen F, Denk W. Deep Tissue Two-Photon Microscopy. *Nat Methods* 2005; 2: 932–940. doi:[10.1038/nmeth818](https://doi.org/10.1038/nmeth818)
- [43] Li Z, Zhang Q, Chou S-W, Newman Z, Turcotte R, Natan R, Dai Q, Isacoff EY, Ji N. Fast Widefield Imaging of Neuronal Structure and Function with Optical Sectioning in Vivo. *Sci Adv* 2020; 6(19): eaaz3870. doi:[10.1126/sciadv.aaz3870](https://doi.org/10.1126/sciadv.aaz3870)
- [44] Kim HM, Cho BR. Small-Molecule Two-Photon Probes for Bioimaging Applications. *Chem Rev* 2015; 115: 5014–5055. doi:[10.1021/cr5004425](https://doi.org/10.1021/cr5004425)
- [45] Drobizhev M, Makarov NS, Tillo SE, Hughes TE, Rebane A. Two-photon Absorption Properties of Fluorescent Proteins. *Nat Methods* 2011; 8: 393–399. doi:[10.1038/nmeth.1596](https://doi.org/10.1038/nmeth.1596)
- [46] Shi L, Nguyen C, Daurat M, Dhieb AC, Smirani W, Blanchard-Desce M, Gary-Bobo M, Mongin O, Paul-Roth C, Paul F. Biocompatible Conjugated Fluorenylporphyrins for Two-Photon Photodynamic Therapy and Fluorescence Imaging. *Chem Commun* 2019; 55: 12231–12234. doi:[10.1039/C9CC05657B](https://doi.org/10.1039/C9CC05657B)
- [47] Xu Z, He B, Shen J, Yang W, Yin M. Fluorescent Water-Soluble Perylene-3,4,9,10-tetracarboxylic diimide-Cored Cationic Dendrimers: Synthesis, Optical Properties, and Cell Uptake. *Chem Commun* 2013; 49: 3646–3648. doi:[10.1039/c3cc40330k](https://doi.org/10.1039/c3cc40330k)
- [48] Liphardt B, Liphardt B, Lüttke W. Laser Dyes III: Concepts to Increase the Photostability of Laser Dyes. *Opt Commun* 1983; 48: 129–133. doi:[10.1016/0030-4018\(83\)90372-3](https://doi.org/10.1016/0030-4018(83)90372-3)
- [49] Kim HM, An MJ, Hong JH, Jeong BH, Kwon O, Hyon J-Y, Hong S-C, Lee KJ, Cho BR. Two-Photon Fluorescent Probes for Acidic Vesicles in Live Cells and Tissue. *Angew Chem Int Ed* 2008; 47: 2231–2234. doi:[10.1002/anie.200704586](https://doi.org/10.1002/anie.200704586)
- [50] Tian YS, Lee HY, Lim CS, Park J, Kim HM, Shin YN, Kim ES, Jeon HJ, Park SB, Cho BR. A Two-Photon Tracer for Glucose Uptake. *Angew Chem Int Ed* 2009; 48: 8027–8031. doi:[10.1002/anie.200901175](https://doi.org/10.1002/anie.200901175)
- [51] Xu L, Zhang J, Yin L, Long X, Zhang W, Zhang Q. Recent Progress in Efficient Organic Two-Photon Dyes for Fluorescence Imaging and Photodynamic Therapy. *J Mater Chem C* 2020; 8: 6342–6349. doi:[10.1039/D0TC00563K](https://doi.org/10.1039/D0TC00563K)
- [52] Poon C-T, Chan P-S, Man C, Jiang F-L, Wong RNS, Mak N-K, Kwong DWJ, Tsao S-W, Wong W-K. An Amphiphilic Ruthenium (II)–Polypyridyl Appended Porphyrin as Potential Bifunctional Two-Photon Tumor-Imaging and Photodynamic Therapeutic Agent. *J Inorg Biochem* 2010; 104: 62–70. doi:[10.1016/j.jinorgbio.2009.10.004](https://doi.org/10.1016/j.jinorgbio.2009.10.004)

