

# Modelling and Simulation of PCB Embedded Power Electronic Layouts

ECPE Workshop “Embedding and Advanced Integration  
Technologies in Power Electronics”



**Cyril BUTTAY<sup>A</sup>, Bahaeddine BEN HAMED<sup>M</sup>, Ahmed AHMED<sup>M</sup>,  
Guillaume REGNAT<sup>M</sup>, Rémi PERRIN<sup>M</sup>**

<sup>A</sup> Laboratoire Ampère, Lyon, France

<sup>M</sup> Mitsubishi Electric R&D Centre Europe, Rennes, France

# Outline

- 1 Current design tools for power electronics
- 2 Proposition for PCB-embedded electronics
- 3 Export from eCAD
- 4 Electrical model
- 5 Thermal model
- 6 Conclusion

# Outline

- 1 Current design tools for power electronics
- 2 Proposition for PCB-embedded electronics
- 3 Export from eCAD
- 4 Electrical model
- 5 Thermal model
- 6 Conclusion

# Design in Power Electronics – Current State



Specifications

# Design in Power Electronics – Current State



# Design in Power Electronics – Current State

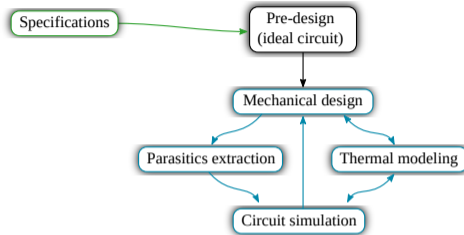

- Implementation is a complex affair:

# Design in Power Electronics – Current State

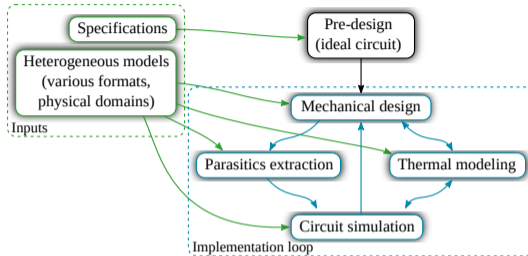

- Implementation is a complex affair:
  - No unified description

# Design in Power Electronics – Current State

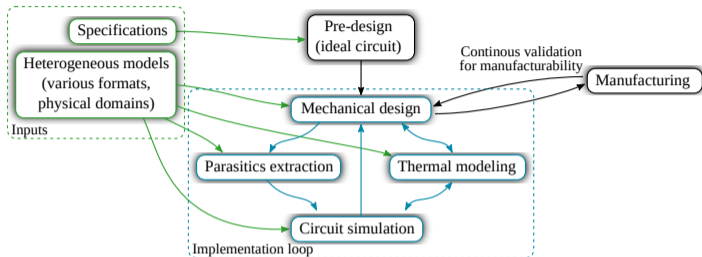

- Implementation is a complex affair:
  - No unified description
  - Or design rules...



# Design in Power Electronics – Current State

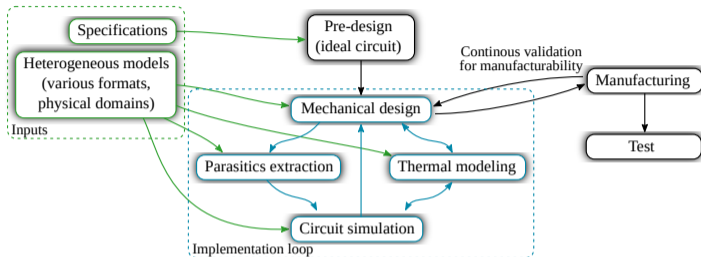

- Implementation is a complex affair:
  - No unified description
  - Or design rules...

# Design in Power Electronics – Current State

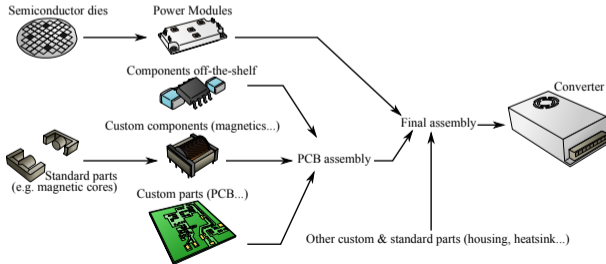
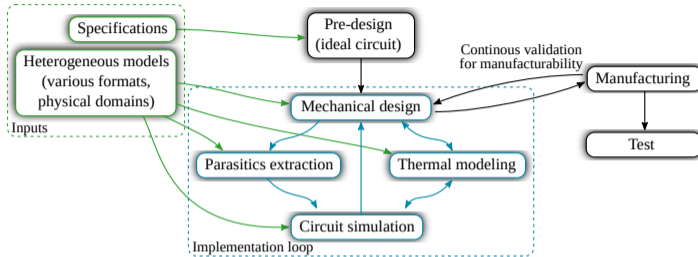

- Implementation is a complex affair:
  - No unified description
  - Or design rules...
- ... Because of heterogeneous construction!

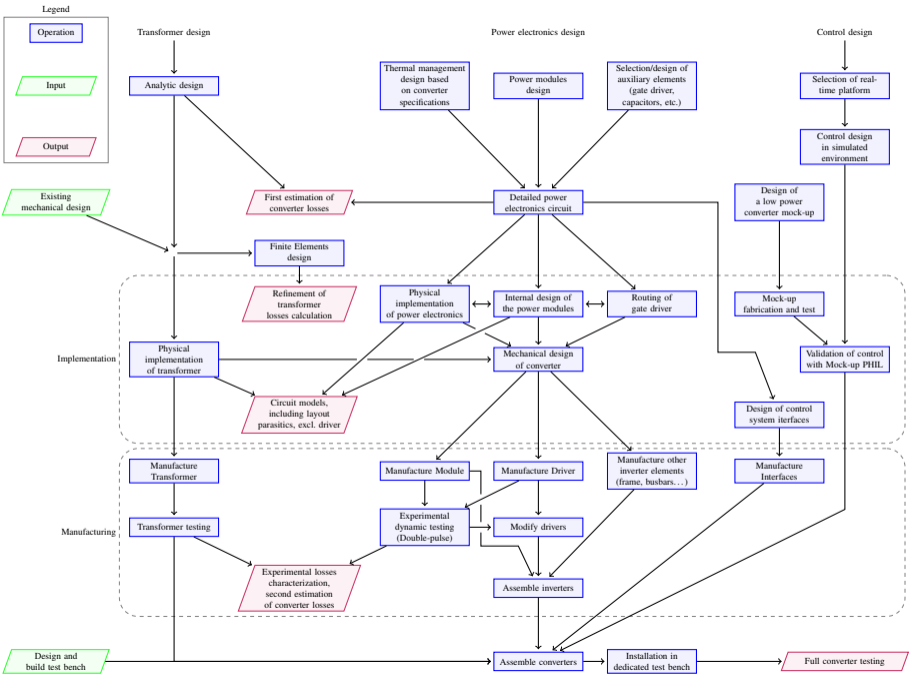

test case: 100 kW DC/DC

Circuit simulation nearly impossible:

- complex to set up
- complex to run
- untrusted

Source: Supergrid Institute, discussed in [1]

# Motivation



- Virtual prototyping has been discussed for decades
  - + Fostered by more powerful computers, more capable software
  - Hampered by lack of unified description, poor models

# Motivation



- Virtual prototyping has been discussed for decades
  - + Fostered by more powerful computers, more capable software
  - Hampered by lack of unified description, poor models
- It is needed more than ever!
  - Integration means costlier prototypes, with longer lead times
  - Integrated systems cannot be debugged/repaired!

- Virtual prototyping has been discussed for decades
    - + Fostered by more powerful computers, more capable software
    - Hampered by lack of unified description, poor models
  - It is needed more than ever!
    - Integration means costlier prototypes, with longer lead times
    - Integrated systems cannot be debugged/repaired!
- **Can we generate virtual prototypes for PCB embedded-electronics?**

# Outline

- 1 Current design tools for power electronics
- 2 Proposition for PCB-embedded electronics**
- 3 Export from eCAD
- 4 Electrical model
- 5 Thermal model
- 6 Conclusion

# Design in Power Electronics – Proposition

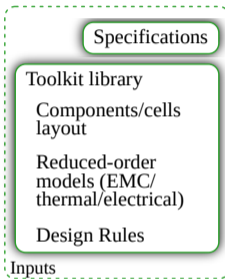
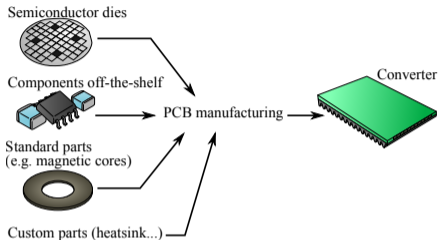

PCB (embedding) can bring:

- more rationalized manufacturing:
  - fewer packaging levels
  - single-board-converters
- one-stop design tool (eCAD):
  - complete description of a design
  - design-rules validation (design for manufacturing)



# Design in Power Electronics – Proposition

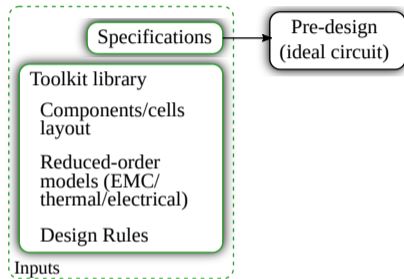
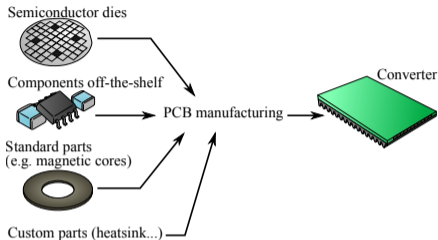

PCB (embedding) can bring:

- more rationalized manufacturing:
  - fewer packaging levels
  - single-board-converters
- one-stop design tool (eCAD):
  - complete description of a design
  - design-rules validation (design for manufacturing)

# Design in Power Electronics – Proposition

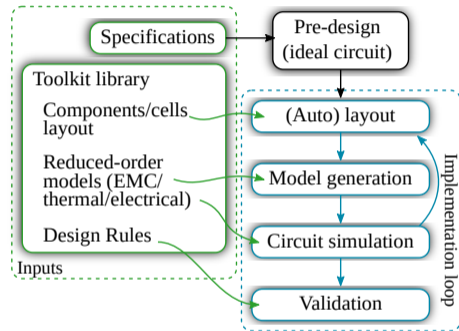
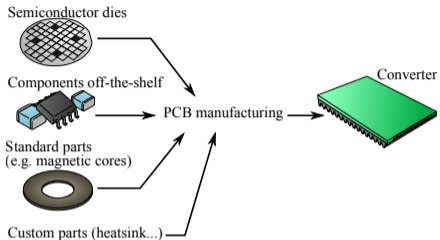

PCB (embedding) can bring:

- more rationalized manufacturing:
  - fewer packaging levels
  - single-board-converters
- one-stop design tool (eCAD):
  - complete description of a design
  - design-rules validation (design for manufacturing)

# Design in Power Electronics – Proposition

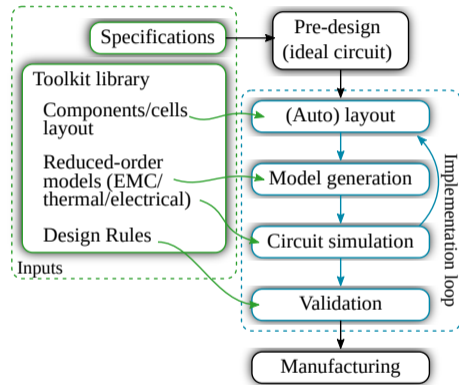
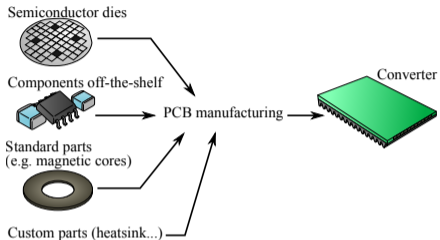

PCB (embedding) can bring:

- more rationalized manufacturing:
  - fewer packaging levels
  - single-board-converters
- one-stop design tool (eCAD):
  - complete description of a design
  - design-rules validation (design for manufacturing)

# Design in Power Electronics – Proposition

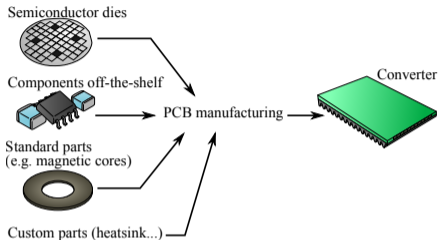

PCB (embedding) can bring:

- more rationalized manufacturing:
  - fewer packaging levels
  - single-board-converters
- one-stop design tool (eCAD):
  - complete description of a design
  - design-rules validation (design for manufacturing)

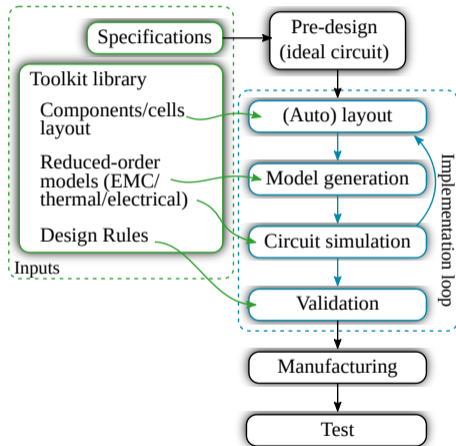

## The entire structure of a PCB-embedded converter is described in the eCAD tool

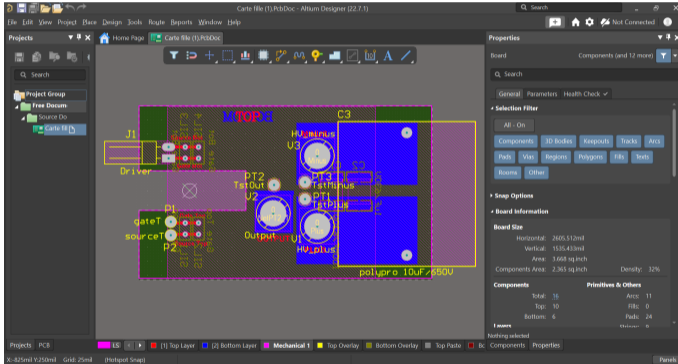

- Layout

## The entire structure of a PCB-embedded converter is described in the eCAD tool

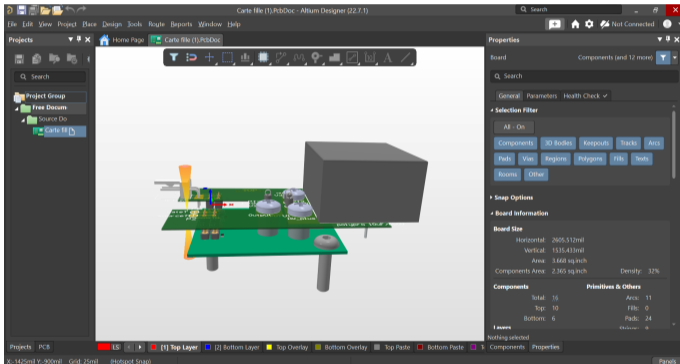

- Layout
- Component location
- Z-positioning

## The entire structure of a PCB-embedded converter is described in the eCAD tool

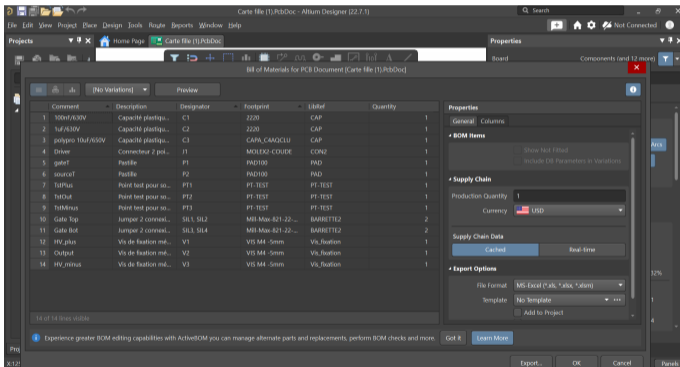

The screenshot displays the eCAD tool interface in Altium Designer. The main window shows a 'Bill of Materials for PCB Document' table with columns for Comment, Description, Designator, Footprint, Libref, and Quantity. The Properties panel on the right is open, showing sections for BOM Items, Supply Chain, and Export Options.

Comment	Description	Designator	Footprint	Libref	Quantity	
1	100nF/630V	C1	2220	CAP	1	
2	1uF/630V	C2	2220	CAP	1	
3	polypro 10uF/630V	C3	CAPA_CAAQCLU	CAP	1	
4	Driver	Connecteur 2 poi...	MOLEX2-COULDE	CON2	1	
5	gateT	Pasfile	PAD100	PAD	1	
6	sourceT	Pasfile	PAD100	PAD	1	
7	TdPlus	Point test pour so...	PT-TEST	PT-TEST	1	
8	TdOut	Point test pour so...	PT-TEST	PT-TEST	1	
9	TdMinus	Point test pour so...	PT-TEST	PT-TEST	1	
10	Gate Top	Jumpor 2 cornes...	SIL3, SIL2	MIL-Max-821-22-...	BARBETTE2	2
11	Gate Bot	Jumpor 2 cornes...	SIL3, SIL4	MIL-Max-821-22-...	BARBETTE2	2
12	HV_plus	Vis de fixation mé...	V3	VIS M4 -5mm	Vis_foitation	1
13	Output	Vis de fixation mé...	V2	VIS M4 -5mm	Vis_foitation	1
14	HV_minus	Vis de fixation mé...	V3	VIS M4 -5mm	Vis_foitation	1

**Properties Panel:**

- General:** Columns
- BOM Items:** Show Not Filled, Include DB Parameters in Variations
- Supply Chain:** Production Quantity: 1, Currency: USD
- Supply Chain Data:** Cached, Real-time
- Export Options:** File Format: MS-Excel (\*.xls, \*.xlsx, \*.xlsm), Template: No Template, Add to Project

- Layout
- Component location
- Z-positionning
- Components info

## The entire structure of a PCB-embedded converter is described in the eCAD tool

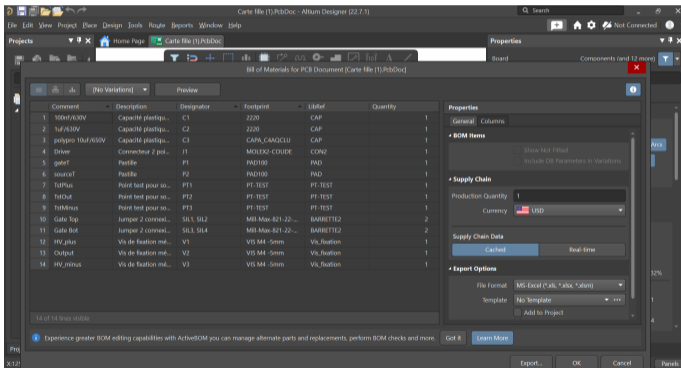

Comment	Description	Designator	Footprint	Libref	Quantity
1	100nF/630V	C1	2220	CAP	1
2	1uF/630V	C2	2220	CAP	1
3	polypro 10uF/630V	C3	CAPA_CAOCLU	CAP	1
4	Driver	Connecteur 2 poi...	J1	MOLEX2-COULDE	CON2
5	gateT	Passif	P1	PAD100	PAD
6	sourceT	Passif	P2	PAD100	PAD
7	TdPlus	Point test pour so...	PT1	PT-TEST	PT-TEST
8	TdOut	Point test pour so...	PT2	PT-TEST	PT-TEST
9	TdMinus	Point test pour so...	PT3	PT-TEST	PT-TEST
10	Gate Top	Jumpers 2 connec...	SIL3, SIL2	MIL-Max-821-22-...	BARBETTE2
11	Gate Bot	Jumpers 2 connec...	SIL3, SIL4	MIL-Max-821-22-...	BARBETTE2
12	HV_plus	Vis de fixation mé...	V1	VIS M4 -5mm	Vis_fixation
13	Output	Vis de fixation mé...	V2	VIS M4 -5mm	Vis_fixation
14	HV_minus	Vis de fixation mé...	V3	VIS M4 -5mm	Vis_fixation

- Layout
- Component location
- Z-positionning
- Components info
- And much more: schematic, materials...



## The entire structure of a PCB-embedded converter is described in the eCAD tool

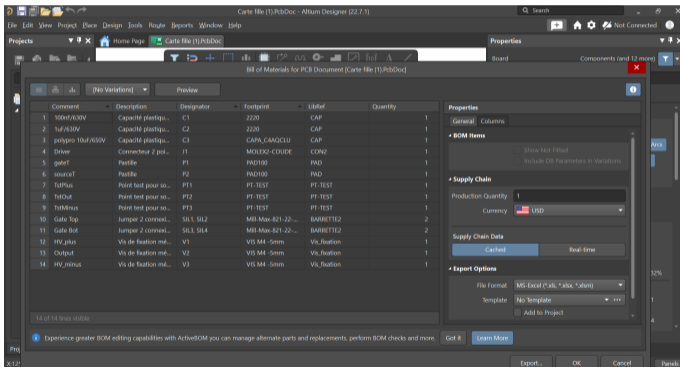

Comment	Description	Designator	Footprint	Libref	Quantity	
1	100nF/630V	C1	2220	CAP	1	
2	1uF/630V	C2	2220	CAP	1	
3	polypro 10uF/630V	C3	CAPA_CAAQCLU	CAP	1	
4	Driver	Connecteur 2 poi...	J1	MOLEX2-COULDE	CON2	1
5	gateT	P1	PAD100	PAD	1	
6	sourceT	P2	PAD100	PAD	1	
7	TdPlus	Point test pour so...	PT-TEST	PT-TEST	1	
8	TdOut	Point test pour so...	PT-TEST	PT-TEST	1	
9	TdMinus	Point test pour so...	PT-TEST	PT-TEST	1	
10	Gate Top	Jumpor 2 connec...	SIL3, SIL2	MIL-Max-821-22-...	BARBETTE2	2
11	Gate Bot	Jumpor 2 connec...	SIL3, SIL4	MIL-Max-821-22-...	BARBETTE2	2
12	HV_plus	Vis de fixation mé...	V1	VIS M4 -5mm	Vis_foitation	1
13	Output	Vis de fixation mé...	V2	VIS M4 -5mm	Vis_foitation	1
14	HV_minus	Vis de fixation mé...	V3	VIS M4 -5mm	Vis_foitation	1

- Layout
- Component location
- Z-positionning
- Components info
- And much more: schematic, materials...

Can we generate a virtual prototype from that description?

# Objectives of the study



**To demonstrate systematic generation of electric and thermal models from eCAD**

- Does the eCAD really contain all needed data? can they be exported?

# Objectives of the study



## **To demonstrate systematic generation of electric and thermal models from eCAD**

- Does the eCAD really contain all needed data? can they be exported?
- Are manual adjustments needed somewhere?

## To demonstrate systematic generation of electric and thermal models from eCAD

- Does the eCAD really contain all needed data? can they be exported?
- Are manual adjustments needed somewhere?
- Are the generated models actually usable?  
(and if not, can automatic model simplification be implemented?)

# Selection of commercial software

- eCAD: Altium
  - Already in use in our team

PCB Layout  
(Altium Designer)

eCAD

## Finite element simulation

Thermal simulation  
(Ansys icepak)

Circuit parasitics  
calculation (Q3D)

## Circuit simulation

Time-domain simulation  
(LTSpice)

# Selection of commercial software

- eCAD: Altium
  - Already in use in our team
- Modelling of circuit parasitics: Ansys Q3D Extractor
  - Already in use in our team
  - Can directly generate SPICE models of multiport layout

PCB Layout  
(Altium Designer)

eCAD

Finite element  
simulation

Thermal simulation  
(Ansys icepak)

Circuit parasitics  
calculation (Q3D)

Circuit  
simulation

Time-domain simulation  
(LTSpice)

# Selection of commercial software

- eCAD: Altium
  - Already in use in our team
- Modelling of circuit parasitics: Ansys Q3D Extractor
  - Already in use in our team
  - Can directly generate SPICE models of multiport layout
- Thermal modelling: Ansys Icepak
  - Geometry import similar to that of Q3D
  - Here we only consider heat conduction

PCB Layout  
(Altium Designer)

eCAD

Finite element  
simulation

Thermal simulation  
(Ansys icepak)

Circuit parasitics  
calculation (Q3D)

Circuit  
simulation

Time-domain simulation  
(LTSpice)

# Selection of commercial software

- eCAD: Altium
  - Already in use in our team
- Modelling of circuit parasitics: Ansys Q3D Extractor
  - Already in use in our team
  - Can directly generate SPICE models of multiport layout
- Thermal modelling: Ansys Icepak
  - Geometry import similar to that of Q3D
  - Here we only consider heat conduction
- Circuit simulation: LTSpice (and PSIM)

PCB Layout  
(Altium Designer)

eCAD

Finite element  
simulation

Thermal simulation  
(Ansys icepak)

Circuit parasitics  
calculation (Q3D)

Circuit  
simulation

Time-domain simulation  
(LTSpice)



# Selection of commercial software

- eCAD: Altium
  - Already in use in our team
- Modelling of circuit parasitics: Ansys Q3D Extractor
  - Already in use in our team
  - Can directly generate SPICE models of multiport layout
- Thermal modelling: Ansys Icepak
  - Geometry import similar to that of Q3D
  - Here we only consider heat conduction
- Circuit simulation: LTSpice (and PSIM)
  - Models available for many power devices

PCB Layout  
(Altium Designer)

eCAD

Finite element  
simulation

Thermal simulation  
(Ansys icepak)

Circuit parasitics  
calculation (Q3D)

Circuit  
simulation

Time-domain simulation  
(LTSpice)

# Selection of commercial software

- eCAD: Altium
  - Already in use in our team
- Modelling of circuit parasitics: Ansys Q3D Extractor
  - Already in use in our team
  - Can directly generate SPICE models of multiport layout
- Thermal modelling: Ansys Icepak
  - Geometry import similar to that of Q3D
  - Here we only consider heat conduction
- Circuit simulation: LTSpice (and PSIM)
  - Models available for many power devices
  - Free to use

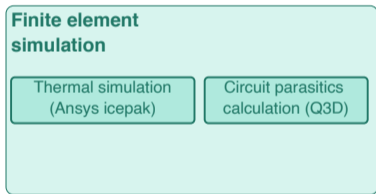
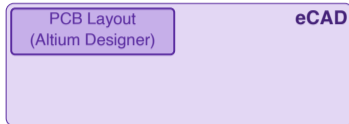

# Selection of commercial software

- eCAD: Altium
  - Already in use in our team
- Modelling of circuit parasitics: Ansys Q3D Extractor
  - Already in use in our team
  - Can directly generate SPICE models of multiport layout
- Thermal modelling: Ansys Icepak
  - Geometry import similar to that of Q3D
  - Here we only consider heat conduction
- Circuit simulation: LTSpice (and PSIM)
  - Models available for many power devices
  - Free to use
  - Probably not so powerful

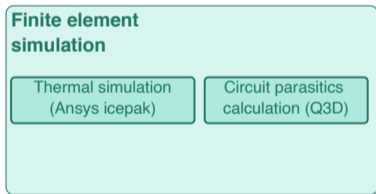
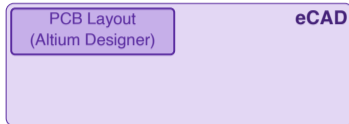

# Outline

- 1 Current design tools for power electronics
- 2 Proposition for PCB-embedded electronics
- 3 Export from eCAD**
- 4 Electrical model
- 5 Thermal model
- 6 Conclusion

# File formats – [2]

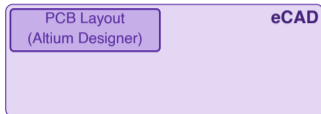

## Finite element simulation

Thermal simulation  
(Ansys icepak)

Circuit parasitics  
calculation (Q3D)

## Circuit simulation

Time-domain simulation  
(LTSpice)

Many file format available for export;

# File formats – [2]

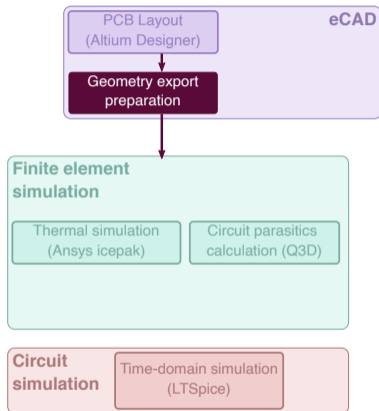

Many file format available for export;

In practice, when imported in Ansys:

	Gerber	ODB++	IPC-2581	<b>EDB</b>
3D-model	--	-	-	<b>++</b>
Layout details (materials,Nets)	--	-	+	<b>++</b>
Components details	--	-	+	<b>++</b>

# 3D Model construction – [2]

## 1 Geometry import

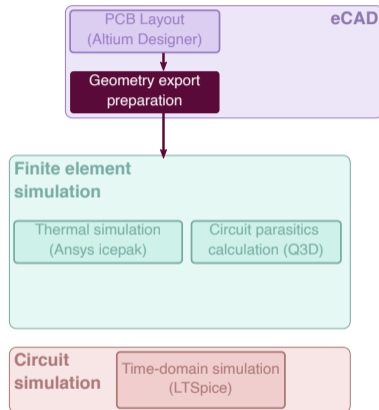

# 3D Model construction – [2]

- 1 Geometry import
- 2 Reconstruction of embedded chips  
(not properly exported)

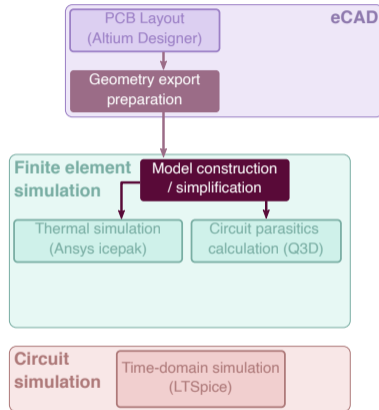



# 3D Model construction – [2]

- 1 Geometry import
- 2 Reconstruction of embedded chips (not properly exported)
- 3 Simplification of the geometry
  - Faceting of round shapes (feature of Ansys)
  - Grouping of vias (custom routine)

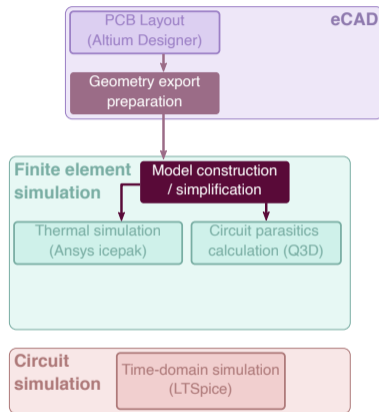
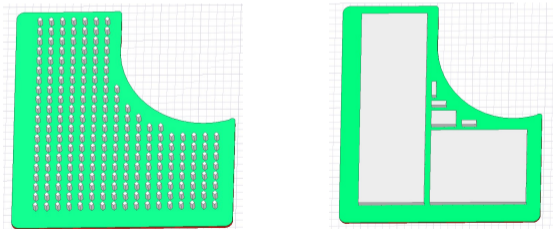

# 3D Model construction – [2]

- 1 Geometry import
- 2 Reconstruction of embedded chips (not properly exported)
- 3 Simplification of the geometry
  - Faceting of round shapes (feature of Ansys)
  - Grouping of vias (custom routine)

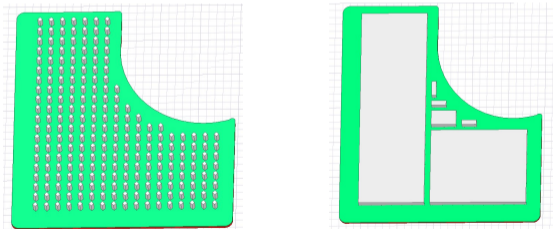

- 4 Further simulation-dependent pre-processing

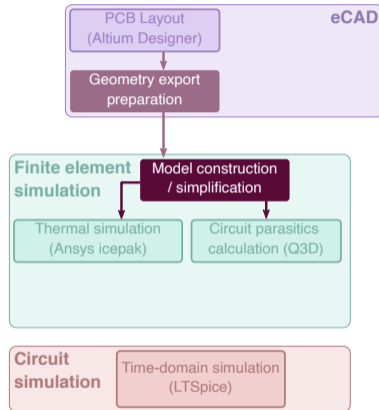

# Outline

- 1 Current design tools for power electronics
- 2 Proposition for PCB-embedded electronics
- 3 Export from eCAD
- 4 Electrical model**
- 5 Thermal model
- 6 Conclusion

# Computation of circuit parasitics



- Pre-processing:

# Computation of circuit parasitics

- Pre-processing:
  - Merge pads when too close (model simplification)

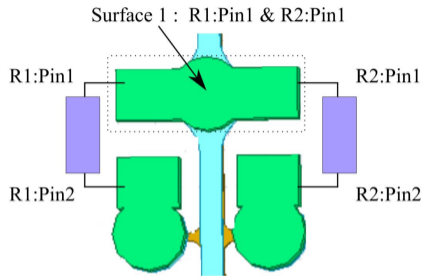

# Computation of circuit parasitics

- Pre-processing:
  - Merge pads when too close (model simplification)
  - Create contact points on large surfaces

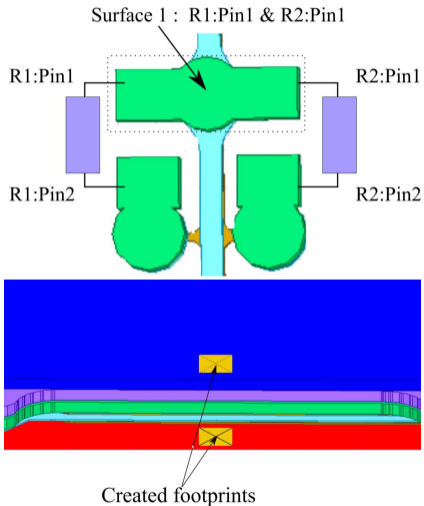

# Computation of circuit parasitics

- Pre-processing:
  - Merge pads when too close (model simplification)
  - Create contact points on large surfaces
  - **Automatically place terminals for computation** (“sinks” and “source” in Q3D)

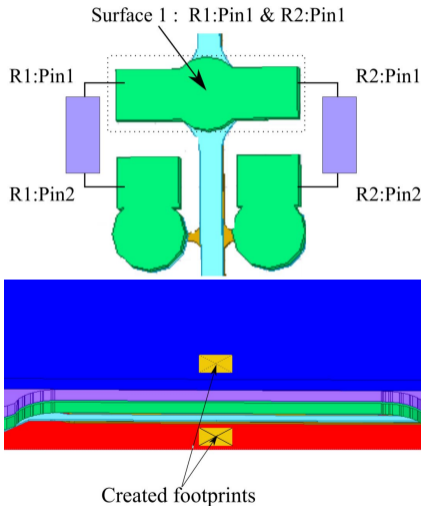

# Computation of circuit parasitics

- Pre-processing:
  - Merge pads when too close (model simplification)
  - Create contact points on large surfaces
  - **Automatically place terminals for computation** (“sinks” and “source” in Q3D)
- Run calculation of stray R, L, C between all terminals

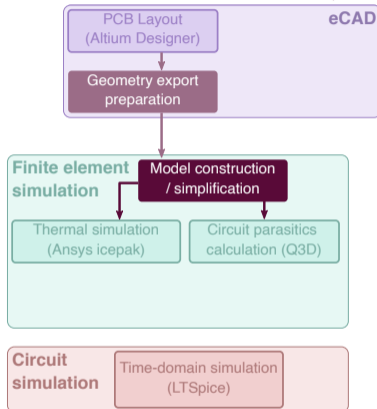



# Computation of circuit parasitics

- Pre-processing:
  - Merge pads when too close (model simplification)
  - Create contact points on large surfaces
  - **Automatically place terminals for computation** (“sinks” and “source” in Q3D)
- Run calculation of stray R, L, C between all terminals
- Generate a SPICE model (Q3D feature)

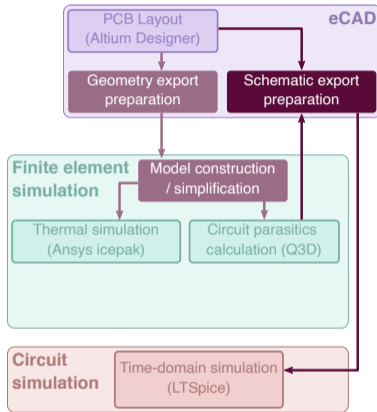

# Computation of circuit parasitics

- Pre-processing:
  - Merge pads when too close (model simplification)
  - Create contact points on large surfaces
  - **Automatically place terminals for computation** (“sinks” and “source” in Q3D)
- Run calculation of stray R, L, C between all terminals
- Generate a SPICE model (Q3D feature)
- Return model and list of terminals to eCAD

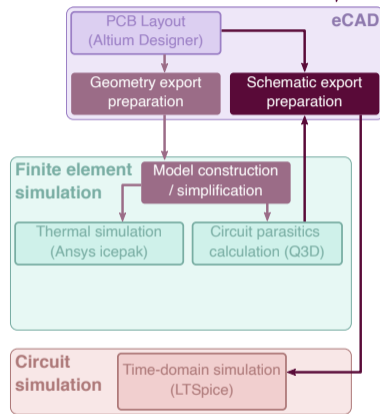

# Computation of circuit parasitics

- Pre-processing:
  - Merge pads when too close (model simplification)
  - Create contact points on large surfaces
  - **Automatically place terminals for computation** (“sinks” and “source” in Q3D)
- Run calculation of stray R, L, C between all terminals
- Generate a SPICE model (Q3D feature)
- Return model and list of terminals to eCAD
- Generate LTSpice schematic

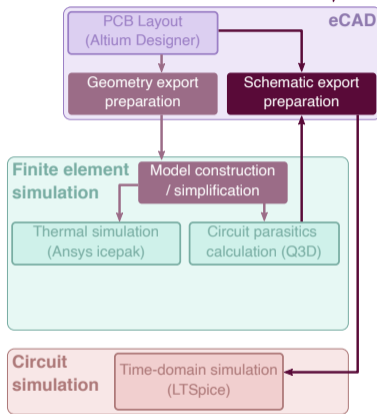

# Circuit schematics



## Altium (eCAD) Power stage

Decoupling capacitor

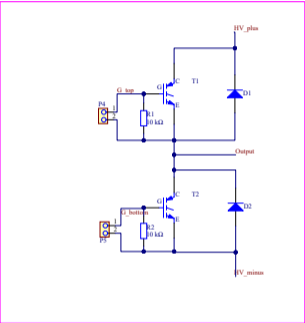
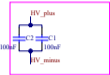

## LTSpice (circuit simulation)

# Circuit schematics

## Altium (eCAD)

Power stage

Decoupling capacitor

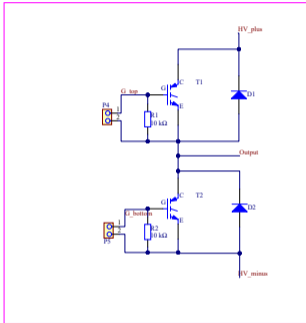
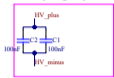

- Reproduce location of symbols
- Layout model as a single block
- Connections generated automatically

## LTSpice (circuit simulation)

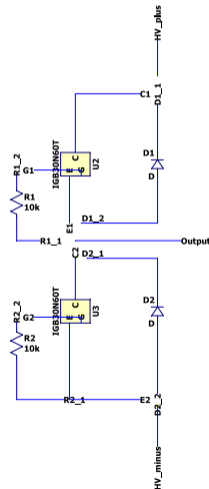
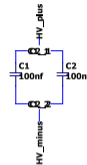

U1		
C1_1	1	11 C1_2
C2_1	2	12 C2_2
D1_1	3	13 D1_2
D2_1	4	14 D2_2
E1	5	15 E1
E2	6	16 E2
G1	7	17 HV_plus
G2	8	18 Output
R1_1	9	19 HV_minus
R1_2	10	20 G1
R2_1		21 R2_2

Half\_bridge\_Q3D

# Experimental validation – Layout Impedance

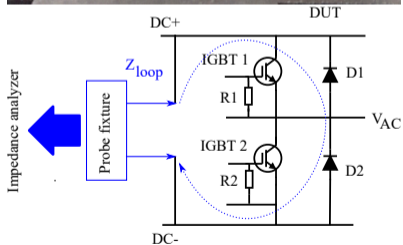
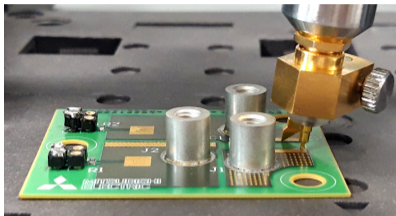

Impedance measurement

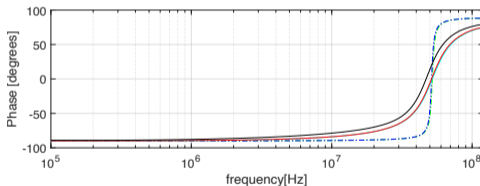
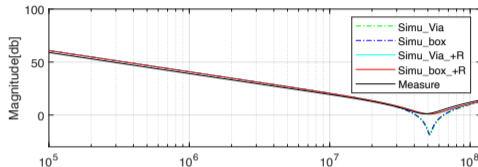

- No negative effect of via simplification
- Measurement accuracy limited (2-wire, contact probe...)
- Good simulation/experiment agreement overall

# Experimental validation – Double-pulse test

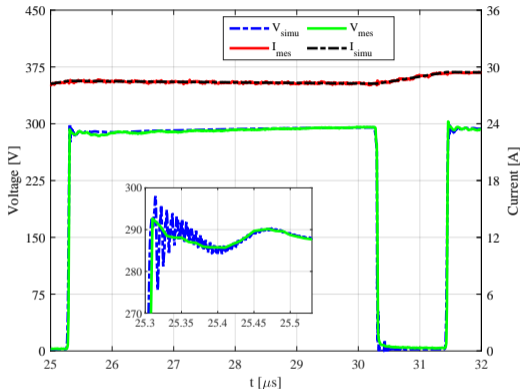
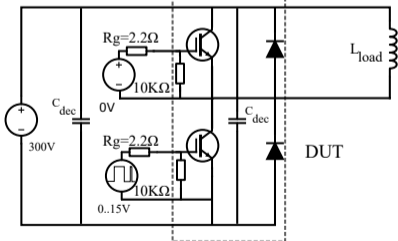
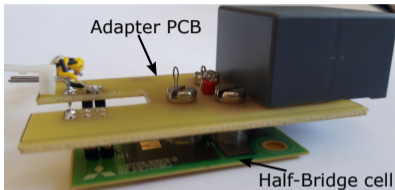

- Proof of concept for systematic model generation
  - No manual modification of Half Bridge PCB model
- No LTSpice model available for used IGBTs and diodes

# Outline

- 1 Current design tools for power electronics
- 2 Proposition for PCB-embedded electronics
- 3 Export from eCAD
- 4 Electrical model
- 5 Thermal model**
- 6 Conclusion



# Generation of a thermal model

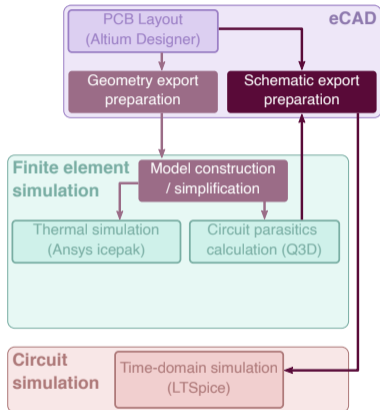

## Starting from imported geometry:

### 1 Define heat sources

- Manual selection of the components to be considered in the eCAD export stage

# Generation of a thermal model

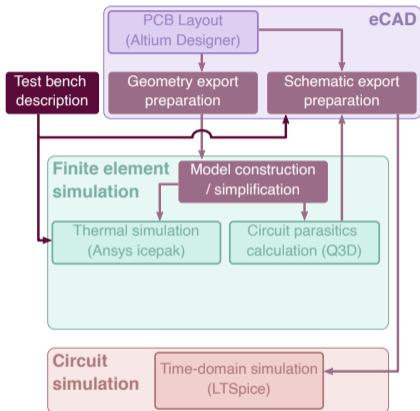

## Starting from imported geometry:

- 1 Define heat sources
  - Manual selection of the components to be considered in the eCAD export stage
- 2 Application of boundary conditions
  - Not implemented yet for electrical simulations
  - Approach similar to that of the VHDL “test benches”

# Generation of a thermal model

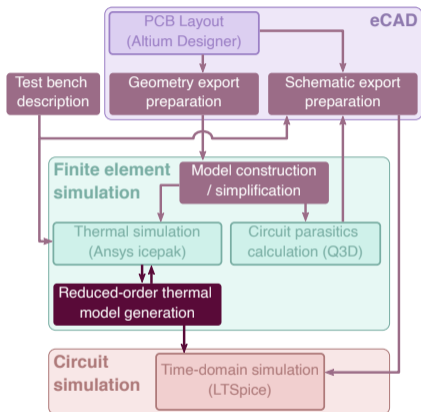

## Starting from imported geometry:

- 1 Define heat sources
  - Manual selection of the components to be considered in the eCAD export stage
- 2 Application of boundary conditions
  - Not implemented yet for electrical simulations
  - Approach similar to that of the VHDL “test benches”
- 3 Reduced-order thermal model generation
  - Sequentially “activate” each power source
  - Perform a FEM simulation (Ansys Icepak)
  - Export transient temp. rise of each component
  - Identify  $R_{Th}C_{Th}$  models and generate Spice Netlist

# Geometry simplification – Description [3]

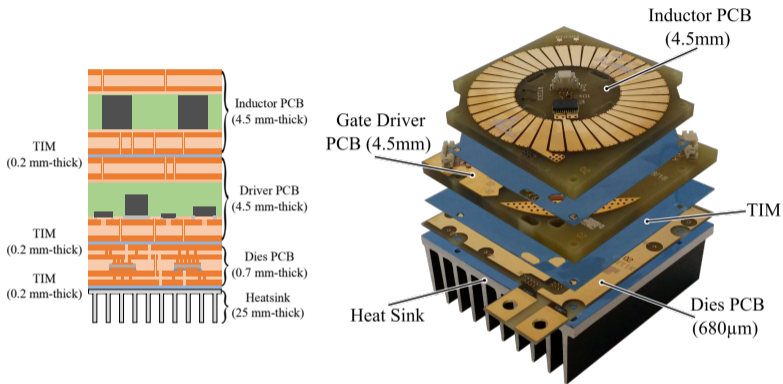

**Two approaches investigated:**

# Geometry simplification – Description [3]

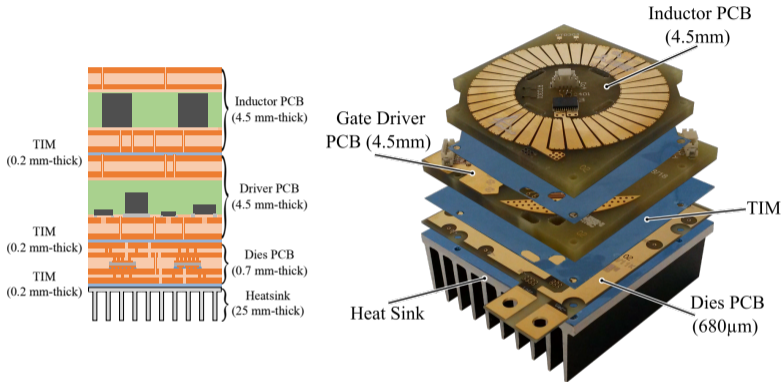

Full detail model

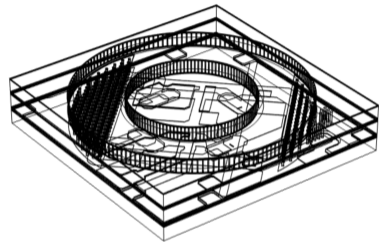

## Two approaches investigated:

- No simplification (inc. vias)

# Geometry simplification – Description [3]

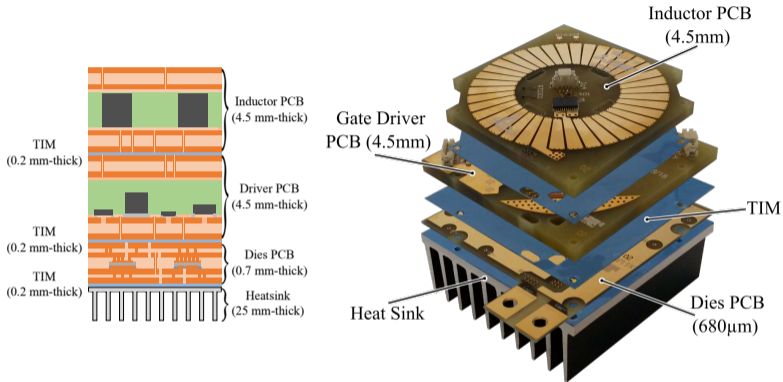

Full detail model

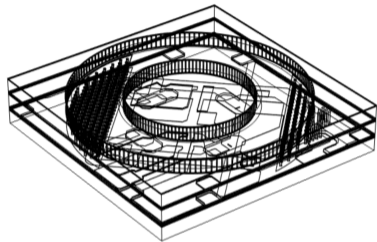

Simplified model

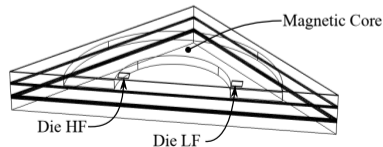

## Two approaches investigated:

- No simplification (inc. vias)
- “Layer-based Homogenization” (uniform conductivity on each layer)

# Geometry Simplification – Results [3]

Simulations performed with Comsol

## Full detail model:

- 1.5 M elements
- thinnest tracks had to be removed

## Simplified model:

- 0.3 M elements
- Anisotropic conductivity for
  - via-filled areas
  - Cu layers with low copper filling

Validation of simulation results with experiments

RTD location	Exp.	Simplified	Full
HF Die RTD	37 °C	35 °C	38 °C
LF Die RTD	34 °C	34 °C	34 °C
Outer Ind. RTD	27 °C	32 °C	31 °C
Inner Ind. RTD	30 °C	33 °C	31 °C

( $\Delta T$  with ambient temperature for embedded sensors)

# Outline

- 1 Current design tools for power electronics
- 2 Proposition for PCB-embedded electronics
- 3 Export from eCAD
- 4 Electrical model
- 5 Thermal model
- 6 Conclusion**



# Conclusion

## Progress so far

- Electrical model:
  - Full workflow demonstrated on simple circuit (half bridge)
  - “Test bench” to be implemented
    - automatic connection of input/outputs
    - modeling of external metal planes (such as heatsinks)
  - Validation to be performed on more complex boards
- Thermal model:
  - eCAD export / FEM import done (inc. selection of relevant components)
  - Currently working Zth calculations and reduced RC model generation

# So, what about our objectives?

## To demonstrate systematic generation of electric and thermal models from eCAD

- *Does the eCAD really contain all needed data? can they be exported?*
  - ✓ Export is possible with minimum losses
  - ✓ Special scripts required in addition to EDB export
  - ✗ Interface with outside world not included in eCAD

# So, what about our objectives?

## To demonstrate systematic generation of electric and thermal models from eCAD

- *Does the eCAD really contain all needed data? can they be exported?*
  - ✓ Export is possible with minimum losses
  - ✓ Special scripts required in addition to EDB export
  - ✗ Interface with outside world not included in eCAD
- *Are manual adjustments needed somewhere?*
  - ✓ No manual adaptation of the models required so far
  - ✓ Manual selection of components to be considered for thermal analysis

# So, what about our objectives?

## To demonstrate systematic generation of electric and thermal models from eCAD

- *Does the eCAD really contain all needed data? can they be exported?*
  - ✓ Export is possible with minimum losses
  - ✓ Special scripts required in addition to EDB export
  - ✗ Interface with outside world not included in eCAD
- *Are manual adjustments needed somewhere?*
  - ✓ No manual adaptation of the models required so far
  - ✓ Manual selection of components to be considered for thermal analysis
- *Are the generated models actually usable?*
  - ✓ Simplification required for vias (but can be done automatically)
  - ? Test on larger circuits will show if this approach works

- [1] T. Lagier, P. Dworakowski, L. Chédot, F. Wallart, B. Lefebvre, J. Maneiro, J. Páez, p. Iadoux, and C. Buttay, “How Good are the Design Tools in Power Electronics?,” in *EPE’20 ECCE Europe*, (Lyon (Virtual conference), France), Sept. 2020.
- [2] B. Ben Hamed, G. Regnat, G. Lefèvre, and C. Buttay, “Automatic Model Generation for PCB-based Power Electronics,” in *Conference on Integrated Power Electronics Systems (CIPS)*, (Berlin, Germany), Mar. 2022.
- [3] R. Caillaud, C. Buttay, R. Mrad, J. Le Lesle, F. Morel, N. Degrenne, and S. Mollov, “Thermal Considerations of a Power Converter with Components Embedded in Printed Circuit Boards,” *IEEE Transactions on Components, Packaging and Manufacturing Technology*, 2019.

# Thanks for your attention

This work has been supported by Mitsubishi Electric R&D Centre Europe

[cyril.buttay@insa-lyon.fr](mailto:cyril.buttay@insa-lyon.fr)



Université Claude Bernard



Lyon 1

