



**HAL**  
open science

## Mode I delamination R-Curve in poplar laminated veneer lumber

Axel Peignon, Joël Serra, L. Gélard, Arthur Cantarel, Florent Eyma, B. Castanié

► **To cite this version:**

Axel Peignon, Joël Serra, L. Gélard, Arthur Cantarel, Florent Eyma, et al.. Mode I delamination R-Curve in poplar laminated veneer lumber. Theoretical and Applied Fracture Mechanics, 2023, 10.1016/j.tafmec.2023.103982 . hal-04141431v2

**HAL Id: hal-04141431**

**<https://hal.science/hal-04141431v2>**

Submitted on 25 Aug 2023

**HAL** is a multi-disciplinary open access archive for the deposit and dissemination of scientific research documents, whether they are published or not. The documents may come from teaching and research institutions in France or abroad, or from public or private research centers.

L'archive ouverte pluridisciplinaire **HAL**, est destinée au dépôt et à la diffusion de documents scientifiques de niveau recherche, publiés ou non, émanant des établissements d'enseignement et de recherche français ou étrangers, des laboratoires publics ou privés.

# 1                                    **Mode I delamination R-Curve in poplar laminated veneer lumber**

2    A. Peignon<sup>1</sup>, J. Serra<sup>1</sup>, L. Gélard<sup>1</sup>, A. Cantarel<sup>1</sup>, F. Eyma<sup>1</sup> and B. Castanié<sup>1,\*</sup>

3    <sup>1</sup> Institut Clément (ICA), Université de Toulouse, CNRS UMR 5312, INSA, ISAE-Supaéro, INSA,  
4    IMT Mines Albi, UPS, Toulouse, France

5    \*corresponding author: [bruno.castanie@insa-toulouse.fr](mailto:bruno.castanie@insa-toulouse.fr)

6    **Abstract:** Recent studies have shown that plywood and laminated veneer lumber are very efficient  
7    crashworthiness materials. Therefore, there is a need to determine the fracture toughness of these  
8    wood composite materials to be able to model their static and dynamic damage behavior. This study  
9    reports the results of the delamination propagation of plywood under mode I loading. Two different  
10    double cantilever beam specimens made of poplar were compared: one with an interfacial fiber  
11    orientation of 0°/0° and the second with 0°/90°. Failure scenarios and patterns are analyzed to  
12    establish a comparison between the two configurations and compute consistent R-curves.

13    **Keywords:** Wood veneers, R-curve, Double Cantilever Beam (DCB), Delamination, Fiber bridging,  
14    Laminated veneer lumber (LVL)

15    **Funding:** This work was supported by the French National Research Agency under the BOOST  
16    project (ANR-21-CE43-0008-01).

---

CC: Compliance Calibration  
DCB: Double Cantilever Beam  
IR: InfraRed  
LVL: Laminated Veneer Lumber  
MBT: Modified Beam Theory  
MCC: Modified Compliance Calibration  
RSD: Relative Standard Deviation  
SEA: Specific Energy Absorption  
SD: Standard Deviation

17 **Nomenclature**

a	crack length
$a_0$	initial crack length
b	specimen width
C	specimen compliance
$E_L$	modulus of elasticity of wood along the longitudinal direction
$G_{Ic}$	fracture toughness in mode I
h	specimen height
I	moment of inertia of a DCB specimen arm
L	veneer longitudinal direction
$L'$	half width of loading block
l	specimen length
P	load acting on the specimen
R	veneer Radial direction
T	veneer Tangential direction
t	distance from loading block pin to center line of top specimen arm
X	specimen length direction
$x_0$	x coordinate of the crack origin
$x_1$	x coordinate of point 1
$x_f$	x coordinate of crack tip
Y	specimen depth direction
$y_0$	y coordinate of crack origin
$y_1$	y coordinate of point 1
$y_f$	y coordinate of crack tip
Z	specimen thickness direction
$\delta$	applied displacement
$\lambda_i$	i-th coefficient of an unknown function

18

## 19 **1. Introduction**

20 Wood is one of the earliest materials used by man in construction [1]. It is a well-known material for  
21 which there exists fairly detailed knowledge of its pathologies and durability characteristics. One of  
22 the first building codes concerned wood as the material and was published in 1091 in China [2].

23 Wood, especially used in sandwich structures, was also one of the materials used in aeronautics in its  
24 early days and until the Second World War [3]. In addition, it is a natural and renewable material,  
25 which can be produced locally and recycled [4], [5]. It also acts as a carbon sink, a natural reservoir  
26 capable of absorbing and storing carbon from atmospheric CO<sub>2</sub>. Wood can therefore play a key role in  
27 the fight against global warming [6]. Its waste products are also reusable as a secondary material or  
28 energy source [7] and structural material [8].

29 Laminated veneer lumber (LVL) and plywood are structural composite products made from thin,  
30 peeled wood plies, called veneers, assembled with an adhesive. Plywood has cross-lamination, which  
31 means that longitudinal and transverse veneers are alternated throughout the laminate [9]. Because of  
32 their manufacturing steps, LVL and plywood offer the possibility of selecting veneers without visible  
33 defects such as knots, knotholes or cracks and have static mechanical characteristics comparable to, or  
34 even superior to, those of solid wood [10]–[13]. In addition, recent studies by the authors have shown  
35 that LVL also has interesting mechanical potential for crash or impact applications [14]–[18]. For  
36 example, Guélou et al. [14] obtained a dynamic Specific Energy Absorption (SEA) for birch wood  
37 ranging between 35.7 J/g and 41.1 J/g. The SEA refers to the amount of energy per gram that a  
38 material can absorb before it fails or breaks. In addition, sandwich structures with plywood cores and  
39 composite (glass, carbon, linen) or metal (aluminium) skins [19], have shown very good resistance to  
40 low-speed/low-energy impact [20] as well as excellent post-impact compressive strength in  
41 configurations with aluminium skin and linen, where the knockdown factor is less than 10% [15].

42 However, a previous study simulated impact on wood based materials with a damage law available in  
43 LS-Dyna [21]. This study showed a deficiency of this type of approach. Additionally, based on their  
44 experience of the impact on composite structures [22]–[25] the authors believe that the use of the so-  
45 called Discrete Ply Model [23]–[25] modeling strategy would be relevant to model the fracture

46 scenarios of plywood-based structures, in both static and dynamic situations. This strategy is based on  
47 only 13 parameters, including energy fracture toughness at interfaces, which should be identified  
48 specifically for wood applications.

49 To characterize the glue joint, the standard NF EN 302 (AFNOR 2017) or the former standard DIN  
50 53253 (DIN 1964) propose to test the shear strength of the glue joint via longitudinal tensile tests.  
51 However, during this type of test, only the strength of the glue line is characterized [26]. Thus,  
52 synthetic composite materials standard ASTM D5528 (ASTM 2010) is considered to characterize the  
53 toughness of a glued interface in mode I. This opening mode is studied as a priority because, in  
54 general among the three modes of propagation of a crack, it is the one that requires the least energy  
55 and is therefore the most dangerous for the structure. The mode I toughness of the LVL is generally  
56 characterized by a DCB (Double Cantilever Beam) test. This test makes it possible to obtain the  
57 Resistance curve of the characterized interface, also called the R-curve. This curve represents the  
58 amount of energy required to propagate an initial crack in the interface to be characterized [27]. The  
59 few authors who have shown interest in DCB tests on glued wood interfaces, either for LVL or  
60 plywood include El Moustaphaoui et al. [28], [29], who characterized the toughness of a 9-ply ceiba  
61 plywood interface, without specifying its stacking sequence, using urea-formaldehyde glue. They  
62 obtained a  $G_{Ic}$  value between 140 J/m<sup>2</sup> and 200 J/m<sup>2</sup>. Baba et al. [30] were interested in the  
63 delamination of beech plywood with a 0°/0° interface and the stacking sequence [0°/90°/0°]<sub>s</sub>. They  
64 obtained a  $G_{Ic}$  value of the order of 20 J/m<sup>2</sup>. This value, which is low compared to that of El  
65 Moustaphaoui, can be explained by the addition of rye flour in the urea-formaldehyde glue used to  
66 make the test tubes. Other authors have been interested in glued wood interfaces in glulam [31]–[37].  
67 The order of magnitude of  $G_{Ic}$  values obtained by these studies is a few hundred Joules per square  
68 meters.

69 Previous studies only considered 0°/0° delamination interfaces [28]–[37] but, in the case of laminates  
70 such as plywood, delamination occurs mainly at 0°/90° interfaces because interlaminar shear is  
71 maximum for perpendicularly oriented interfaces. This phenomenon is well known in the field of  
72 composites [38] but not studied for wood.

73 In the case of laminates made of synthetic composite materials, the configuration with a 0°/0° interface  
74 makes it possible to find a lower bound for the value of  $G_{Ic}$  by limiting fiber bridging while keeping  
75 the crack in the interface between the 0°/0° plies. The configuration with a 0°/90° interface is more  
76 likely to create migration of the crack into the 90° ply and therefore will tend to overestimate the  $G_{Ic}$   
77 [39], [40].

78 Moreover, in the case of LVL or plywood, only El Moustaphaoui et al. have computed R-curves [28].  
79 Baba et al. have reproduced an R-curve characterizing the  $G_{Ic}$  of initiation for various initial cracks  
80 [30]. However, once the R-curve is obtained, few physical justifications are provided to explain its  
81 evolution and analyze these specimens' fracture surfaces.

82 Therefore, the study presented here aims to provide mode I delamination R-curves for two different  
83 interfaces: a 0°/0° interface and a 0°/90° interface. The evolution of the R-curve will be analyzed for  
84 Koster poplar (*Populus*) plywood and a comparison will be made between the two interfaces studied.  
85 The corresponding fracture toughness will be calculated and analyzed.

## 86 **2. Materials and Experimental Procedures**

87 The Double Cantilever Beam (DCB) test consists of applying a load to the ends of the specimen,  
88 which causes the crack to propagate in pure mode I. The specimen is placed with an initial crack  
89 length ( $a_0$ ). Figure 1 shows the DCB test and the depiction of the initial crack. The fracture energy can  
90 be evaluated using the force-displacement curve (P- $\delta$  curve), the crack length ( $a$ ), and the Irwin-Kies  
91 equation [41] (Equation 1):

$$92 \quad G_{Ic} = \frac{P^2}{2b} \frac{dC}{da}$$

93 **Equation 1**

94 with  $b$  as the width of the specimen and  $C$  as the compliance of the specimen (Equation 2).

$$95 \quad C = \frac{\delta}{P}$$

96 **Equation 2**

### 97 **2.1. Materials and Manufacturing**

98 One-millimeter Koster wood veneers were used in the manufacture of the DCB test specimens. The  
99 veneer, supplied by the LaBoMaP laboratory in Cluny, France, was produced using a rotary wood  
100 peeling machine. The moisture content of the wood was measured at 10.1% with a Relative Standard  
101 Deviation (RSD) of 0.4%. The veneers were then stacked and pressed for 5 hours at 10 bars and 25°C.  
102 The wood glue used to make the plywood was Kleiberit PUR 510 FIBERBOND, a one-component  
103 polyurethane-based glue that hardens by reaction with moisture. The amount of glue used was 250  
104 g/m<sup>2</sup>. The density of Koster veneers was 348 kg/m<sup>3</sup> (RSD: 4%).

105 Two specimen configurations were made for this study and are illustrated in Figure 2:

- 106 • 8-ply laminates with a  $[0^\circ]_8$  stacking sequence to study the  $0^\circ/0^\circ$  interface, referred to as “ $0^\circ/0^\circ$   
107 specimens”.
- 108 • 9-ply laminates with a  $[0^\circ_4, 90^\circ, 0^\circ_4]$  stacking sequence to study the  $0^\circ/90^\circ$  interface, referred to  
109 as “ $0^\circ/90^\circ$  specimens”. A view of the thickness is shown in Figure 3.

110 Two reference frames will be used to describe the systems (Figure 3):

- 111 • A global reference frame (X,Y,Z) with X oriented along the length of the DCB specimen, Y in  
112 its depth, and Z in its thickness (Figure 1).
- 113 • A local reference frame (L,T,R), describing the main directions of the wood, is used to  
114 characterize the veneers (L oriented in the direction of the wood fibers (the wood cells), R  
115 oriented in the direction of the growth rings, and so in the thickness of the veneers, and T in the  
116 transverse direction in the plane of the veneers).

117 It is important to note that, during the manufacture of veneers, lathe checks are created on one of their  
118 faces [42], [43]. Lathe checks are small cracks (~0.1mm in the veneer used for this study) that occur  
119 along the length of the veneer layers in plywood (Figure 4). These cracks happen when the veneer is  
120 manufactured (Figure 5). In addition, the thickness of a wood veneer can be composed of earlywood  
121 (wood formed at the beginning of the growing season) and latewood (wood formed later in the  
122 season) [44] (Figure 5). It is important to note that the anatomy and the mechanical properties of those  
123 two kinds of wood are different [45]–[47].

124 Moreover, unlike carbon composite materials, in wood, and so veneers, not all wood fibers are  
125 perfectly aligned, they may have an in-plane and an out-of-plane angle. This is due to the wood nature  
126 and, for veneers, the manufacturing process. Since the out-of-plane angle is mainly due to the  
127 irregularity of the wood log, when the veneer is peeled, the fibers in the LR plane of the veneer are not  
128 aligned with the L direction (Figure 6).

129 The plywood manufactured for the DCB specimen considers the positions of the lathe checks present  
130 in the Koster veneer. During stacking, faces with lathe checks are placed on healthy faces, except for  
131 the outer plies, where the cracked faces face the inside of the plywood. This stack is called “tight side  
132 out and loose side in” and it is this setup that is used in industry for the manufacture of plywood [48].  
133 Figure 7 illustrates the stack used for  $0^\circ/0^\circ$  specimens.

134 For the  $0^\circ/90^\circ$  interfacial orientation, it was therefore decided to orient the cracked face of the  $0^\circ$  ply  
135 towards the inside of the interface. Figure 8 illustrates the location of the lathe checks at the  $0^\circ/90^\circ$   
136 interface in the XZ and YZ planes.

137 A total of 12 specimens per configuration were laser cut. DCB specimens had nominal dimensions of  
138  $250(l)\times 25(b)\times 8(h)$  mm<sup>3</sup> for the  $0^\circ/0^\circ$  series and  $250(l)\times 25(b)\times 9(h)$  mm<sup>3</sup> for the  $0^\circ/90^\circ$  series (shown in  
139 Figure 9). Attachment blocks were chosen to attach the DCB specimens to the tension machine. The  
140 initial notch ( $a_0$ ) was made in two stages: a Teflon film was placed during the production of the  
141 plywood (as recommended by ASTM D5528 (ASTM 2010)), and then the crack was initiated using a  
142 thin cutter blade. The insertion of the cutter blade made it possible to spread the arms slightly so that  
143 cracking was initiated without damaging the crack tip. The initiation made with the cutter reduced the  
144 variability related to a possible glue cluster at the end of the Teflon film.

## 145 **2.2. Experimental Setup**

146 DCB tests were performed at ambient temperature and humidity (23.5°C (SD: 0.5°C) and 47% H (SD:  
147 2% H)). An Instron 5900 machine was used to perform the tests using a displacement control (Figure  
148 10). A 50 kN force cell was installed, with a measurement accuracy of 0.5 N, and the travel speed was  
149 set at 20 mm/min.



150 Digital Image Correlation (DIC) was used to track sample deformation. A 5 MP camera (2452x2052  
151 pixels) was used to acquire images of the specimens during the test. An infrared thermography (IRT)  
152 camera (M3K - Telops) was placed on the other side of the specimens to examine the propagation of  
153 damage during the test. The specimens were painted with matt black paint on one side for the IRT  
154 camera, to have a constant and maximum emissivity, and with speckles on the other side for image  
155 correlation (Figure 10). The speckles were made using spray paint and the size of the patterns was  
156 determined according to the experimental configuration to obtain a minimum size of 3 pixels for each  
157 speckle [49].

158 A data acquisition system was used to record both the applied load (P) and the vertical displacement of  
159 the clamps ( $\delta$ ) (Figure 1), with the acquisition frequency related to image correlation set at 1 Hz.

160 Image correlation data were analyzed with VIC 2D® correlation software. Calibration was carried out  
161 using a calibration pattern. The acquisition frequency of the thermal imaging camera was set at 50 Hz.

### 162 **2.3. Methodology**

163 To compute the fracture energy with a DCB test and the methods presented in ASTM D5528 (ASTM  
164 2010), it is necessary to establish a link between compliance C and crack length to obtain  $dC/da$   
165 (Equation 1). Many models are documented in the literature, the main ones being:

- 166 • Compliance Calibration (CC) ( $C = \lambda_0 a^{\lambda_1}$ ;  $\lambda_0$  and  $\lambda_1$  are constants that need to be identified),  
167 described in ISO 15024 (ISO 2001) and ASTM D5528 (ASTM 2010),
- 168 • Modified Compliance Calibration (MCC) ( $C^{1/3} = \lambda_1 a/h + \lambda_0$ ;  $\lambda_0$  and  $\lambda_1$  are constants that need to  
169 be identified), described in ASTM D5528 (ASTM 2010),
- 170 • Modified Beam Theory (MBT) ( $C = 2a^3/3E_1I$ ) described in ISO 15024 (ISO 2001) and ASTM  
171 D5528 (ASTM 2010).

172 DIC was used to obtain the crack length required in the three methods employed in this paper. To  
173 post-process DIC images, the size of the subset was fixed so that the subset contained 3 to 4 speckles.

174 The confidence interval of the correlation (called "Sigma") was used to visualize the correlation  
175 mismatch and thus estimate the position of the crack tip of the specimens (Figure 11). The Sigma cut-

176 off value chosen was 0.015, which corresponds to the maximum value obtained when calculating the  
177 confidence interval between two identical images. The value obtained corresponded to the noise in the  
178 study area, so values below 0.015 will not be considered hereafter and are, therefore, not related to the  
179 presence of a crack. In addition, the resolution of the camera was 4.55 pixels for 1 mm; so, a  
180 correlation confidence interval of 0.015 pixels corresponds to an interval of 0.0033 mm.

181 A Python script was used to track the crack tip using Sigma visualization obtained for each specimen  
182 over time. Manual point-by-point monitoring was carried out to obtain the coordinates in millimeters  
183 of the tip of the crack at each time.

184 When setting up DIC cameras, a compromise was used to see as many of the samples as possible  
185 while keeping a resolution high enough to allow sufficient resolution of the speckles. Therefore, the  
186 ends of the specimens were not visible during the test. That is why to obtain the crack length, it is  
187 necessary to compute it by using the origin of the crack and consider the bending of the lower arm of  
188 all the specimens during the tensile test. For each image captured, three points were tracked and used  
189 for specimen curvature interpolation. The first point corresponded to the crack tip  $(x_f, y_f)$ , the second  
190 to the origin of the crack  $(x_0, y_0)$ , and the third was taken on the interface of the specimen between the  
191 first and second points  $(x_1, y_1)$ , (Figure 12). A second-order function was used to fit this set of points  
192 (named  $f(x)$ ). Then, the length of the crack was calculated between the origin of the crack and the  
193 crack tip with Equation 3 for each image:

$$194 \quad \mathbf{a} = \int_{x_0}^{x_f} \sqrt{1 + f'(x)^2} dx$$

195 **Equation 3**

196 To validate the method implemented, the measured and calculated lengths of the initial crack were  
197 compared for each specimen. Figure 13 illustrates the difference between these two values for all DCB  
198 specimens. The average deviation of this difference is 0.33 mm. The accuracy of ½ mm recommended  
199 by the ASTM D5528 standard (ASTM 2010) was thus respected.

### 200 **3. Results**

201 Once the tests were completed, each specimen was inspected to remove specimens with "abnormal"  
202 fracture patterns from the study. For example, in some  $0^\circ/0^\circ$  series specimens, the crack migrated into  
203 the plies at the beginning of the test even though it was initially at the interface. Since the force  
204 applied was no longer symmetrical, the crack propagation was no longer in pure mode I and these  
205 DCB tests were, therefore, no longer considered valid. For this reason, four specimens were excluded  
206 from this study. This migration of the crack in the  $0^\circ/0^\circ$  configuration can be explained by the out-of-  
207 the-plane variation of the grain angle in the veneers (Figure 14 and Figure 15), not all wood fibers are  
208 horizontal and they may have an out-of-plane angle. This phenomenon is not common in DCB tests of  
209 composite composites [50]. In addition, as explained in §2.3, the end of the specimen was not visible,  
210 and monitoring the crack-tips coordinates  $(x_f, y_f)$  was no longer possible for the last propagations and  
211 the final fracture, so the last crack propagation leading to the final rupture of the specimen was not  
212 considered in this study.

213 The P- $\delta$  curves obtained during the tests, keeping only viable specimens, are shown by series in Figure  
214 16. On the  $0^\circ/90^\circ$  specimens, no anomaly is found during the tests, all the specimens can be used.  
215 There is already a greater variability for the  $0^\circ/0^\circ$  series compared to the  $0^\circ/90^\circ$  series.

### 216 **3.1. R-curves**

217 For the sake of clarity, only the fracture toughness and R-curves computed with the MCC method will  
218 be presented and illustrated in this sub-section.

219 A criterion for estimating repeatability during a DCB test campaign was the variability of the  
220 interpolation coefficients determined to correlate compliance and crack length. It is recalled that the  
221 MCC method uses an interpolation of  $\log(C)$  with  $\log(a)$ . The fitted curves are shown in Figure 17.  
222 The  $0^\circ/90^\circ$  series has a lower regression curve slope variability compared to  $0^\circ/0^\circ$  series. This lower  
223 variability is consistent with the variability observed on the P- $\delta$  curves (Figure 16). Note that the  
224 average R2 obtained for all fitting curves is 0.988 (SD: 0.011).

225 The first part of crack propagation, corresponding to the initiation of delamination, i.e. first  $G_{Ic}$  values,  
226 were not considered in this study, in accordance with ASTM D5528 (ASTM 2010).  $G_{Ic}$  values were

227 calculated only once the measured force had reached its maximum value and then decreased by 5%.

228 The R-curves obtained by the MCC method are shown in Figure 18.

229 The values for all the test specimens reported in Figure 18 shows that the average value of  $G_{Ic}$  is

230 higher for the  $0^\circ/0^\circ$  specimens than for the  $0^\circ/90^\circ$  ones. This difference is related to the difference of

231 the amount of fiber-bridging.  $0^\circ/0^\circ$  specimens exhibited larger amount of fiber-bridging than  $0^\circ/90^\circ$

232 ones. To validate this observation, the IR images obtained during the tests were subtracted one by one

233 to obtain the heating between each image. It was thus understood that the heating observed did not

234 come from the background, but from a self-heating in the specimen, related to a dissipation of energy

235 (fiber failure - Figure 19). The IR imagery provides a visualization of irreversible energy dissipation

236 through temperature variations. This self-heating, of the order of  $1^\circ\text{C}$  confirmed the presence of fiber

237 rupture, which can be observed in the post-mortem specimens of Figure 19. This variation of energy

238 is associated with fiber rupture because it is a phenomenon more energetic than decohesion alone [51],

239 and it was not throughout the whole test. Fiber bridging is more common in wood than in conventional

240 composites because the variability in the out-of-plane angle of the fibers is much higher than that

241 encountered in carbon composites [52].

242 In addition, there is a tendency for  $0^\circ/0^\circ$  ply  $G_{Ic}$  to increase throughout propagation. This has however

243 only been observed on a single specimen. The authors believe that this phenomenon cannot be clearly

244 identified in the others because the valid crack propagation (without ply failure or crack migration) is

245 too small. Fiber bridging is a two-step phenomenon: first fibers are being slowly pulled out and then

246 they are broken. That increase in force needed to break the fibers is the reason for the increase in

247 computed  $G_{Ic}$ . For the other specimens only the first part of the fiber bridging (fiber pull-out) is

248 observed. It has to be noted that for DCB tests on solid wood, during the fiber bridging, there are as

249 many fibers that break as fibers that bridge in the LT plane [53]. Fiber bridging is therefore a lot more

250 constant throughout crack propagation. In the present study, it seems that the low stiffness of the arms

251 of the DCB specimens made the pulled-out fibers break later.

252 As for the  $0^\circ/90^\circ$  series, the  $G_{Ic}$  remains quasi-constant, slightly decreasing, when the crack

253 propagates in the specimen. This can be explained by the fact that a lot less fiber bridging occurs in the

254 0°/90° specimens. There was therefore a much greater variability in the 0°/0° specimens. The average  
255 values of fracture toughness obtained were:  $G_{Ic-0°/0°} = 422 \text{ J/m}^2$  (RSD: 30%) and  $G_{Ic-0°/90°} = 247 \text{ J/m}^2$   
256 (RSD: 21%). However, once the measured force reaches its maximum value and then decreases by  
257 5%, the average initial  $G_{Ic}$ , as defined in ASTM D5528 (ASTM 2010), is similar between the 0°/0°  
258 specimens and the 0°/90° specimens.

259 To ensure that the potential error from the method used here to track the crack did not have a  
260 significant effect on the calculated  $G_{Ic}$  values, the  $G_{Ic}$  curves obtained were compared with curves  
261 obtained by adding artificial random noise on the measured crack lengths. By adding a random  
262 measurement error of +/-1.5 mm (a value higher than the maximum error observed in Figure 13), a  
263 maximum deviation of 1.75% was measured between the  $G_{Ic}$  curves (Figure 20). The method used to  
264 calculate  $G_{Ic}$  seems to be robust and the potential deviations of the crack length measurements do not  
265 disturb the calculated values.

266 In this sub-section, only the MCC method has been used to compute  $G_{Ic}$ . However, the results  
267 obtained with the two other methods presented (CC and MBT) differed with some specimens. Another  
268 method based on beam theory that does not require the use of the crack length can also be used to  
269 compute  $G_{Ic}$  with Equation 4 [54]:

$$G_{Ic} = \frac{3\delta P}{2b} \times \left( \frac{2}{E_1 I C} \right)^{1/3}$$

271 **Equation 4**

272 The four methods were compared for each specimen. Figure 21 illustrates the relative deviation  
273 between the MCC method and the other three methods. The comparison between the 4 methods on the  
274 0°/0° specimens shows large differences in half of the specimens. On 0°/90° specimens, there are  
275 significant differences only on a small number of specimens. However, there is little difference  
276 between the CC and MCC methods, and similarly between the MBT and beam theory methods. The  
277 small difference between the MBT method and the beam theory method is reassuring regarding crack  
278 tracking. The differences between on one side the methods based on beam theory (MBT and beam  
279 theory method) and on the other side the CC and MCC methods can be explained by the presence of

280 fiber bridging for the  $0^\circ/0^\circ$  specimens and the presence of fiber bridging in the  $90^\circ$  ply for the  $0^\circ/90^\circ$   
281 specimens. Methods based on beam theory considered perfect beams without the presence of fiber  
282 bridging, on the other hand, CC and MCC methods are calibrated with compliance as a function of the  
283 crack length, and so, offer more flexibility and indirectly consider the effect of fiber bridging.

284 However, the relative deviation between the mean  $G_{Ic}$  for the  $0^\circ/90^\circ$  specimens, computed with the  
285 MCC method and the MBT method, differed by only 7.5%. This relative deviation is comparable to  
286 that obtained by El Moustaphaoui et al. in Ceiba plywood [29]. Also, for the  $0^\circ/0^\circ$  specimens, this  
287 relative deviation is 21%. The rest of this paper will use the MCC method, as it, with the CC method,  
288 is the one that needs the weakest assumptions about the relationship between compliance and crack  
289 length. Furthermore, this method provides R2 coefficients closer to 1 on the calibration curves than the  
290 CC method does (Figure 17).

### 291 **3.2. Fracture Surfaces**

292 In the second step, the fracture surfaces of the specimens were analyzed to highlight the path of the  
293 crack and the presence of different physical phenomena. Note that the crack never seemed to  
294 propagate in the glue. The break was either adhesive, between the wood and the glue, or cohesive in  
295 the wood, but no cohesive break in the glue was observed when the fracture surfaces were observed  
296 under a microscope. This phenomenon has already been reported in wood assemblies, where the glue  
297 joint is known to be stronger than wood [55]. To relate the crack propagation and the  $G_{Ic}$  values  
298 obtained, other phenomena have been identified to classify crack propagation:

299 For  $0^\circ/0^\circ$  specimens:

- 300 • Crack at the  $0^\circ/0^\circ$  interface. It would seem that this crack is cohesive in the wood close to the  
301 glue interface between the two plies at  $0^\circ$ , and sometimes adhesive between the wood and the  
302 glue. However, these two rupture modes could be observed in the width of the specimen, so  
303 they will be considered together for the  $0^\circ/0^\circ$  interface crack propagation (zone **2** in Figure 24)
- 304 • Crack migration out of a plane (zone **3** in Figure 24)

305 For  $0^\circ/90^\circ$  specimens:

- 306 • Crack at the  $0^\circ/90^\circ$  interface (zone **4** in Figure 23)
- 307 • Propagation in the  $90^\circ$  ply (Figure 22 and zone **2** in Figure 23)
- 308 • Crack migration out of a plane or mixed event (zones 3 and 5 in Figure 23, and 3 in Figure 24)

309 As the propagation of the crack in the  $90^\circ$  ply seems to be in the lower part of the ply, the hypothesis  
310 that can be advanced for this phenomenon is that the upper part (which includes lathe checks) would  
311 not allow a simple propagation of the crack because the lathe check would be filled with glue. The  
312 crack would then naturally propagate in the lower part of the ply, which offers the least resistance.

313 In section **3.1**, an average R-curve was plotted for all the specimens. The idea now is to distinguish the  
314 different propagation phenomena on each specimen. For example, with specimen  $0^\circ/90^\circ$  no. 4,  $G_{Ic}$   
315 values are computed from line **1** in Figure 23, according to ASTM D5528 (ASTM 2010). The crack  
316 then propagates in the  $90^\circ$  ply (zone **2** in Figure 23) and passes to the interface by tearing fibers (zone  
317 **3** in Figure 23). This zone (**3**) is not used for the calculation of the  $G_{Ic}$  because it corresponds to a  
318 mixed phenomenon (bridging of fibers and passage of the crack at the  $0^\circ/90^\circ$  interface). To obtain an  
319 average value of  $G_{Ic}$  per type of crack propagation according to the classification proposed above,  
320 mixed phenomena are not considered since, in mixed zones, the effects of the individual phenomena  
321 on the  $G_{Ic}$  cannot be distinguished. The crack then propagates to the interface between the  $0^\circ$  and  $90^\circ$   
322 plies (zone **4** in Figure 23). The last part, in purple, corresponds to a similar propagation to zone 3,  
323 which cannot be classified and therefore is not considered (zone **5** in Figure 23). The end of the  
324 specimen is no longer in the field of view of the cameras and crack tracking is no longer possible (after  
325 zone **5** in Figure 23).

326 A similar analysis was carried out on the  $0^\circ/0^\circ$  specimens, as illustrated by the example of specimen  
327 no. 1 in Figure 24. The difference here is that only the propagation at the  $0^\circ/0^\circ$  interface (zone **2** in  
328 Figure 24) and particular events (mainly out-of-plane crack migration for these specimens) were  
329 considered (zone **3** in Figure 24).

330 By performing this analysis on each specimen, it is possible to calculate the crack propagation energy  
331 for each previously distinguished area. For the  $0^\circ/0^\circ$  specimens, the value calculated is identical to the

332 mean value obtained in §3.1 (the abnormal values have already been removed from this study as  
 333 explained in §3.1),  $G_{Ic-0^\circ/0^\circ} = 422 \text{ J/m}^2$  (RSD: 30%). For  $90^\circ/0^\circ$  specimens, the study of the fracture  
 334 surfaces reveals different R-curves and different average values depending on the zone of propagation  
 335 of the crack. To understand the different physical phenomena involved, it is interesting to compare the  
 336 present results with a theoretical model based on the Euler-Bernoulli beam theory [56]. This model  
 337 provides the following relations (Equation 5 and Equation 6):

$$C = \frac{2a^3}{3E_1I}$$

Equation 5

$$P(\delta) = \sqrt{\frac{2b^2}{3\delta} \sqrt{\frac{G_{Ic}^3 E_1 (h/2)^3}{12}}} = \frac{1}{\sqrt{\delta}} \left( \frac{4}{9} E_1 I \right)^{\frac{1}{4}} (b G_{Ic})^{\frac{3}{4}}$$

Equation 6

342 with I referring to the moment of inertia of a DCB specimen arm and  $E_1$  the longitudinal Young's  
 343 modulus.

344 By plotting  $P=f(\delta)$  using the measured  $\delta$  displacement, it is possible to visualize experimental and  
 345 theoretical curves on the same graph. Specimen  $0^\circ/90^\circ$  no. 4 is taken as an example here. A  
 346 comparison of the theoretical values observed with the R-curve of the same specimen gives the  
 347 minimum and maximum values observed ( $\sim 55$  and  $\sim 448 \text{ J/m}^2$  in this case).

348 The differences between the theoretical and experimental curves can be explained. Initially, the  
 349 experimental curve follows the theoretical curve for  $G_{Ic} = 188 \text{ J/m}^2$  (before zone 1 in Figure 25). There  
 350 is then a quasi-constant force on the  $P-\delta$  curve, which means that the energy required for the  
 351 propagation of the crack increases (zone 1 in Figure 25): when the crack propagates in the  $90^\circ$  ply, it  
 352 tends to follow lines of least resistance and create some fiber bridging (zone 2 in Figure 25). Fiber  
 353 bridging is not as frequent in the  $0^\circ/90^\circ$  specimens as in the  $0^\circ/0^\circ$  specimen but it nevertheless exists  
 354 and is shown in Figure 26. It should be noted, however, the out-of-plane bridging in the  $0^\circ/90^\circ$   
 355 specimens seems less marked, given the calculated energies compared to the  $0^\circ/0^\circ$  specimens. The



356 subsequent drop in force occurs when the crack migrates in an unstable way at the  $0^\circ/90^\circ$  interface  
357 after tearing fibers (zone 3 in Figure 25). It is then easier for the crack to propagate at the interface  
358 than between the wood cells and the locally accumulated energy dissipates, hence the fall of  $G_{Ic}$ . Note  
359 that this propagation at the interface takes place over a very short time; the value of  $G_{Ic}$  obtained can  
360 be influenced by viscosity phenomena due to wood or glue due to the dynamic propagation. The crack  
361 then resumes a tortuous path between the wood cells in the  $90^\circ$  ply, which again explains the increase  
362 in the value of  $G_{Ic}$ , as was the case in zone 2 in Figure 25 (zone 4 in Figure 25).

363 Note that, in the case where the crack propagates at the interface, the measurement points taken during  
364 the crack propagation are not considered for the calculation of the average value of  $G_{Ic}$ , because it is a  
365 dynamic propagation. Only the final and stable point is considered when the crack has stabilized. Due  
366 to the unstable propagation of the crack, these values underestimate the  $G_{Ic}$  (static value) of the  
367 interface. Note that the propagation in the  $0^\circ/90^\circ$  interface is observed on only two specimens and only  
368 a part of the crack propagation occurs at the interface, in both cases, it is an unstable propagation.  
369 Once the fracture propagation phenomenon has been detailed, it is possible to plot the R-curves for  
370 crack propagation at the  $0^\circ/90^\circ$  interface and in the  $90^\circ$  ply (Figure 27).

371 When the crack propagates in the  $90^\circ$  ply, it moves around the fibers, which contributes to the tortuous  
372 appearance of each R-curve. The value obtained for the fracture toughness in the  $90^\circ$  ply is  $G_{Ic-90^\circ\text{-ply}} =$   
373  $247 \text{ J/m}^2$  (RSD: 24%).

374 When the crack moves towards the  $0^\circ/90^\circ$  interface, there is a significant decrease in the value of  $G_{Ic}$ .  
375 This is because the crack no longer needs to bypass or break fibers to propagate and so requires a  
376 smaller amount of energy. The average value of the critical energy is obtained by taking the values  
377 calculated once the crack is installed in the interface. In the present case, only two values were  
378 obtained; they are visible in Figure 27. The value found for the critical fracture toughness at the  
379 interface  $0^\circ/90^\circ$  is  $G_{Ic-0^\circ/90^\circ\text{-interface}} = 62 \text{ J/m}^2$  (RSD: 28%). However, a low degree of confidence is to  
380 apply to this value given the very low number of test configurations on which this phenomenon  
381 appeared and its dynamic aspect. The value to use is therefore  $G_{Ic-90^\circ\text{-ply}} = 247 \text{ J/m}^2$  (RSD: 24%).

382 **4. Discussion**

383 In the literature, the values of  $G_{Ic}$  on a  $0^\circ/0^\circ$  interface of LVL or glulam are between about 20 and 850  
 384  $J/m^2$ . These values are summarized in Table 1.

Authors	Material	$G_{Ic}$ (J/m <sup>2</sup> ) Min/max
[30]	6-ply beech plywood [0°/90°/0°]/[0°/90°/0°]	~20
[28]	9-ply ceiba plywood [undisclosed stacking sequence]	~140 to 200
[33]	Beech glulam	~30 to 80
[37]	Poplar glulam	~120 to 230
[31]	Scots pine glulam	~150 to 250
[32]	Poplar glulam	~200 to 300
[34]	Maritime pine glulam	~220 to 465
[35]	Maritime pine glulam	~ 400 to 550
[36]	Beech glulam	~ 827 ± 239

385 **Table 1 – Comparison of the orders of magnitude of  $G_{Ic}$**

386 Few authors have investigated plywood toughness, which is why some  $G_{Ic}$  values obtained on glulam  
 387 are compared here. It is important to note that the thicknesses of wood lumber and veneers are not  
 388 identical and therefore there is a scale effect between these materials. However, the differences  
 389 between the authors' findings can be explained mainly by the type of wood and glue used in the  
 390 manufacturing of the plywood or glulam characterized. The toughness of a glued assembly is strongly  
 391 correlated with the nature of the wood-glue combination. In addition, the fracture energy of the  
 392 assembly will also be influenced by the roughness of the wood, the thickness of the glue joint or  
 393 Young's modulus of the material characterized [57]. Similarly, a strong dispersion is expected on tests  
 394 such as DCB applied to wood and wood composite materials due to the heterogeneity of wood  
 395 material and the variability of its mechanical properties [57]. Some average values for standard  
 396 composites in aeronautics are summarized in Table 2. The mean value of toughness obtains for  $0^\circ/0^\circ$   
 397 specimens is in the same order of magnitude as thermoset composites.

Authors	Material	$G_{Ic}$ (J/m <sup>2</sup> )
[58]	UD carbon/epoxy 1st generation (type 3506)	60
[39]	UD carbon/epoxy 2nd generation (type M21)	450
[59]	UD carbon/PEEK (type APC-2)	2200
[60]	UD carbon/PPS	1100
[38]	U.D. Glass/epoxy	800
[61]	U.D. Glass-E/polyester	300

398

**Table 2 – Some  $G_{Ic}$  values for standard composites in aeronautics [62]**

399 The literature does not provide a value of  $G_{Ic}$  for a  $0^\circ/90^\circ$  interface in the case of plywood. However,  
400 given the results obtained during this study, it can be seen that the value of  $G_{Ic}$  for a  $0^\circ/90^\circ$  interface  
401 ( $G_{Ic-90^\circ} = 247 \text{ J/m}^2$  (RSD: 21%)) is lower than for a  $0^\circ/0^\circ$  interface ( $G_{Ic-0^\circ/0^\circ} = 422 \text{ J/m}^2$  (RSD: 30%))  
402 because fiber bridging is less present than in a  $0^\circ/0^\circ$  interface. Note that the value of  $G_{Ic}$  for an  $0^\circ/0^\circ$   
403 interface measured experimentally overestimates the value of delamination compared to a pure  
404 interface without the effects of fiber bridging and fiber rupture. It is therefore possible to wonder  
405 whether the toughness characterized for a  $0^\circ/90^\circ$  interface is not to be preferred if the aim is to obtain  
406 a numerical value of the mode I fracture toughness of a plywood interface by limiting the influence of  
407 fiber bridging. Moreover, according to research [63], the interface  $0^\circ/90^\circ$  is the most susceptible to  
408 delamination in cases of impact-induced delamination. The value obtained will be a value that is less  
409 influenced by fiber bridging and closer to the theoretical value that will subsequently be used for the  
410 implementation of a finite element model to simulate the glued interface.

411 It is also interesting to compare the fracture pattern found in this study with those recorded in DCB  
412 tests on carbon fiber composite materials. The configuration with a  $0^\circ/0^\circ$  interface allows the  
413 boundary value of  $G_{Ic}$  to be lowered in the case of synthetic composite materials because it is the  
414 configuration that gives the least fiber bridging and the  $0^\circ$  fibers at the interface prevent delamination  
415 migration [39], [64], [65]. Figure 28 illustrates a representative side view of the crack path of such an  
416 interface.

417 In the case of wood, the crack rapidly migrates outside the initial interface. There are several possible  
418 explanations for this phenomenon. First, the wood has fibers with a non-zero out-of-plane deviation of  
419 the fiber angle due to the manufacturing process, a situation that is much less common for composites.  
420 Additionally, the thickness of a wood veneer can be composed of earlywood and latewood (Figure 5)  
421 and this heterogeneity could create an easier propagation path for the crack. Finally, in wood  
422 assemblies, the glue joint is known to be stronger than wood [55]. This phenomenon can cause the  
423 crack to propagate cohesively near the interface for the  $0^\circ/0^\circ$  specimens and mostly in the  $90^\circ$  ply for  
424 the  $0^\circ/90^\circ$  specimens. This is exactly what has been observed on IMA/M21E composites: the glued  
425 interface is stronger than the plies [23], [66].

426 In the second configuration of composite materials, with a  $0^\circ/90^\circ$  interface, the crack may change  
427 plane during delamination [39] (Figure 29). [This delamination migration in synthetic composite](#)  
428 [material tends to increase the fracture area and to dissipate more energy \[40\]. According to Sebaey et](#)  
429 [al., their numerical model demonstrates that as the bending stiffness of specimen arms decreases, there](#)  
430 [is an increased propensity for delamination migration at the interface \[67\]. However, for plywood,](#)  
431 [delamination migration doesn't occur on specimen with  \$0^\circ/90^\circ\$  interface.](#)

432 [Concerning fiber bridging, the phenomenon is less important for this configuration compared to](#)  
433 [specimens with  \$0^\circ/0^\circ\$  interface. Due to the propagation of the crack in the  \$90^\circ\$  ply, the few fiber](#)  
434 [bridging behavior observed is comparable to that of a  \$90^\circ/90^\circ\$  interface in synthetic composite \[40\],](#)  
435 [\[65\].](#)

436 Considering the nature of the wood, with the presence of out-of-plane fibers and a greater fiber  
437 bridging, it is possible to explain why the value of  $G_{Ic}$  for a  $0^\circ/0^\circ$  interface is not a lower bound  $G_{Ic}$   
438 value for plywood while this is the case for composite materials [39], [40], [50]. In addition, fracture  
439 pattern and crack propagation appear similar when crack propagations are compared for  $0^\circ/90^\circ$   
440 interfaces in the cases of plywood and composite materials.

## 441 **5. Conclusions and Perspectives**

442 The effects of interfacial orientation for two different configurations were investigated in DCB tests on  
443 poplar plywood. The following conclusions can be drawn from the results of the study:

- 444 • On the R-curves,  $G_{Ic-0^\circ/0^\circ}$  tends to increase, due to fiber bridging, while the average value of  
445  $G_{Ic-0^\circ/90^\circ}$  remains quasi-constant, slightly decreasing, as a function of the crack propagation.
- 446 • The values of  $G_{Ic-0^\circ/0^\circ}$  ( $G_{Ic-0^\circ/0^\circ} = 422 \text{ J/m}^2$  (RSD: 30%)) are more scattered than  $G_{Ic-0^\circ/90^\circ}$  ( $G_{Ic-}$   
447  $0^\circ/90^\circ = 247 \text{ J/m}^2$  (RSD: 21%)). This is explained by the presence of fiber bridging during the  
448 crack propagation in the case of the  $0^\circ/0^\circ$  interface.
- 449 • On average, the  $G_{Ic-0^\circ/0^\circ}$  has a higher value than  $G_{Ic-0^\circ/90^\circ}$ , due to the presence of fiber bridging.  
450 It is interesting to perform DCB tests with a  $0^\circ/90^\circ$  interface to obtain  $G_{Ic}$  values for plywood,  
451 for the development of numerical models. This interface corresponds to those most likely to  
452 delaminate. The apparent toughness, i.e. the toughness computed with the influence of  
453 structural effects such as fiber bridging, could differ from the intrinsic material toughness  
454 value. However, the values presented in this article provide values for comparing the effect of  
455 the interface on delamination. It should also be noted that some fiber bridging also influences  
456 the values obtained on  $0^\circ/90^\circ$  specimens.

457 To implement a numerical model of wood-based composite, specimen characterization with  $0^\circ/90^\circ$   
458 interfaces seems to provide a lower bound for the interface toughness value that could serve as a  
459 reference for modelling glued interfaces of plywood or LVL, for example. However, further research  
460 is needed to determine the influence of new interface orientations on these toughness values and to  
461 identify the influence of this interface on the measured values. In addition, in low-velocity impact  
462 failure, mode I initiate the delamination in composite laminates, but then mode II (plane shear) is  
463 predominant in the propagation of the crack due to high shear stress at the interface [68]. To set up a  
464 digital model of plywood, it would then be necessary to characterize mode II toughness through, for  
465 example, ENF (End Notched Flexure) tests. [However, it has to be underlined that delamination  
466 migration can also occur in mode II propagation, it's already observed in LVL \[69\] and in carbon fibre  
467 composite with ENF tests \[70\], \[71\].](#)

## 468 6. Acknowledgments

469 The research that led to the results presented above received funds from the French National Research  
470 Agency under the BOOST project (ANR-21-CE43-0008-01). The authors thank the LaBoMaP  
471 Laboratory, Cluny, France for providing the Poplar veneers used in this study, through the research  
472 project ANR BOOST.

## 473 7. References

- 474 [1] G. Wimmers, ‘Wood: a construction material for tall buildings’, *Nat. Rev. Mater.*, vol. 2, p.  
475 17051, Jul. 2017, doi: 10.1038/natrevmats.2017.51.
- 476 [2] J. Ye and C. Fivet, ‘The zaojing: review of a unique wooden construction typology’, *Int. J.*  
477 *Constr. Hist. Soc.*, vol. 35, no. 1, pp. 22–49, Jun. 2020, doi: 10.5281/zenodo.3941502.
- 478 [3] B. Castanie, C. Bouvet, and M. Ginot, ‘Review of composite sandwich structure in aeronautic  
479 applications’, *Compos. Part C Open Access*, vol. 1, p. 100004, Aug. 2020, doi:  
480 10.1016/j.jcomc.2020.100004.
- 481 [4] G. Jungmeier, F. Werner, A. Jarnehammar, C. Hohenthal, and K. Richter, ‘Allocation in LCA of  
482 wood-based products experiences of cost action E9: Part I. Methodology’, *Int. J. Life Cycle*  
483 *Assess.*, vol. 7, no. 5, pp. 290–294, Sep. 2002, doi: 10.1007/BF02978890.
- 484 [5] G. Jungmeier, F. Werner, A. Jarnehammar, C. Hohenthal, and K. Richter, ‘Allocation in LCA of  
485 wood-based products experiences of cost action E9: Part II. Examples’, *Int. J. Life Cycle Assess.*,  
486 vol. 7, no. 6, pp. 369–375, Nov. 2002, doi: 10.1007/BF02978686.
- 487 [6] R. Bergman, M. Puettmann, A. Taylor, and K. E. Skog, ‘The Carbon Impacts of Wood  
488 Products’, *For. Prod. J.*, vol. 64, no. 7–8, pp. 220–231, Dec. 2014, doi: 10.13073/FPJ-D-14-  
489 00047.
- 490 [7] C. Cornillier and E. Vial, ‘L’Analyse de Cycle de Vie (ACV) appliquée aux produits bois : bilan  
491 énergétique et prise en compte du carbone biomasse’, presented at the IXème Colloque Sciences  
492 et Industrie du Bois, 2008, p. 16.
- 493 [8] K. Tamanna, S. N. Raman, M. Jamil, and R. Hamid, ‘Utilization of wood waste ash in  
494 construction technology: A review’, *Constr. Build. Mater.*, vol. 237, p. 117654, Mar. 2020, doi:  
495 10.1016/j.conbuildmat.2019.117654.
- 496 [9] Finnish Woodworking Industries Federation, Ed., *LVL handbook Europe*. Helsinki: Federation  
497 of the Finnish Woodworking Industries, 2019.
- 498 [10] Y. Kiliç, E. Burdurlu, G. C. Elibol, and M. Ulupinar, ‘Effect of Layer Arrangement on  
499 Expansion, Bending Strength and Modulus of Elasticity of Solid Wood and Laminated Veneer  
500 Lumber (LVL) Produced from Pine and Poplar’, p. 7, 2010.
- 501 [11] R. H. Leicester and R. C. Bunker, ‘Fracture at butt joints in laminated pine’, *For. Prod J* 192 59-  
502 60, 1969.
- 503 [12] H. Sasaki and A. A. Abdullahi, ‘Lumber: Laminated Veneer’, in *Reference Module in Materials*  
504 *Science and Materials Engineering*, Elsevier, 2016, p. B9780128035818020000. doi:  
505 10.1016/B978-0-12-803581-8.01989-5.
- 506 [13] J. A. Youngquist, T. L. Laufenberg, and B. S. Bryant, ‘End jointing of laminated veneer lumber  
507 for structural use’, *For. Prod. J.*, p. 8, 1984.
- 508 [14] R. Guélou, F. Eyma, A. Cantarel, S. Rivallant, and B. Castanié, ‘A comparison of three wood  
509 species (poplar, birch and oak) for crash application’, *Eur. J. Wood Wood Prod.*, Aug. 2022, doi:  
510 10.1007/s00107-022-01871-x.
- 511 [15] J. Susainathan, F. Eyma, E. De Luycker, A. Cantarel, C. Bouvet, and B. Castanie, ‘Experimental  
512 investigation of compression and compression after impact of wood-based sandwich structures’,  
513 *Compos. Struct.*, vol. 220, pp. 236–249, Jul. 2019, doi: 10.1016/j.compstruct.2019.03.095.
- 514 [16] R. Guélou, F. Eyma, A. Cantarel, S. Rivallant, and B. Castanié, ‘Static crushing of wood based  
515 sandwich composite tubes’, *Compos. Struct.*, vol. 273, 2021, doi:  
516 10.1016/j.compstruct.2021.114317.

- 517 [17] R. Guélou, F. Eyma, A. Cantarel, S. Rivallant, and B. Castanié, ‘Crashworthiness of poplar  
518 wood veneer tubes’, *Int. J. Impact Eng.*, vol. 147, p. 103738, Jan. 2021, doi:  
519 10.1016/j.ijimpeng.2020.103738.
- 520 [18] R. Guélou, F. Eyma, A. Cantarel, S. Rivallant, and B. Castanié, ‘Dynamic crushing of wood-  
521 based sandwich composite tubes’, *Mech. Adv. Mater. Struct.*, pp. 1–21, Oct. 2021, doi:  
522 10.1080/15376494.2021.1991533.
- 523 [19] J. Susainathan, F. Eyma, E. De Luycker, A. Cantarel, and B. Castanie, ‘Manufacturing and  
524 quasi-static bending behavior of wood-based sandwich structures’, *Compos. Struct.*, vol. 182, pp.  
525 487–504, Dec. 2017, doi: 10.1016/j.compstruct.2017.09.034.
- 526 [20] J. Susainathan, F. Eyma, E. De Luycker, A. Cantarel, and B. Castanie, ‘Experimental  
527 investigation of impact behavior of wood-based sandwich structures’, *Compos. Part Appl. Sci.*  
528 *Manuf.*, vol. 109, pp. 10–19, Jun. 2018, doi: 10.1016/j.compositesa.2018.02.029.
- 529 [21] J. Susainathan, F. Eyma, E. De Luycker, A. Cantarel, and B. Castanie, ‘Numerical modeling of  
530 impact on wood-based sandwich structures’, *Mech. Adv. Mater. Struct.*, vol. 27, no. 18, Art. no.  
531 18, Sep. 2020, doi: 10.1080/15376494.2018.1519619.
- 532 [22] S. Abrate, B. Castanié, and Y. D. S. Rajapakse, Eds., *Dynamic Failure of Composite and*  
533 *Sandwich Structures*, vol. 192. in *Solid Mechanics and Its Applications*, vol. 192. Dordrecht:  
534 Springer Netherlands, 2013. doi: 10.1007/978-94-007-5329-7.
- 535 [23] L. Adam, C. Bouvet, B. Castanié, A. Daidié, and E. Bonhomme, ‘Discrete ply model of circular  
536 pull-through test of fasteners in laminates’, *Compos. Struct.*, vol. 94, no. 10, pp. 3082–3091, Oct.  
537 2012, doi: 10.1016/j.compstruct.2012.05.008.
- 538 [24] C. Bouvet, B. Castanié, M. Bizeul, and J.-J. Barrau, ‘Low velocity impact modelling in laminate  
539 composite panels with discrete interface elements’, *Int. J. Solids Struct.*, vol. 46, no. 14, pp.  
540 2809–2821, Jul. 2009, doi: 10.1016/j.ijsolstr.2009.03.010.
- 541 [25] J. Serra, C. Bouvet, B. Castanié, and C. Petiot, ‘Scaling effect in notched composites: The  
542 Discrete Ply Model approach’, *Compos. Struct.*, vol. 148, pp. 127–143, Jul. 2016, doi:  
543 10.1016/j.compstruct.2016.03.062.
- 544 [26] J. Konnerth, W. Gindl, M. Harm, and U. Müller, ‘Comparing dry bond strength of spruce and  
545 beech wood glued with different adhesives by means of scarf- and lap joint testing method’, *Holz*  
546 *Als Roh- Werkst.*, vol. 64, no. 4, pp. 269–271, Aug. 2006, doi: 10.1007/s00107-006-0104-1.
- 547 [27] F. Lachaud, ‘Delamination de matériaux composites a fibres de carbone et a matrices organiques :  
548 etude numerique et experimentale, suivi par emission acoustique’, PhD Thesis, Université de  
549 Toulouse - ISAE, Toulouse, 1997.
- 550 [28] A. El Moustaphaoui, A. Chouaf, and K. Kimakh, ‘Experimental and numerical study of the  
551 delamination of Ceiba plywood under mode I, mode II and mixed-mode (I + II) loading using  
552 the DCB, ELS and MMF tests’, *Int. J. Fract.*, Jun. 2021, doi: 10.1007/s10704-021-00557-4.
- 553 [29] A. El Moustaphaoui, A. Chouaf, K. Kimakh, and M. Chergui, ‘Characterization of ceiba  
554 plywood delamination in mode I using an energetic criterion’, *Wood Res.*, vol. 64, p. 12, 2019.
- 555 [30] M. N. Baba, F. Dogaru, I. Curtu, G. Dinu, and M. Bayer, ‘Experimental Determination of  
556 Interlaminar Fracture Toughness of Wood Laminated Composite Specimens under DCB Test’,  
557 *Mater. Plast.*, p. 5, 2010.
- 558 [31] Y. Zhao, Z. Li, and B. Xu, ‘Mixed-mode (I/II) interlaminar fracture of glued-laminated timber’,  
559 *Mater. Des.*, vol. 131, pp. 210–218, Oct. 2017, doi: 10.1016/j.matdes.2017.05.070.
- 560 [32] J. Jennings, ‘Investigating the Surface Energy, and Bond Performance of Compression Densified  
561 Wood’, Blacksburg, Virginia, 2003.
- 562 [33] M. Rhême, J. Botsis, J. Cugnani, and P. Navi, ‘Influence of the moisture content on the fracture  
563 characteristics of welded wood joint. Part 1: Mode I fracture’, *Holzforschung*, vol. 67, no. 7, pp.  
564 747–754, 2013.
- 565 [34] J. Xavier, J. Morais, N. Dourado, and M. F. S. F. De Moura, ‘Measurement of Mode I and Mode  
566 II Fracture Properties of Wood-Bonded Joints’, *J. Adhes. Sci. Technol.*, vol. 25, no. 20, pp.  
567 2881–2895, Jan. 2011, doi: 10.1163/016942411X576563.
- 568 [35] F. G. A. Silva, J. Xavier, F. A. M. Pereira, J. J. L. Morais, N. Dourado, and M. F. S. F. Moura,  
569 ‘Determination of cohesive laws in wood bonded joints under mode I loading using the DCB  
570 test’, *Holzforschung*, vol. 67, no. 8, Art. no. 8, Dec. 2013, doi: 10.1515/hf-2013-0012.

- 571 [36] S. Myslicki, T. Vallée, O. Bletz-Mühldorfer, F. Diehl, L. C. Lavarec, and R. Créac'Hcadeç,  
572 'Fracture mechanics based joint capacity prediction of glued-in rods with beech laminated  
573 veneer lumber', *J. Adhes.*, vol. 95, no. 5–7, pp. 405–424, Jun. 2019, doi:  
574 10.1080/00218464.2018.1538879.
- 575 [37] C. R. Scoville, 'Characterizing the Durability of PF and pMDI Adhesive Wood Composites  
576 Through Fracture Testing', PhD Thesis, Virginia Tech, 2001. Accessed: May 09, 2022. [Online].  
577 Available: <https://vtechworks.lib.vt.edu/handle/10919/35353>
- 578 [38] D. Gay, *Composite Materials: Design and Applications*, 3rd edition. CRC Press, 2014.
- 579 [39] P. Prombut, 'Caractérisation de la propagation de délaminage des stratifiées composites  
580 multidirectionnelles', PhD Thesis, Université de Toulouse III – Paul Sabatier, Toulouse, 2007.
- 581 [40] Y. Gong *et al.*, 'Delamination in carbon fiber epoxy DCB laminates with different stacking  
582 sequences: R-curve behavior and bridging traction-separation relation', *Compos. Struct.*, vol.  
583 262, p. 113605, Apr. 2021, doi: 10.1016/j.compstruct.2021.113605.
- 584 [41] G. R. Irwin and J. A. Kies, 'The welding journal', *Res Suppl*, vol. 33, p. 193, 1954.
- 585 [42] L. Denaud *et al.*, 'Influence of Peeling Process Parameters on Veneer Lathe Check Properties',  
586 presented at the 24th International Wood Machining Semina, Corvallis, OR, USA, Aug. 2019.
- 587 [43] G. Pot, L. Denaud, J.-C. Butaud, S. Girardon, R. Collet, and F. Cottin, 'Experimental study of  
588 the influence of veneer lathe checks on LVL elastic mechanical properties', Aug. 2016.
- 589 [44] S. Stefanowski, R. Frayssinhes, G. Pinkowski, and L. Denaud, 'Study on the in-process  
590 measurements of the surface roughness of Douglas fir green veneers with the use of laser  
591 profilometer', *Eur. J. Wood Wood Prod.*, vol. 78, no. 3, pp. 555–564, May 2020, doi:  
592 10.1007/s00107-020-01529-6.
- 593 [45] I. Rahayu, L. Denaud, R. Marchal, and W. Darmawan, 'Ten new poplar cultivars provide  
594 laminated veneer lumber for structural application', *Ann. For. Sci.*, vol. 72, no. 6, pp. 705–715,  
595 Sep. 2015, doi: 10.1007/s13595-014-0422-0.
- 596 [46] J. Gáborík and K. Káčerová, 'Bending properties of laminated wood from juvenile poplar.',  
597 *Proc. 2nd Int. Sci. Conf. Woodwork. Tech. Zalesina Croat. 11-15 Sept. 2007*, pp. 233–240, 2007.
- 598 [47] F. F. P. Kollmann, W. A. Côté, E. W. Kuenzi, and A. J. Stamm, *Principles of Wood Science and*  
599 *Technology: Solid wood*. G. Allen & Unwin, 1968.
- 600 [48] W. Leggate, R. McGavin, and H. Bailleres, *A guide to manufacturing rotary veneer and*  
601 *products from small logs*, ACIAR Monograph. 2017.
- 602 [49] P. Reu, 'All about speckles: Speckle Size Measurement', *Exp. Tech.*, vol. 38, no. 6, pp. 1–2,  
603 Nov. 2014, doi: 10.1111/ext.12110.
- 604 [50] A. Ramji, Y. Xu, M. Yasaei, M. Grasso, and P. Webb, 'Delamination migration in CFRP  
605 laminates under mode I loading', *Compos. Sci. Technol.*, vol. 190, p. 108067, Apr. 2020, doi:  
606 10.1016/j.compscitech.2020.108067.
- 607 [51] T. Lisle, C. Bouvet, N. Hongkarnjanakul, M.-L. Pastor, S. Rivallant, and P. Margueres, 'Measure  
608 of fracture toughness of compressive fiber failure in composite structures using infrared  
609 thermography', *Compos. Sci. Technol.*, vol. 112, pp. 22–33, May 2015, doi:  
610 10.1016/j.compscitech.2015.03.005.
- 611 [52] M. Pramreiter, S. C. Bodner, J. Keckes, A. Stadlmann, C. Kumpenza, and U. Müller, 'Influence  
612 of Fiber Deviation on Strength of Thin Birch (*Betula pendula* Roth.) Veneers', *Materials*, vol.  
613 13, no. 7, Art. no. 7, Mar. 2020, doi: 10.3390/ma13071484.
- 614 [53] J. L. Gómez-Royuela, A. Majano-Majano, A. J. Lara-Bocanegra, J. Xavier, and M. F. S. F. de  
615 Moura, 'Evaluation of R-curves and cohesive law in mode I of European beech', *Theor. Appl.*  
616 *Fract. Mech.*, vol. 118, p. 103220, Apr. 2022, doi: 10.1016/j.tafmec.2021.103220.
- 617 [54] S. Hashemi, A. Jame Kinlock, and J. M. Williams, 'The analysis of interlaminar fracture in  
618 uniaxial fibre-polymer composites', *Proc. R. Soc. Lond. Math. Phys. Sci.*, vol. 427, no. 1872, pp.  
619 173–199, Jan. 1990, doi: <https://doi.org/10.1098/rspa.1990.0007>.
- 620 [55] R. J. Ross and F. P. Laboratory. USDA Forest Service., 'Wood handbook : wood as an  
621 engineering material', U.S. Department of Agriculture, Forest Service, Forest Products  
622 Laboratory, Madison, WI, FPL-GTR-190, 2010. doi: 10.2737/FPL-GTR-190.
- 623 [56] N. Ben Salem, 'Fiabilité des assemblages structuraux collés pour applications spatiales', PhD  
624 Thesis, Bordeaux 1, 2012. Accessed: Oct. 19, 2022. [Online]. Available:  
625 <https://www.theses.fr/2012BOR14681>



- 626 [57] G. Pluinage, *La rupture du bois et de ses composites*, Cépaduès-Éditions. 1992. Accessed: Aug.  
627 24, 2021. [Online]. Available: <https://www.eyrolles.com/BTP/Livre/la-rupture-du-bois-et-de-628 ses-composites-9782854282924/>
- 629 [58] B. W. Kim and A. H. Mayer, ‘Influence of fiber direction and mixed-mode ratio on delamination  
630 fracture toughness of carbon/epoxy laminates’, *Compos. Sci. Technol.*, vol. 63, no. 5, pp. 695–  
631 713, Apr. 2003, doi: 10.1016/S0266-3538(02)00258-0.
- 632 [59] S. Hashemi, A. J. Kinloch, and J. G. Williams, ‘The Effects of Geometry, Rate and Temperature  
633 on the Mode I, Mode II and Mixed-Mode I/II Interlaminar Fracture of Carbon-Fibre/Poly(ether-  
634 ether ketone) Composites’, *J. Compos. Mater.*, vol. 24, no. 9, pp. 918–956, Sep. 1990, doi:  
635 10.1177/002199839002400902.
- 636 [60] F. Sacchetti, W. J. B. Groupe, L. L. Warnet, and I. F. Villegas, ‘Effect of cooling rate on the  
637 interlaminar fracture toughness of unidirectional Carbon/PPS laminates’, *Eng. Fract. Mech.*, vol.  
638 203, pp. 126–136, Nov. 2018, doi: 10.1016/j.engfracmech.2018.02.022.
- 639 [61] A. Szekrényes, ‘Delamination fracture analysis in the GII–GIII plane using prestressed  
640 transparent composite beams’, *Int. J. Solids Struct.*, vol. 44, no. 10, pp. 3359–3378, May 2007,  
641 doi: 10.1016/j.ijsolstr.2006.09.029.
- 642 [62] C. Bouvet, ‘Mécanique de la rupture des composites : délaminage et fissuration’, *Systèmes*  
643 *Aéronautiques Spatiaux*, Feb. 2019, doi: 10.51257/a-v1-trp4043.
- 644 [63] D. Liu, ‘Impact-Induced Delamination: A View of Bending Stiffness Mismatching’, *J. Compos.*  
645 *Mater.*, vol. 22, 1988.
- 646 [64] A. Sohrabi, M. Pourhosseinshahi, and B. Mohammadi, ‘Prediction of mode I fracture behavior  
647 of delaminated 0//90 interface in cross-ply laminated composites from the SERR of classical  
648 unidirectional DCB specimen’, *Compos. Struct.*, vol. 317, p. 117080, Aug. 2023, doi:  
649 10.1016/j.compstruct.2023.117080.
- 650 [65] M. S. Bin Mohamed Rehan, J. Rousseau, S. Fontaine, and X. J. Gong, ‘Experimental study of  
651 the influence of ply orientation on DCB mode-I delamination behavior by using multidirectional  
652 fully isotropic carbon/epoxy laminates’, *Compos. Struct.*, vol. 161, pp. 1–7, Feb. 2017, doi:  
653 10.1016/j.compstruct.2016.11.036.
- 654 [66] S. Chaïbi, ‘Prévision des endommagements induits par un impact basse vitesse/basse énergie au  
655 sein de matériaux composites stratifiés carbone-epoxy de dernière génération’, PhD Thesis,  
656 Université de Toulouse - ISAE, Toulouse, 2022.
- 657 [67] T. A. Sebaey, N. Blanco, C. S. Lopes, and J. Costa, ‘Numerical investigation to prevent crack  
658 jumping in Double Cantilever Beam tests of multidirectional composite laminates’, *Compos. Sci.*  
659 *Technol.*, vol. 71, no. 13, pp. 1587–1592, Sep. 2011, doi: 10.1016/j.compscitech.2011.07.002.
- 660 [68] C. Bouvet, S. Rivallant, and J. J. Barrau, ‘Low velocity impact modeling in composite laminates  
661 capturing permanent indentation’, *Compos. Sci. Technol.*, vol. 72, no. 16, pp. 1977–1988, Nov.  
662 2012, doi: 10.1016/j.compscitech.2012.08.019.
- 663 [69] B. Franke and P. Quenneville, ‘Analysis of the fracture behavior of Radiata Pine timber and  
664 Laminated Veneer Lumber’, *Eng. Fract. Mech.*, vol. 116, pp. 1–12, Jan. 2014, doi:  
665 10.1016/j.engfracmech.2013.12.004.
- 666 [70] S. Oshima, A. Mamishin, M. Hojo, M. Nishikawa, N. Matsuda, and M. Kanesaki, ‘High-  
667 resolution in situ characterization of micromechanisms in CFRP laminates under mode II  
668 loading’, *Eng. Fract. Mech.*, vol. 260, p. 108189, Feb. 2022, doi:  
669 10.1016/j.engfracmech.2021.108189.
- 670 [71] M. Olave, I. Vara, H. Usabiaga, L. Aretxabaleta, S. V. Lomov, and D. Vandepitte, ‘Nesting  
671 effect on the mode II fracture toughness of woven laminates’, *Compos. Part Appl. Sci. Manuf.*,  
672 vol. 74, pp. 174–181, Jul. 2015, doi: 10.1016/j.compositesa.2015.03.020.
- 673 [72] N. M. M. Dourado, M. F. S. F. de Moura, J. J. L. Morais, and M. A. L. Silva, ‘Estimate of  
674 resistance-curve in wood through the double cantilever beam test’, *Holzforschung*, vol. 64, no. 1,  
675 Jan. 2010, doi: 10.1515/hf.2010.010.
- 676 [73] R. Duriot *et al.*, ‘New Perspectives for LVL Manufacturing from Wood of Heterogeneous  
677 Quality—Part. 1: Veneer Mechanical Grading Based on Online Local Wood Fiber Orientation  
678 Measurement’, *Forests*, vol. 12, no. 9, Art. no. 9, Sep. 2021, doi: 10.3390/f12091264.
- 679 [74] H. G. Richter, K. Gembruch, and G. Koch, ‘CITESwoodID - introduction’, *delta-intkey*, Sep. 20,  
680 2019. <https://www.delta-intkey.com/citeswood/en/intro.htm> (accessed Jan. 13, 2023).



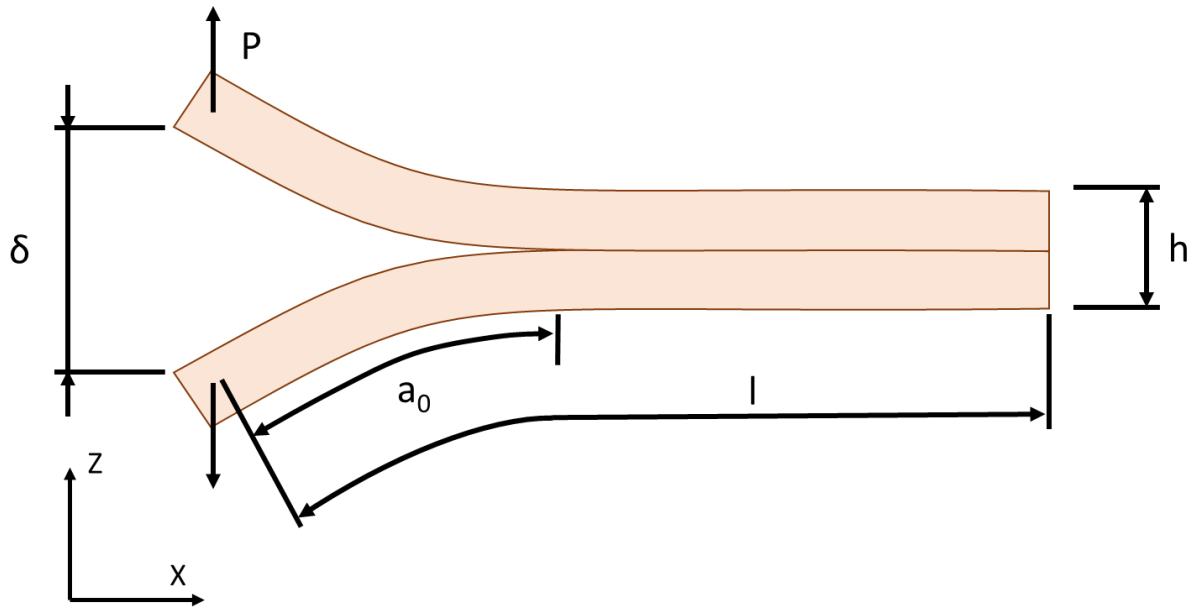

682

683

Figure 1- Sketch of the double cantilever beam [72]

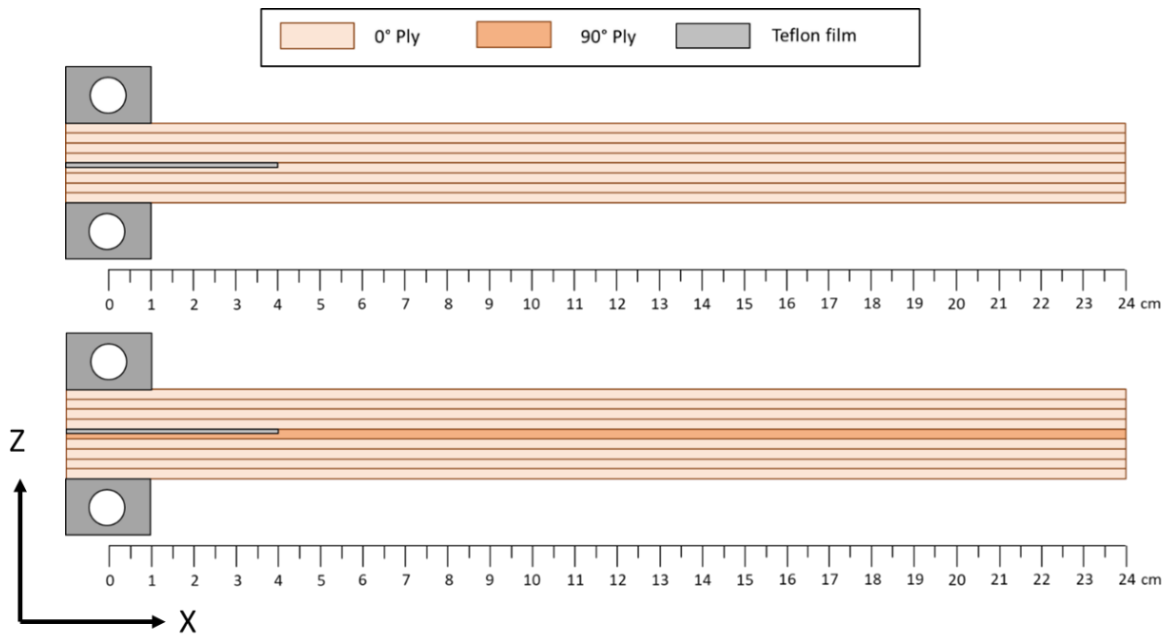

684

685

Figure 2- DCB specimen configuration for  $0^\circ/0^\circ$  interface (top) and  $0^\circ/90^\circ$  interface (bottom)

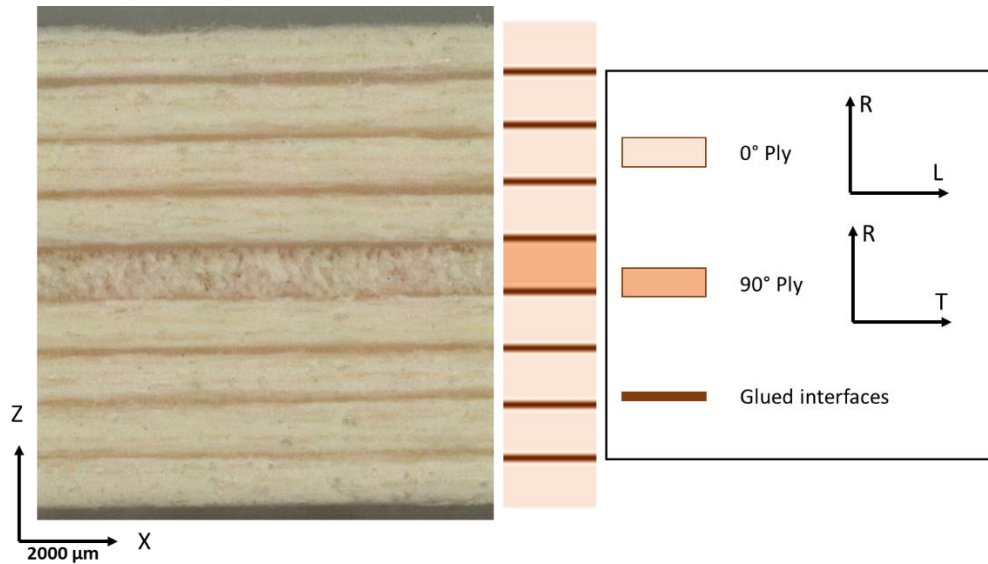

686

687

**Figure 3- Microscope visualization of 0°/90° specimen thickness**

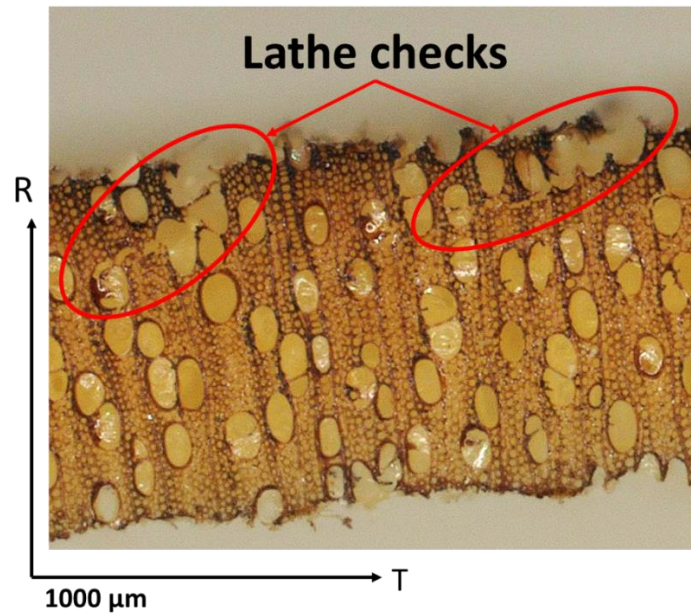

688

689

**Figure 4- Visible lathe checks on the poplar ply**

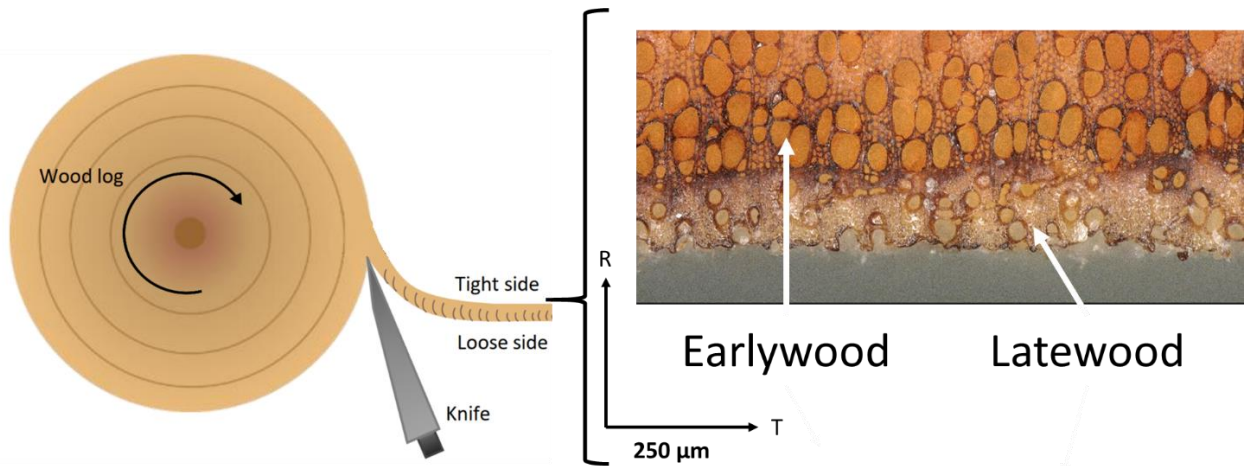

690

691

**Figure 5 – Illustration of the veneer production process (left) [73] and a microscopic view of**

692

**earlywood and latewood on veneers (right)**

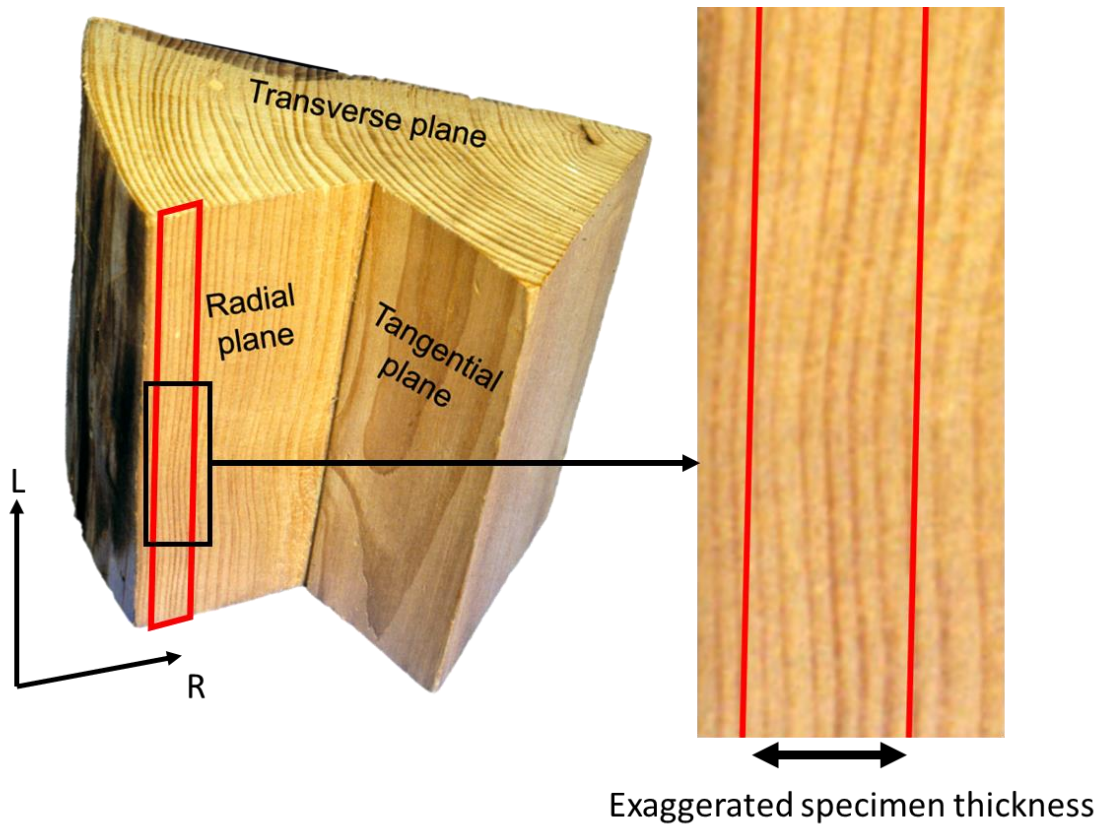

693

694

**Figure 6 – An exaggerated representation of veneer LR plane on a wood log [74]**

695

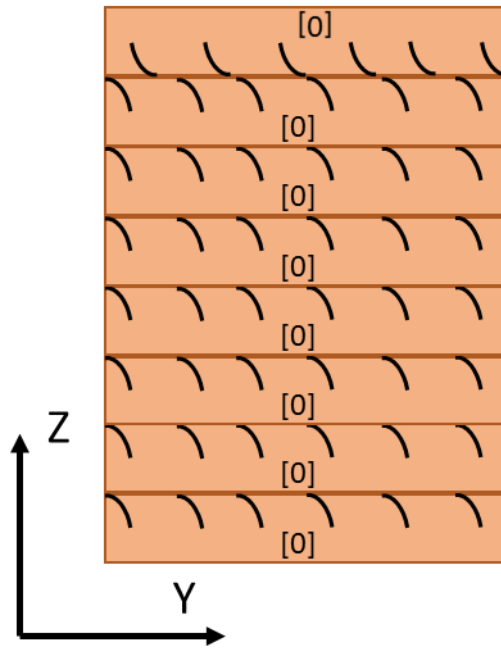

696

697

Figure 7- Stacking of the veneer of DCB 0°/0° specimens

698

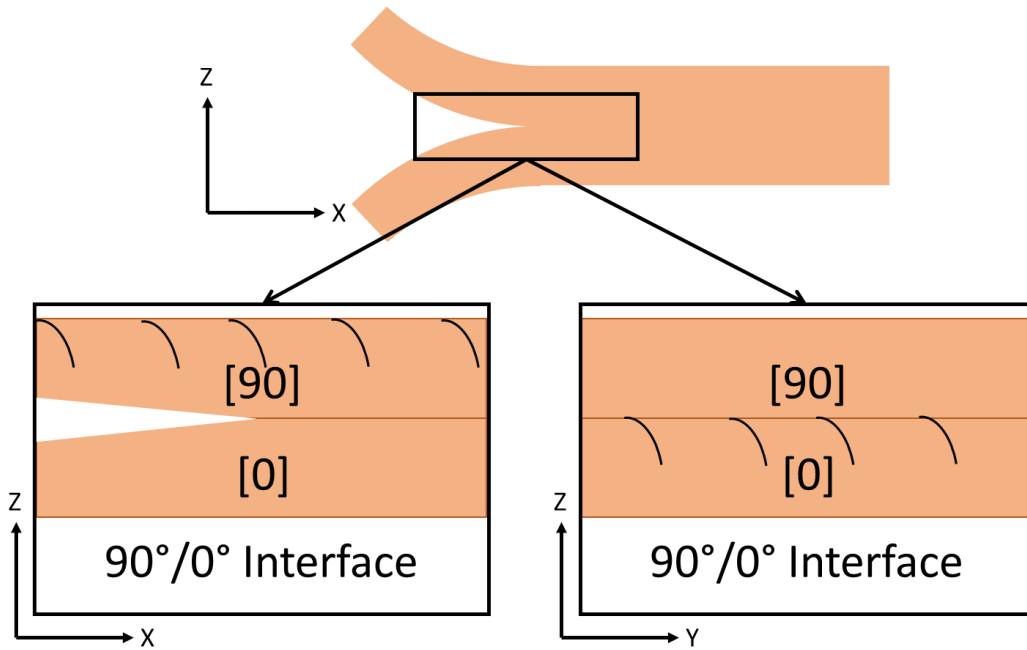

699

700

Figure 8- Stacking of the veneer at the interface of DCB 0°/90° specimens

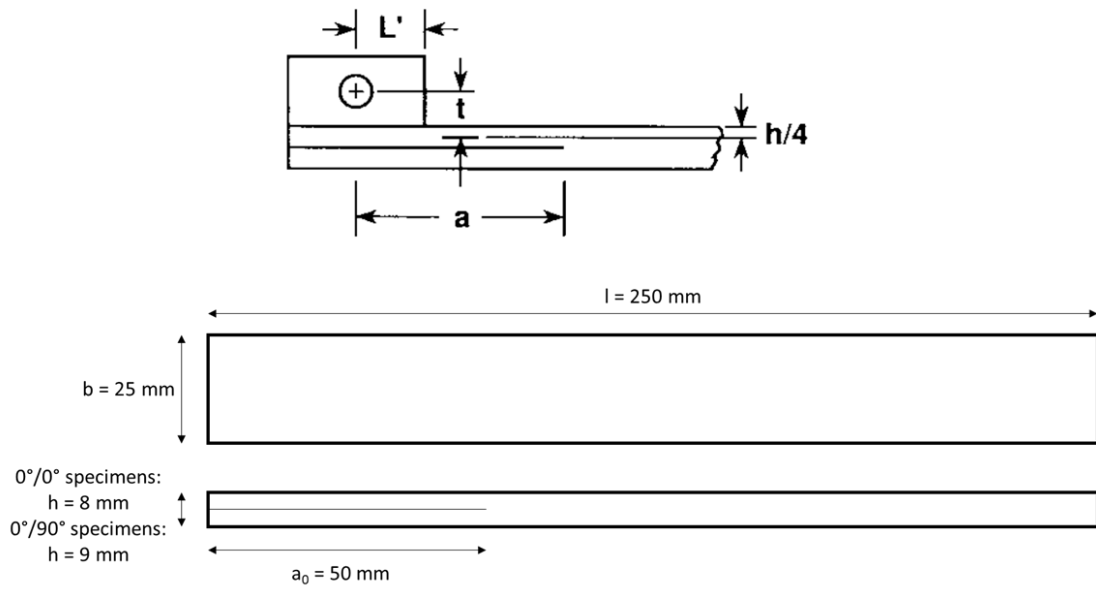

701

702

**Figure 9- DCB specimen shape used in the experiments**

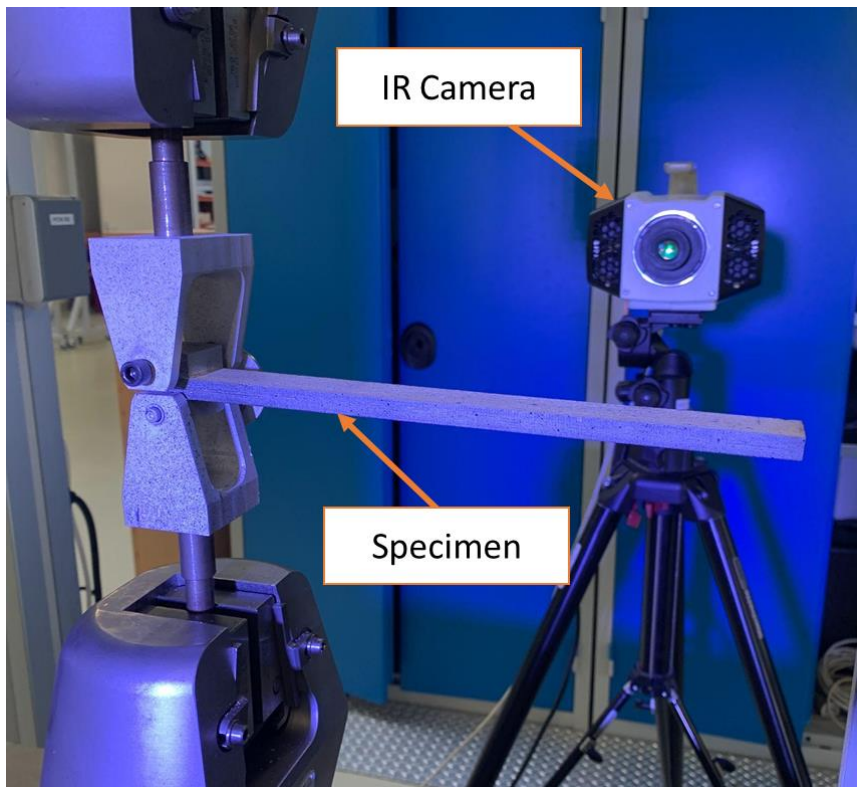

703

704

**Figure 10- Experimental Setup used during the DCB test**



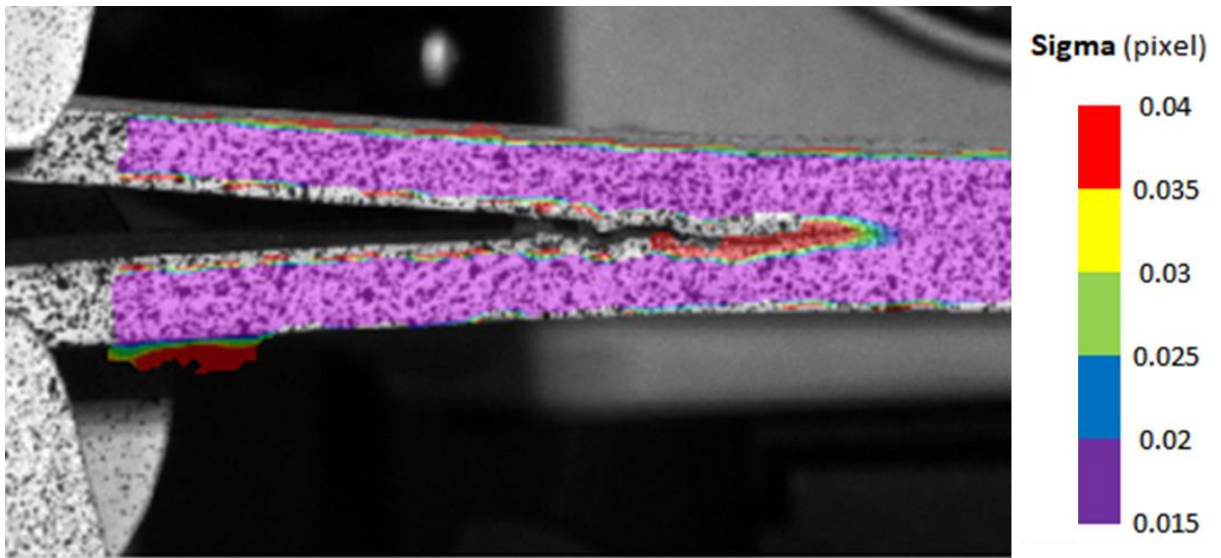

705

706

Figure 11 – Sigma visualization for one 0°/90° specimen (Colored figure)

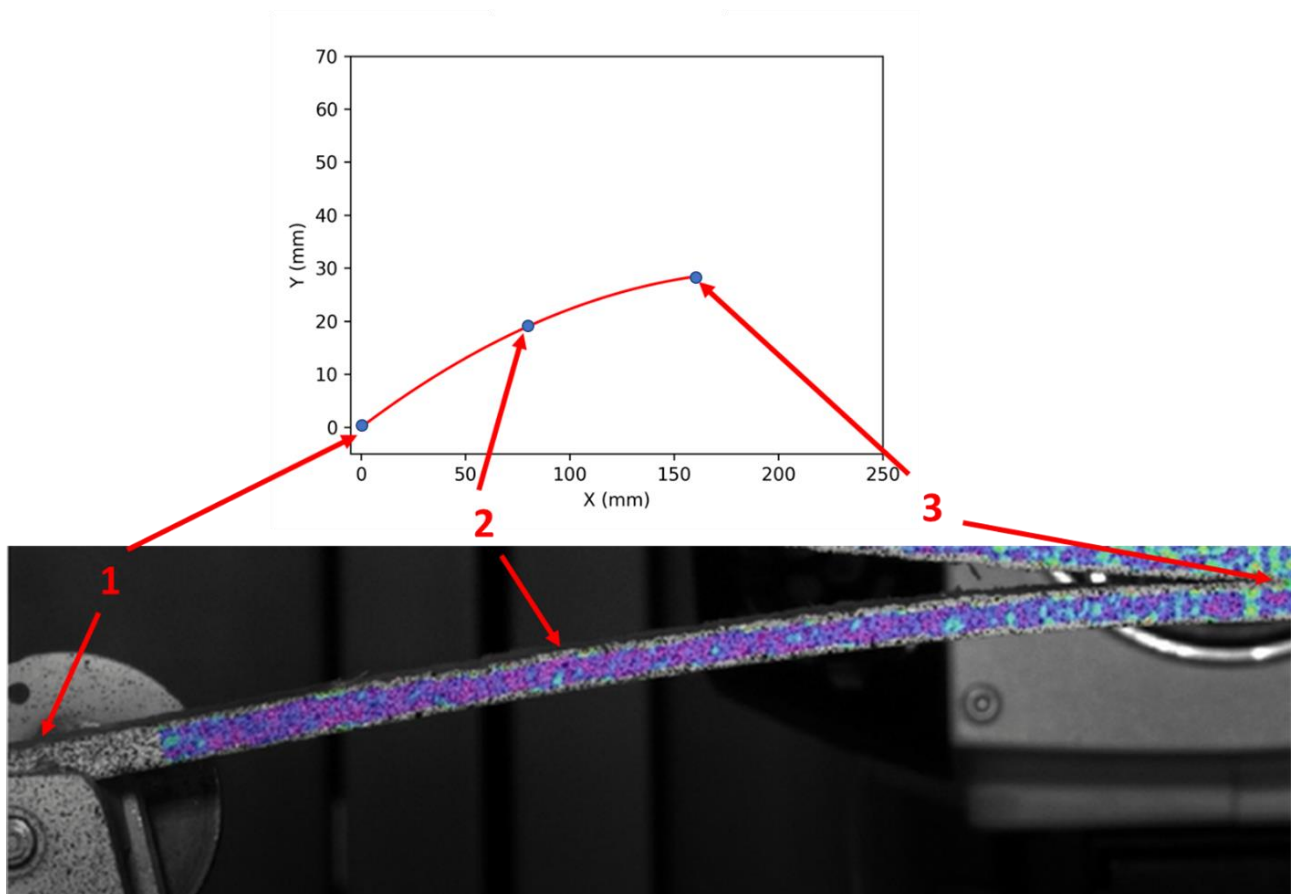

707

708

Figure 12 – Three-point interpolation used to obtain the crack length (Colored figure)



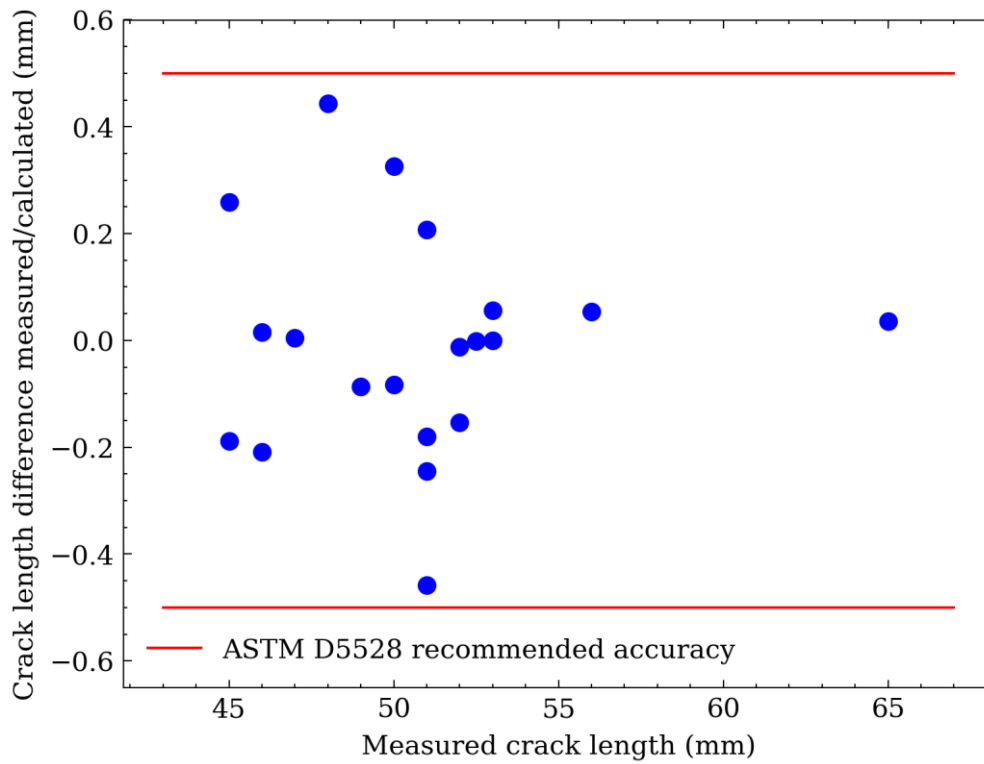

709

710

**Figure 13 – Difference between measured and calculated initial crack length**



711

712

**Figure 14 – Illustration of the crack path leaving the interfacial  $0^\circ/0^\circ$  due to fiber out-of-plane**

713

**angle**

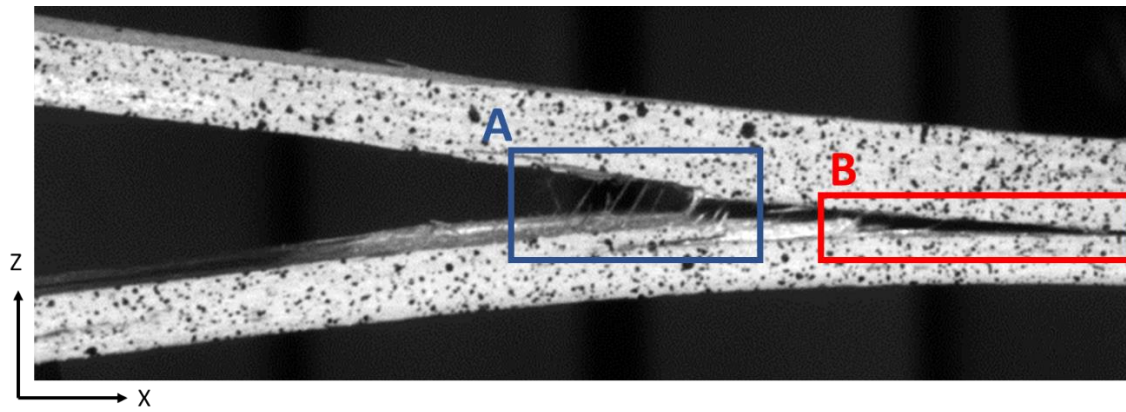

714

715

716

**Figure 15 – Post-mortem of specimen  $0^{\circ}/0^{\circ}$  no. 4 with fiber bridging (A) and crack that has migrated out of the initial interface (B)**

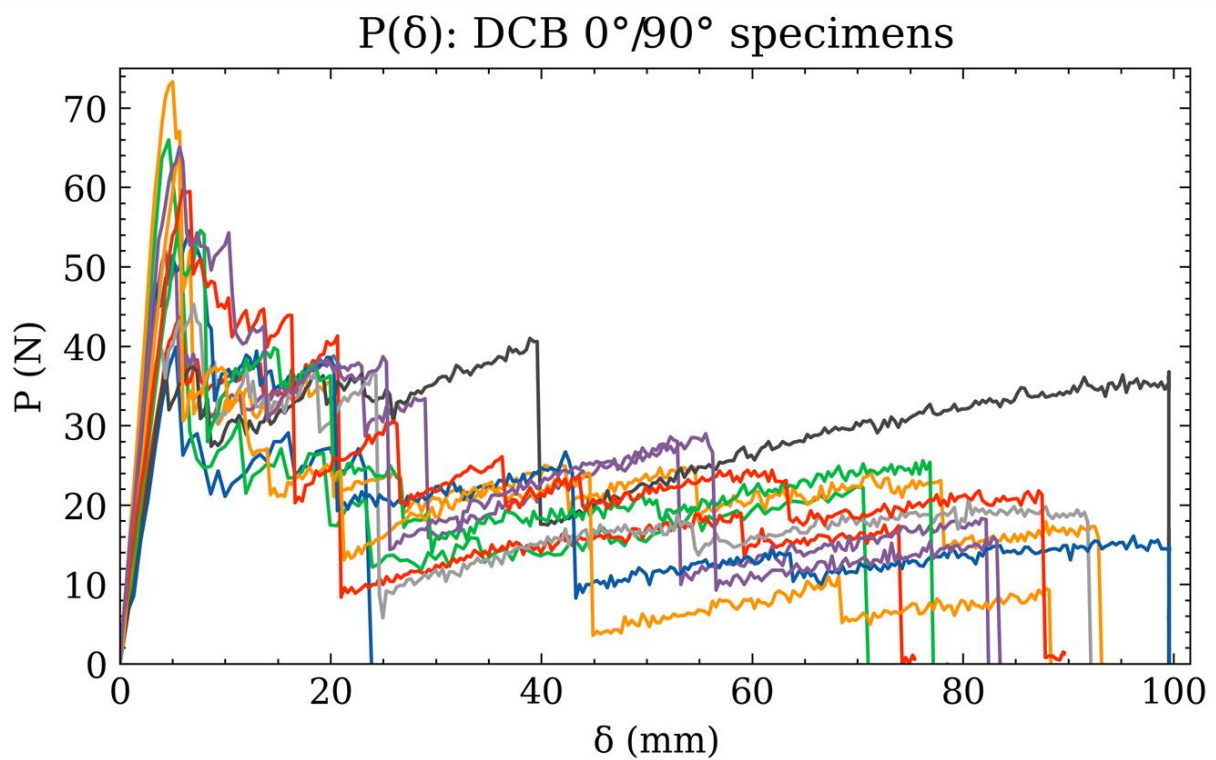
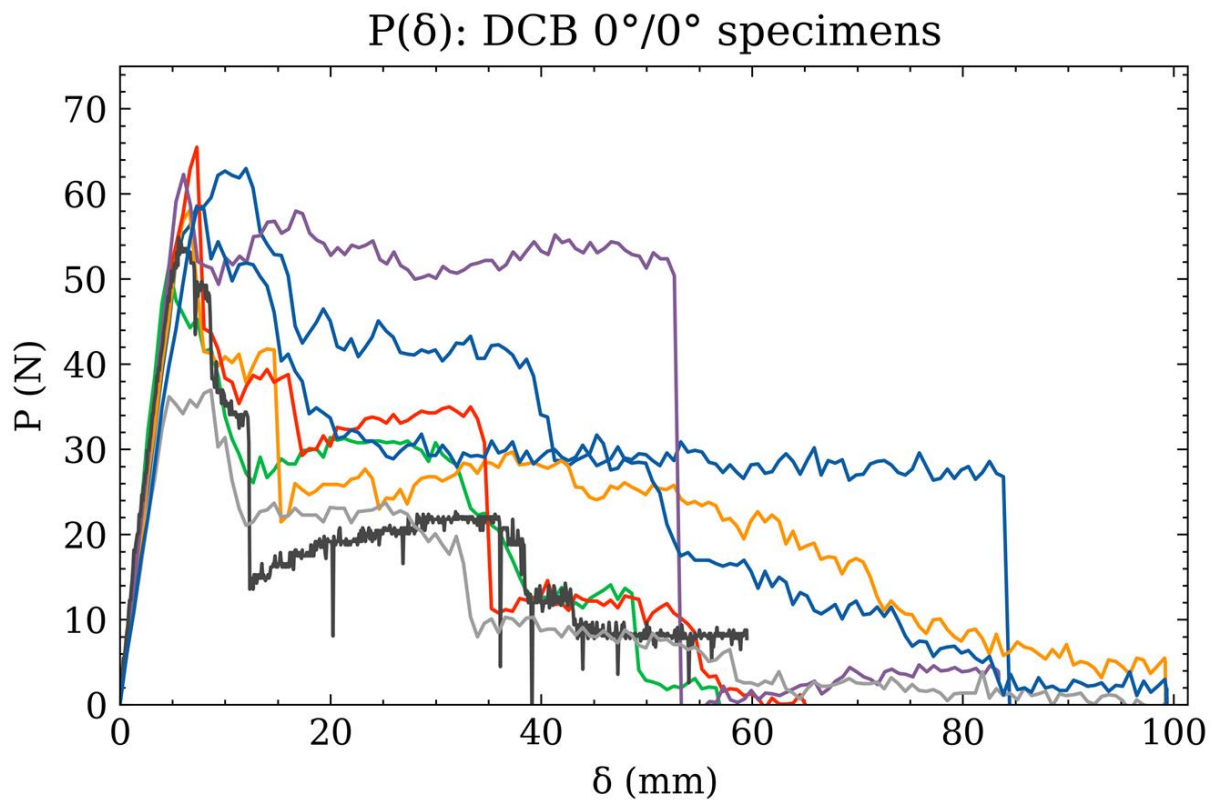

717

718

**Figure 16-  $P$ - $\delta$  curves for  $0^\circ/0^\circ$  specimens (top) and  $0^\circ/90^\circ$  specimens (bottom)**

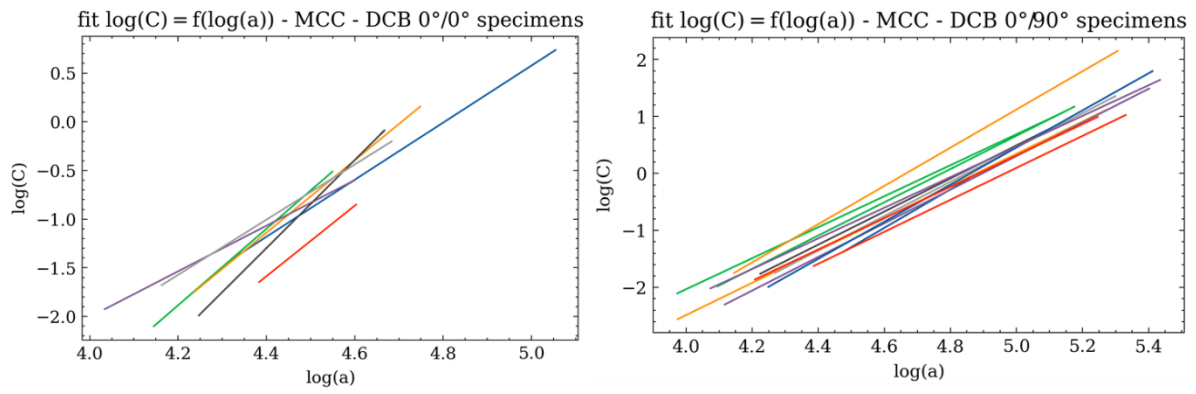

719

720 **Figure 17 – Fit calibration with MCC method for 0°/0° specimens (left) and 0°/90° specimens**

721

**(right)**

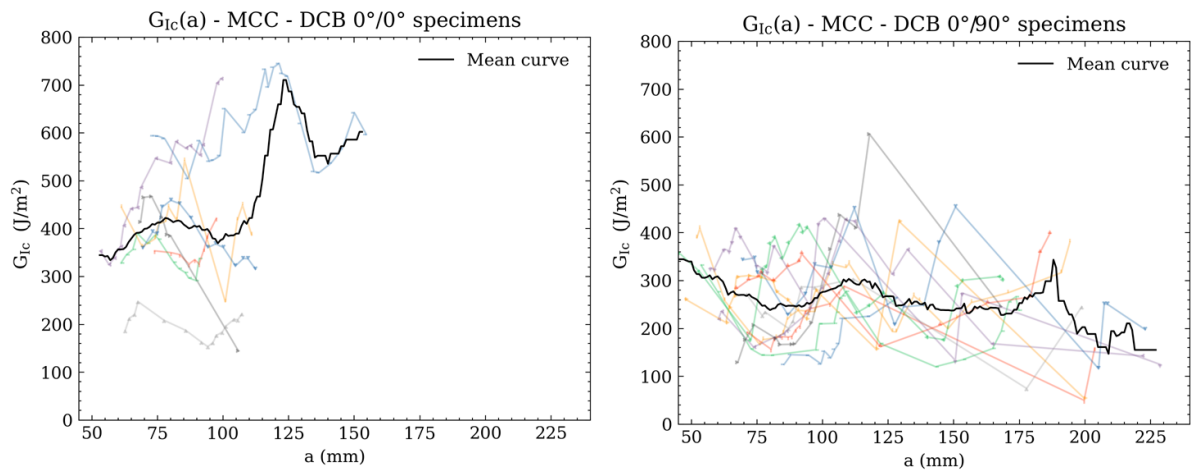

722

723 **Figure 18 – R-curves for 0°/0° specimens (left) and 0°/90° specimens (right) with the mean curve**

724

**(20-point rolling mean)**



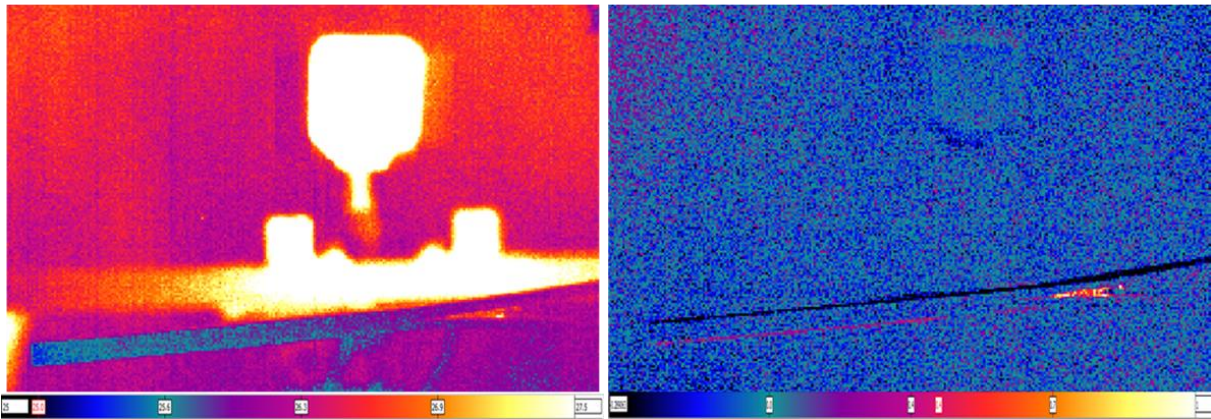
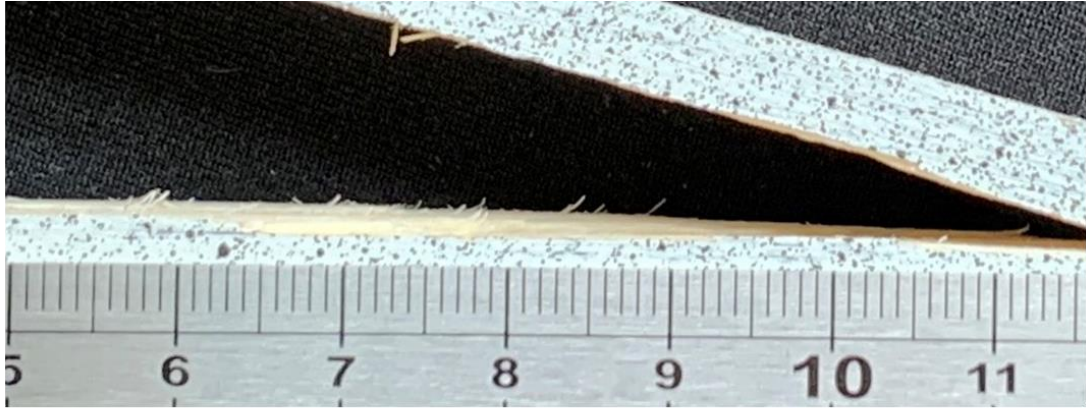

725

726

727

**Figure 19 – Close-up view of broken fiber (top), IR camera capture (bottom left) and the difference between two consecutive images (bottom right)**

728

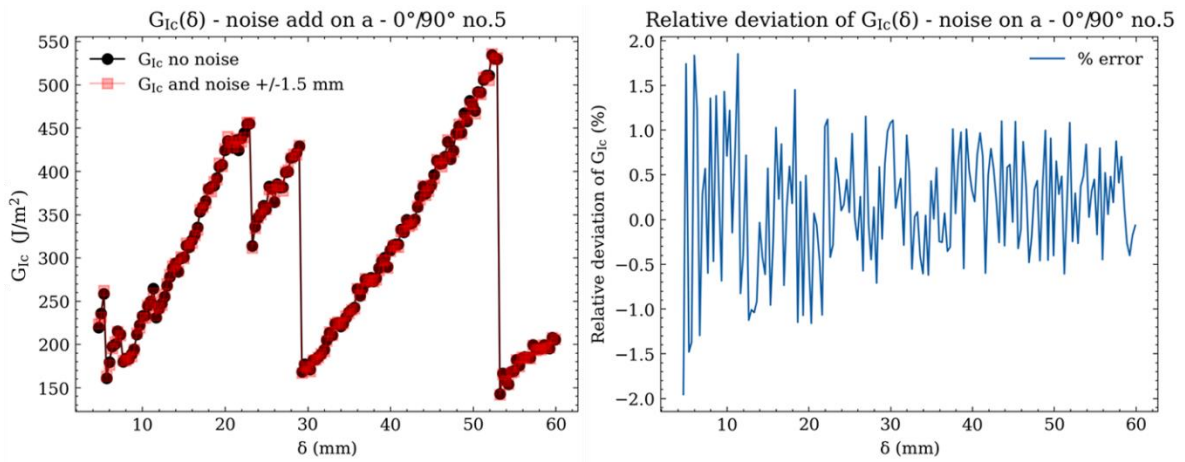

729

730

731

732

**Figure 20 – G<sub>Ic</sub> with and without noise added to the crack length measurement (left) and relative difference between G<sub>Ic</sub> with and without noise added to the crack length measurement (right) on specimen 0°/90° no. 5**

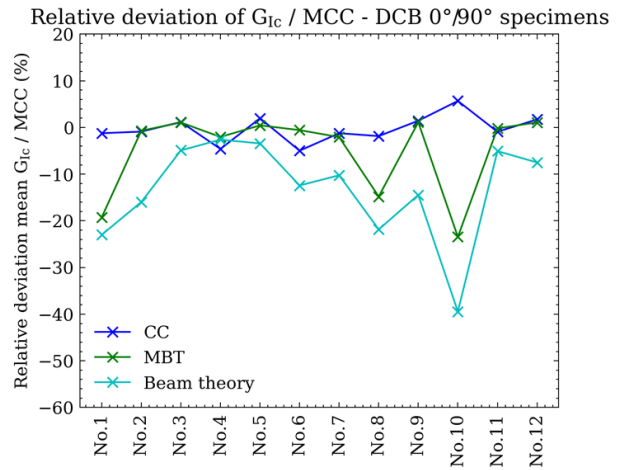
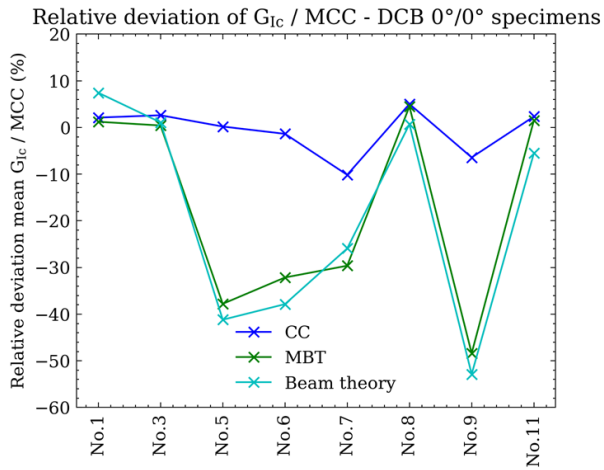

733

734

**Figure 21 – Relative deviation of  $G_{Ic}$  methods compared to the MCC method for  $0^\circ/0^\circ$  specimens**

735

**(left) and  $0^\circ/90^\circ$  specimens (right)**

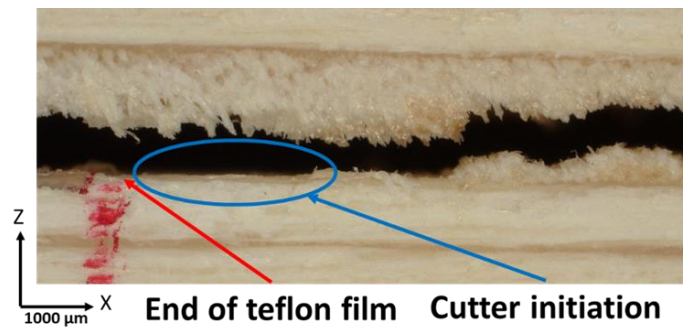

**Glued interfaces**



736

737

**Figure 22 – Initiation and intra-ply migration (top)  $90^\circ$  ply; intra-ply crack propagation in**

738

**$0^\circ/90^\circ$  specimen (bottom)**

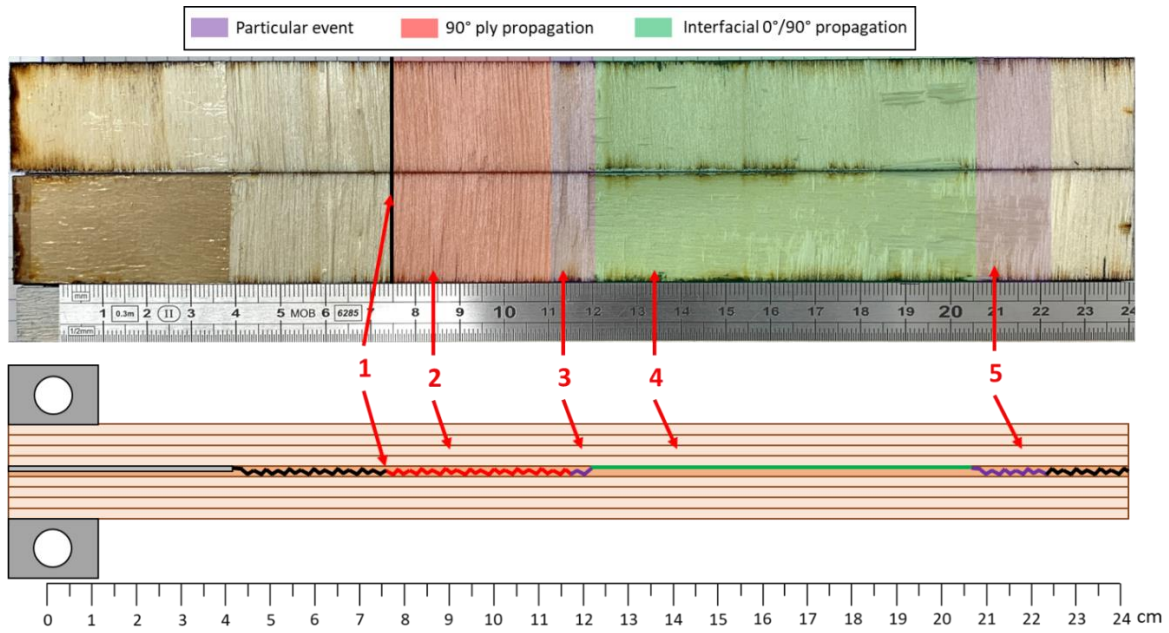

739

740

741

742

**Figure 23 – Post-mortem examination of upper and lower interfaces of specimen 0°/90° no. 4 with identification of propagation zones (top) and illustration of the crack path and propagation zones through the same specimen (bottom) (Colored figure)**

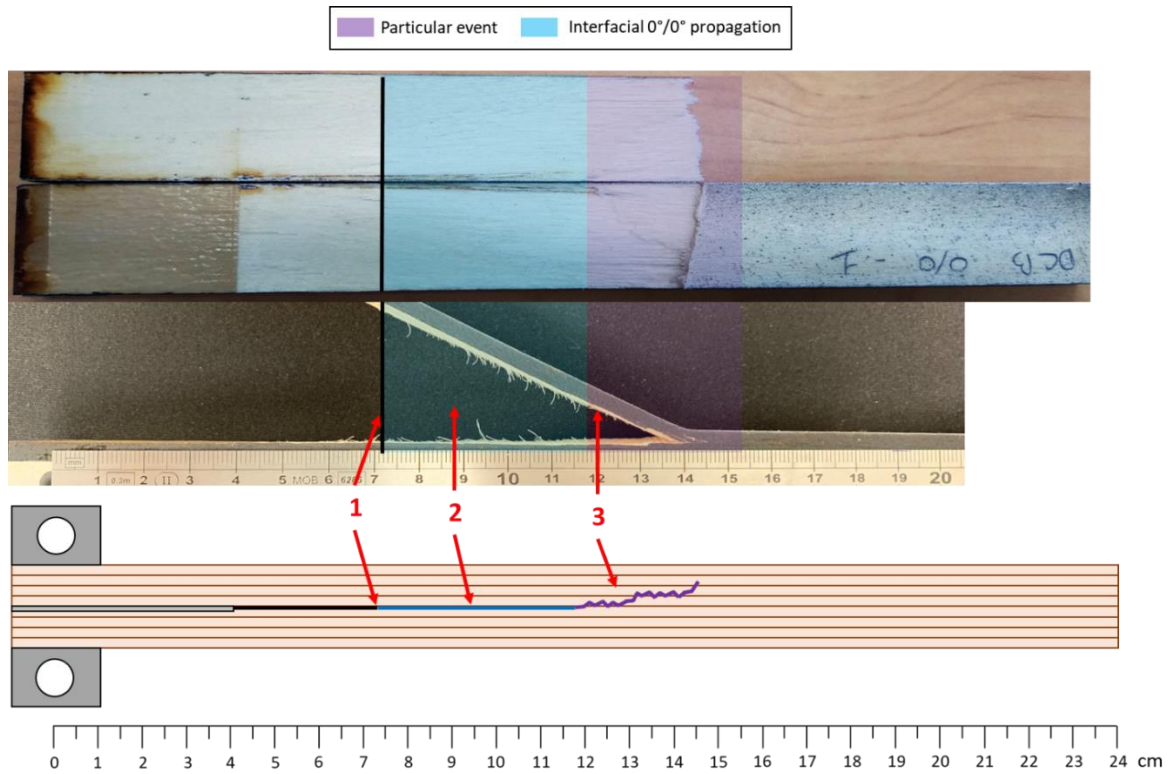

743

744 **Figure 24 – Propagation zones (top) and illustration of the crack path (bottom) for the specimen**

745

**0°/0° no. 1 (Colored figure)**

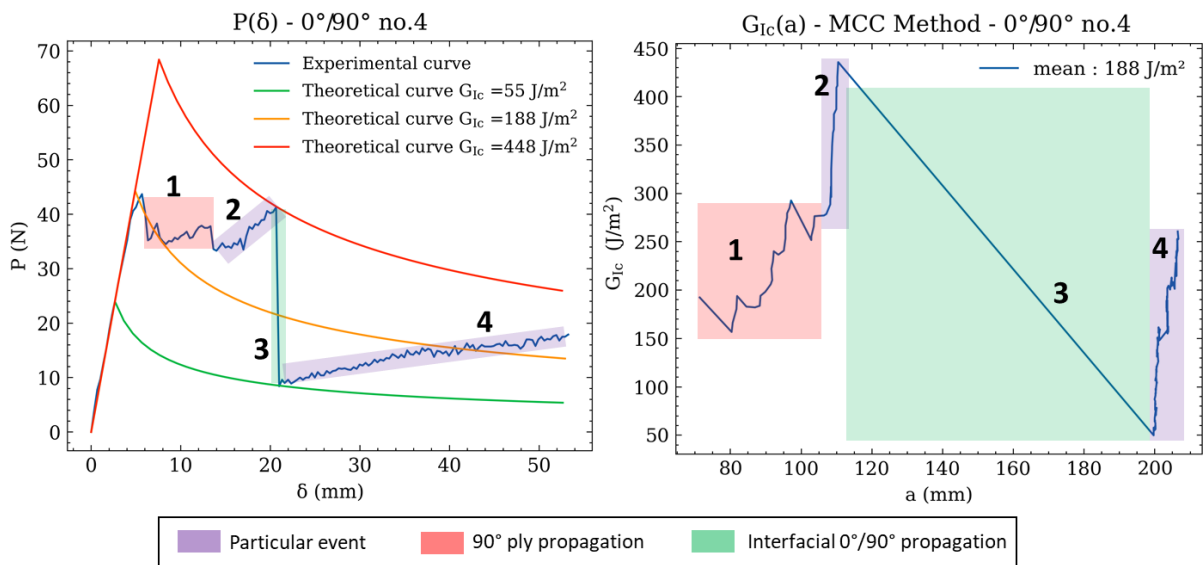

746

747 **Figure 25 – Experimental and theoretical P-δ curves (left) and R-Curve (right) for the specimen**

748

**0°/90° no. 4 (Colored figure)**



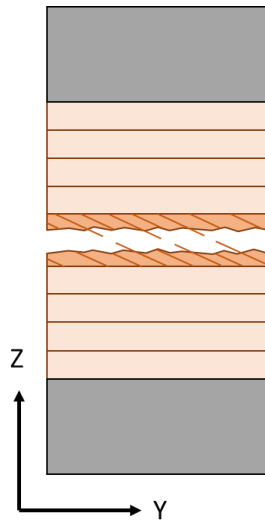

749

750

**Figure 26 – Out-of-plane fiber bridging on 0°/90° specimens**

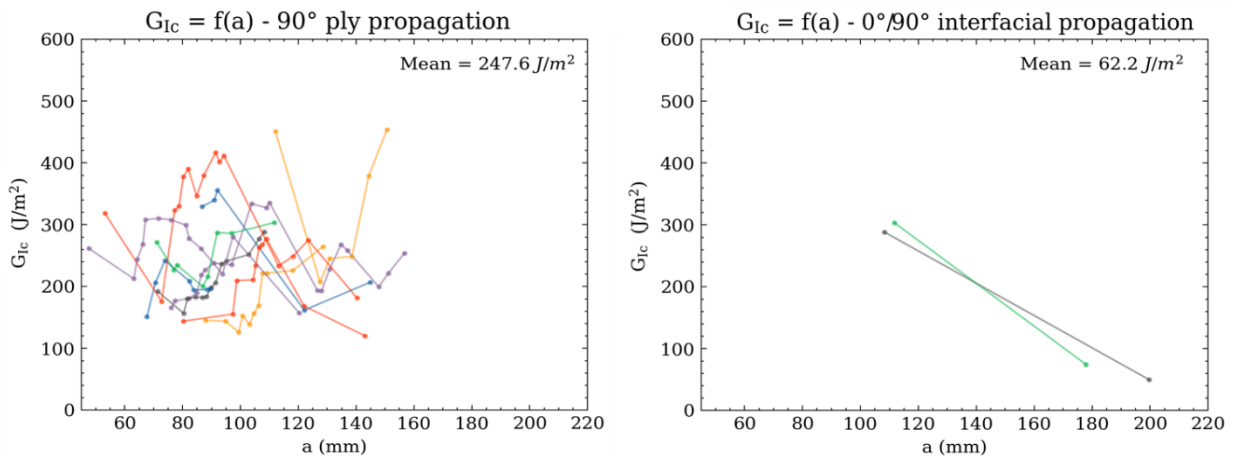

751

752

**Figure 27 –  $G_{Ic}=f(a)$  by propagation zones for 0°/90° specimens**

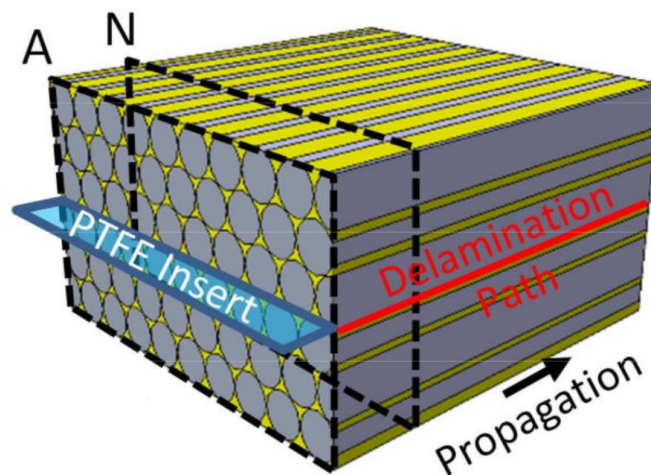

753

754

**Figure 28 – Expected delamination path for a 0°/0° interface [50] (Colored figure)**

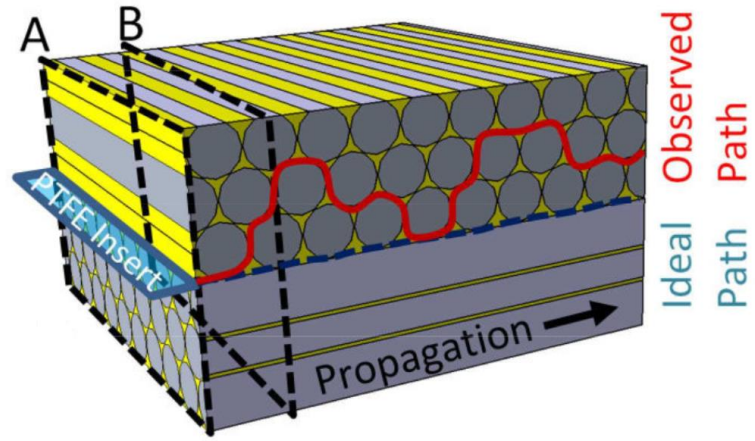

755

756

Figure 29 – Expected delamination path for a  $0^\circ/90^\circ$  interface [50] (Colored figure)

757

**Conflict of Interest Form**

758 The authors declare that they have no known competing financial interests or personal relationships  
759 that could have appeared to influence the work reported in this paper.