

ESAS'2023 School - Col de Porte, France

# Superconducting wind turbine generators

## Current status & perspectives

Loïc Quéval

<sup>1</sup> University of Paris-Saclay, CentraleSupélec, CNRS, Group of electrical engineering - Paris, 91192, Gif-sur-Yvette, France

<sup>2</sup> Sorbonne University, CNRS, Group of electrical engineering - Paris, 75252, Paris, France

# Content

- I. Resource and potential
- II. Wind energy conversion system
- III. Superconducting wind turbine generators ?
- IV. Current status and perspectives

# I. Resource and potential

# World electricity generation

« What we need » following IEA Stated Policies Scenario

	2018	2040
Total generation [TWh <sub>e</sub> / year]	26 603	<b>41 373</b>

# Resource and potential

Primary resource:  
30 000 000 TWh<sub>p</sub> / year

Technical potential:  
420 000 TWh<sub>e</sub> / year

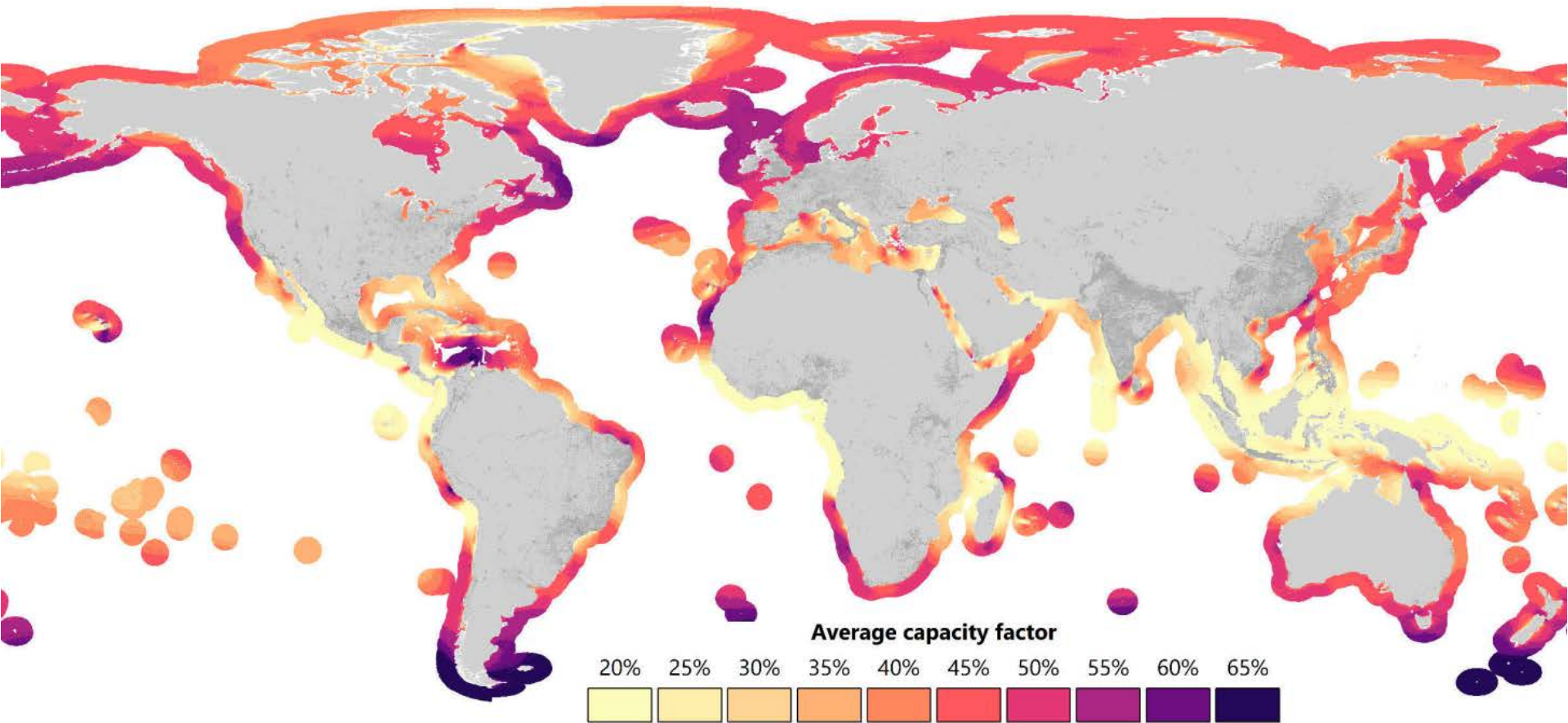

# Resource and potential

*Dunkerqk  
44 €/MWh*



	Near to shore (20 - 60 km)	Far from shore (60 - 300 km)
Shallow water (< 60 m)	36 000 TWh <sub>e</sub> / year	51 000 TWh <sub>e</sub> / year
Deep water (60 - 2 000 m)	76 000 TWh <sub>e</sub> / year	254 000 TWh <sub>e</sub> / year

## II. Wind Energy Conversion System (WECS)

# Wind energy conversion system

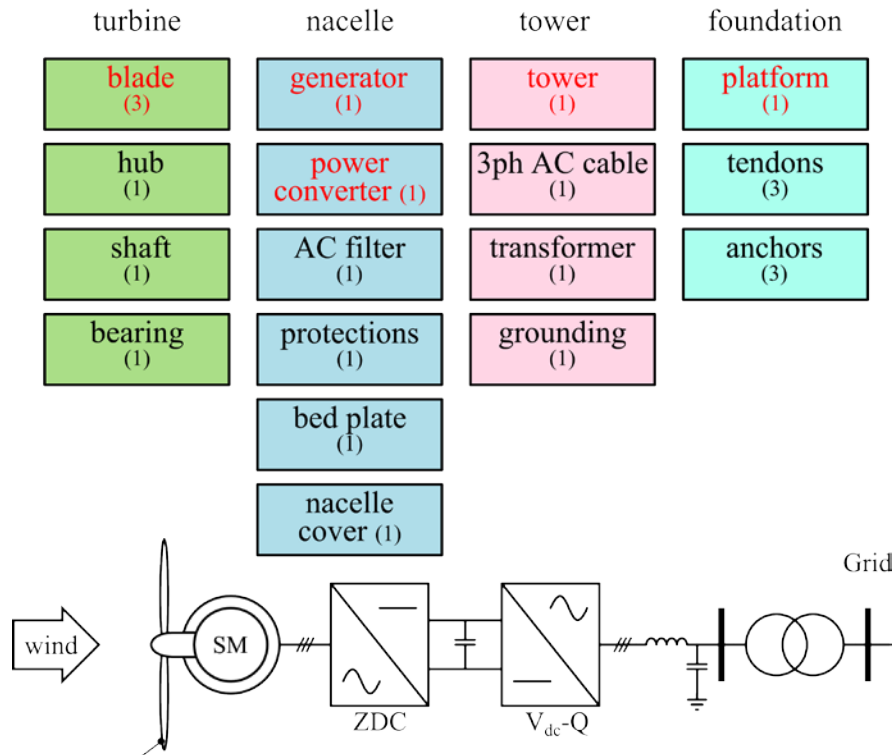



# LCOE breakdown of offshore windfarm

## Costs of a reference fixed-bottom offshore wind farm

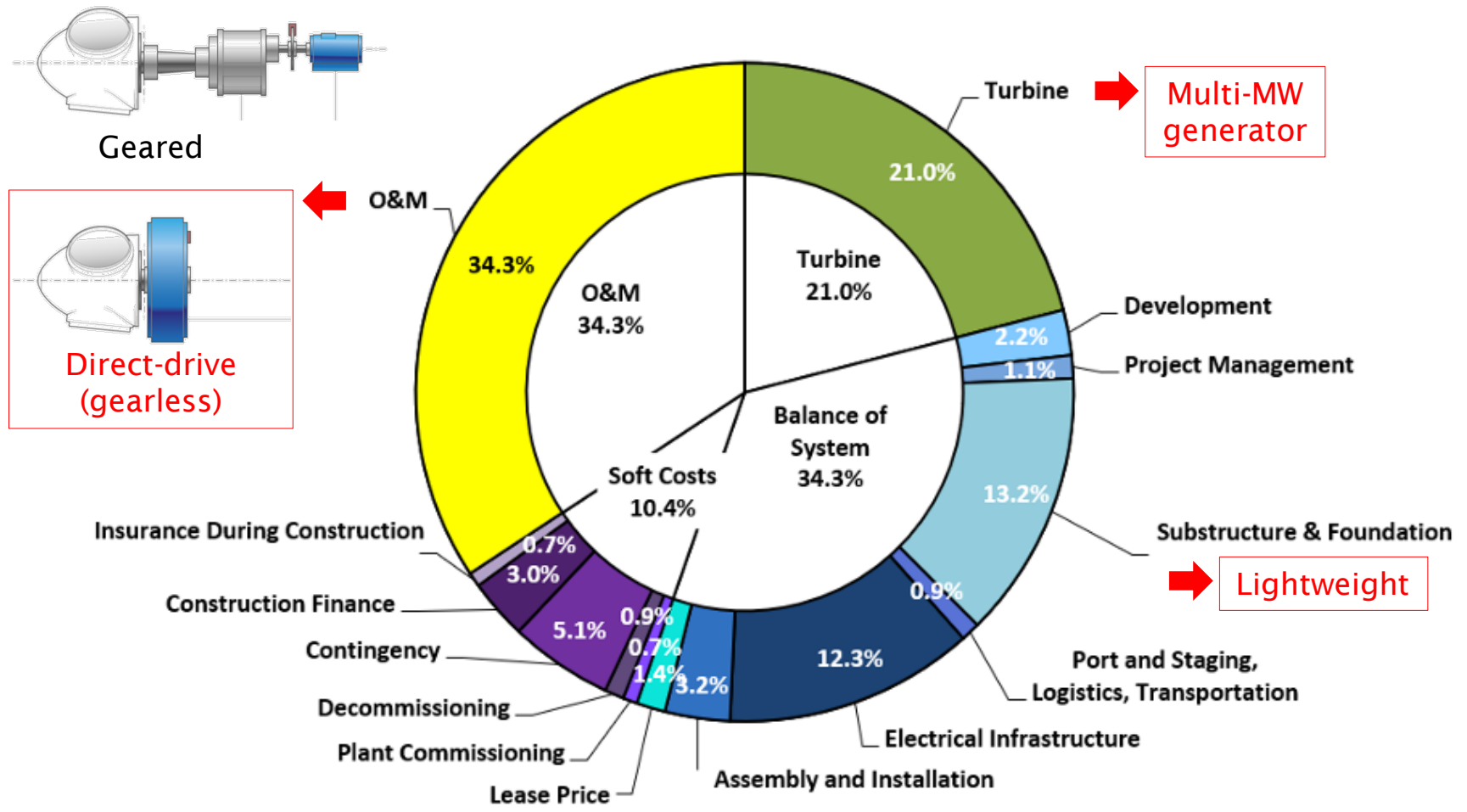

Multi-MW generator

Direct-drive (gearless)

Lightweight

[1] T. Stehly, P. Beiter and P. Duffy, "2019 Cost of Wind Energy Review," National Renewable Energy Laboratory (NREL), 2020.

# Unit power

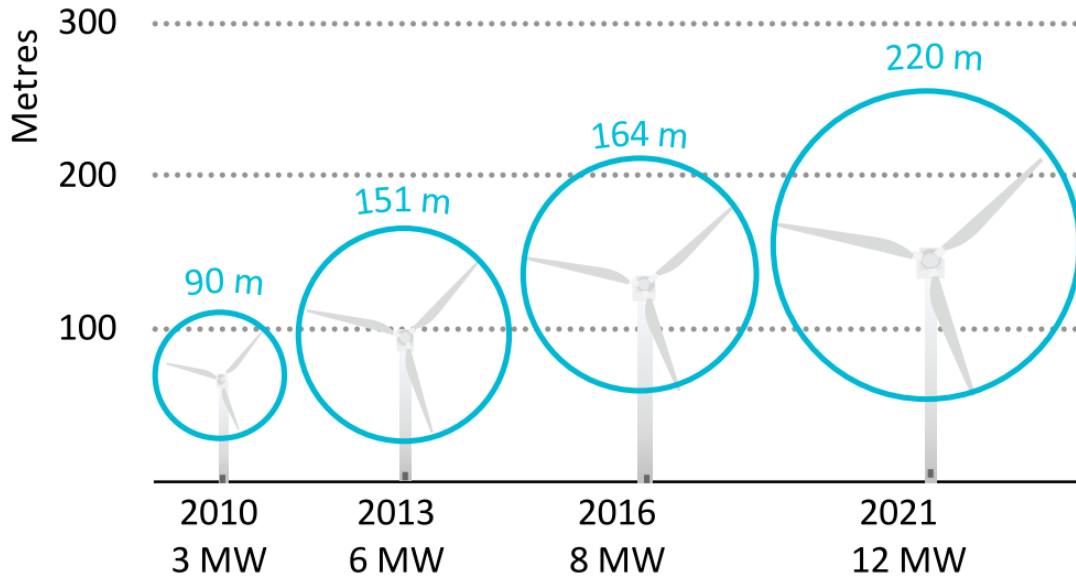

World's largest wind turbine generator  
**Vestas V236-15.0 MW** →



# Unit power

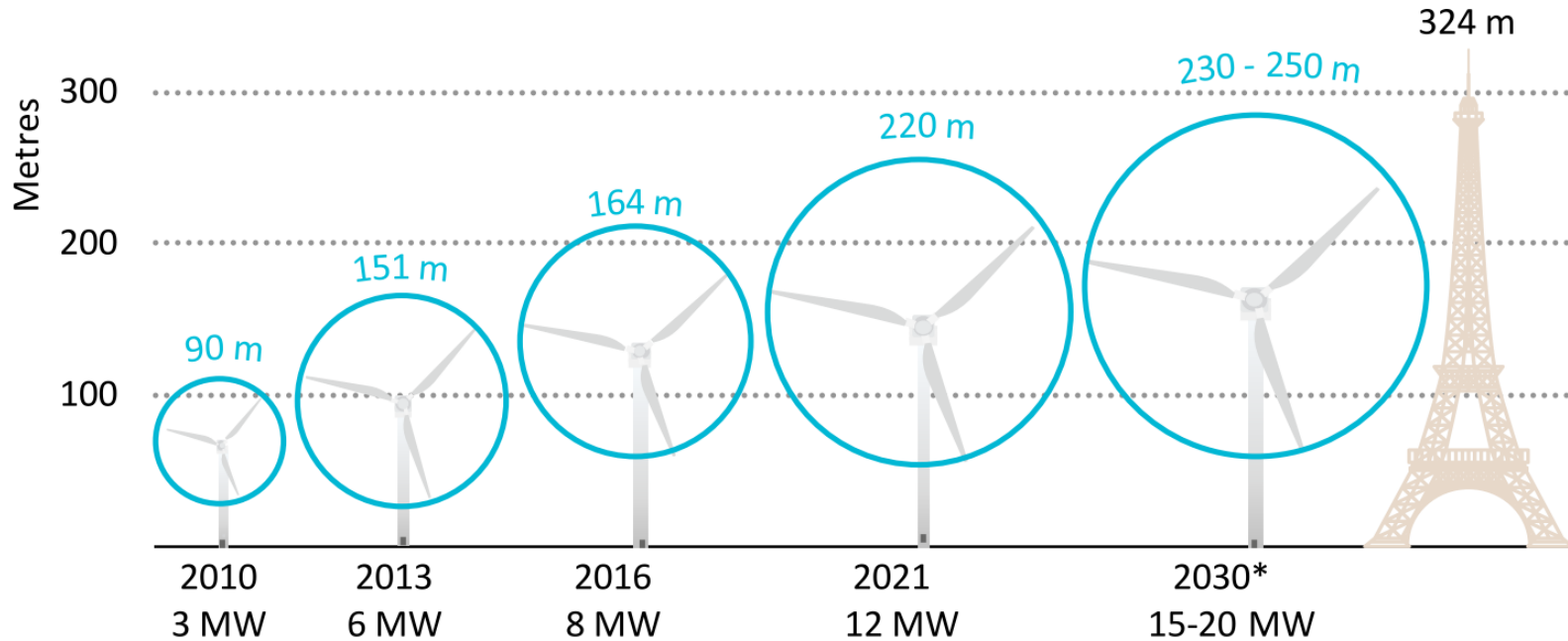

Towards 20 MW offshore wind turbines !

**GE Haliade-X 18 MW**

**MingYang Smart Energy MySE 18.X-28X**

**CSSC Haizhuang H260-18MW**

...



# Wind turbine generator

## Synchronous generator



**EESG in Enercon  
E-138 EP3 4.2 MW**



**EESG in Enercon  
E-126- 7.5 MW**

## **III. Superconducting wind turbine generator ?**

# Comparison 20 MW DD PMSG vs. Fully HTS SG

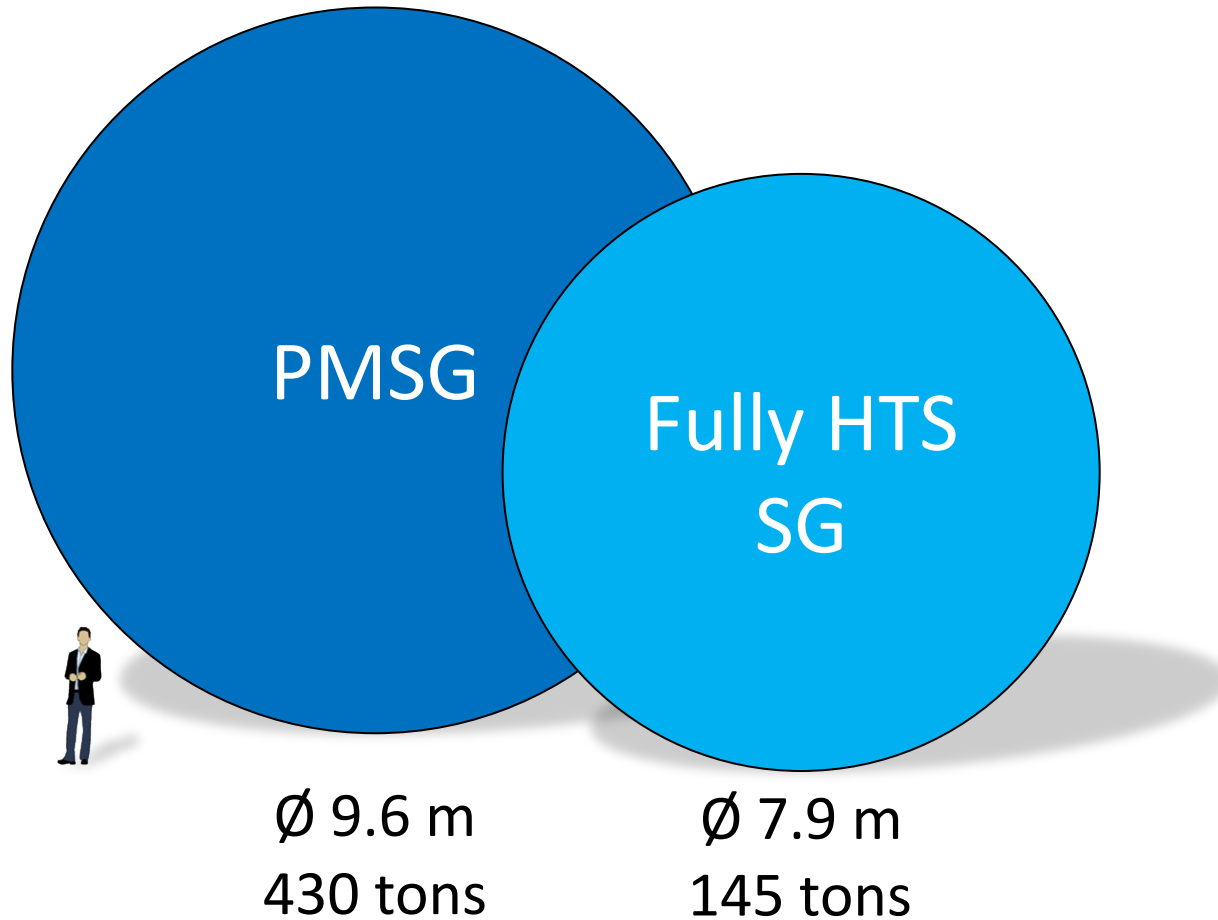

[1] T.-K. Hoang, L. Quéval, L. Vido, D.-Q. Nguyen, "Levelized cost of energy comparison between permanent magnet and superconducting wind generators for various nominal power," *IEEE Transactions on Applied Superconductivity*, vol. 32, no. 7, id. 5202606, Oct. 2022.

# Comparison 10 MW DD PMSG vs. HTS SG

10 years ago. WRONG!

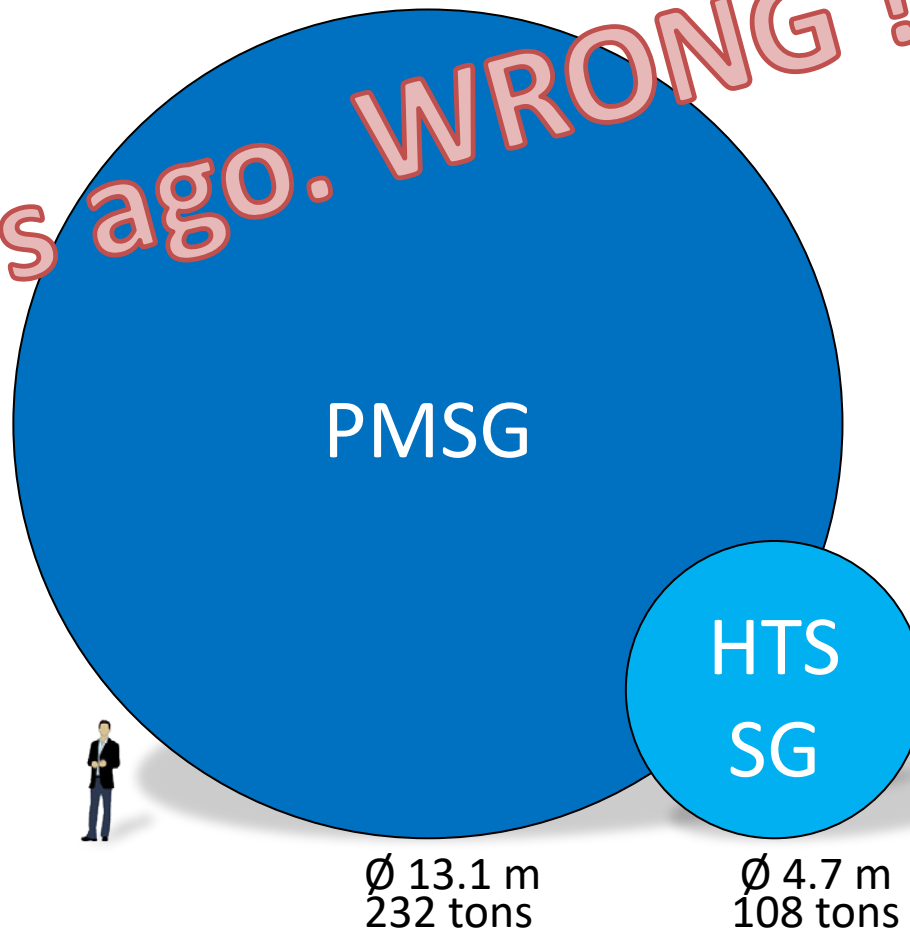

[1] L. Quéval, "Modeling and simulation of grid-connected superconducting wind turbine generators," PhD thesis, The University of Tokyo, Tokyo, Japan, 2013. Online: [www.lqueval.com](http://www.lqueval.com)

# Superconducting wind turbine generators ?

## #1 - Technical reason

Conventional technologies do not meet the constraints of size and weight for the next generation >20 MW direct-drive wind turbine generators that will be installed on offshore floating platforms?

## #2 - Techno-economic reason

WECS with superconducting machines have the potential to be more competitive than conventional machines?



# Impact of a modification of the generator ?

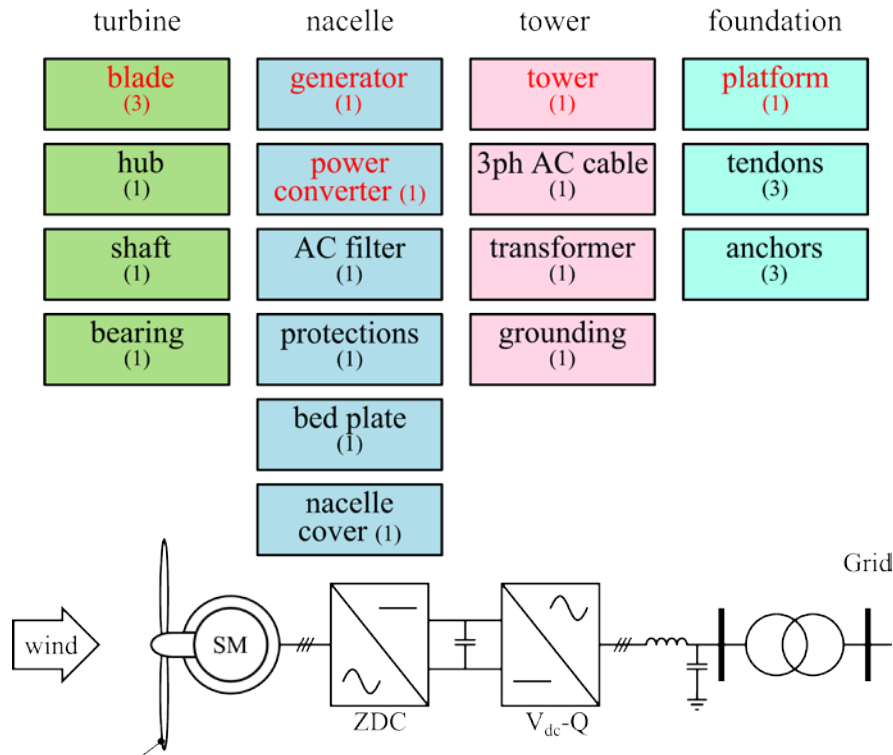

# Techno-economic assessment

**Goal:** WECS PM generator **vs.** WECS HTS generator

**Scenario:**

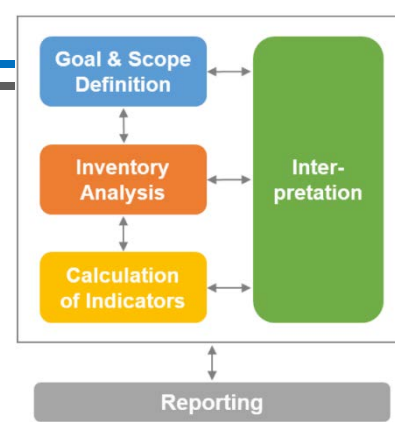
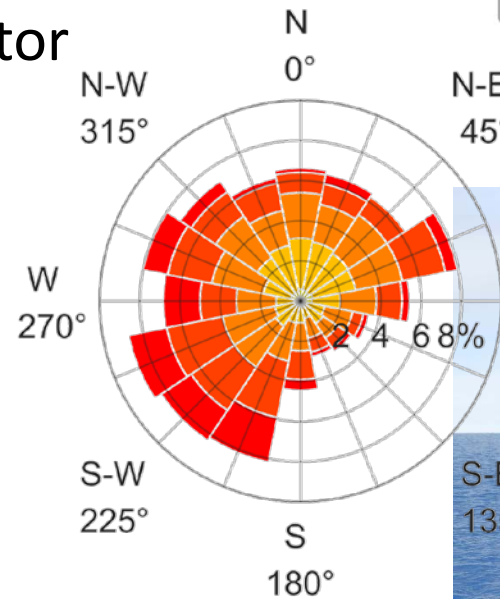
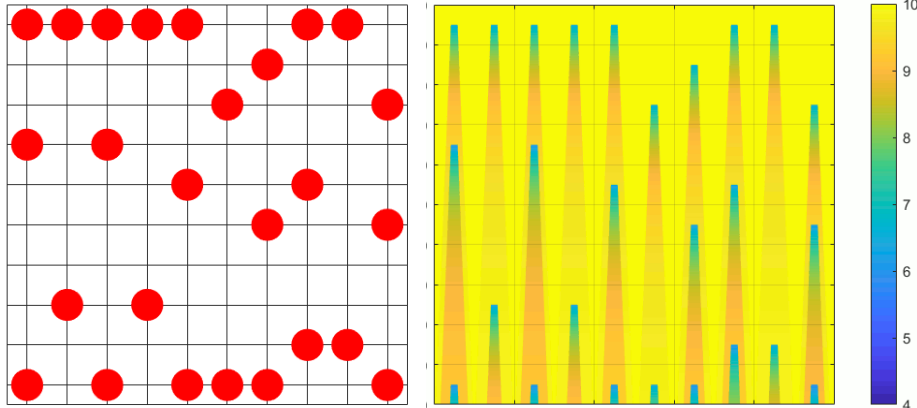

**Performance indicator: LCOE [€/MWh]**

# Superconducting wind turbine generators ?

## #1 - Technical reason

Conventional technologies do not meet the constraints of size and weight for the next generation >20 MW direct-drive wind turbine generators that will be installed on offshore floating platforms?

## #2 - Techno-economic reason

Superconducting wind turbines will be more competitive than conventional machines?

## #3 - Geopolitical reason

Critical raw material act

# Critical raw material act

European Commission, March 16th, 2023

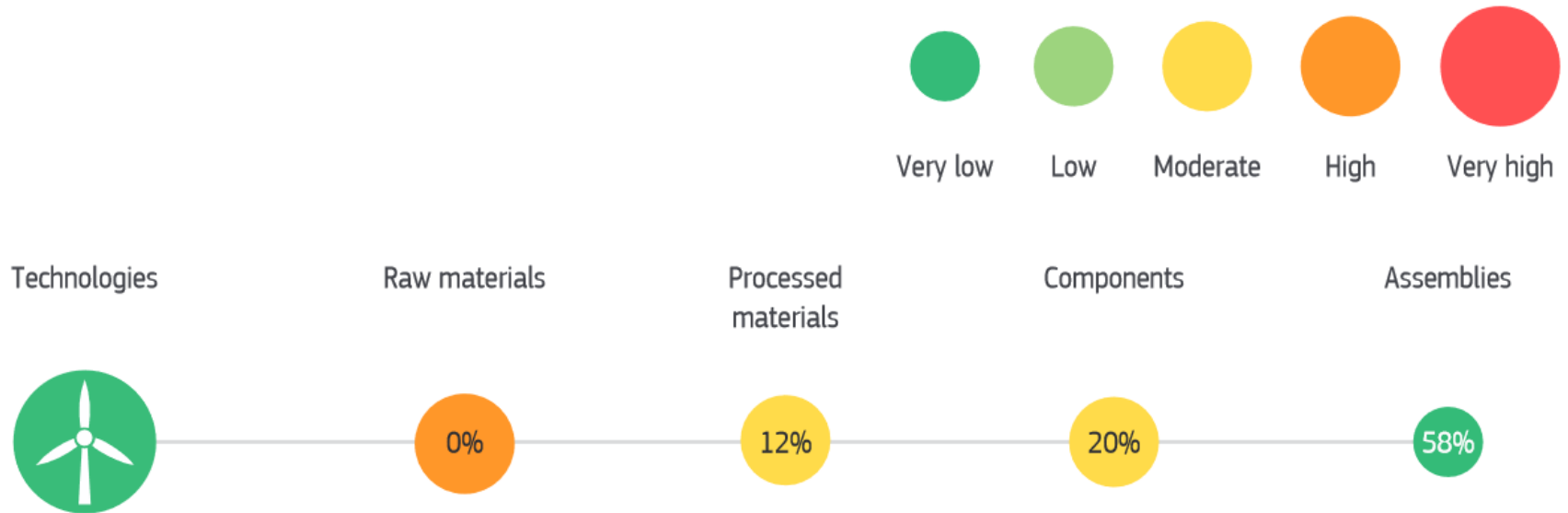

Identified supply risks for the EU and EU shares of production

## **IV. Current status and perspectives**

# Founding article

IOP PUBLISHING

SUPERCONDUCTOR SCIENCE AND TECHNOLOGY

 Supercond. Sci. Technol. **23** (2010) 034019 (8pp)

doi:10.1088/0953-2048/23/3/034019

# Superconducting wind turbine generators

A B Abrahamsen<sup>1</sup>, N Mijatovic<sup>2</sup>, E Seiler<sup>1</sup>, T Zirngibl<sup>1</sup>, C Træholt<sup>2</sup>,  
 P B Nørgård<sup>3</sup>, N F Pedersen<sup>2</sup>, N H Andersen<sup>1</sup> and J Østergård<sup>2</sup>

<sup>1</sup> Materials Research Division, Risø-DTU, Frederiksborgvej 399, 4000 Roskilde, Denmark

<sup>2</sup> Department of Electrical Engineering, Technical University of Denmark, DK-2800 Lyngby, Denmark

<sup>3</sup> Wind Energy Division, Risø-DTU, Frederiksborgvej 399, 4000 Roskilde, Denmark

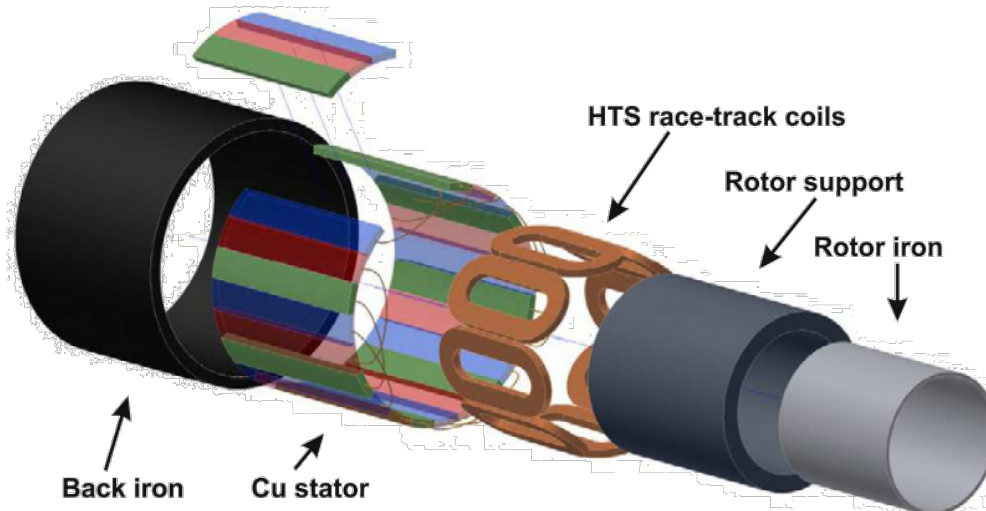

**Table 2.** Properties of an extreme 10 MW generator example.

Rated power $P_N$ (MW)	10
Poles	16
Diameter $D_{gen}$ (m)	4.7
Length $L_{gen}$ (m)	1.15
Rotation speed $\omega_{R,rpm}$ (rpm)	10
Shaft torque $\tau_T$ ( $10^6$ N m)	9.7
Mass superconductor $m_{sc}$ (ton)	22
Mass Cu $m_{Cu}$ (ton)	14
Mass Fe $m_{Fe}$ (ton)	32
Mass glass fiber $m_{GF}$ (ton)	20
Mass total (ton)	88
Length of SC (km)	1450
Current density $J_e$ ( $A\ m^{-2}$ )	$6.3 \times 10^7$
Temperature $T$ (K)	20
Maximum field $B_{max}$ (T)	9.1

# Design of partially SC WT generators (ironless)

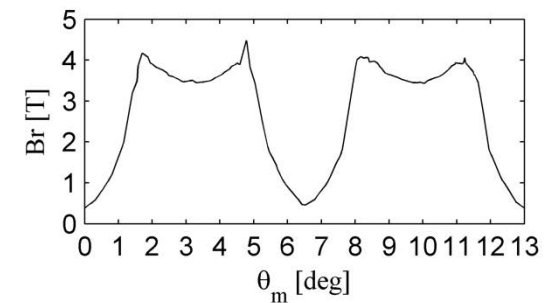
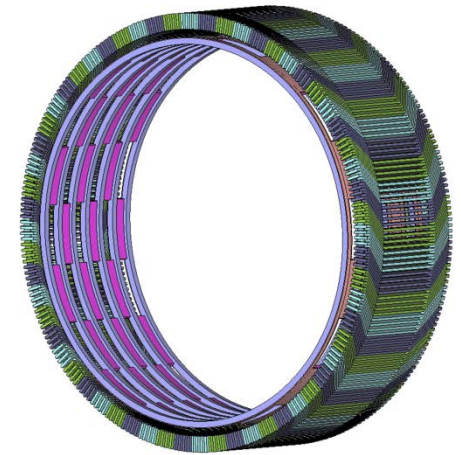
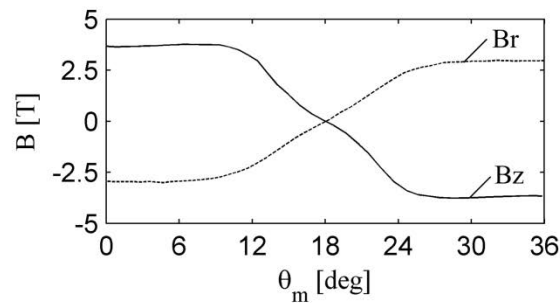
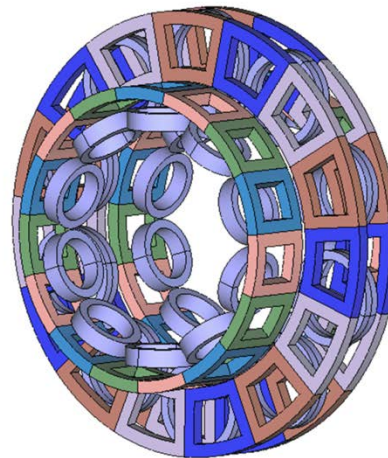
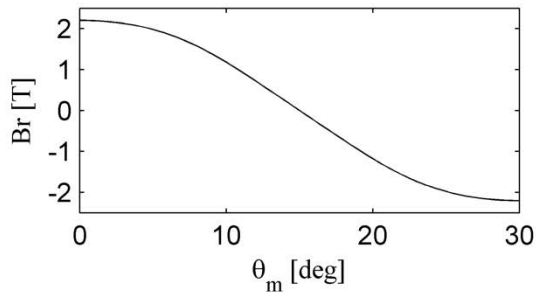
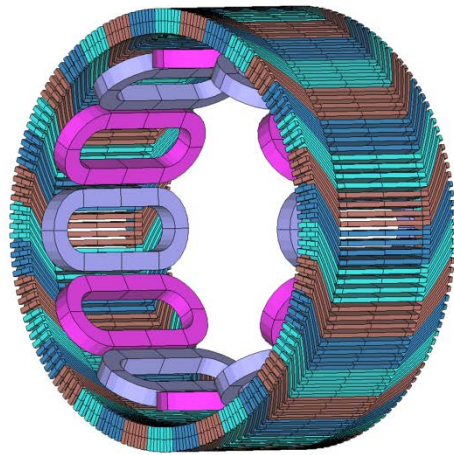

- [1] H. Ohsaki, Y. Terao, R. M. Quides, "Electromagnetic characteristics of 10 MW class superconducting wind turbine generators," *Int. Conf. on Electrical Machines and Systems*, pp. 1303-1306, 10-13 Oct 2010.
- [2] M. R. Quides, M. Sekino, H. Ohsaki, N. Kashima, S. Nagaya, "Electromagnetic Design Study of Transverse Flux Enhanced Type Superconducting Wind Turbine Generators," *IEEE Transactions on Applied Superconductivity*, vol. 21, no. 3, pp. 1101-1104, June 2011.
- [3] H. Ohsaki, Y. Terao, M. Sekino, "Wind turbine generator using superconducting coils and bulks," *J. Phys.: Conf. Ser.*, vol. 234, part. 3, 2010.

# Design of partially SC WT generators (with iron)

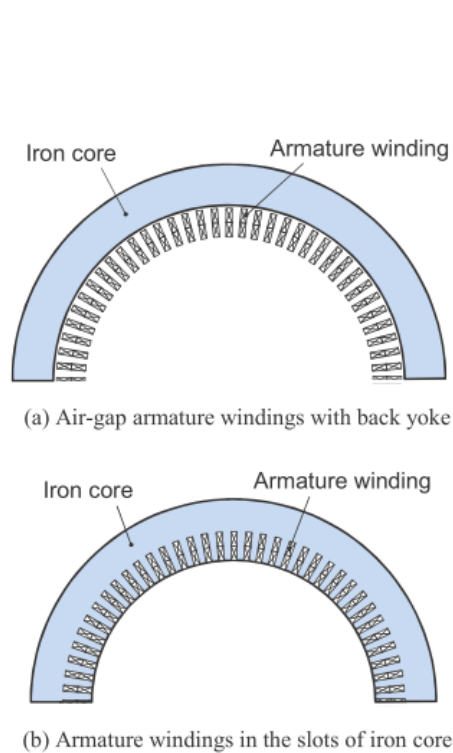

Fig. 4 Fundamental stator structures with armature windings.

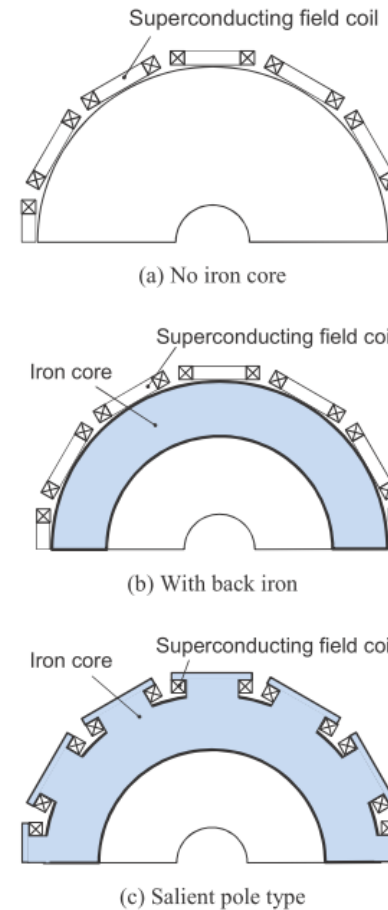

Fig. 5 Fundamental rotor structures with superconducting field coils.

[1] H. Ohsaki, L. Quéval, Y. Terao, "Design and characteristic analysis of 10 MW class superconducting wind turbine generators with different types of stator and rotor configurations," *4th International Conference on Clean Electrical Power (ICCEP 2013)*, Alghero, Italy, June 2013.



# Design of fully SC WT generators

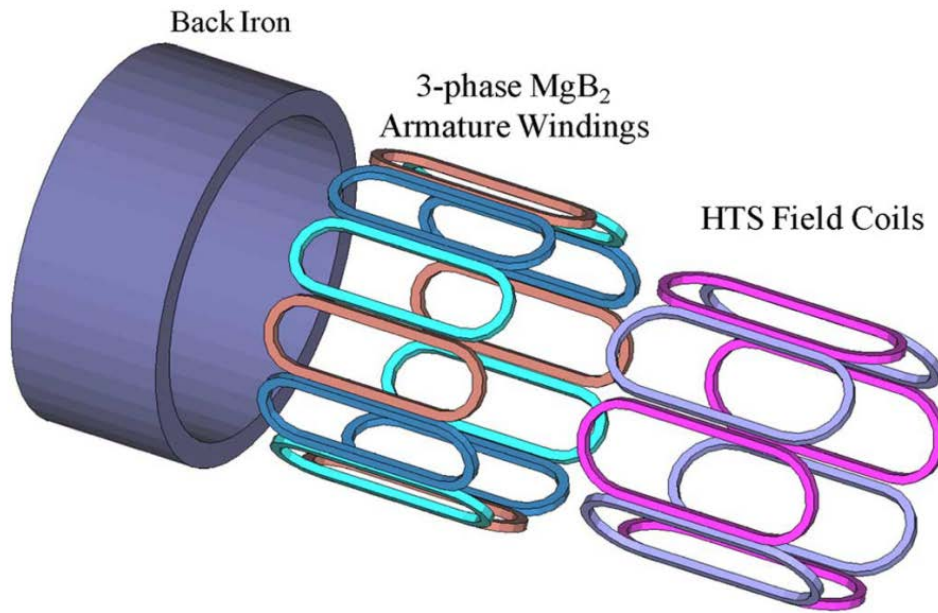

Fig. 1. Illustration of fully superconducting wind turbine generator [1]

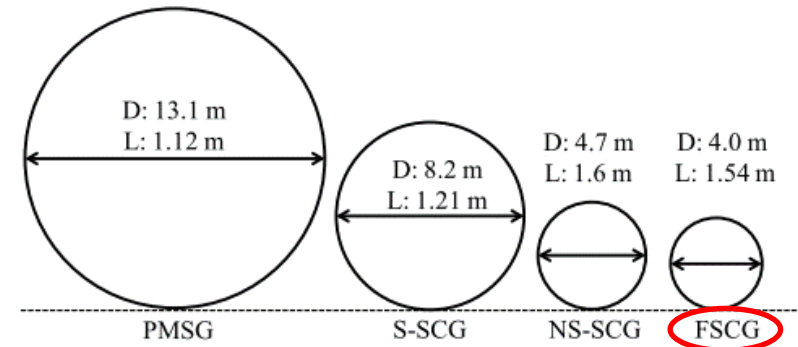

Fig. 7-1. Comparison of four wind turbine generator sizes [2]

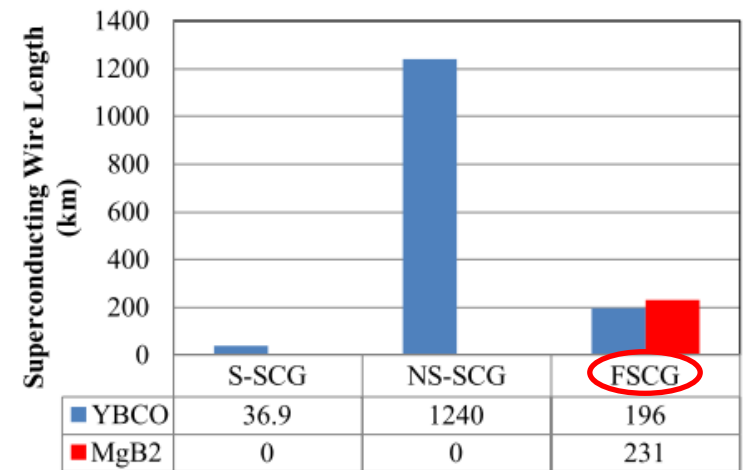
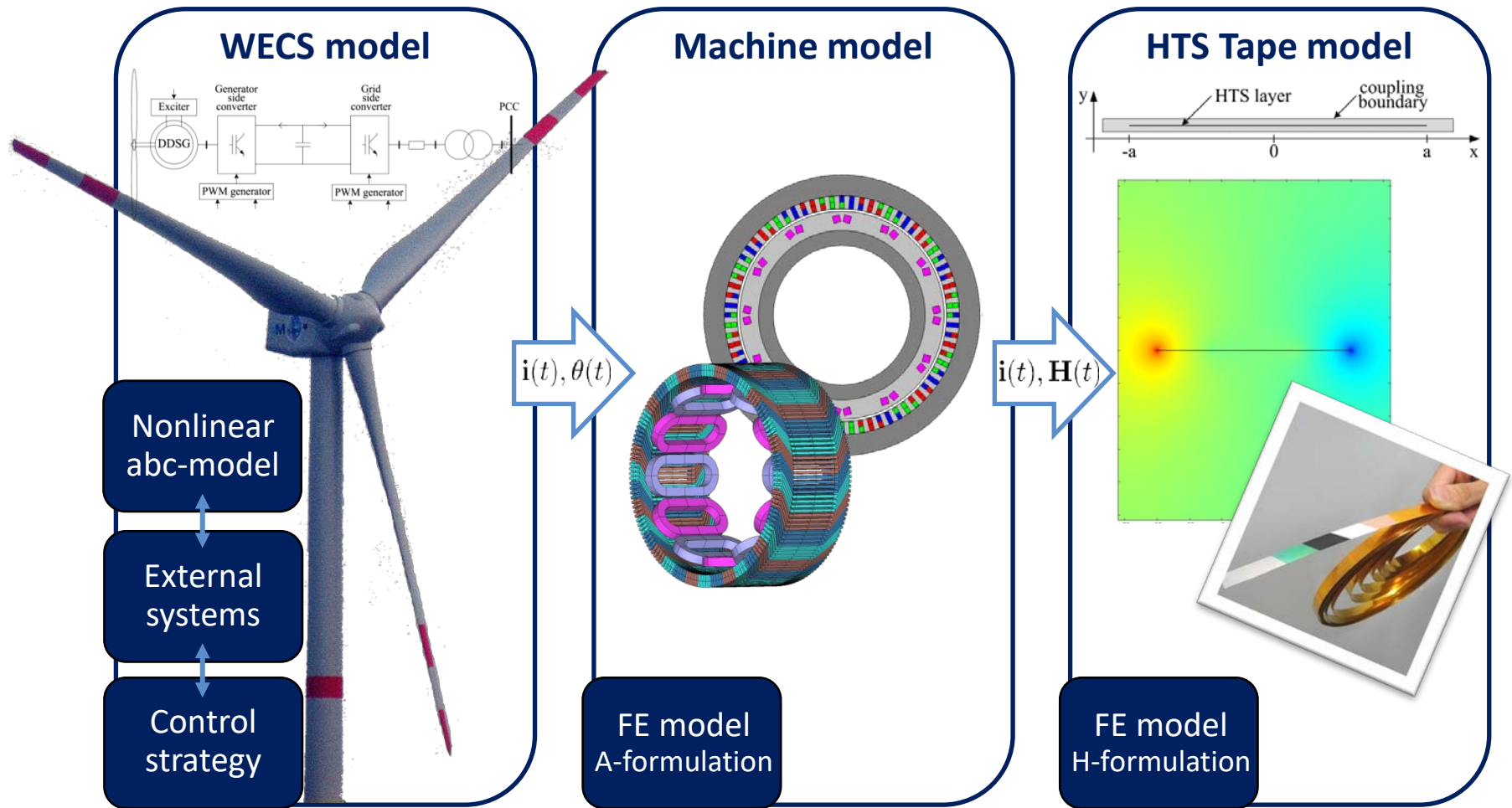

Fig. 7-2 Length of superconducting wires [2]

[1] Y. Terao, M. Sekino, H. Ohsaki, "Electromagnetic design of 10 MW class fully superconducting wind turbine generators," *IEEE Trans. on Applied Superconductivity*, vol. 22, no. 3, 2012.

[2] Y. Terao, "Electromagnetic design of light weight and high-power density superconducting synchronous machines for 10 MW class wind turbine generators," PhD thesis, The University of Tokyo, Tokyo, Japan, 2013.

# Simulation of grid-connected SC WT generators



[1] L. Quéval, H. Ohsaki, "AC losses of a grid-connected superconducting wind turbine generator," *IEEE Trans. on Applied Superconductivity*, vol. 23, no. 3, pp. 5201905, 2013.  
 [2] L. Quéval, M. Sekino, H. Ohsaki, "A coupled FE phase-domain model for superconducting synchronous machine," *IEEE Trans. on Applied Superconductivity*, vol. 22, no. 3, pp. 5200804, 2012.

# Numerical models for large superconducting coils

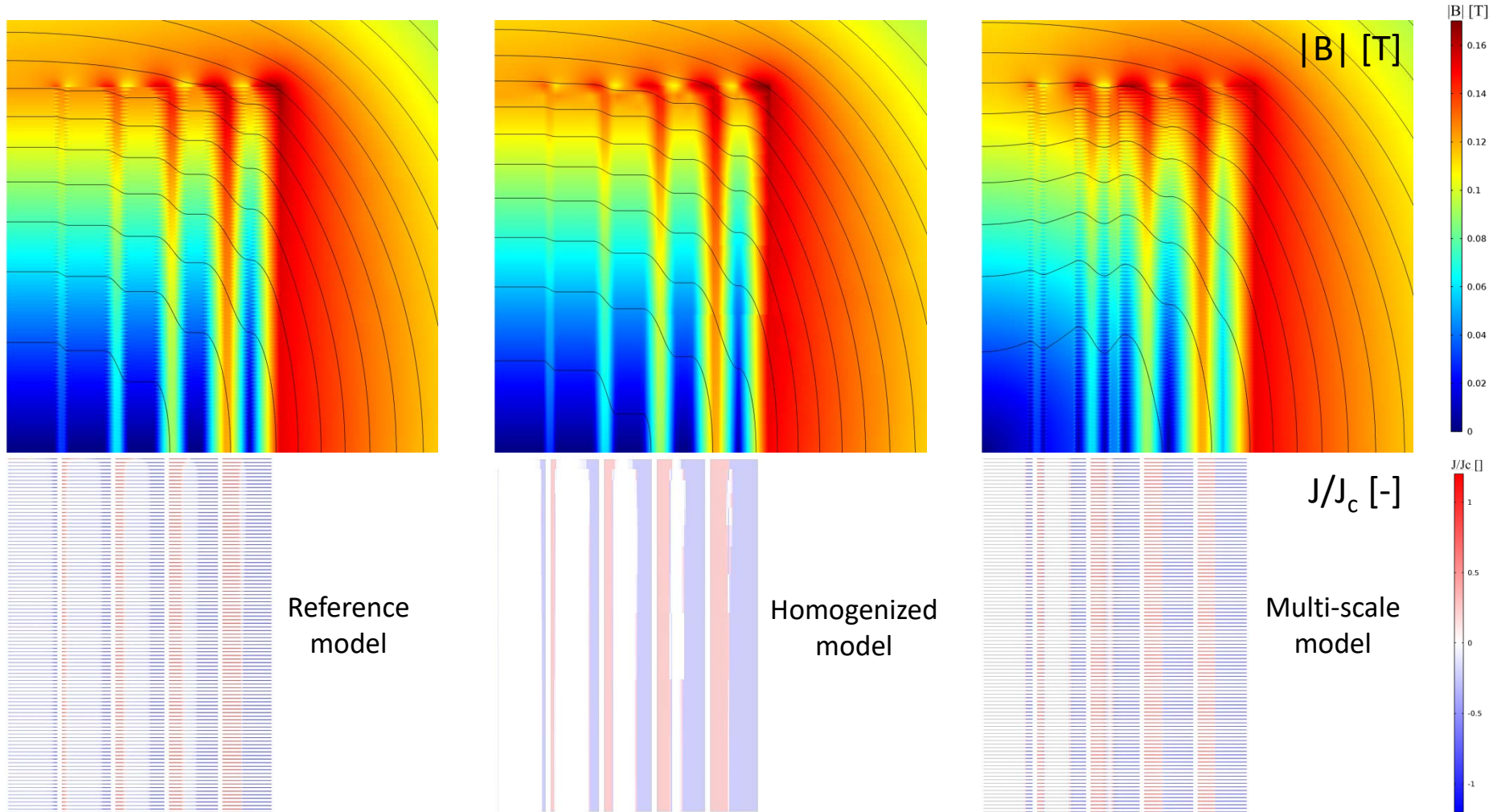

[1] L. Quéval, V.M.R. Zermeño, F. Grilli, "Numerical models for AC loss calculation in large-scale applications of HTS coated conductors," *Superconductor Science and Technology*, vol. 29, no. 2, Jan. 2016.

## Development in USA

DOE funded project to “Develop High-Efficiency, Lightweight Wind Turbine Generators for Tall Wind and Offshore Applications”

- [July 2019] DOE selected projects
- Each of the selected projects received \$500,000 to design a wind turbine generator that can be scaled up to at least 10 MW.
- 2 projects developed superconducting generators
  - AMSC develops HTS based concept – funding stopped
  - GE develops LTS based concept – 2<sup>nd</sup> phase started to develop a scaled demonstrator
- [Jan 2021] DOE selected GE to receive up to \$20.3 million to build and test a scaled prototype of their generator on a wind turbine.
- GE plan to produce a working prototype of a superconducting wind turbine generator by 2023.

# AMSC 10 MW DD SeaTitan



# GE 10 MW Ecomagination

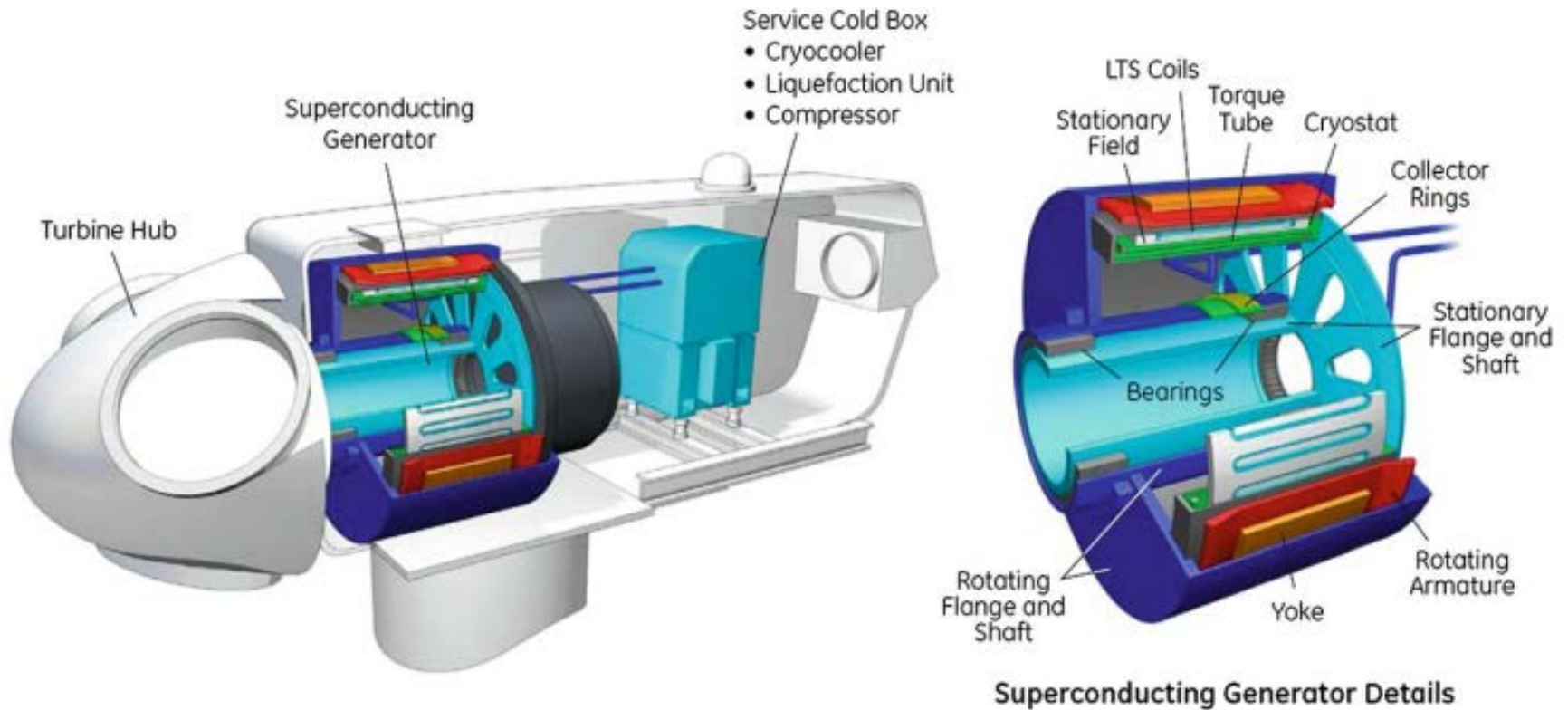

# AML 10 MW fully SC

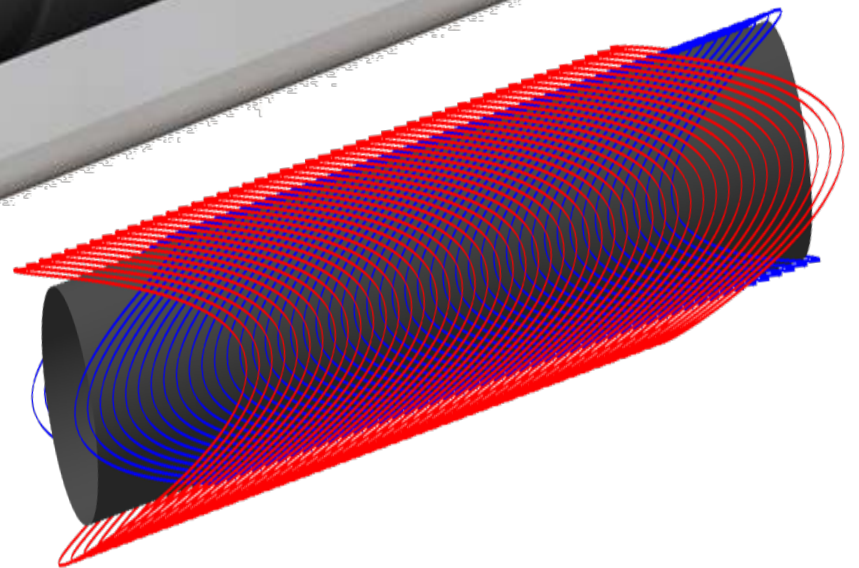
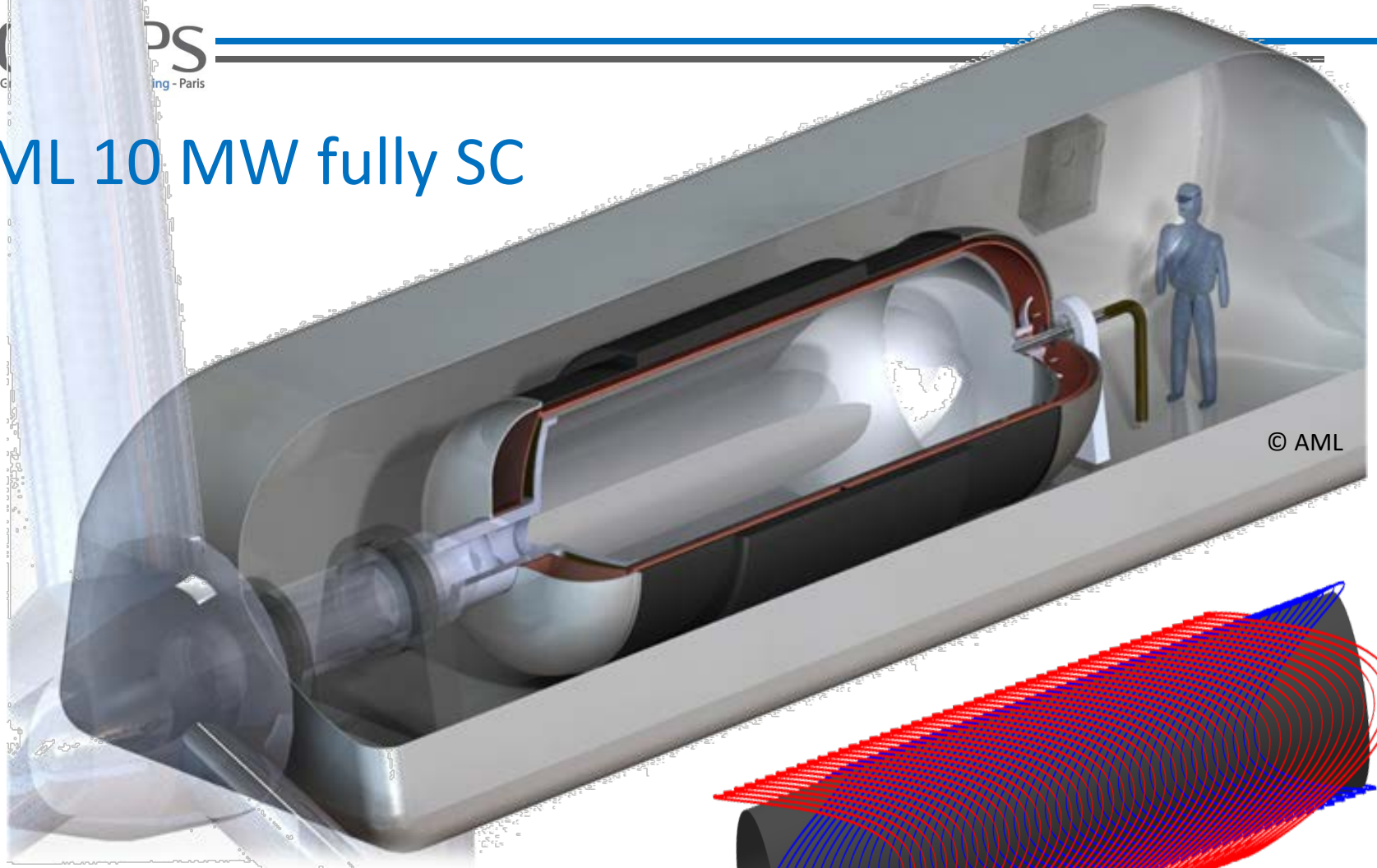

[1] L. Quéval, R. Gottkehaskamp, "Analytical field calculation of modulated double helical coils," *IEEE Transactions on Applied Superconductivity*, vol. 25, no. 6, pp. 4901307, Dec. 2015.

# Development in EU

- Innwind 10 ... 20 MW DD (Siemens)
  - Components demonstrated
  - LCOE: HTS vs. PM vs. magnetic gearbox
- SUPRApower (Tecnalia, ex. Acciona)
  - Design 10 MW DD, Hardware ?
- Windspeed (ECO 5)
  - Design 3.5 MW DD
- EcoSwing (Envision, Jeumont Elec.)
- EolSupra20 (Univ. Paris-Saclay)

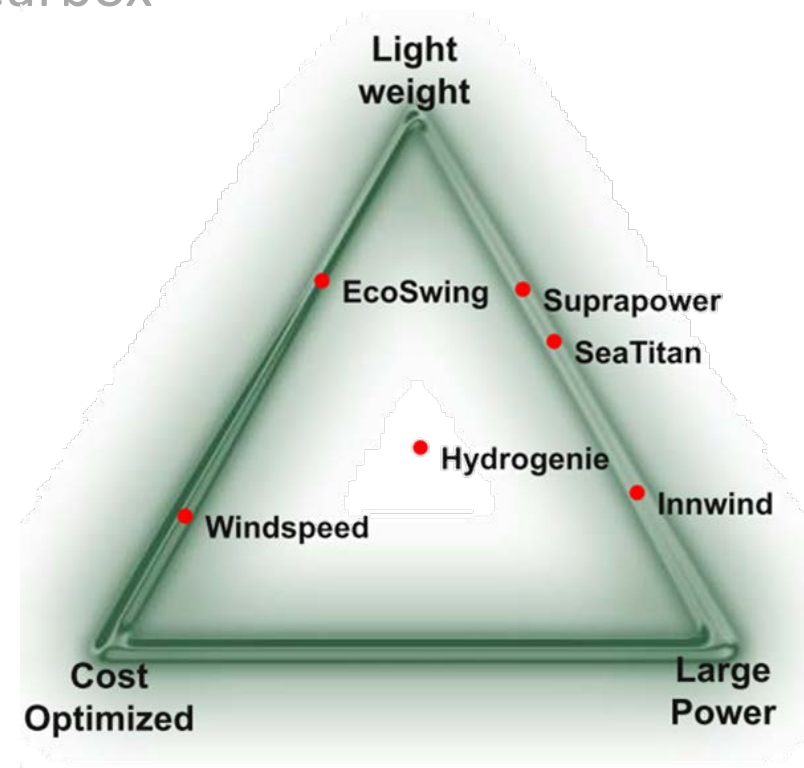

Adapted from [1] C. Bührer, "Attempting to shift a paradigm: HTS generators for cost-sensitive applications," DBU Seminar, Osnabrück, Apr, 2016.



# EcoSwing

## Our ambitions



- Design, develop and manufacture a full scale multi-megawatt superconducting wind generator
- Install this superconducting drive train on an existing modern wind turbine in Thyborøn, Denmark, replace existing PM generator (3 MW Class, 14 rpm, 128 m rotor)
- Prove that a superconducting drive train is lighter, smaller and cost-competitive.
- Start Date: 2015-03-01  
End Date: 2019-04-30



UNIVERSITY OF TWENTE.



Horizon 2020  
European Union Funding  
for Research & Innovation

# EcoSwing

## Elements of the EcoSwing superconductive generator

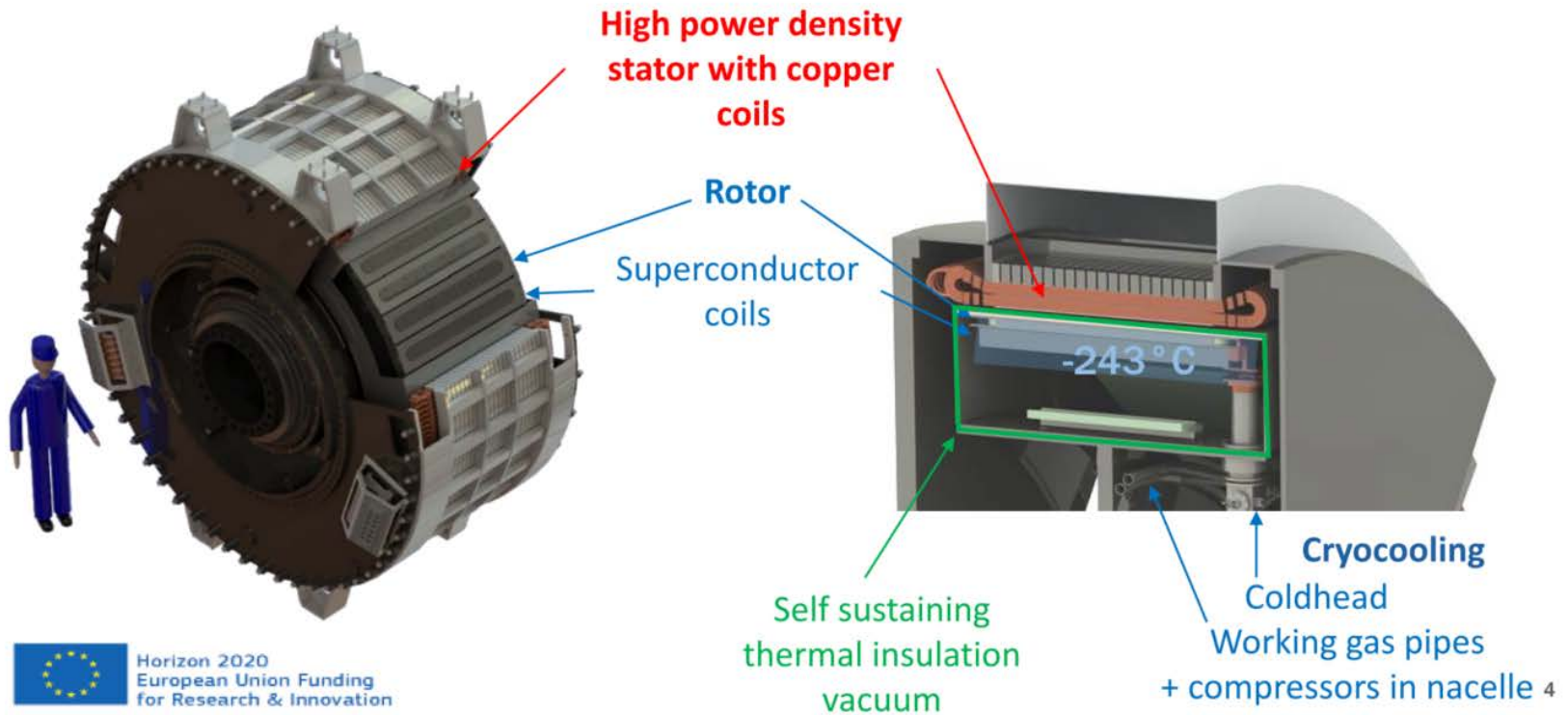

[1] M. Bauer, "Superconducting generators for wind power, EcoSwing generator and outlook," *COST ACTION 19108 Hi-Scale first joint WG3/4 industry-academia workshop on applications for HTS technologies in the electrical energy chain*, [online], Apr. 2021.

# EcoSwing

## EcoSwing design



- Decreased diameter from 5.4 m (PM generator) to 4 m
- Built **EcoSwing generator: 25 % weight reduction** compared to PM generator of same diameter
- Commercial design: **40% weight reduction** compared to PM generator.

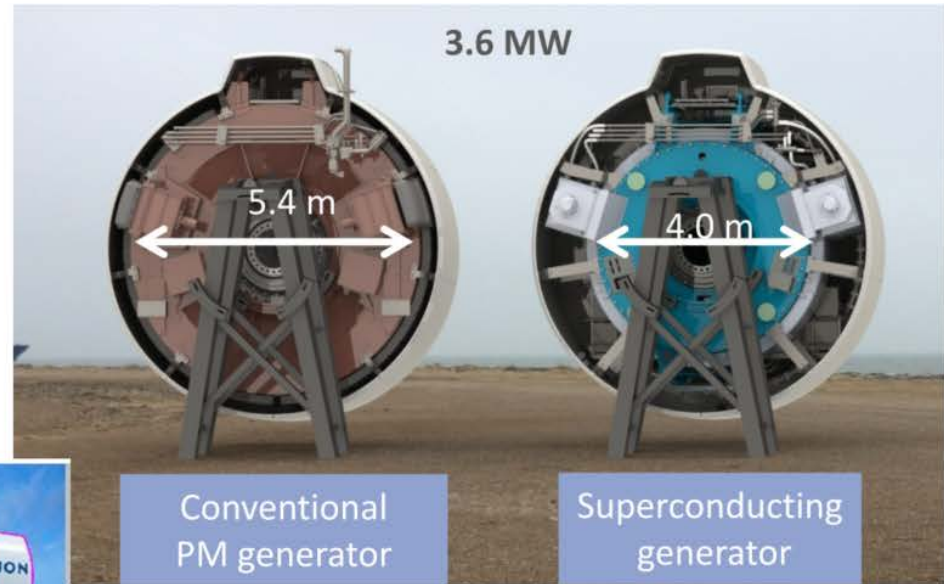

[1] M. Bauer, "Superconducting generators for wind power, EcoSwing generator and outlook," *COST ACTION 19108 Hi-Scale first joint WG3/4 industry-academia workshop on applications for HTS technologies in the electrical energy chain*, [online], Apr. 2021.

# EcoSwing

## Testing on ground and in turbine



At IWES,  
Bremerhaven  
for ground  
testing



Mounting on  
Envision wind  
turbine GC-1,  
Thyborøn,  
Denmark



[1] M. Bauer, "Superconducting generators for wind power, EcoSwing generator and outlook," *COST ACTION 19108 Hi-Scale first joint WG3/4 industry-academia workshop on applications for HTS technologies in the electrical energy chain*, [online], Apr. 2021.

# EcoSwing

## Main project results



- EcoSwing generator reached +3 MW
- Converter limit exceeded
- 50 months EU project concluded on time
- +7 months stable reliable cryogenics
- +650 h producing power
- Superconducting coils showed great performance
- 25.4.2019 EcoSwing switched-off

Whats next?

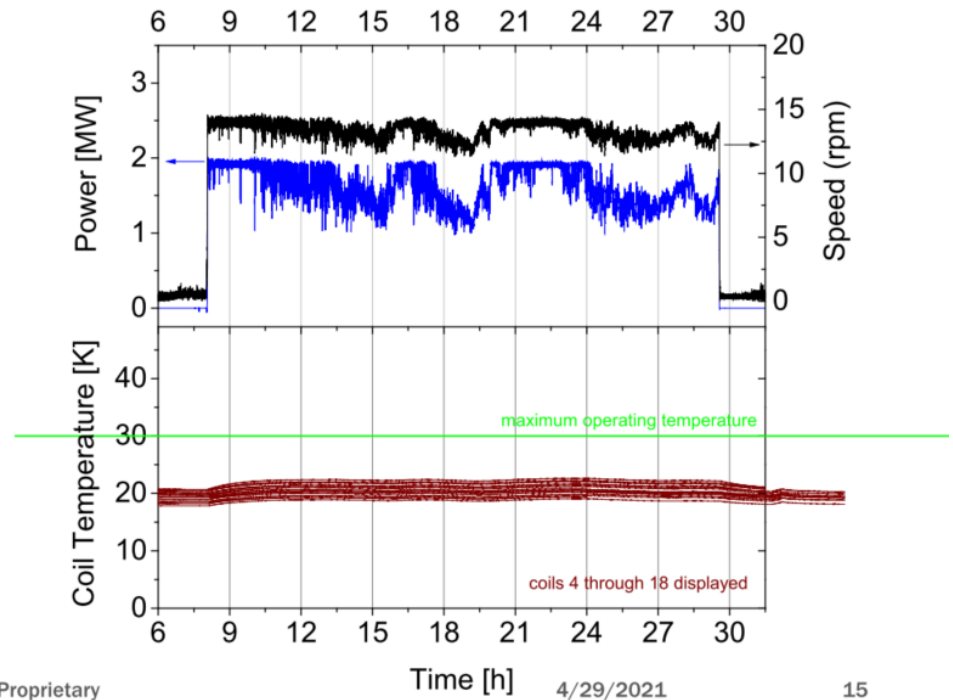

Confidential and Proprietary

15

[1] M. Bauer, "Superconducting generators for wind power, EcoSwing generator and outlook," *COST ACTION 19108 Hi-Scale first joint WG3/4 industry-academia workshop on applications for HTS technologies in the electrical energy chain*, [online], Apr. 2021.

# EolSupra20

Feasibility study of a 20 MW superconducting wind turbine generator

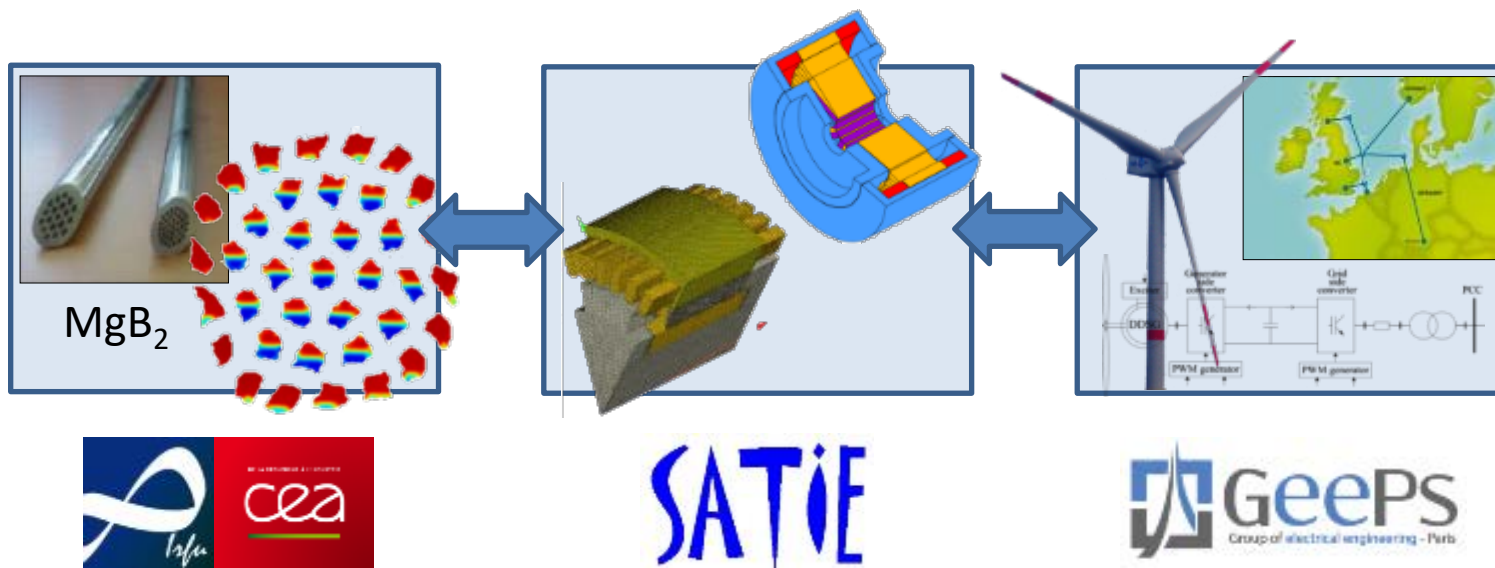

# EolSupra20

Design and optimization of the electromagnetic/cryogenic designs of a 20 MW fully SC wind turbine generator to minimize the LCOE

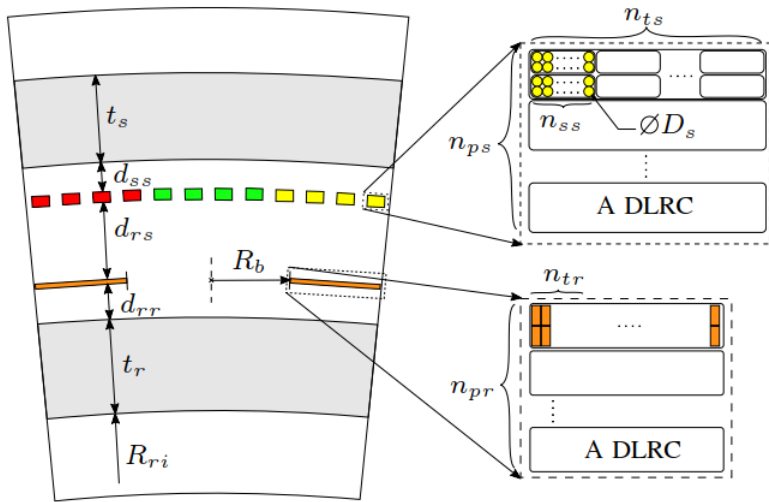

Fig. 1 - EolSupra20 electromagnetic design

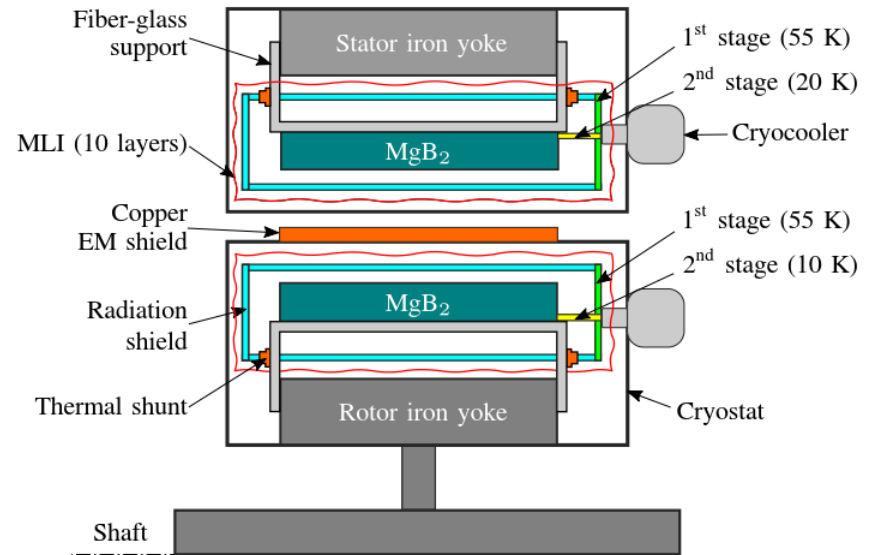

Fig. 2 - EolSupra20 cryogenic design

[1] T.-K. Hoang, L. Quéval, L. Vido, C. Berriaud, "Impact of the rotor blade technology on the levelized cost of energy of an offshore wind turbine," *Joint International Conference OPTIM-ACEMP*, Brasov, Romania, May 2017.

[2] T.-K. Hoang, L. Quéval, C. Berriaud, L. Vido, "Design of a 20 MW fully superconducting wind turbine generator to minimize the levelized cost of energy," *IEEE Transactions on Applied Superconductivity*, vol. 28, no. 4, pp. 1-4, June 2018.

# EolSupra20

## EolSupra20 2018 base design

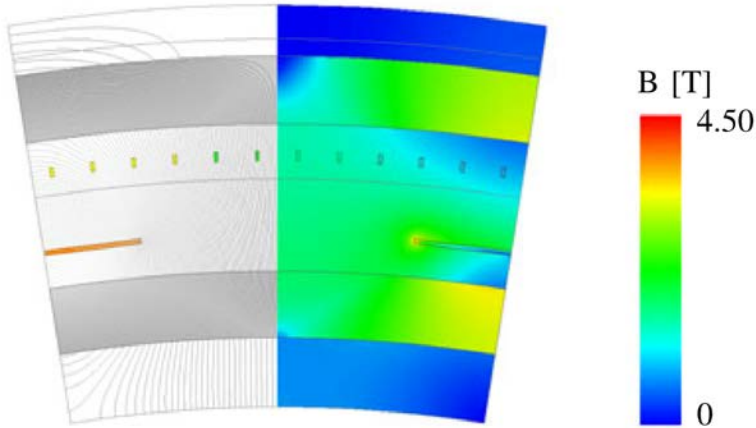

Rotor:

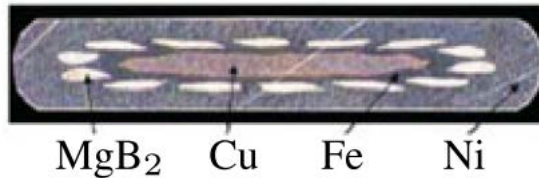

Stator:

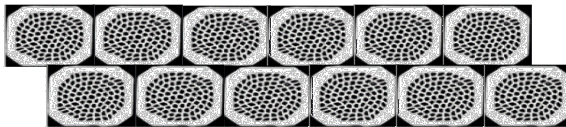

Description	Value
<b>Rotor winding</b>	
MgB <sub>2</sub> conductor length [km]	37
Current density in filaments [A/mm <sup>2</sup> ]	2276/3294
Max. magnetic flux density [T]	4.01
First stage (55 K) losses [W]	268
Second stage (10 K) losses [W]	37
Nb of cryocoolers [-]	8
<b>Stator winding</b>	
MgB <sub>2</sub> conductor length [km]	104
Current density in filaments [A/mm <sup>2</sup> ]	3165/4212
Max. magnetic flux density [T]	1.72
First stage (55 K) losses [W]	929
Second stage (20 K) losses [W]	1291
Nb of cryocoolers [-]	77
<b>Machine geometry</b>	
Phase-phase voltage [kV rms]	3.2
Output power [MW]	20
Outer stator yoke radius [m]	3.01
Active and inactive mass [kg]	167512
<b>Economics</b>	
Generator cost [\$M]	5.81

[1] T.-K. Hoang, L. Quéval, C. Berriaud, L. Vido, "Design of a 20 MW fully superconducting wind turbine generator to minimize the levelized cost of energy," *IEEE Transactions on Applied Superconductivity*, vol. 28, no. 4, pp. 1-4, June 2018.



# EolSupra20

## EolSupra20 2018 base design



Air Liquide Turbo-Brayton TBF-80

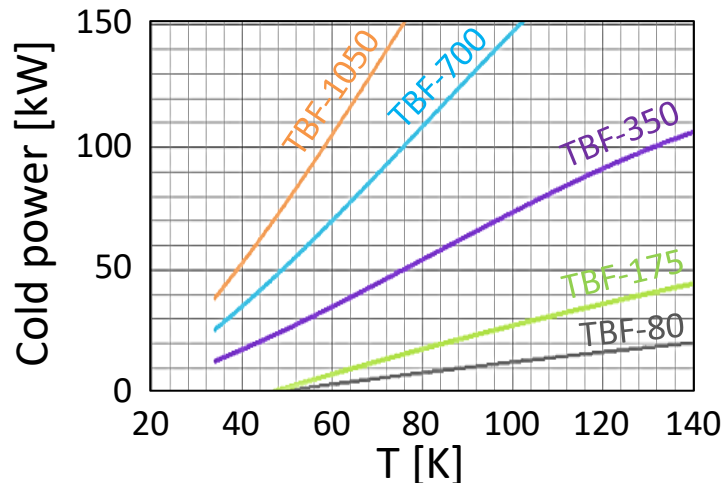

Description	Value
<b>Rotor winding</b>	
MgB2 conductor length [km]	37
Current density in filaments [A/mm <sup>2</sup> ]	2276/3294
Max. magnetic flux density [T]	4.01
First stage (55 K) losses [W]	268
Second stage (10 K) losses [W]	37
Nb of cryocoolers [-]	8
<b>Stator winding</b>	
MgB2 conductor length [km]	104
Current density in filaments [A/mm <sup>2</sup> ]	3165/4212
Max. magnetic flux density [T]	1.72
First stage (55 K) losses [W]	929
Second stage (20 K) losses [W]	1291
Nb of cryocoolers [-]	77
<b>Machine geometry</b>	
Phase-phase voltage [kV rms]	3.2
Output power [MW]	20
Outer stator yoke radius [m]	3.01
Active and inactive mass [kg]	167512
<b>Economics</b>	
Generator cost [\$M]	5.81

[1] C. Gondrand, "Turbo-Brayton cryogenic systems, An ideal solution for refrigeration," *EASISchool2*, Oct. 2019.

# EolSupra20

Some trends (offshore floating) ...

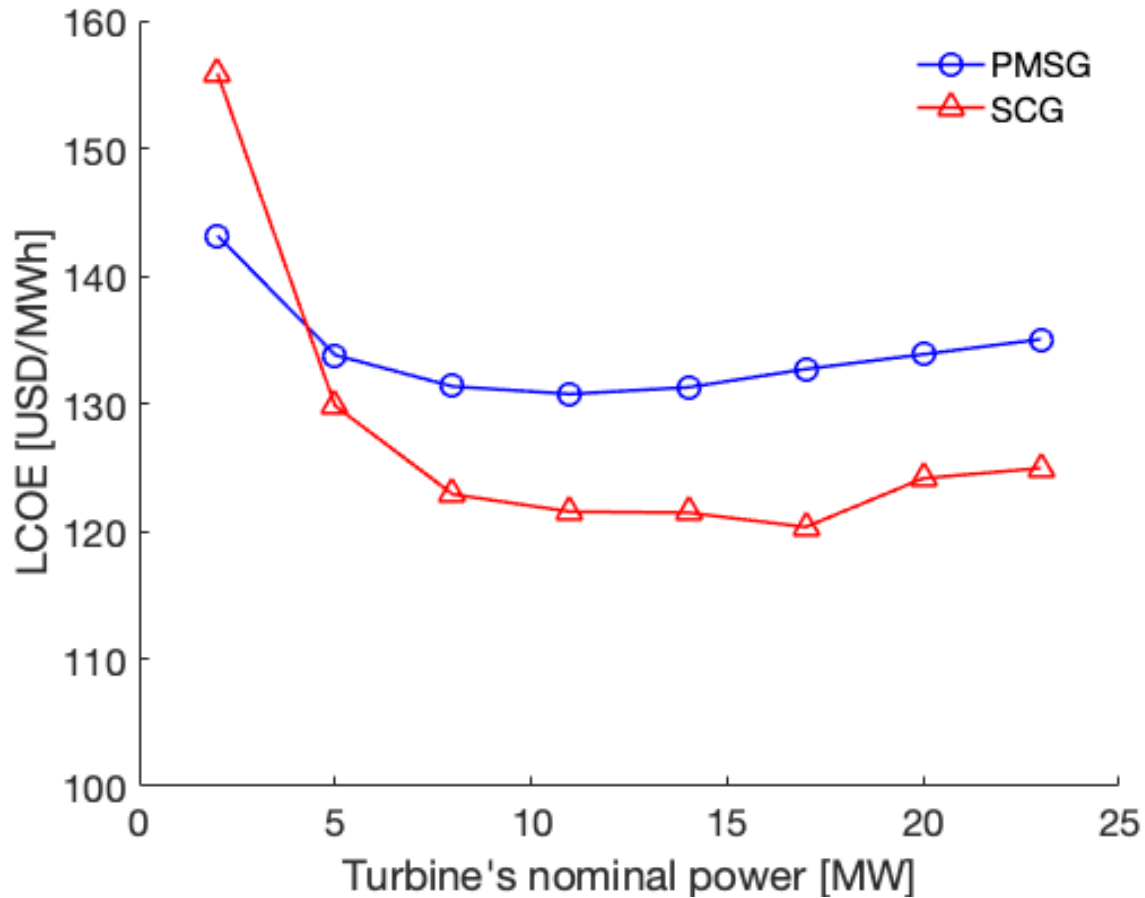

[1] T.-K. Hoang, L. Quéval, L. Vido, D.-Q. Nguyen, "Levelized cost of energy comparison between permanent magnet and superconducting wind generators for various nominal power," *IEEE Transactions on Applied Superconductivity*, vol. 32, no. 7, id. 5202606, Oct. 2022.

# Development in South Korea

## I. Overview of the E-cluster

에너지신기술 Cluster

기초연구 러닝. 기초전력연구센터가 앞장서겠습니다.

**Final target: Development of basic technology for floating offshore wind power platform based on 10MW HTS wind power generator**

10 MW generator

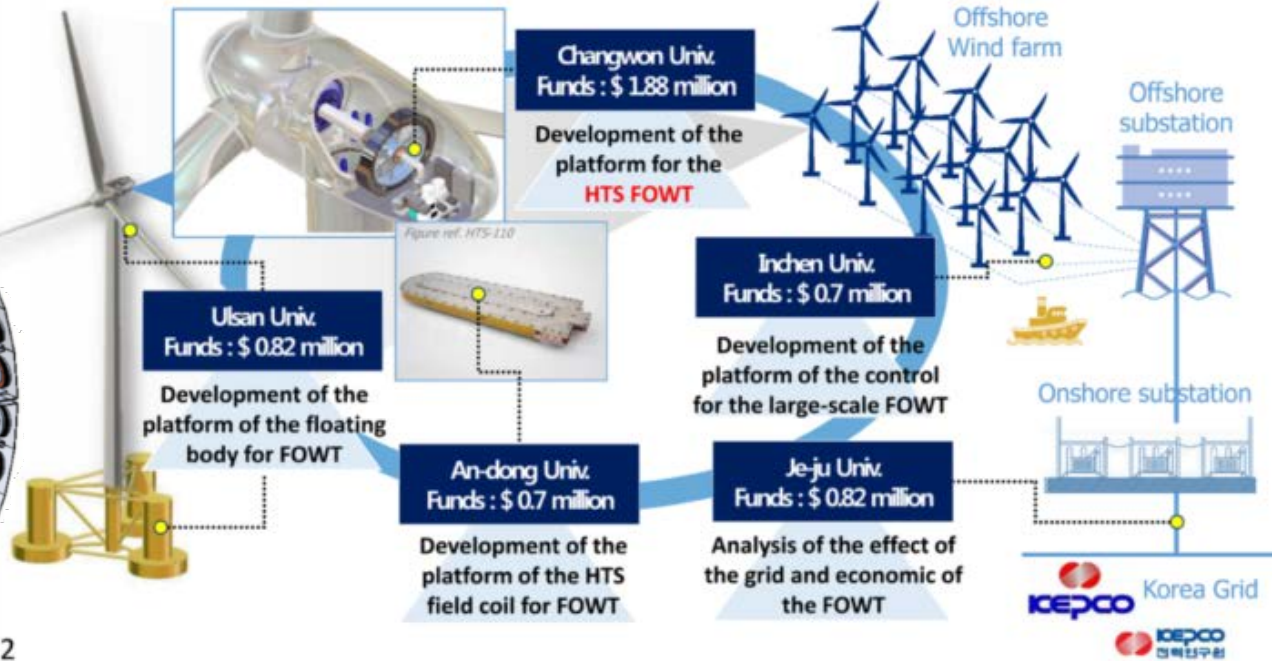
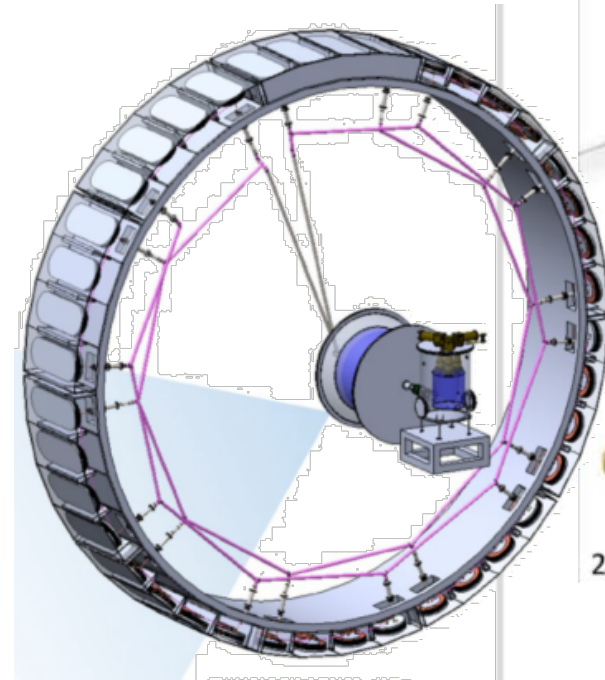

2

Adapted from [1] M. Bauer, "Superconducting generators for wind power, EcoSwing generator and outlook," *COST ACTION 19108 Hi-Scale first joint WG3/4 industry-academia workshop on applications for HTS technologies in the electrical energy chain*, [online], Apr. 2021.

# V. Conclusion

## Conclusion

- Superconducting wind turbines are still in the laboratory development phase.
- EcoSwing: world's first HTS wind turbine in 2019.
- Currently no pilot projects nor industrial deployment. TRL 4-5.
- Today 16 MW conventional machines. Tomorrow 20 MW ? The business case needs to be re-examined ...
  - Technical motivation: 30 MW ?
  - Techno-economic assessment: LCOE of the full system ?
  - Critical raw material act: rare earth materials.
- Fully HTS machines have potential for >20 MW floating offshore wind turbines. Bottlenecks identified in 2018 on the way to being resolved: Conductor length & Cooling system.

---



# Geeps

Electrical Engineering - Paris

**Merci !**





# Technology Readiness Levels

- TRL 0: Idea.** Unproven concept, no testing has been performed.
- TRL 1: Basic research.** Principles postulated and observed but no experimental proof available.
- TRL 2: Technology formulation.** Concept and application have been formulated.
- TRL 3: Applied research.** First laboratory tests completed; proof of concept.
- TRL 4: Small scale prototype** built in a laboratory environment ("ugly" prototype).
- TRL 5: Large scale prototype** tested in intended environment.
- TRL 6: Prototype system** tested in intended environment close to expected performance.
- TRL 7: Demonstration system** operating in operational environment at pre-commercial scale.
- TRL 8: First of a kind commercial system.** Manufacturing issues solved.
- TRL 9: Full commercial application,** technology available for consumers.