



**HAL**  
open science

## Successful treatment of JAK1 associated inflammatory disease

Antoine Fayand, Véronique Hentgen, Céline Posseme, Carole Lacout, Capucine Picard, Philippe Moguelet, Margaux Cescato, Nabiha Sbeih, Thomas R.J. Moreau, Yixiang Yj. Zhu, et al.

### ► To cite this version:

Antoine Fayand, Véronique Hentgen, Céline Posseme, Carole Lacout, Capucine Picard, et al.. Successful treatment of JAK1 associated inflammatory disease. *Journal of Allergy and Clinical Immunology*, 2023, 152 (4), pp.972-983. 10.1016/j.jaci.2023.06.004 . hal-04137977

**HAL Id: hal-04137977**

**<https://hal.science/hal-04137977>**

Submitted on 22 Jun 2023

**HAL** is a multi-disciplinary open access archive for the deposit and dissemination of scientific research documents, whether they are published or not. The documents may come from teaching and research institutions in France or abroad, or from public or private research centers.

L'archive ouverte pluridisciplinaire **HAL**, est destinée au dépôt et à la diffusion de documents scientifiques de niveau recherche, publiés ou non, émanant des établissements d'enseignement et de recherche français ou étrangers, des laboratoires publics ou privés.



Distributed under a Creative Commons Attribution - NonCommercial 4.0 International License

## 1 Successful treatment of *JAK1* associated inflammatory disease

2 Antoine Fayand<sup>1,21</sup> MD, Véronique Hentgen<sup>2\*</sup> MD, Céline Posseme Ph.D<sup>3\*</sup>, Carole Lacout<sup>4,21\*</sup>  
3 MD, Capucine Picard<sup>5</sup> MD, Ph.D, Philippe Moguelet<sup>6</sup> MD, Margaux Cescato<sup>1</sup> M.Sc, Nabiha  
4 Sbeih<sup>7</sup> MD, Thomas R.J. Moreau<sup>1</sup> M.Sc, Yixiang YJ Zhu<sup>1</sup> M.Sc, Jean-Luc Charuel<sup>8</sup> MD,  
5 Aurélien Corneau<sup>9</sup> Ph.D, Joelle Deibener-Kaminsky<sup>10</sup> MD, Stéphanie Dupuy<sup>11</sup> Ph.D, Mathieu  
6 Fusaro<sup>5</sup> MD, Benedicte Hoareau<sup>9</sup> M.Sc, Alain Hovnanian<sup>12,13</sup> MD, Ph.D, Vincent Langlois<sup>14</sup>,  
7 Laurent Le Corre<sup>15</sup>, Thiago T Maciel<sup>7</sup> Ph.D, Snaigune Miskinyte<sup>12</sup> M.Sc, Makoto Miyara<sup>8,16</sup>  
8 MD, Ph.D, Thomas Moulinet<sup>10</sup> MD, Magali Perret<sup>17</sup> MD, Marie Hélène Schuhmacher<sup>18</sup> MD,  
9 Rachel Rignault-Bricard<sup>7</sup>, Ph.D, Sébastien Viel<sup>13</sup> MD, Ph.D, Angélique Vinit<sup>9</sup> M.Sc, Angèle  
10 Soria<sup>19</sup> MD, Ph.D, Darragh Duffy<sup>3</sup> Ph.D, Jean-Marie Launay<sup>20</sup> MD, Ph.D, Jacques Callebert<sup>20</sup>  
11 MD, Ph.D, Jean Philippe Herbeuval<sup>1</sup> Ph.D, Mathieu P Rodero<sup>18</sup> Ph.D, Sophie Georgin-  
12 Lavialle<sup>21§†</sup> MD, Ph.D.

13  
14 <sup>1</sup> Université Paris Cité, CNRS, Laboratoire de Chimie et de Biochimie Pharmacologiques et  
15 Toxicologiques, F-75006 Paris, France

16 <sup>2</sup> Pediatric Infectious Disease Group (GPIP), Créteil, France;

17 Department General Pediatrics, Centre Hospitalier de Versailles, Le Chesnay, France.

18 <sup>3</sup> Translational Immunology Unit, Institut Pasteur, Université de Paris Cité, Paris, France

19 <sup>4</sup> Sorbonne University, Genetic Laboratory, Assistance Publique - Hôpitaux de Paris (APHP),  
20 Trousseau Hospital, Paris, France.

21 <sup>5</sup> Study Center for Primary Immunodeficiencies, APHP, Necker Hospital for Sick Children,  
22 Université de Paris Cité, Paris, France.

23 <sup>6</sup> Department of Pathology, Sorbonne University, Tenon Hospital, APHP, Paris, France.

24 <sup>7</sup> Laboratory of Cellular and Molecular Mechanisms of Hematological Disorders and  
25 Therapeutical Implications, Université Paris Cité, Imagine Institute, Inserm U1163, Paris,  
26 France

27 <sup>8</sup> Groupement Hospitalier Pitié-Salpêtrière APHP, Département of immunology, Paris, France.

28 <sup>9</sup> Sorbonne Université, UMS037, PASS, Plateforme de Cytométrie de la Pitié-Salpêtrière CyPS,  
29 Paris, France.

30 <sup>10</sup> Department of Internal Medicine and Clinical Immunology, Nancy University Hospital, 5  
31 Rue du Morvan, Vandoeuvre-lès-Nancy 54500, France; UMR 7365, IMoPA, University of  
32 Lorraine, CNRS, Nancy, France.

33 <sup>11</sup> BioMedTech Facilities INSERM US36 - CNRS UAR2009 - Université Paris Cité, France.

34 <sup>12</sup> INSERM UMR1163, Laboratory of genetic skin diseases, Imagine Institute, University Paris  
35 Cité, Paris, France.

36 <sup>13</sup> Department of Genomics Medicine of Rare Diseases, Hôpital Necker Enfants Malades, AP-  
37 HP, Paris, France.

38 <sup>14</sup> Department of Internal Medicine, Jacques Monod Hospital, Le Havre, France.

39 <sup>15</sup> Université de Paris Cité, CNRS, UMR8601, LCBPT, Macromolecular Modeling Platform,  
40 Paris, France.

41 <sup>16</sup> Inserm U1135, Centre d'Immunologie et des Maladies Infectieuses (CIMI-Paris), Hôpital  
42 Pitié-Salpêtrière, AP-HP, Sorbonne Université, Paris, France

43 <sup>17</sup> Immunology Laboratory, Lyon Sud Hospital, Hospices Civils de Lyon, University of Claude  
44 Bernard-Lyon 1, Lyon, France.

45 <sup>18</sup> Department of Internal Medicine, Emile Durkheim Hospital, Épinal, France.

46 <sup>19</sup> Tenon Hospital, Dermatology-Allergology Department, Sorbonne University, Paris, France.

47 <sup>20</sup> Service of Biochemistry and Molecular Biology, INSERM U942, Hospital Lariboisière,  
48 APHP, Paris, France.

49 <sup>21</sup> Sorbonne Université, APHP, Tenon Hospital, department of internal medicine, Paris, France.

50

51 \* Contributed equally

52 § Codirected the study

53

54 † Corresponding author: Sophie Georgin-Lavialle: Sorbonne Université, APHP, Tenon  
55 hospital, Department of Internal Medicine, National reference center for autoinflammatory  
56 diseases and inflammatory amyloidosis (CEREMAIA), Paris, France.

57 [sophie.georgin-lavialle@aphp.fr](mailto:sophie.georgin-lavialle@aphp.fr)

58

59 Dr Hentgen and Dr Georgin-Lavialle declare no conflict of interest in relation to this  
60 manuscript. They have consultancy or speaking activities for SOBI and Novartis not related to  
61 this work. The rest of the authors declare that they have no relevant conflicts of interest.

62

63 **Background:** Gain of function (GOF) variants of *JAK1* drive a rare immune dysregulation  
64 syndrome associated with atopic dermatitis, allergy and eosinophilia.

65 **Objectives:** To describe the clinical and immunological characteristics associated with a new  
66 GOF variant of *JAK1* and report the therapeutic efficacy of JAK inhibition.

67 **Methods:** We identified a family affected by *JAK1* associated autoinflammatory disease and  
68 performed clinical assessment and immunological monitoring on 9 patients. *JAK1* signalling  
69 was studied by flow and mass cytometry in patients' cells at basal state, or after immune  
70 stimulation. A molecular disease signature in the blood was studied at the transcriptomic  
71 level. Patients were treated with one of two JAK inhibitors; either baricitinib or upadacitinib.  
72 Clinical, cellular, and molecular response were evaluated over a 2-year period.

73 **Results:** Affected individuals displayed a syndromic disease with prominent allergy including  
74 atopic dermatitis, ichthyosis, arthralgia, chronic diarrhoea, disseminated calcifying fibrous  
75 tumours and elevated whole blood histamine levels. A variant of *JAK1* localized in the  
76 pseudokinase domain was identified in all 9 affected tested patients. Hyper-phosphorylation  
77 of STAT3 was found in 5 out of 6 patients tested. Treatment of patients' cells with baricitinib  
78 controlled most of the atypical hyper-phosphorylation of STAT3. Administration of baricitinib  
79 to patients led to rapid improvement of the disease in all adults and was associated with  
80 reduction of systemic inflammation.

81 **Conclusions:** Patients with this new *JAK1* GOF pathogenic variant displayed very high levels of  
82 blood histamine and showed a variable combination of atopy with articular and  
83 gastrointestinal manifestations as well as calcifying fibrous tumours. The disease, that appears  
84 to be linked to STAT3 hyper-activation, was well controlled under treatment by JAK inhibitors  
85 in adult patients.

86

87 **Clinical implication** – This study significantly expands the clinical spectrum of *JAK1* associated  
88 autoinflammatory disease and report the clinical benefit of two distinct JAK inhibitors over a  
89 2-year period in a large family.

90 **Capsule summary**– This study opens new avenues in the diagnosis and treatment of JAK1  
91 associated autoinflammatory disease. It should help to reduce diagnostic delay of *JAK1*  
92 mutated patients.

93

94 **Keywords: JAK 1, atopic dermatitis, JAK inhibitors, inborn errors of immunity, allergy**

95

## 96 **Abbreviations**

97 CyTOF: cytometry by time of flight = mass cytometry  
98 CT-scan: computer tomography scan  
99 ENT: ear-nose-throat  
100 FACS: fluorescence activated cell sorting  
101 GOF: gain of function  
102 IBD: inflammatory bowel disease  
103 IFN: interferon  
104 IL: interleukin  
105 JAK: Janus kinase  
106 JAID: JAK1 associated inflammatory disease  
107 NGS: next generation sequencing  
108 PBMCs: peripheral blood mononuclear cells  
109 STAT: signal transducer and activator of transcription  
110

111 **Introduction:**

112 Cytokines are soluble effector proteins produced by a variety of cells of hematopoietic  
113 or stromal origin that act as key regulators of both the innate and the adaptive immune  
114 response. As such, a significant number of pathogenic variants of cytokines, receptors to  
115 cytokines or proteins involved in downstream signalling, such as proteins of the Janus kinase  
116 (JAK)- Signal transducer and activator of transcription (STAT) (JAK-STAT) pathway, have been  
117 associated with rare inborn errors of immunity (1). Inborn errors of immunity are  
118 heterogeneous rare diseases secondary to monogenic germline pathogenic variants resulting  
119 in autoimmunity, autoinflammation, allergy, and increased susceptibility to infectious  
120 diseases and/or malignancy (2–4).

121 Beyond simply increasing our understanding of the immune system, identifying such  
122 disorders has an obvious interest in selecting the most appropriate management strategy for  
123 patients that often have a long personal history of multiple treatment failures (5,6). Indeed,  
124 cytokines, their receptors and members of the JAK/STAT pathway are the targets of an  
125 increasing number of innovative treatments developed in recent years that are now used in  
126 daily clinical practice (7–9). These drugs, originally developed to treat more common  
127 immunological or haematological diseases, are therefore broadly available for prompt and  
128 targeted treatment of these rare patients, achieving an efficient translational medicine  
129 approach.

130 Here, we investigated 9 patients of a large French family affected by a dominantly  
131 inherited early-onset immune dysregulation syndrome with prominent allergy and  
132 autoinflammation related to a previously unreported heterozygous p.Cys787Phe gain of  
133 function (GOF) variant of *JAK1* gene. JAK1 is involved in the signalling of multiple cytokine  
134 receptors including those of the interferon (IFN), gp130,  $\gamma_c$  type, IL-3/ $\beta_c$  and single chain  
135 families (10). JAK1 associated inflammatory disease (JAID)(11) is an extremely rare and poorly  
136 understood condition previously reported in only 5 individuals from 3 kindreds (12–14). We  
137 describe the unique clinical and immunological characteristics associated with the same  
138 Cys787Phe pathogenic variant and report the therapeutic efficacy of two JAK inhibitors with  
139 a follow-up of 2 years.

140

141

142 **Methods**

143 Patients and study approval

144 All patients, or parents for children, and healthy relatives provided written informed consent  
145 for participation, genetic testing, and blood samples. As part of their routine care, patients  
146 underwent a series of complete physical examinations and several biological, radiological and  
147 pathological studies.

148

149 Genetic investigation

150 We performed a Next Generation Sequencing (NGS) panel targeting 300 genes causal of PID  
151 (15). This strategy led to the identification of a heterozygous missense variant in the exon 19  
152 of *JAK1* gene. This *JAK1* variant was confirmed by Sanger sequencing for the index case and  
153 several members of his kindred.

154

155 Functional Studies

156 We obtained blood and tissue samples from the study participants to assess the inflammatory  
157 profile. Circulating cytokine and allergic related mediator dosages were performed on plasma  
158 according to standard procedures. PBMCs or whole blood cells were incubated at 37°C with  
159 IFN- $\alpha$ 2, IL-2, IL-4 or IL-6 for 30 min. Cellular response was then assessed using fluorescence  
160 activated cell sorting (FACS) or mass cytometry (CyTOF). For treated conditions, cells were  
161 incubated at 37°C with baricitinib (200 nM) for 15 min prior to cytokine stimulation.

162 To study the transcriptomic signature of the disease, and the response to baricitinib  
163 treatments a total of 100 ng RNA per sample was used to assess the expression of 750 genes  
164 involved in immunity with the nCounter Human Autoimmune Profiling Panel (Nanostring).

165 Additional details are provided in the Supplementary Appendix.

166

167

168 **Results**

169

170 **Disease manifestations**

171 From birth, the index patient (V-1) had presented severe dermatitis and multiple food  
172 allergies, leading to the identification of a complex immune dysregulation syndrome of  
173 apparently dominant inheritance within his family. All affected individuals displayed diffuse  
174 ichthyosiform skin lesions and atopic dermatitis-like presentation (Table 1 and S1, Fig. 1 and  
175 S1). The ichthyosiform skin lesions were characterized by scaling and hyperkeratosis, with  
176 occasional cracks in the palms and erythematous areas. None of the individuals had bullous  
177 or erythrodermal lesions as part of the ichthyosis. The skin was also lichenified with areas of  
178 intense xerosis and infiltrated erythematous lesions especially on the face in most patients.  
179 CT scan in all affected adults identified disseminated nodules of soft tissue density with  
180 occasional calcification involving both thoracic and abdominal cavities as well as testis (Fig.  
181 1E). Though most patients did not report symptoms related to the nodules, patient IV-5  
182 underwent orchidectomy due to concerns about possible testicular cancer and developed  
183 dysphagia due to a large lower esophageal lesion. Pathological examination of these tumors  
184 revealed hypocellular hyalinized collagen with uniform proliferation of fibroblastic spindle  
185 cells, inflammatory infiltrate, and large ranges of calcifications, consistent with benign  
186 calcifying fibrous tumors (Fig. S2). Besides these common features, patients displayed various  
187 other manifestations: oligoarthritis, asthma, susceptibility to warts and ENT infections and  
188 chronic diarrhea. Fecal calprotectin, digestive endoscopies with systematic gastrointestinal  
189 biopsies were normal except in patient IV-7 in whom exulcerated nodular lesions of the lower  
190 esophagus and aphthoid lesions of the jejunum and ileum were found. Biopsies of the ileal  
191 lesions showed aspecific inflammation. The diagnosis of unclassified IBD was made in this  
192 patient, while the others were diagnosed with motility-related diarrhea. Of note, most  
193 patients also had food allergies that started in childhood and improved spontaneously over  
194 time. Failure to thrive was noted in two children with severe food allergies and two adults had  
195 a short stature. Additionally, two patients displayed unique features: III-6 had a voluminous  
196 nodular splenomegaly related to sclerosing angiomatoid nodular transformation (Fig. S2) and  
197 IV-5 had Addison's disease.



198 All patients displayed biological features of allergy: all had extremely high whole blood  
199 histamine levels, and most of them displayed mild basophilia, high total IgE levels, and mild  
200 eosinophil elevation between 500 and 2000/mm<sup>3</sup>. Mild hypogammaglobulinemia was noted  
201 in 4 patients. Blood lymphocyte phenotyping revealed inconstant CD3 and CD19  
202 lymphocytosis (Fig. S3). Broad autoimmunity screening was inconclusive (Table S2).

203 For dermatitis, all patients were treated with emollients and antihistamines, and some also  
204 received topical corticosteroids and topical tacrolimus with only moderate relief of symptoms.  
205 Patient IV-7 had previously been treated with several lines of immunosuppressants and  
206 biologic therapies for IBD/inflammatory rheumatism association (Table S1). Only infliximab  
207 led to a partial response of the inflammatory rheumatism, while both digestive and cutaneous  
208 involvements remained unchanged. Her father, patient III-6, had previously received  
209 adalimumab for oligoarthritis, which had no effect.

#### 210 **Genetic investigations**

211 Next generation sequencing in the proband, his brother and father using a panel for primary  
212 immunodeficiencies and revealed the presence of a heterozygous variant: c.2360 G>T;  
213 p.(Cys787Phe) in *JAK1* (NM\_002227.4). The variant was then confirmed using Sanger  
214 sequencing (Fig 2). This variant has not yet been implicated in a pathological condition and is  
215 absent from the human gene mutation database. Moreover, this variant was considered  
216 private to this family as it was not found in the public gnomAD 2.1.1 database. Subsequent  
217 targeted Sanger sequencing of *JAK1* gene in relatives revealed that all the tested affected  
218 subjects carried the same variant c.2360G>T in a heterozygous state, while the variant was  
219 absent in all the tested healthy siblings (Fig. 2A). The co-segregation of this variant with the  
220 clinical phenotype was fully consistent with the autosomal dominant inheritance model of the  
221 disease in this family. The variant leads to replacement of an evolutionary highly conserved  
222 cysteine and was predicted to be deleterious by all tested models. (Fig 2C). This amino acid is  
223 localized in the pseudokinase domain of JAK1, *i.e.* the domain affected by the three previously  
224 described GOF *JAK1* pathogenic variants (Fig 2D and S4A). Modelling of the impact of the  
225 variant on human JAK1 protein predicted that the phenylalanine residue in position 787  
226 formed new stabilizing interactions with Cys817 and Tyr788 (Fig. 2E).

227

228 **Patients with JAK1 pseudo kinase domain pathogenic variant Cys787Phe demonstrate**  
229 **altered JAK/STAT signaling.**

230 All tested patients demonstrated an upregulation of the Th1 (IL-12p70, IFN $\gamma$ ) and Th17 (IL-6,  
231 IL-12p19, IL-1 $\beta$ ) cytokines as well as increased IL-3, IL-33 and TSLP. Th2 cytokines IL-4, IL-13  
232 and IL-10 were significantly lower in the patients compared to healthy donors. (Fig 3A). Nine  
233 out of the 10 tested patients returned negative Type I interferon signature (16). III-13 was  
234 positive on a first occasion and negative on a second (Fig. S5 A, B, C and D). Targeted  
235 transcriptomic analysis of peripheral blood of 4 patients prior to treatment and 4 healthy  
236 donors, was performed using a panel of 750 immune genes. Again, no enrichment of a Type I  
237 interferon signature was observed. Most enriched pathways concerned over expression of  
238 genes related to JAKs/STATs (*JAK1*, *JAK2*, *JAK3*, *STAT3*, *STAT5b*) signaling (Figs. 3B and 3C).  
239 Consistently, immunochemistry analysis on ichthyosiform skin lesions from the patients  
240 revealed overexpression of STAT3 and JAK1 (Fig. 3D). Both JAK1 and STAT3 were also highly  
241 expressed in calcifying fibrous tumors of JAK1 patients but not in digestive biopsies (Fig. S2A  
242 and S2B).

243 Previously reported *JAK1* pseudokinase domain pathogenic variants led to aberrant STAT  
244 activation (12–14). While we noted high STATs activation in whole blood cells from V4, the  
245 phosphorylation status of STAT1, STAT3, STAT5 and STAT6 was comparable in the other tested  
246 patients to the levels observed in healthy donors for most cell types (Fig 4A, and Fig S6A) and  
247 no shared differences were observed across the 5 tested patients. Consistent results were  
248 found when studying basal STATs phosphorylation status in frozen PBMC by flow cytometry  
249 (Fig S6 B). To study JAK1 hyper and biased activation we stimulated PBMCs from patients with  
250 5 cytokines of which the receptors are known to signal via JAK1: IFN $\alpha$ , IFN $\gamma$ , IL-2, IL-4 and IL-6  
251 (Fig 4B and Fig S7). Heterogeneous results were observed when comparing the  
252 phosphorylation of the canonical STATs for each of these cytokines between patients and  
253 controls (IFN $\alpha$  and IFN $\gamma$  / STAT1, IL-2 / STAT5b, IL-4 / STAT6 and IL-6 / STAT3). Following IFN $\alpha$   
254 stimulation, STAT1 phosphorylation was higher in T cells from III-6, IV-5, IV-9 and II-16 than in  
255 T cells from 4 tested healthy donors. The same was true for B cells from patients IV-9 and II-  
256 16 and NK cells from patients IV-5, IV-9 and II-16. Similarly, STAT3 phosphorylation was higher  
257 in B cells, NK cells and monocytes from patients III-6 following IL-6 stimulation compared to  
258 healthy donors. Interestingly, PBMCs of 5 out of the 6 tested patients demonstrated hyper-

259 phosphorylation of STAT3 in response to stimulation with IFN- $\alpha$ 2 (Patients IV-7 and IV-9) or  
260 IL-2 (Patients III-6, IV-5 and V-1) when compared to PBMCs from healthy donors. PBMCs from  
261 Patients IV-7 and IV-9 also demonstrated hyper-phosphorylation of STAT5b under IFN- $\alpha$ 2  
262 stimulation (Fig. 4B). This atypical activation of STAT3 under IL-2 stimulation was confirmed in  
263 whole blood (Fig 4C) and appeared to predominantly affect NK cells (both CD56<sup>dim</sup> and CD56<sup>hi</sup>  
264 populations) (Fig 4C, S8A and S8B). Taken together, our *in vitro* and *ex vivo* experiments reveal  
265 a heterogeneous inflammatory profile between patients that converge towards an  
266 overexpression and an atypical activation of STAT3 in individuals bearing the JAK1<sup>Cys787Phe</sup>  
267 variant in this kindred.

268

### 269 **Patients with JAK1 pathogenic variant have an altered basophilic phenotype**

270 All patients displayed extremely high levels of blood histamine level and 6 out of 9 of them  
271 had mild basophilia. Comparison with 12 consecutive patients with familial Mediterranean  
272 fever, 10 consecutive patients with moderate-to-severe atopic dermatitis and 10 consecutive  
273 all-coming patients seen for routine outpatient clinical exams confirmed a significant elevation  
274 of basophils in JAK1<sup>Cys787Phe</sup> patients' blood (Fig. 5A). This basophilic expansion was also  
275 observed at the transcriptomic level. Indeed, differential gene expression analysis from  
276 peripheral blood of 4 untreated patients compared to healthy donors revealed a basophilic  
277 signature defined by the over expression of *IL4*, *MS4A2*, *HDC* and *CPA3*. (Fig. 5B). Histamine  
278 levels was quantified in sorted leukocyte populations from affected individuals and HD  
279 showing that basophils contained the largest amount (Fig. 5C). No significant variation in the  
280 cellular histamine content between affected individuals and HD including basophils was  
281 detected (Fig. 5D). Altogether, this suggests that the high blood histamine levels observed in  
282 JAK1<sup>Cys787Phe</sup> patients mostly results from a mild chronic basophil expansion. In order to test  
283 the activation status of circulating basophils we looked at the expression of the following  
284 activation markers: CD63, CD69; CD107a, CD193 and CD203c. None of these markers were  
285 over expressed on basophils from tested patients compared to healthy donors (Fig 5E).

286

### 287 **Treatment with baricitinib**

288 Considering their previously reported efficacy in patients with *JAK1*-pseudokinase domain-  
289 GOF variants (12,13), and their indication in atopic dermatitis (17,18), JAK inhibitors were  
290 considered for the treatment of our patients. Baricitinib was first tested because of the  
291 availability of pharmacokinetic data in children (19). Six adults (II-16, III-4, III-6, III-13, IV-5 and  
292 IV-7) and 1 child (V-1) received baricitinib at a dose of 4 and 2 mg once daily respectively. All  
293 adults displayed a dramatic skin improvement within a few days following the treatment  
294 introduction. Beyond the complete resolution of almost all symptoms related to atopic  
295 dermatitis, ichthyosiform lesions gradually improved leading to a drastic reduction in the daily  
296 usage of emollient cream and ultimately to a better quality of life (Figs. 6A and 6B and S9).  
297 Three out of four patients with chronic diarrhea and two out of three with arthromyalgia  
298 experienced substantial improvement of their symptoms. Calcifying fibrous tumors, however,  
299 did not regress under baricitinib. V-1, the only treated child, displayed a less positive response  
300 with slightly improved ichthyosis and persistent atopic features (Fig. 6B). Moreover, baricitinib  
301 did not restore normal ponderal and statural growth.

302 Inflammatory phenotype modifications with baricitinib treatment were assessed *ex vivo* and  
303 *in vitro*. Under baricitinib, all the elevated cytokines decreased except for the V-1 patient.  
304 Similarly, IL-4, IL-10 and IL-13 plasmatic levels increased (Fig. 6C , Fig S10 and Table S3). The  
305 blood transcriptional analysis under baricitinib treatment revealed a loss of all the previously  
306 enriched gene sets related to JAKs/STATs signaling (Fig. S11). *In vitro*, baricitinib achieved a  
307 good control of the STAT3 and STAT5b atypical activation following IFN  $\alpha$ 2 stimulation (Fig.  
308 S12). However, STAT3 hyper-phosphorylation following IL-2 stimulation was poorly controlled  
309 *in vitro* by the treatment.

310 Interestingly, despite clinical improvement of atopic features in adults, neither blood  
311 histamine levels nor basophilia decreased under baricitinib treatment (Fig. S13A). Accordingly,  
312 differential gene expression analysis in whole blood showed a persistent basophilic  
313 transcriptional signature (Fig. S13B).

314 Thus, treatment with baricitinib substantially attenuated the clinical manifestations of the  
315 disease and reverted most of the cellular and molecular inflammatory phenotypes driven by  
316 *JAK1*<sup>Cys787Phe</sup>.

317

### 318 **Treatment with upadacitinib**

319 Although clinically effective, treatment with baricitinib was not sufficient to fully control all  
320 symptoms of the disease. Upadacitinib, a specific JAK1 inhibitor, was tested in 4 adult patients  
321 (III-4, III-6, IV-5 and IV-7) and was able to control canonical STAT1 and STAT5 activation  
322 following IFN $\alpha$  and IL-2 stimulation of patients' whole blood (Fig S14). Cutaneous and articular  
323 involvements worsened in 3 (III-6, IV-7 and III-4) and 2 (IV-7 and III-4) patients respectively.  
324 Two patients who displayed persistent gastrointestinal manifestations under baricitinib (III-6  
325 and IV-7) experienced a substantial reduction of stool frequency and abundance with  
326 upadacitinib. (Fig. S15) Overall, due to the dissociated response under upadacitinib, patients  
327 III-6, IV-7 and III-4 were switched back to baricitinib; while only patient IV-5 remained under  
328 upadacitinib. He displayed an overall diminution of most inflammatory cytokine levels under  
329 upadacitinib compared to baricitinib (Fig S16). After resuming treatment with baricitinib,  
330 cutaneous (III-6, IV-7 and III-4) and articular (IV-7 and III-4) symptoms improved again.

331

### 332 **Discussion**

333 We report a large French family displaying a complex immune dysregulation syndrome with  
334 predominant cutaneous involvements perfectly segregating with the heterozygous *JAK1*:  
335 p.Cys787Phe variant. The main features, mostly related to atopy and/or autoinflammation,  
336 are close to what has been reported in the previously described *JAK1* pathogenic variants (12–  
337 14). This large family with this novel *JAK1* pathogenic variant harbors some specific features  
338 such as diffuse ichthyosiform skin rash, very high blood histamine levels associated with mild  
339 basophilia and multiple profound benign calcified tumours. These clinical and biological  
340 specificities are simple to identify on clinical examination or through blood sampling and could  
341 constitute markers indicative of JAK1-associated inflammatory disease (JAID) for the clinician.  
342 As a result, we expect them to be valuable in guiding the clinical diagnosis of a JAID among  
343 patients with familial atopic dermatitis/ichthyosis.

344 Our observation highlights that the clinical heterogeneity reported in patients with *JAK1* GOF  
345 variants is mirrored by a variable dysregulation of the JAK/STAT signalling pathway. Indeed,  
346 despite careful assessment using three different assays, and in contrast to the patient with  
347 the S703I mosaic, we did not observe any consistent type I IFN signature in our family. This is  
348 reminiscent of what is observed in STAT1 GOF variants, in which type I interferon signature is

349 variably present across patients or variants (20). Increase of the constitutive basal activation  
350 of the JAK/STAT signalling pathway was variable across patients. Cytokine-induced  
351 hyperphosphorylation of canonical JAK/STAT pathways was variably observed across patients,  
352 in opposition to previous report on patients with A634D and 703I *JAK1* GOF variants (12,13).  
353 This discrepancy might be partly explained by the larger group of patients and controls (healthy  
354 donors) used in our study compared to the previous reports, better encompassing the inter-  
355 individual variability of both control and patient groups. Together, our observation of  
356 JAK/STAT signalling in our patients imply that lack of type I interferon signature and more  
357 generally lack of over activation of canonical JAK/STAT pathway should not be considered as  
358 excluding criteria for *JAK 1* GOF diagnosis.

359 Besides this clinical and molecular heterogeneity, there are compelling associations pointing  
360 toward a common pathophysiology. The first are the above-mentioned shared clinical  
361 features, which mainly consist in atopic manifestations such as atopic dermatitis, food allergy,  
362 asthma, and eosinophilia (Fig. S17). The second is the existence of common dysregulations of  
363 the STATs phosphorylation by JAKs in patients with a *JAK1* GOF variant. Indeed, as for *JAK1*  
364 S703I mosaic variant, we observed a consistent atypical phosphorylation of STAT3 and STAT5b  
365 in cells from patients with the Cys787Phe pathogenic variant. This finding is highly consistent  
366 with the phenotypic overlap of *JAK1* associated disease with manifestations observed in  
367 patients with *STAT3* and *STAT5b* GOF pathogenic variants (21,22) (Table 2).

368 It might be important however to highlight that we observed a trend toward  
369 hyperphosphorylation of STAT6 following IL-4 treatment. Given the clinical overlap of *STAT6*  
370 GOF (23–25) patients with *JAK1* GOF patients (Table2), it is reasonable to speculate that  
371 hyperphosphorylation of *STAT6* might contribute to the allergic manifestation in *JAK1* GOF  
372 patients.

373 Baricitinib treatment resulted in a major improvement of most of atopic and inflammatory  
374 manifestations among adults, especially ichthyosis-related and atopic dermatitis-related  
375 symptom, achieving a substantial improvement of quality of life. This good clinical response  
376 was consistent with the partial correction or normalization of all dysregulated cytokines and  
377 the extinction of the JAKs/STATs signaling transcriptomic signatures. However, in some  
378 patients, treatment with baricitinib was not sufficient to fully control digestive and articular  
379 features leading us to switch to upadacitinib, a selective *JAK1* inhibitor, in 4 patients. Digestive  
380 manifestations improved (n=2), however skin and/or articular involvements worsened (n=3).

381 As suggested *in vitro* (13), our results support that selective JAK1 inhibition might not be an  
382 optimal therapeutic approach in patients with *JAK1* associated disease. Indeed, it remains  
383 unclear how a variant in the JAK1 pseudokinase domain could lead to atypical STAT3 and  
384 STAT5b activation. To date, the function of JAK1 pseudokinase domain in the overall protein  
385 function, including regulation of the catalytic activity or binding/recruitment of signalling  
386 partners, remains largely unknown (26). Disease-causing variants of the *JAK1* pseudokinase  
387 domain could favour JAK2 trans-activation. This hypothesis is partly supported by our  
388 observations that in most patients the disease was better controlled by the JAK1/JAK2  
389 inhibitor baricitinib than by the selective JAK1 inhibitor upadacitinib.

390 Interestingly, AD was a common feature of our patients, suggesting that JAK1 dysregulation  
391 might account for some common forms of AD. The spectacular efficacy of baricitinib on our  
392 patients' dermatitis suggest that a proportion of AD patients with altered JAK1 signalling  
393 would have particularly high benefit from this therapy.

394 Despite the above-mentioned efficacy of JAKinibs to treat skin atopic manifestations, both  
395 baricitinib and upadacitinib failed to control the basophilic signature of the disease, suggesting  
396 a pathway independent of JAK1/2 kinase activity might drive this basophilia. Thus, the precise  
397 basophil contribution to the disease pathogenesis is not yet elucidated. One child received  
398 baricitinib resulting in decreased pruritus and better sleep without improvement of his food  
399 allergy. The treatment improved the skin involvement. However, considering the potential  
400 risk on growth due to blocking of growth hormone signalling, baricitinib was discontinued.

401

402 The description of this large family with inherited JAID expands the clinical spectrum of the  
403 disease and can guide the future diagnosis of such patients. Two years follow-up of our  
404 patients under baricitinib treatment reveals a clear benefit of JAK1 and JAK2 inhibition for the  
405 control of most disease manifestation. Finally, the clinical response to various JAK inhibitor  
406 treatment regimens of JAID patients provides useful information on their benefits among  
407 patients suffering from more common diseases such as atopic dermatitis, chronic  
408 inflammatory rheumatism, or inflammatory bowel diseases.

409

410

411 **Authors contributions**

412 MPR and SGL conceived and designed the study. AF, MPR and SGL wrote the paper. VH and  
413 JML contributed to writing the paper. AF, CPo, AC, CLL, JLC, SD, MF, BH, PM, MP, JML, JC, NS,  
414 YYJZ, SM and MPR performed experiments, AF, CPo, AC, CLL, MC, MM, SD, MF, LLC, TRJM, PM,  
415 CPi, SV, DD, JML, JC, JPH, MPR, NS, YYJZ, SM, AH, RRB, TTM and SGL performed data analysis.  
416 AF, VH, CL, JDK, VL, TM, MHS, SGL were involved in the clinical study and sample collection.  
417 All authors reviewed the manuscript and gave final approval for the version to be published.  
418 All authors agree to be accountable for all aspects of the work in ensuring that questions  
419 related to the accuracy or integrity of any part of the work are appropriately investigated and  
420 resolved.

421

#### 422 **Acknowledgments**

423 We thank all the affected patients and their family, and the healthy individuals used as  
424 controls, researchers from Inserm UMRS\_933 laboratory for helping with the identification of  
425 the mutation, Mr Benjamin SaintPierre and Ms Lucie Adoux from the Genomic platform of  
426 Cochin Institute for their precious help in producing/analysing the data, the CBUtechS  
427 platform of the Institut Pasteur for supporting generation of Nanostring data, Dr. Lauriane  
428 Goldwirt for performing baricitinib blood assay in treated patients, the cyto2BM core facility  
429 of BioMedTech Facilities INSERM US36 | CNRS UAR20 for helping with flow cytometry  
430 experiment ~~and~~, the Agence Régional de Santé Île-de-France and les hôpitaux universitaires  
431 de Strasbourg for supporting the project with the “bourse année-recherche” educational  
432 grant and “la Fondation pour la Recherche Medical” for providing the Ph.D scholarship of  
433 Margaux Cescato.

434

435 **Competing interests** : none

436

#### 437 **Funders**

438 SGL: ANR INFLAMAST AAPG 2017 CE17 and foundation APHP.

439 MPR was supported by the Agence National de la Recherche: ANR-21-CE17-0025 JDMINF2.

440

#### 441 **Data Availability**

442 The datasets generated during and/or analysed during the current study are available from  
443 the corresponding author on reasonable request.

444

445

446



- 448 1. Boisson B, Quartier P, Casanova J-L. Immunological loss-of-function due to genetic  
449 gain-of-function in humans: autosomal dominance of the third kind. *Curr Opin*  
450 *Immunol.* 2015 Feb;32:90–105.
- 451 2. Notarangelo LD, Bacchetta R, Casanova J-L, Su HC. Human inborn errors of immunity:  
452 An expanding universe. *Sci Immunol.* 2020 Jul 10;5(49).
- 453 3. Tangye SG, Al-Herz W, Bousfiha A, Chatila T, Cunningham-Rundles C, Etzioni A, et al.  
454 Human Inborn Errors of Immunity: 2019 Update on the Classification from the  
455 International Union of Immunological Societies Expert Committee. *J Clin Immunol.*  
456 2020 Jan 17;40(1):24–64.
- 457 4. Tangye SG, Al-Herz W, Bousfiha A, Cunningham-Rundles C, Franco JL, Holland SM, et al.  
458 The Ever-Increasing Array of Novel Inborn Errors of Immunity: an Interim Update by  
459 the IUIS Committee. *J Clin Immunol.* 2021 Feb 18;
- 460 5. Hadjadj J, Frémond M-L, Neven B. Emerging place of JAK inhibitors in the treatment of  
461 inborn errors of immunity. *Front Immunol.* 2021 Sep 17;12:717388.
- 462 6. Lin B, Goldbach-Mansky R. Pathogenic insights from genetic causes of  
463 autoinflammatory inflammasomopathies and interferonopathies. *J Allergy Clin*  
464 *Immunol.* 2021 Dec 7;
- 465 7. Lamb CA, Kennedy NA, Raine T, Hendy PA, Smith PJ, Limdi JK, et al. British Society of  
466 Gastroenterology consensus guidelines on the management of inflammatory bowel  
467 disease in adults. *Gut.* 2019 Dec;68(Suppl 3):s1–s106.
- 468 8. Fraenkel L, Bathon JM, England BR, St Clair EW, Arayssi T, Carandang K, et al. 2021  
469 american college of rheumatology guideline for the treatment of rheumatoid arthritis.  
470 *Arthritis Care Res (Hoboken).* 2021 Jul;73(7):924–939.
- 471 9. Chovatiya R, Paller AS. JAK inhibitors in the treatment of atopic dermatitis. *J Allergy*  
472 *Clin Immunol.* 2021 Oct;148(4):927–940.
- 473 10. Morris R, Kershaw NJ, Babon JJ. The molecular details of cytokine signaling via the  
474 JAK/STAT pathway. *Protein Sci.* 2018 Dec;27(12):1984–2009.
- 475 11. Biggs CM, Cordeiro-Santanach A, Prykhozhiy SV, Deveau AP, Lin Y, Del Bel KL, et al.  
476 Human JAK1 gain of function causes dysregulated myelopoiesis and severe allergic  
477 inflammation. *JCI Insight.* 2022 Dec 22;7(24).
- 478 12. Del Bel KL, Ragothe RJ, Saferali A, Lee S, Vercauteren SM, Mostafavi SA, et al. JAK1 gain-  
479 of-function causes an autosomal dominant immune dysregulatory and  
480 hypereosinophilic syndrome. *J Allergy Clin Immunol.* 2017 Jun;139(6):2016–2020.e5.
- 481 13. Gruber CN, Calis JJA, Buta S, Evrony G, Martin JC, Uhl SA, et al. Complex  
482 autoinflammatory syndrome unveils fundamental principles of JAK1 kinase  
483 transcriptional and biochemical function. *Immunity.* 2020 Sep 15;53(3):672–684.e11.
- 484 14. Takeichi T, Lee JYW, Okuno Y, Miyasaka Y, Murase Y. Autoinflammatory keratinization  
485 disease with hepatitis and autism reveals roles for JAK1 kinase hyperactivity in  
486 autoinflammation. *Frontiers in Immunology.* 2021;12:737747
- 487 15. Fusaro M, Rosain J, Grandin V, Lambert N, Hanein S, Fournage C, et al. Improving the  
488 diagnostic efficiency of primary immunodeficiencies with targeted next-generation  
489 sequencing. *J Allergy Clin Immunol.* 2021 Feb;147(2):734–737.
- 490 16. Rice GI, Forte GMA, Szykiewicz M, Chase DS, Aeby A, Abdel-Hamid MS, et al.  
491 Assessment of interferon-related biomarkers in Aicardi-Goutières syndrome associated

- 492 with mutations in TREX1, RNASEH2A, RNASEH2B, RNASEH2C, SAMHD1, and ADAR: a  
493 case-control study. *Lancet Neurol*. 2013 Dec;12(12):1159–1169.
- 494 17. He H, Guttman-Yassky E. JAK inhibitors for atopic dermatitis: an update. *Am J Clin*  
495 *Dermatol*. 2019 Apr;20(2):181–192.
- 496 18. Guttman-Yassky E, Silverberg JI, Nemoto O, Forman SB, Wilke A, Prescilla R, et al.  
497 Baricitinib in adult patients with moderate-to-severe atopic dermatitis: A phase 2  
498 parallel, double-blinded, randomized placebo-controlled multiple-dose study. *J Am*  
499 *Acad Dermatol*. 2019 Apr;80(4):913–921.e9.
- 500 19. Kim H, Brooks KM, Tang CC, Wakim P, Blake M, Brooks SR, et al. Pharmacokinetics,  
501 pharmacodynamics, and proposed dosing of the oral JAK1 and JAK2 inhibitor  
502 baricitinib in pediatric and young adult CANDLE and SAVI patients. *Clin Pharmacol*  
503 *Ther*. 2018 Aug;104(2):364–373.
- 504 20. Scott O, Lindsay K, Erwood S, Mollica A, Roifman CM, Cohn RD, et al. STAT1 gain-of-  
505 function heterozygous cell models reveal diverse interferon-signature gene  
506 transcriptional responses. *NPJ Genom Med*. 2021 May 14;6(1):34.
- 507 21. Flanagan SE, Haapaniemi E, Russell MA, Caswell R, Allen HL, De Franco E, et al.  
508 Activating germline mutations in STAT3 cause early-onset multi-organ autoimmune  
509 disease. *Nat Genet*. 2014 Aug;46(8):812–814.
- 510 22. Ma CA, Xi L, Cauff B, DeZure A, Freeman AF, Hambleton S, et al. Somatic STAT5b gain-  
511 of-function mutations in early onset nonclonal eosinophilia, urticaria, dermatitis, and  
512 diarrhea. *Blood*. 2017 Feb 2;129(5):650–653.
- 513 23. Sharma M, Leung D, Momenilandi M, Jones LCW, Pacillo L, James AE, et al. Human  
514 germline heterozygous gain-of-function STAT6 variants cause severe allergic disease. *J*  
515 *Exp Med*. 2023 May 1;220(5).
- 516 24. Takeuchi I, Yanagi K, Takada S, Uchiyama T, Igarashi A, Motomura K, et al. STAT6 gain-  
517 of-function variant exacerbates multiple allergic symptoms. *J Allergy Clin Immunol*.  
518 2022 Dec 17;
- 519 25. Baris S, Benamar M, Chen Q, Catak MC, Martínez-Blanco M, Wang M, et al. Severe  
520 allergic dysregulation due to A gain of function mutation in the transcription factor  
521 STAT6. *J Allergy Clin Immunol*. 2023 Feb 7;
- 522 26. Raivola J, Haikarainen T, Silvennoinen O. Characterization of JAK1 pseudokinase  
523 domain in cytokine signaling. *Cancers (Basel)*. 2019 Dec 27;12(1).
- 524
- 525

526

527 **Figure 1: Clinical findings.**

528 **A:** Bilateral cheek involvement of severe atopic dermatitis-like inflammatory skin lesions in  
529 patient V-1. **B:** Inflammatory Linear Verrucous Papules of the forearm in patient IV-5. **C:**  
530 Extensive ichthyosiform skin lesions of the breast and forearm in patient II-16. **D:** Digital  
531 recurrent warts in patient IV-7. **E:** Sagittal reconstruction of patient IV-5 CT-scan showing  
532 multiple calcified nodules of both thoracic and abdominal cavities, including a voluminous  
533 lesion of the lower esophagus responsible for dysphagia

534

535 **Figure 2: Variant in JAK1 pseudokinase domain.**

536 **A:** Pedigree of the family. Solid symbols indicate affected individuals, open symbols:  
537 unaffected individuals, asterisk: genotyped individuals, arrow: proband, slashes: deceased  
538 individuals. Non-genotyped individuals were considered to be affected if they displayed early  
539 onset dermatitis. JAK1-Cys787Phe variant was found in all tested symptomatic individuals and  
540 in none of the clinically asymptomatic relatives. **B:** Electropherogram of patient V-1 and  
541 healthy relative IV-11. **C:** Alignment of JAK1 homologs illustrates the strict evolutionary  
542 conservation of the Cysteine in position 787. **D:** Representation of the JAK1 domains with  
543 localizations of known inflammatory disease-causing variants of the pseudokinase domain. **E:**  
544 Prediction of the impact of the variant on the interactions between the residue in position 787  
545 and other residues.

546

547

548 **Figure 3: Patients demonstrate systemic and local inflammation.**

549 **A)** Representation of the plasmatic concentration of various cytokines in the plasma of healthy  
550 donors and JAK1 patients. Results are presented as log<sub>2</sub> fold change normalized on the mean  
551 of the healthy donors. **B)** Significantly enriched pathways in patients compared to healthy  
552 donors identified by gene set enrichment analysis from transcriptomic study on whole blood.  
553 **C)** Detail of the genes from the identified pathways. **D)** JAK1 and STAT3 immunostaining of a  
554 normal skin biopsy from a healthy donor and an ichthyous skin biopsy from patient III-13

555 (magnification x400). JAK1 cytoplasmic overexpression of the entire epidermis and STAT3  
556 nuclear overexpression of the upper part of the epidermis were observed in the patient's skin.

557

558 **Figure 4: Dysregulated phosphorylation of STAT3 in patient's cells.**

559 A). Bar graph showing the phosphorylation of STAT3 in unstimulated fresh whole blood from  
560 4 donors and 5 untreated patients. For IV-7 : Baricitinib discontinuation >72h. B)  
561 Phosphorylation status of STAT1, STAT3, STAT5b and STAT6 was measured by flow cytometry  
562 on frozen PBMCs from 4 healthy donors and 6 patients stimulated with IFN- $\alpha$ 2 (100 UI/mL)  
563 and IL-2 (50 ng/mL) C) STAT3 phosphorylation in response to IL-2 assessed by mass cytometry  
564 in blood leukocyte subsets from 3 healthy donors (left) and patient IV-7 (right). Each solid  
565 circle indicates a cluster. Circle diameter indicates cluster's relative frequency in the sample(s).  
566 The continuous color scale depicts the fold change of pSTAT3 mean signal intensity after IL-2  
567 stimulation, compared to baseline pSTAT3 signal intensity assessed in non-stimulated  
568 conditions.

569

570 **Figure 5: Moderate basophilia in JAK1<sup>C787F</sup> patients.**

571 A) Quantification of circulating basophils in 7 JAK1<sup>C787F</sup> patients, 10 patients with atopic  
572 dermatitis (AD), 12 patients with familial Mediterranean fever (FMF) and 10 consecutive all-  
573 coming patients. B) Volcano plot representation of the gene expression analysis comparing  
574 patients to healthy donors. *IL4*, a cytokine gene known to be largely expressed in basophils,  
575 and 3 of the 4 basophilic genes included in the transcriptomic panel (*MS4A2*, *HDC* and *CPA3*)  
576 were among the 7 top upregulated genes in JAK1-Cys787Phe patients. C) Intracellular  
577 histamine quantification in circulating leukocyte subsets from patients and healthy donors. D)  
578 Intracellular histamine quantification in circulating basophils from patients and healthy  
579 donors. E) Evaluation by flow cytometry of the expression of activation markers by basophils  
580 from patients and healthy donors.

581

582 **Figure 6: Response to baricitinib.**

583 **A)** Three key cutaneous manifestations from two patients are presented before (top) and  
584 during treatment with baricitinib (bottom). From left to right: improvement of atopic  
585 dermatitis-like lesions of the face in patient III-4 (I); improvement of the inflammatory linear  
586 verrucous papules of patient IV-5's forearm (II); and near disappearance of xerosis and  
587 lichenification of ichthyosiform atopic dermatitis lesions on patient III-4's hand (III). **B)** Effect of  
588 baricitinib on the articular, gastrointestinal, and skin involvements using a subjective clinical  
589 scale ranging from 0 (no activity) to 5 (severe involvement). **C)** Plasmatic concentration of  
590 cytokines in patients before and under treatment with baricitinib. All patients had a partial or  
591 total improvement of cytokine levels except V-1.  
592

593 **Table 1:**  
 594 Summary of the manifestations of the JAK1-associated autoinflammatory disease in this  
 595 family.  
 596 ENT: ear-nose-throat  
 597 \* all adult patients, children did not undergo systematic CT scans  
 598

	<b>Main features</b>	<b>Frequency no./total no</b>
<b>Allergy</b>	Ichthyosis	9/9
	Atopic dermatitis	9/9
	Elevated blood histamine level	9/9
	Moderate basophilia	6/9
	Moderate eosinophilia	5/9
	High total IgE	5/9
<b>Inflammation</b>	Arthralgia	6/9
	Mild inflammatory syndrome	7/9
<b>Immune deficiency</b>	Recurrent ENT infections	5/9
	Susceptibility to warts	4/9
	Mild hypogammaglobulinemia	5/4/9
<b>Other</b>	Calcifying fibrous tumors	7/7*
	Diarrhea	5/9
	Short stature / failure to thrive	5/9

599  
 600

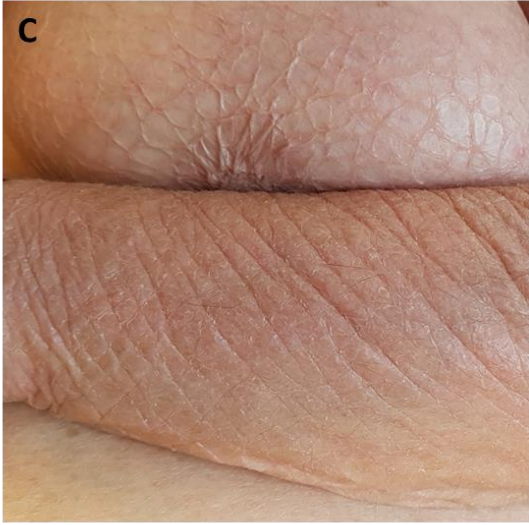
601  
602  
603

**Table 2**

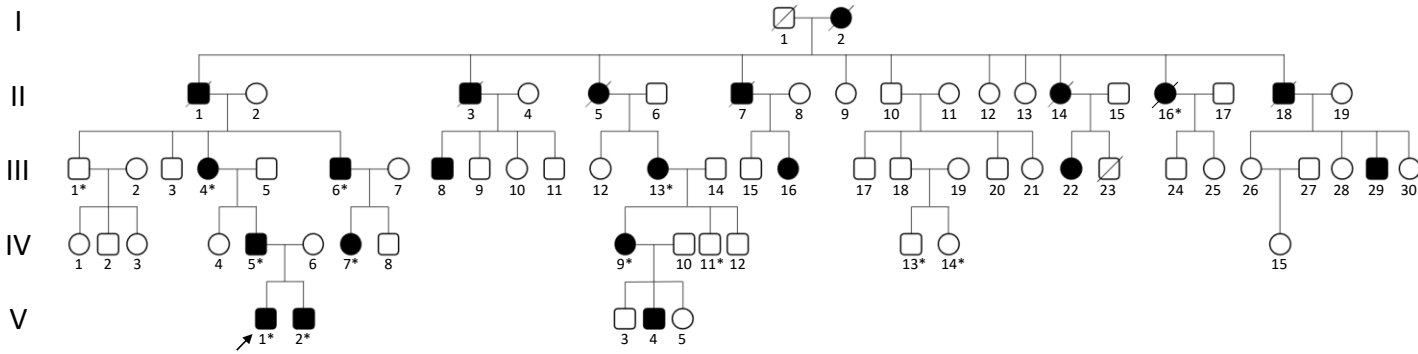
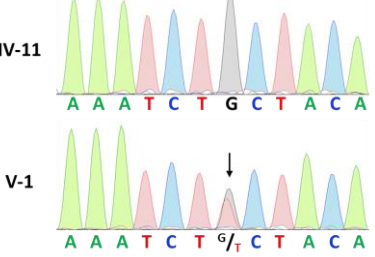
	JAK1-Cys787Phe	STAT3 AD GOF <sup>§</sup>	STAT5b AD GOF <sup>£*</sup>	STAT6 AD GOF <sup>€</sup>	JAK3 AD GOF <sup>&amp;</sup>	
<b>Onset</b>	Neonatal	Childhood	Neonatal	Early childhood	?	
<b>Failure to thrive / short stature</b>	+	+	+	+	?	
<b>Atopy</b>	<b>Atopic dermatitis</b>	+	+	+	-	
	<b>Food allergies</b>	+	-	+	-	
	<b>Asthma</b>	+	-	+	-	
	<b>Eosinophil count</b>	Moderately elevated	Normal	High	High	-
	<b>Eosinophilic GI disease</b>	-	-	+	+	-
	<b>Basophilia</b>	+	-	-	-	-
	<b>Hyper-IgE</b>	+	-	+	+	-
<b>Auto-immunity / inflammation</b>	<b>Enteropathy / IBD</b>	+/-	+	-	-	
	<b>Arthritis</b>	+	+	-	-	
	<b>Autoimmune cytopenia</b>	-	+	-	-	+
	<b>Interstitial lung disease</b>	-	+	-	-	-
	<b>Endocrinopathies</b>	Addison's disease	T1D, thyroiditis	-	-	-
<b>Imm. def.</b>	<b>Hypogammaglobulinemia</b>	+/-	+/-	-	+/-	+
	<b>Infection susceptibility</b>	Mild	+	-	+	+
	<b>Warts</b>	+	-	-	-	-
<b>Onco-hemato.</b>	<b>Lymphadenopathy</b>	+/-	+	-	-	+
	<b>Hepatosplenomegaly</b>	-	+	-	-	+
	<b>Multiple CFT</b>	+	-	-	-	-
	<b>Risk of malignancy</b>	?	+	?	?	?
<b>Other feature(s)</b>	Ichthyosis, CFT, Diarrhea of uncertain cause	-	-	-	CLPD-NK	

604  
605  
606  
607  
608  
609  
610  
611

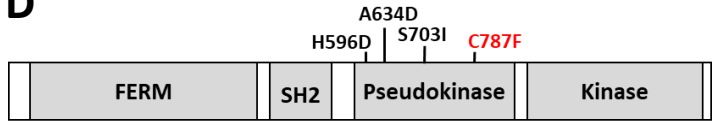
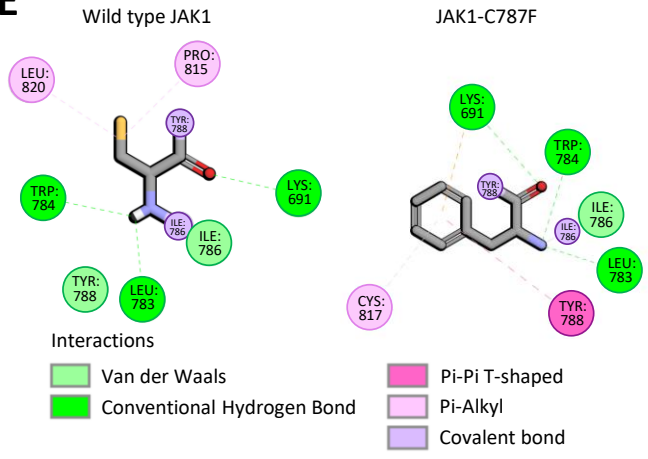
T1D: Type-1 diabetes melitus; Imm. def.: immune deficiency; CFT: calcifying fibrous tumors; onco-hemato.: onco-hematological features.  
GI: gastro intestinal; IBD : intestinal bowel disease  
§: adapted from Fabre *et al. J Allergy Clin Immunol Pract* 2019  
£: adapted from Ma *et al. Blood* 2017 ; \*: somatic mutation  
€: adapted from Sharma *et al. J Exp Med* 2023  
&: adapted from Lesmana *et al. Blood* 2020

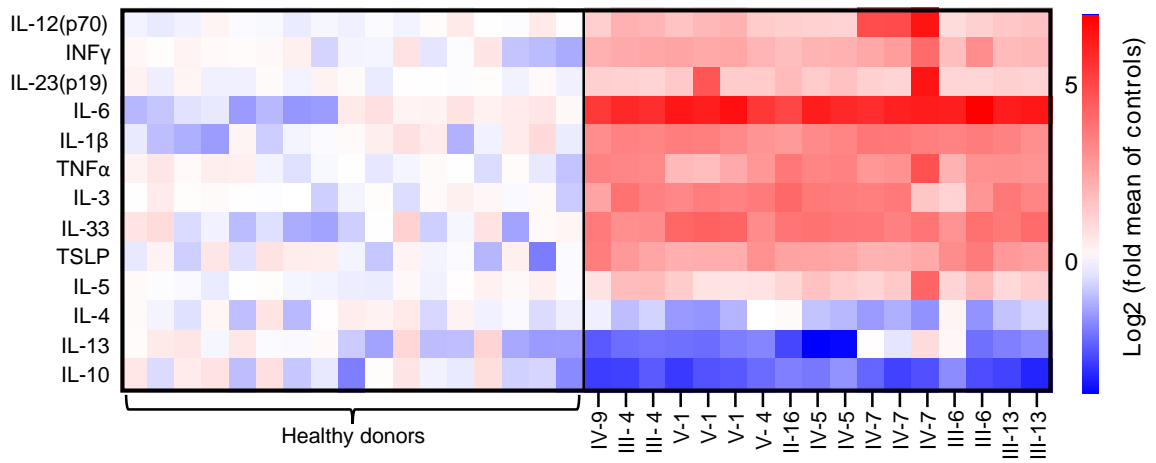
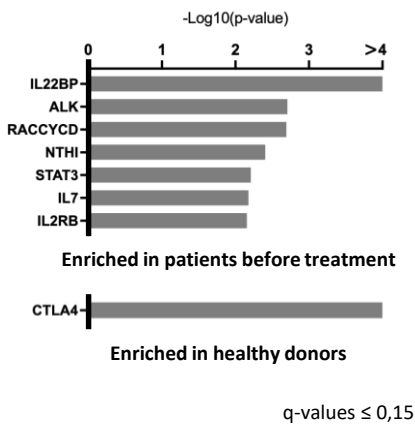
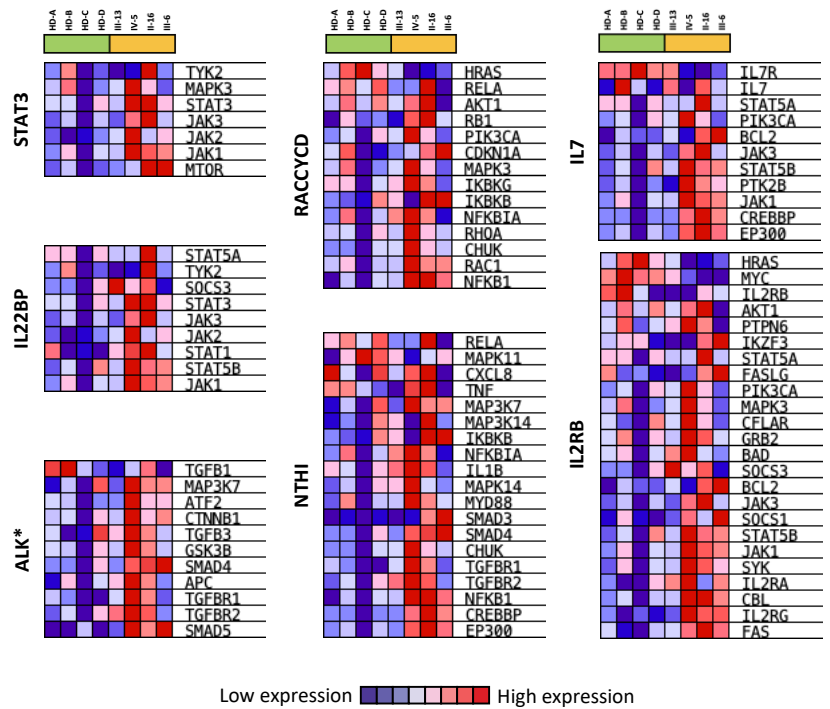




**A****B****C**

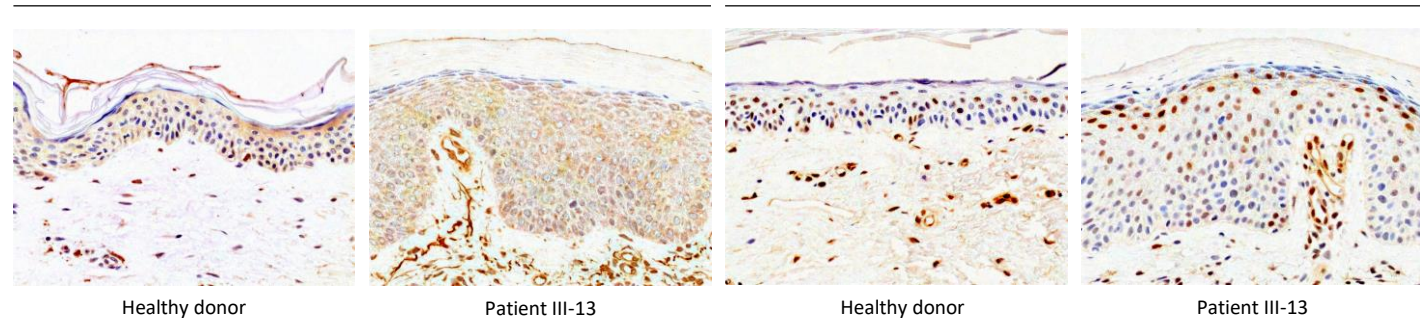
Species	Sequence
<i>H sapiens</i>	TLWEIC <b>787</b> CYNGEIPLK
<i>P troglodytes</i>	TLWEIC <b>787</b> CYNGEIPLK
<i>M Mulatta</i>	TLWEIC <b>787</b> CYNGEIPLK
<i>B taurus</i>	TLWEIC <b>787</b> CYNGEIPLK
<i>S scrofa</i>	TLWEIC <b>787</b> CYNGEIPLK
<i>M musculus</i>	TLWEIC <b>787</b> CYNGEIPLK
<i>R. norvegicus</i>	TLWEIC <b>787</b> CYNGEIPLK
<i>G gallus</i>	TLWEIC <b>787</b> CYNGETPLK
<i>X tropicalis</i>	TLWEIC <b>787</b> CYNGEVPLK
<i>D rerio</i>	TLWEIC <b>787</b> CYNGEIPLK

**D****E**

**A****B****C****D**

Anti-JAK1

Anti-STAT3



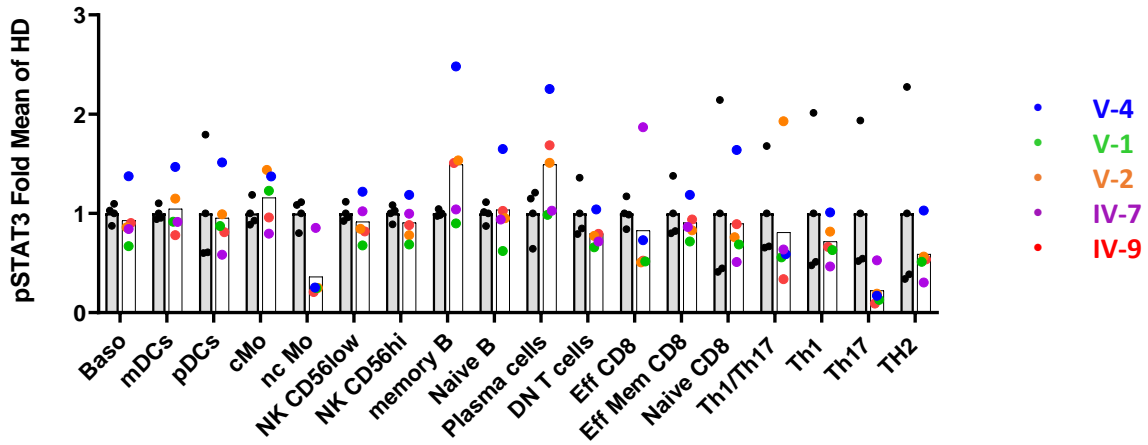
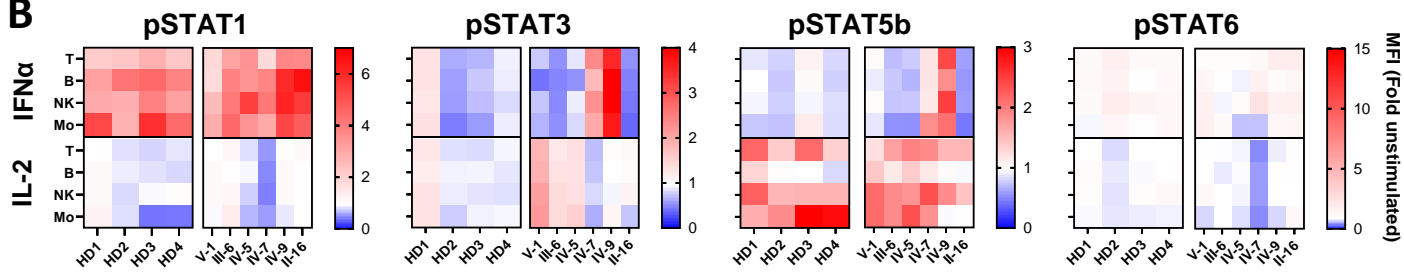
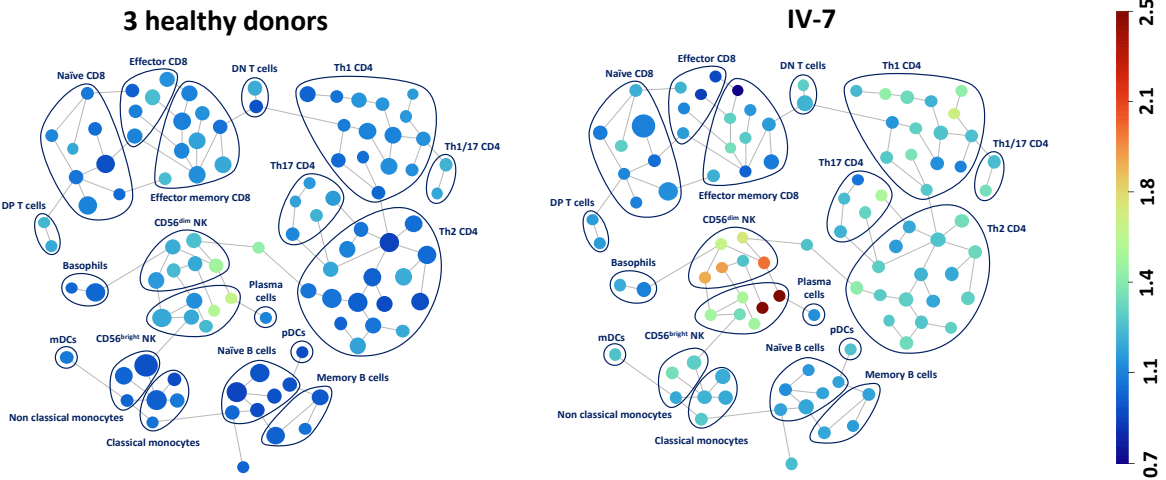
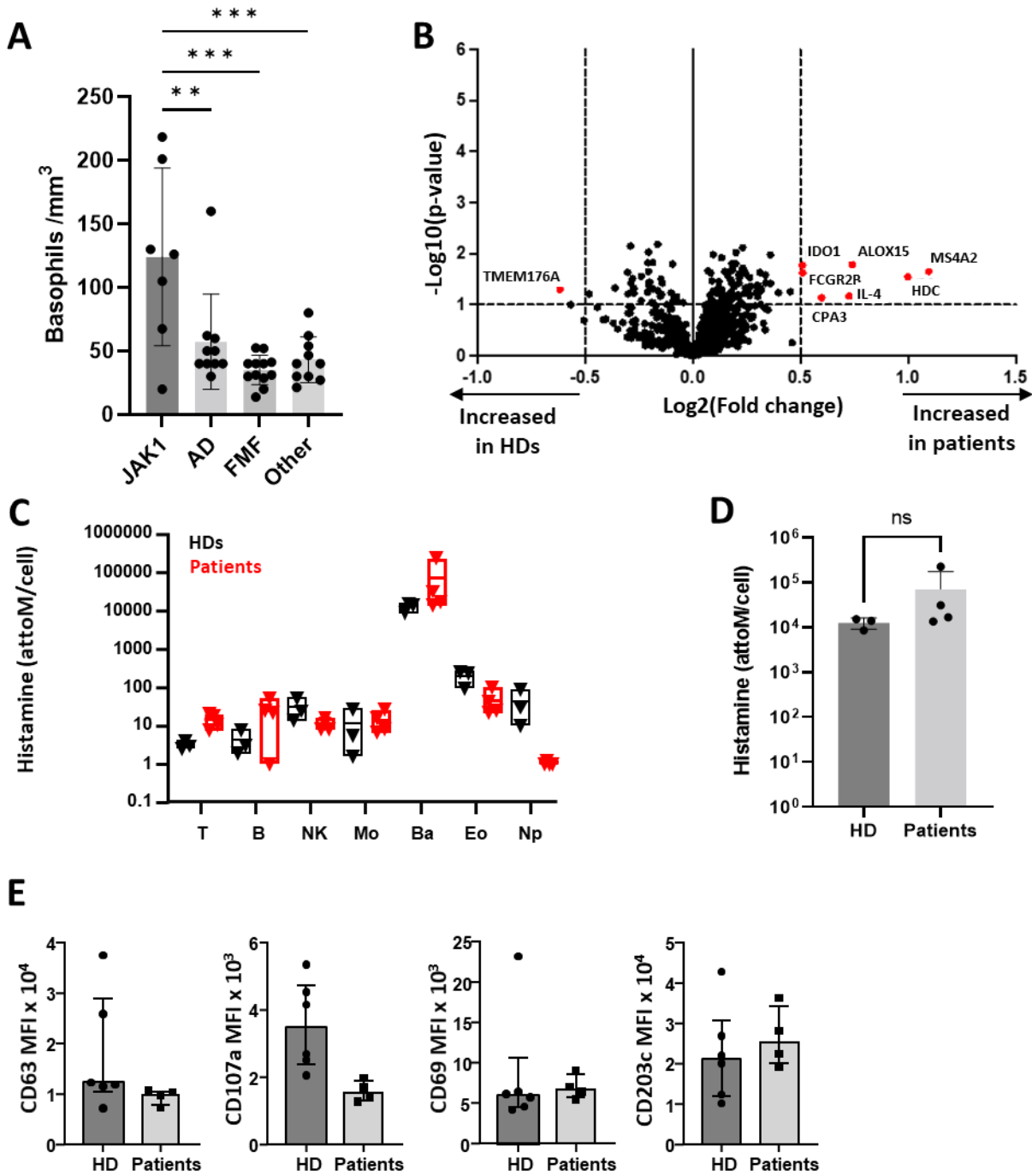
**A****B****C**

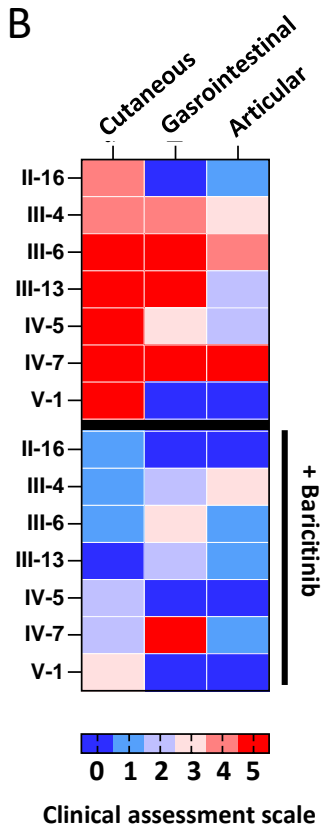
Figure 5



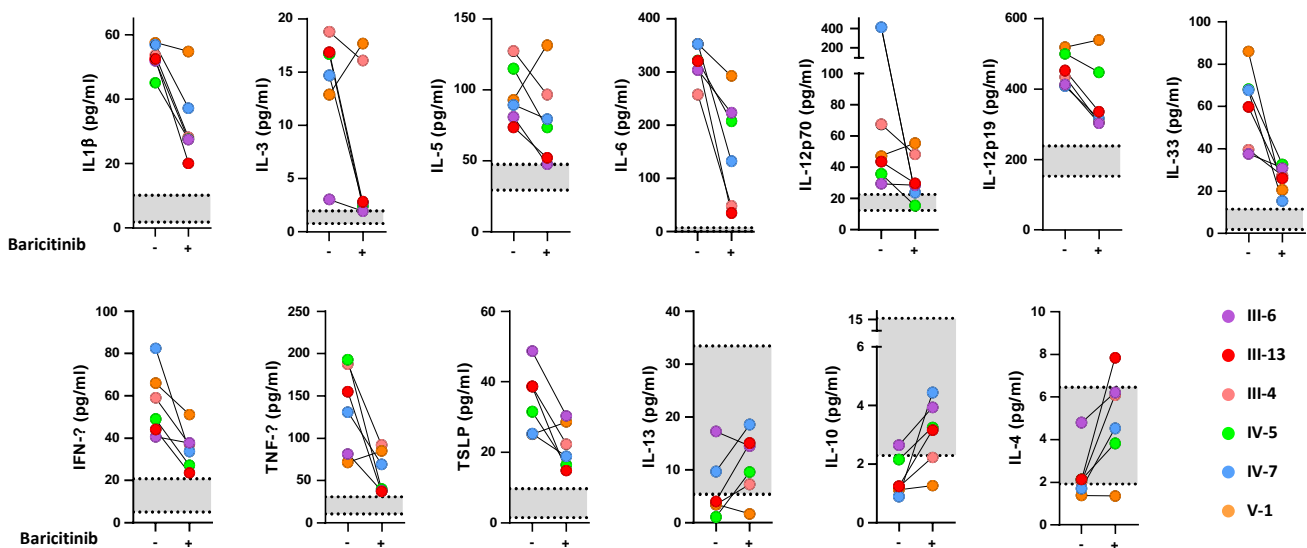
A



B



C



## Supplementary Appendix:

### Successful treatment of *JAK1* associated inflammatory disease

Antoine Fayand<sup>1,21</sup>, Véronique Hentgen<sup>2\*</sup>, Céline Posseme<sup>3\*</sup>, Carole Lacout<sup>4,21\*</sup>, Capucine Picard<sup>5</sup>, Philippe Moguelet<sup>6</sup>, Margaux Cescato<sup>1</sup>, Nabiha Sbeih<sup>7</sup>, Thomas R.J. Moreau<sup>1</sup>, Yixiang YJ Zhu<sup>1</sup>, Jean-Luc Charuel<sup>8</sup>, Aurélien Corneau<sup>9</sup>, Joelle Deibener-Kaminsky<sup>10</sup>, Stéphanie Dupuy<sup>11</sup>, Mathieu Fusaro<sup>5</sup>, Benedicte Hoareau<sup>8</sup>, Alain Hovnanian<sup>12,13</sup>, Vincent Langlois<sup>14</sup>, Laurent Le Corre<sup>15</sup>, Thiago Trovati Maciel<sup>7</sup>, Snaigune Miskinyte<sup>12</sup>, Makoto Miyara<sup>8,16</sup>, Thomas Moulinet<sup>10</sup>, Magali Perret<sup>17</sup>, Marie Hélène Schuhmacher<sup>18</sup>, Rachel Rignault-Bricard<sup>7</sup>, Sébastien Viel<sup>13</sup>, Angélique Vinit<sup>9</sup>, Angèle Soria<sup>19</sup>, Darragh Duffy<sup>3</sup>, Jean-Marie Launay<sup>20</sup>, Jacques Callebert<sup>20</sup>, Jean Philippe Herbeuval<sup>1</sup>, Mathieu P Rodero<sup>1§</sup>, Sophie Georgin-Lavialle<sup>21§†</sup>.

<sup>1</sup> Université Paris Cité, CNRS, Laboratoire de Chimie et de Biochimie Pharmacologiques et Toxicologiques, F-75006 Paris, France. <sup>2</sup> Pediatric Infectious Disease Group (GPIP), Créteil, France; Department General Pediatrics, Centre Hospitalier de Versailles, Le Chesnay, France. <sup>3</sup> Translational Immunology Unit, Institut Pasteur, Université de Paris Cité, Paris, France. <sup>4</sup> Sorbonne University, Genetic Laboratory, Assistance Publique - Hôpitaux de Paris (APHP), Trousseau Hospital, Paris, France. <sup>5</sup> Study Center for Primary Immunodeficiencies, APHP, Necker Hospital for Sick Children, Université de Paris Cité, Paris, France. <sup>6</sup> Department of Pathology, Sorbonne University, Tenon Hospital, APHP, Paris, France. <sup>7</sup> Laboratory of Cellular and Molecular Mechanisms of Hematological Disorders and Therapeutical Implications, Université Paris Cité, Imagine Institute, Inserm U1163, Paris, France. <sup>8</sup> Groupement Hospitalier Pitié-Salpêtrière APHP, Département of immunology, Paris, France. <sup>9</sup> Sorbonne Université, UMS037, PASS, Plateforme de Cytométrie de la Pitié-Salpêtrière CyPS, Paris, France. <sup>10</sup> Department of Internal Medicine and Clinical Immunology, Nancy University Hospital, 5 Rue du Morvan, Vandoeuvre-lès-Nancy 54500, France; UMR 7365, IMoPA, University of Lorraine, CNRS, Nancy, France. <sup>11</sup> BioMedTech Facilities INSERM US36 - CNRS UAR2009 - Université Paris Cité, France. <sup>12</sup> INSERM UMR1163, Laboratory of genetic skin diseases, Imagine Institute, University Paris Cité, Paris, France. <sup>13</sup> Department of Genomics Medicine of Rare Diseases, Hôpital Necker Enfants Malades, AP-HP, Paris, France. <sup>14</sup> Department of Internal Medicine, Jacques Monod Hospital, Le Havre, France. <sup>15</sup> Université de Paris Cité, CNRS, UMR8601, LCBPT, Macromolecular Modeling Platform, Paris, France. <sup>16</sup> Inserm U1135, Centre d'Immunologie et des Maladies Infectieuses (CIMI-Paris), Hôpital Pitié-Salpêtrière, AP-HP, Sorbonne Université, Paris, France. <sup>17</sup> Immunology Laboratory, Lyon Sud Hospital, Hospices Civils de Lyon, University of Claude Bernard-Lyon 1, Lyon, France. <sup>18</sup> Department of Internal Medicine, Emile Durkheim Hospital, Épinal, France. <sup>19</sup> Tenon Hospital, Dermatology-Allergology Department, Sorbonne University, Paris, France. <sup>20</sup> Service of Biochemistry and Molecular Biology, INSERM U942, Hospital Lariboisière, APHP, Paris, France. <sup>21</sup> Sorbonne Université, APHP, Tenon Hospital, department of internal medicine, Paris, France.

\* Contributed equally

§ Codirected the study

† Corresponding author: Sophie Georgin-Lavialle : Sorbonne Université, APHP, Tenon hospital, Department of Internal Medicine, National reference center for autoinflammatory diseases and inflammatory amyloidosis (CEREMAIA), Paris, France.

[sophie.georgin-lavialle@aphp.fr](mailto:sophie.georgin-lavialle@aphp.fr)

# CONTENTS

## I. Supplementary Methods

## II. Supplementary Figures

Figure S1: Clinical findings

Figure S2 Pathological findings

Figure S3: Clinical immunophenotyping of patients

Figure S4: Modelling

Figure S5: Type 1 interferon signature

Figure S6: Basal pSTAT1, pSTAT3, pSTAT5b and pSTAT6 levels in blood leukocytes from IV-7 and healthy donors

Figure S7: STAT3 phosphorylation in NK cells from patient IV-7 and healthy donors whole blood in response to stimulation with interleukin 2

Figure S8:

Figure S9 Clinical response to JAK inhibitors

Figure S10: Correction of Cytokine circulating levels by baricitinib in patients

Figure S11: Transcriptomic signature of patients after initiation of JAK inhibitor treatments

Figure S12: STAT1, STAT3, STAT5b and STAT6 phosphorylation in patients and healthy donors PBMCs following various cytokine stimulations and in vitro treatment with baricitinib

Figure S13: Sustained basophilia under JAK inhibitor treatments

Figure S14: Control of canonical STAT phosphorylation by JAK inhibitors

Figure S15: Response to treatment

Figure S16: Cytokine profile in patients successively treated with baricitinib and upadacitinib.

Figure S17: Phenotypic overlap of JAK1<sup>C787F</sup> with other JAK1 GOF variants

Figure S18: Gating strategy for cell sorting

## III. Supplementary Tables

Table S1: Clinical findings

Table S2: Auto immunity screening

Table S3: Treatment information for samples with cytokines dosages

Table S4: List of fluorochrome-conjugated antibodies used for membrane antigen staining

Table S5: List of metal-isotope-tagged antibodies used for mass cytometry

# **I. Supplementary Methods**

## **Patients and study approval**

All adult family members were under care of the same clinician (SGL) and the children of the same paediatrician (VH). As part of their routine care, patients underwent a series of complete physical examinations and underwent several biological, radiological and pathological studies. Cutaneous, articular and digestive disease activities during follow-up were assessed by the treating physician using a subjective scale ranging from 0 (no activity) to 5 (severe involvement). Additionally, all patients, or parents for children, and healthy relatives provided written informed consent for participation, genetic testing and blood samples in accordance with the Declaration of Helsinki and after approval from the ethics committee. An external institutional review board approved the study protocol (CPP Sud Est V, EudraCT number 2018-A01358-47/1).

## **Collection of blood samples**

Blood samples from patients and healthy donors were collected using heparin-coated tubes and with PAXgene Blood RNA tubes (Ozyme). Blood from healthy donors were provided by the “Établissement Français du Sang” (EFS) (convention N°13/CABANEL/089 between “CNRS” and EFS). An informed consent was obtained from all subjects. Serum samples were obtained by centrifugation at 450 x g for 10 min and stored at -80°C. Peripheral blood mononuclear cells (PBMCs) were isolated from fresh whole blood using Ficoll gradient (centrifugation 800 x g for 20 min) and stored in an FCS with 10% DMSO solution at -150°C. PAXgene Blood RNA tubes were stored at -20°C.

## **DNA extraction and library preparation**

DNA was extracted from EDTA-treated peripheral blood samples, either manually by the phenol-chloroform method, or with a Chemagic Prime instrument (Perkin Elmer). Genomic DNA libraries were generated from 2 µg of DNA sheared with a Covaris S2 Ultrasonicator, with the SureSelectXT Library PrepKit [Agilent, Garches, France], on the Genomic Platform at the Imagine Institute, Paris. Capture was performed by hybridization, with 120 bp biotinylated complementary RNA baits designed with SureSelect SureDesign software (Agilent, H. sapiens, hg19, GRCh37, February 2009) that cover approximately 1.095 Mbp encompassing 4136 regions of interest (ROIs) comprising all exons and splicing junctions of the 300 genes selected for study (Table S1). The targeted ROIs were pulled out with magnetic streptavidin beads, amplified by PCR with indexing primers and sequenced on an Illumina HiSeq2500 HT system (paired-end sequencing, 2 x130 bases).

## **Bioinformatic analysis**



Data were analyzed at the Paris University/Imagine Institute's Bioinformatics core facilities. Paired-end sequences were mapped onto the human reference genome (NCBI build37/hg19 version) with the Burrows-Wheeler Aligner. Downstream processing was performed with the Genome Analysis Toolkit (GATK), SAMtools and Picard, according to documented best practices (<https://software.broadinstitute.org/gatk/best-practices/>). Variant calls were made with the GATK Unified Genotyper, based on the 72nd version of the ENSEMBL database. Genome variants were defined with our in-house PolyDiag software for NGS, which filters out irrelevant and common polymorphisms on the basis of frequencies in public databases: the US National Center for Biotechnology Information Database of Single Nucleotide Polymorphisms (SNPs) (dbSNP), 1000 Genomes, Exome Variant Server (EVS, <http://evs.gs.washington.edu/EVS/>), and Genome Aggregation Database (GnomAD, <https://gnomad.broadinstitute.org/>).

### **NGS and Sanger sequencing**

We performed a Next Generation Sequencing (NGS) panel targeting 300 genes causal of PID (23) and 450 genes related to skin diseases. This strategy led to the identification of a heterozygous missense mutation in the exon 19 of *JAK1* gene (NM\_002227.4): c.2360 G>T; p.(Cys787Phe). This mutation has never been reported in the GnomAD, dbSNP and HGMD databases. This *JAK1* mutation was confirmed by Sanger sequencing for the index case and several members of his kindred. Primers sequences are available upon request.

### **Histology**

Formalin-fixed, paraffin-embedded tissues were studied. Three-micrometer-thick sections were stained with hematoxylin–eosin–safran (HES). Immunohistochemical staining was performed, using anti-JAK1 antibody (rabbit polyclonal antibody, each vial containing 100 µg IgG at 1mg/ml, Abcam ab47435) and anti-STAT3 (rabbit monoclonal antibody, each vial containing 100 µg IgG at 1.046 mg/ml Abcam ab76315) at dilution of 1/100 ; anti-CD8, CD31, CD34, CD68, CD99, CD117, AE1/AE3, calretinin, b-catenin, bcl-2, EMA, IgG4, IgG, PS100 (Dako france), STAT6 (Abcam). Deparaffinized sections were stained using a standard avidin–biotin–peroxidase method with diaminobenzidine (DAB) chromogen, and the BOND-III Autostainer (Leica Microsystems, Newcastle-upon, Tyne, UK), after antigen retrieval by heating in the appropriate buffer (pH 6.1 for JAK1 or 9.0 for STAT3, 97°C, for 10 minutes). All skin biopsies were examined and interpreted by the same pathologist (PM).

### **Cytokine measurements**

The biomarker analyses were blinded. Plasma concentrations of IL-1β, IL-3, IL-4, IL-5, IL-6, IL-10, IL-12p70, IL12-p19, IL-13, IL-33, TNF-α, IFN-γ and TSLP were measured using sandwich

immunoassay methods with commercially available electrochemiluminescent detection systems, plates and reagents (V-PLEX human cytokine 30-Plex kits (Meso-Scale Discovery (MSD), Gaithersburg, USA), as per the manufacturer's instructions. Briefly, 50  $\mu$ L of plasma was loaded per well in the MSD plates. The plates were analyzed using the SECTOR Imager 2400.

### **Histamine**

Blood samples were collected in heparin-coated tubes. After cell lysis by adding 50  $\mu$ L of blood to 950  $\mu$ L of distilled water, freezing and thawing twice, and centrifugation at  $10,000 \times g$  for 10min at  $4^{\circ}\text{C}$ , the supernatant was collected for radioimmunoassay (RIA histamine kit, ref. IM1659, Beckman Coulter). Briefly, histamine in samples, calibrators and controls is chemically modified by acylation. Thereafter acylated histamine is incubated in monoclonal antibody coated tubes in presence of  $^{125}\text{I}$ -labeled acylated histamine tracer. Following incubation, the contents of the tubes are aspirated and bound radioactivity is measured in a gamma counter. A calibration curve is established and unknown values are extrapolated from the standard curve.

### **Cytokine stimulation and treatment of PBMC/whole blood**

PBMCs or whole blood cells were incubated at  $37^{\circ}\text{C}$  with IFN- $\alpha$ 2 (100 UI/mL), IL-2 (50 ng/mL), IL-4 (50 ng/mL), IL-6 (10 ng/mL) or IFN- $\gamma$  (400 UI/mL) for 30 min. Cellular response was then assessed using fluorescence activated cell sorting (FACS) or mass cytometry (CyTOF) (see below). For treated conditions, cells were incubated at  $37^{\circ}\text{C}$  with baricitinib (200 nM) for 15 min prior to cytokine stimulation.

### **Flow cytometry**

#### *For the study of STATs phosphorylation*

The phosphorylation of STAT1, STAT3, STAT5B and STAT6 were assessed in PBMCs (1 million cells per condition) from patients and healthy donors at basal state and after cytokine stimulation with or without baricitinib. We used the PerFix EXPOSE kit (Phospho-Epitopes Exposure kit, Beckman Coulter) according to the manufacturer's instructions except for the staining of membrane antigens, which was carried out before cell fixation. Membrane antigen staining was achieved using two different mixes of fluorochrome-conjugated antibodies (Table S4). Mix 1 was used for experiments with IFN- $\alpha$ 2 and IL-2 stimulations, whereas mix 2 was used for experiments with IL-4 and IL-6 stimulations.

Cells were then fixed and permeabilized. Finally, staining of intracellular STATs was performed using anti-pSTAT1-AF488 (clone 4a, BD Biosciences), anti-pSTAT3-VB500 (clone REA324, Miltenyi Biotec), anti-pSTAT5b-PE (clone SRBCZX, Life technologies) and anti-pSTAT6-PE (clone REA413, Miltenyi Biotec). After washing, samples were acquired on a Attune NxT cytometer (ThermoFisher). FACS data were analysed with Kaluza software (Beckman Coulter). The following gates were applied before the identification of specific cell types: FSC-A / SSC-A and FSC-H / FSC-A for exclusion of doublets. We defined the following specific cell types: classical monocytes (CD14<sup>+</sup> CD16<sup>-</sup>), inflammatory monocytes (CD14<sup>dim</sup> CD16<sup>+</sup>), naive B-cells (CD19<sup>+</sup> IgD<sup>+</sup>), memory B-cells (CD19<sup>+</sup> IgD<sup>-</sup>), CD4 T-cells (CD3<sup>+</sup> CD8<sup>-</sup> with mix 1; CD3<sup>+</sup> CD4<sup>+</sup> with mix 2), CD8 T-cells (CD3<sup>+</sup> CD8<sup>+</sup>), immature NK-cells (CD56<sup>bright</sup> CD16<sup>-</sup>) and mature NK-cells (CD56<sup>dim</sup> CD16<sup>+</sup>). Mean fluorescent intensity (MFI) of each pSTAT specific antibody-fluorochrome was then assessed in each cell type. The effect of cytokine stimulation with or without baricitinib on phosphorylation of STATs is given as fold-increase of MFI pSTAT<sub>x</sub> after stimulation over unstimulated level.

#### *For measure of activation markers on basophils*

Peripheral blood basophils from patients and controls were stained and analyzed by conventional flow cytometry in a Gallios (Beckman-Coulter) cytometer using FlowJo software. The following labeled human antibodies were used: eF506 anti-CD45 (clone HI30, eBioscience), eF450 anti-FcεRIα (clone AER-37, eBioscience), PE anti-CD123 (clone 6H6, eBioscience), APC-Cy7 anti-CCR3 (clone 5E8, BioLegend®), APC anti-CD203c (clone NP4D6, eBioscience), PE-Dazzle594 CD107a (clone H4A3, BioLegend®), PE-Cy7 CD69 (clone FN50, BioLegend®), PerCP-Cy5.5 CKit (clone A3C6E2, BioLegend®), and FITC anti-CD63 (clone H5C6, BioLegend®). Basophils were defined as FcεRI CD123 CCR3 positive cells and CKit negative cells.

#### **Mass cytometry**

In addition to phosphoflow, CyTOF was performed to assess the phosphorylations of STAT1, STAT3, STAT4, STAT5b and STAT6 as well as NFκB in whole blood (300 μL per condition) of patients and healthy donors at basal state and after cytokines stimulation. First experiments were performed using the PerFix EXPOSE kit (Phospho-Epitopes Exposure kit, Beckman Coulter) with the same amendment to the manufacturer's protocol: 1- labelling of membrane antigen with metal-isotope-tagged antibodies (Table S5), 2- fixation, 3- permeabilization and 4- labelling of intracellular antigens (Table S5). In a second set of experiments the phosphorylations of STAT1, STAT3, STAT5b and STAT6 were evaluated as follow: 1-labelling of membrane antigen with metal-isotope-tagged antibodies (Table S4, but

instead of CD38-144Nd, CD38-172Yb 5HIT2 clone was used – Fluidigm), 2-fixation using Protein Stabilizer Prot1 (SmartTube Inc.), 3-permeabilisation using a thaw-lyse buffer (SmartTube Inc.) and pure methanol, 4-labelling of intracellular antigens (Table S4). For both experiments, after washing of tagged antibodies targeting intracellular antigens, samples were resuspended in PBS with 2% formaldehyde (Thermo scientific) and 125 nM of Cell-ID™ Intercalator-Ir (Fluidigm) and incubated at 4°C overnight. Samples were then stored at -80°C. Cells were washed twice in PBS+0.5% SVF and then washed and resuspended in Maxpar cell acquisition solution, a high ionic strength solution, at a concentration of 1 million cells per ml and mixed with 10% EQ beads (for sample standardisation) just prior to acquisition.

Cell events were acquired on the Helios mass cytometer (DVS sciences) and CyTOF software version 6.7.1014 (Fluidigm, Inc Canada) at the "Plateforme de Cytométrie de la Pitié-Salpêtrière (CyPS)". An average of 250,000 events were acquired per sample. The standard mass cytometry files (fcs3.0) produced by HELIOS were normalised using the CyTOF software. This method normalises the data to a global standard determined for each log of EQ beads. CyTOF data were analysed with OMIQ (Omiq, Inc.). The analysis was conducted on CD25+ and CD25low viable cells only. Each of the three patients and the three healthy donors were analysed individually, as well as the 3 healthy donors concatenated. Blood leukocyte populations and sub-populations were identified using unsupervised clusterisation with the FlowSOM algorithm. A first FlowSOM run (xdim=12, ydim=12, rien=10, distance metric=euclidean, random seed=6025) allowed us to identify clusters corresponding to granulocytes, which were subsequently excluded from subsequent analysis. A second FlowSOM run (xdim=10, ydim=10, rien=10, distance metric=euclidean, random seed=506) was used to generate a new set of clusters organised in a spanning tree. According to their phenotypes, clusters were manually distributed in metaclusters corresponding to leukocyte populations and sub-populations. As a quality control we performed dimensionality reduction using t-SNE (perplexity: 60; Theta: 0.8, Random Seed: 3173; Max iteration: 2000; all other: default settings) to manually gate on CD56+ NK cells. For each patient, donor or group of donors, the effect of cytokine stimulations in each cluster or gate, expressed as fold-increase of phosphoprotein signal, was displayed on the spanning tree or as histogram plots.

### **Multiplexed gene expression analysis**

Starting from PAXgene Blood RNA tubes (Ozyme), RNA of healthy donors and patients (before and after treatment with baricitinib) was extracted using Quick-RNA Whole Blood kit (Zymo Research). Samples were stored at -20°C. After thawing, quantity of RNA was measured with the Qubit RNA High Sensitivity kit (Life Technologies). A total of 100 ng RNA per sample was used to assess the expression of 750 genes involved in immunity with the nCounter Human Autoimmune Profiling Panel (Nanostring). Expression data were normalized using the nSolver software (Nanostring) in 3 steps: 1-

subtraction of geometric mean of negative probes, 2- normalization of data using geometric mean of positive probes and 3- normalization of data using housekeeping genes selected with the geNorm algorithm. Differential gene expression analysis was conducted in R (R Core Team, 2020) with “broom” package, using multiple linear regression. Gene set enrichment analysis was conducted in GSEA (version 4.1.0, Broad Institute) using pathway annotations from Biocarta database and the following parameters: number of permutations= 2000, enrichment statistic = classic, min set size = 5, max set size = 200 and all others set to default. Figures were produced using Prism software, version 9.1.1 (version 9.1.1, GraphPad).

### **ISG score:**

200ng of RNA were hybridized to the probes (a reporter probe and a capture probe) at 67°C for 16–21h using a thermocycler. Samples were then inserted into the nCounter Prep Station for the removal of excessive probes, purification and immobilization onto the internal surface of a sample cartridge for 2–3h. Finally, the sample cartridge was transferred to the nCounter Digital Analyzer where color codes were counted and tabulated for each target molecule. Count number obtained for the 6 ISGs were normalized by the geometric mean of 3 housekeeping genes count number ( $\beta$ -Actin, HPRT1 and POLR2A) as well as the negative and positive controls values using nSolver software. The relative expression was determined for each normalized ISG expression dividing by the median normalized expression of each ISG from a control group. Finally, the median relative expression of these 6 ISGs was used to calculate the IFN score.

### **RNA sequencing**

Fastq files were then aligned using STAR algorithm (version 2.7.6a), on the Ensembl Homo sapiens GRCh38 reference, release 101.

Reads were then count using RSEM (v1.3.1) and the statistical analyses on the read counts were performed with R (version 3.6.3) and the DESeq2 package (DESeq2\_1.26.0) to determine the proportion of differentially expressed genes between two conditions.

We used the standard DESeq2 normalization method (DESeq2’s median of ratios with the DESeq function), with a pre-filter of reads and genes (reads uniquely mapped on the genome, or up to 10 different loci with a count adjustment, and genes with at least 10 reads in at least 3 different samples). Following the package recommendations, we used the Wald test with the contrast function and the Benjamini-Hochberg FDR control procedure to identify the differentially expressed genes.

R scripts and parameters are availables on GitHub (<https://github.com/BSGenomique/genomic-rnaseq-pipeline/releases/tag/v1.0420>)

### **Cell sorting**

Peripheral blood mononuclear cells (PBMCs) and polynuclear cells (PN) were isolated from blood using Percoll (GE Healthcare) density gradient. Briefly, 100% isotonic Percoll was made by 1/10 dilution of 10X PBS in Percoll. 85%, 80%, 75%, 70% and 65% isotonic Percoll solutions were made by dilution in PBS and 2ml of each solution were layered from the higher to the lower density in Falcon-15 tubes. Whole blood from patients or healthy donors was spun for 10 minutes at 450 x g. Buffy coat was collected at the interface between red blood cells and plasma. 5ml of buffy coat was layered on top of the Percoll gradient. Tubes were centrifuged for 20 minutes at 800 x g with no brake.

The cell layer at the interface between the 65% Percoll solution and PBS (PBMC enriched fraction) and cells at the interface between the 65% and 70%, the 70% and 75%, and the 75% and 80% fraction (PN enriched fraction) were collected and washed in PBS. Remaining red blood cells from the PN enriched fraction were lysed by 10 second incubation in 9ml of water followed by addition of 1ml of 10X PBS.

PBMCs enriched cells were labelled with CD3 APC (Miltenyi, REA613), CD19 PE-Cy7 (Invitrogen, SJ25C1), CD56 PE (Biolegend, 5.1H11) and CD14 APC AF750 (Beckman Coulter, RMO52). PN enriched cells were labelled with CD16 APC (Miltenyi, REA423), CD123 FITC (Miltenyi, REA918) and HLADR PcP-Cy5 (Biolegend, L243). PBMC and PN subsets were isolated using a BD FACS Aria II according to the gating strategy defined in Fig. S17. After sorting, cells were pelleted, and stored at -80 °C until analysed for histamine content.

### **Protein modelling: PDB reference**

The Impact of the C787F mutation on protein stability was evaluated using the calculated mutation energy protocol implemented in Discovery Studio (DS) 2016 (24). The negative value of the mutation energy (-0.75 kcal.mol<sup>-1</sup>) calculated for C787F mutant corresponds to a stabilizing effect. Furthermore, a model structure of mutated C787F human JAK1 was built using the Built Mutants protocol incorporated in DS 2016 (25). In this model, the mutated C787F residue formed new interactions with C817 and Y788.

### **Autoimmunity Panel**

Indirect Immunofluorescence on HEp-2000™ cells and rat tissues.

Serum samples from all participants were subjected to the ANA-test and anti-rat kidney, stomach and liver tissue test using commercial slides (Immunoconcept ) and a PhD system

immunoassay (Biorad). HEp-2000™ are HEp-2 cells with overexpressed Ro60 antigens. Serum samples were diluted in PBS buffer and incubated for 25 minutes at room temperature in a moist chamber. After washing twice in PBS, cells were incubated with fluorescein isothiocyanate conjugated goat anti-human IgG, Ig heavy and light chains, Immunoconcept for ANA-test and anti-human polyvalent immunoglobulins, Biorad for anti-rat tissue for another 25 minutes in the dark. After washing twice as before, slides were counter-stained with Evans blue and assembled with glycerol and coverslips.

### **Statistics**

All statistical analyses were performed using GraphPad Prism (version 9.1.1). As indicated in the Figures, results were analyzed in a two-tailed, unpaired or paired Student's *t* test, or a two-sided Mann–Whitney U test. For all analyses, the threshold for statistical significance was set to  $p < 0.05$ .

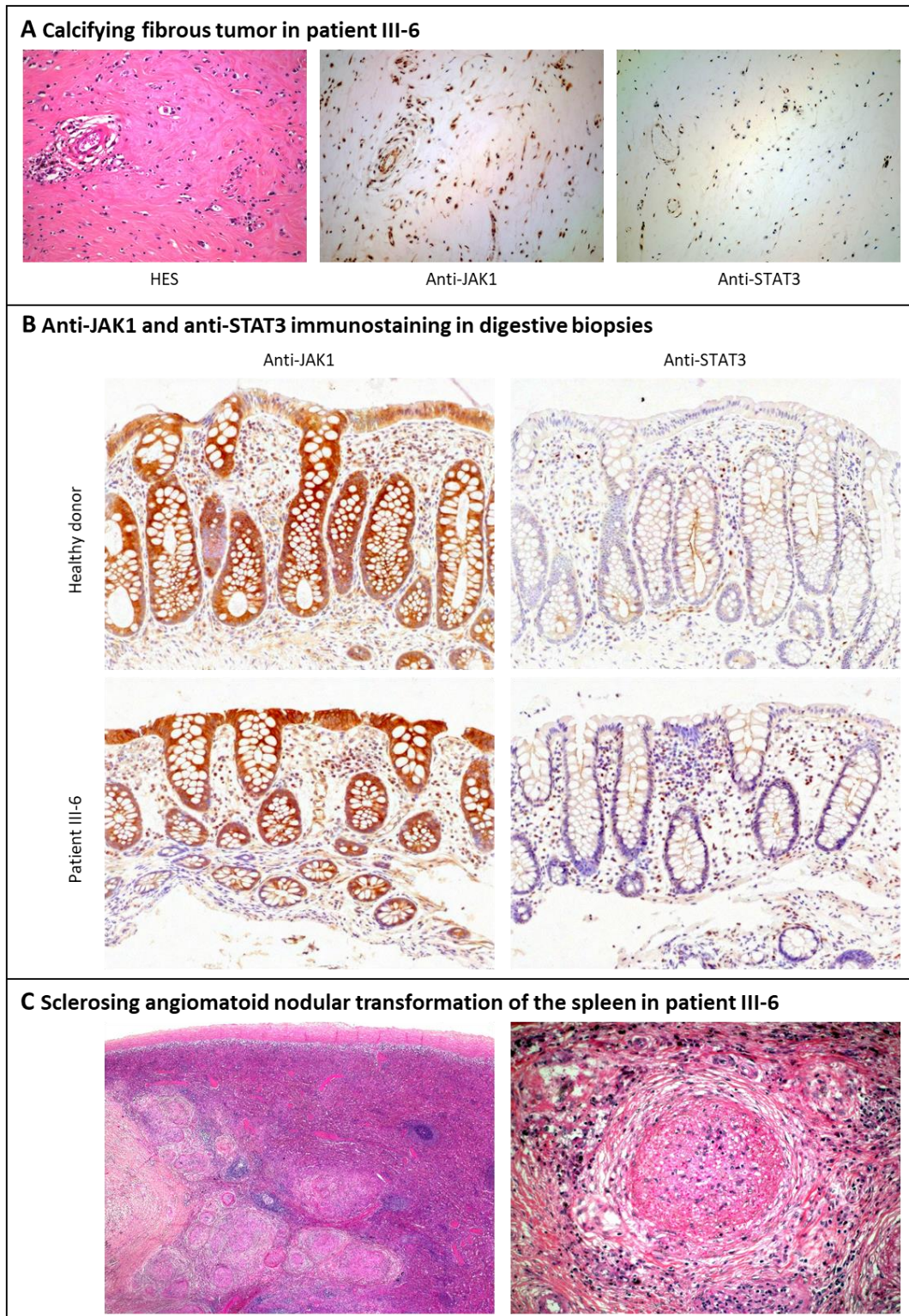
## Sup Figure 1



### **Figure S1**

Clinical aspects of several family members. A: Face involvement of atopic dermatitis in, from left to right, patients V-4, IV-9, IV-5 and II-16. B: Details of the eyelid dermatitis with Dennie-Morgan fold in, from left to right, patients V-4, IV-9, IV-5, and II-16. C: Hands of patients IV-9 (left) and III-13 (right) with ichthyosis, , lichenification and wart sequela. D: Ichthyosis and lichenification involvement of feet from several patients (left to right: V-1, IV-9, III-4, II-16). E: From left to right: atopic dermatitis of the wrist of patient V-1, atopic dermatitis inside the bend of the elbow of patient V-5, and inflammatory linear verrucous epidermal papules of the forearms of patients IV-5 and III-4.

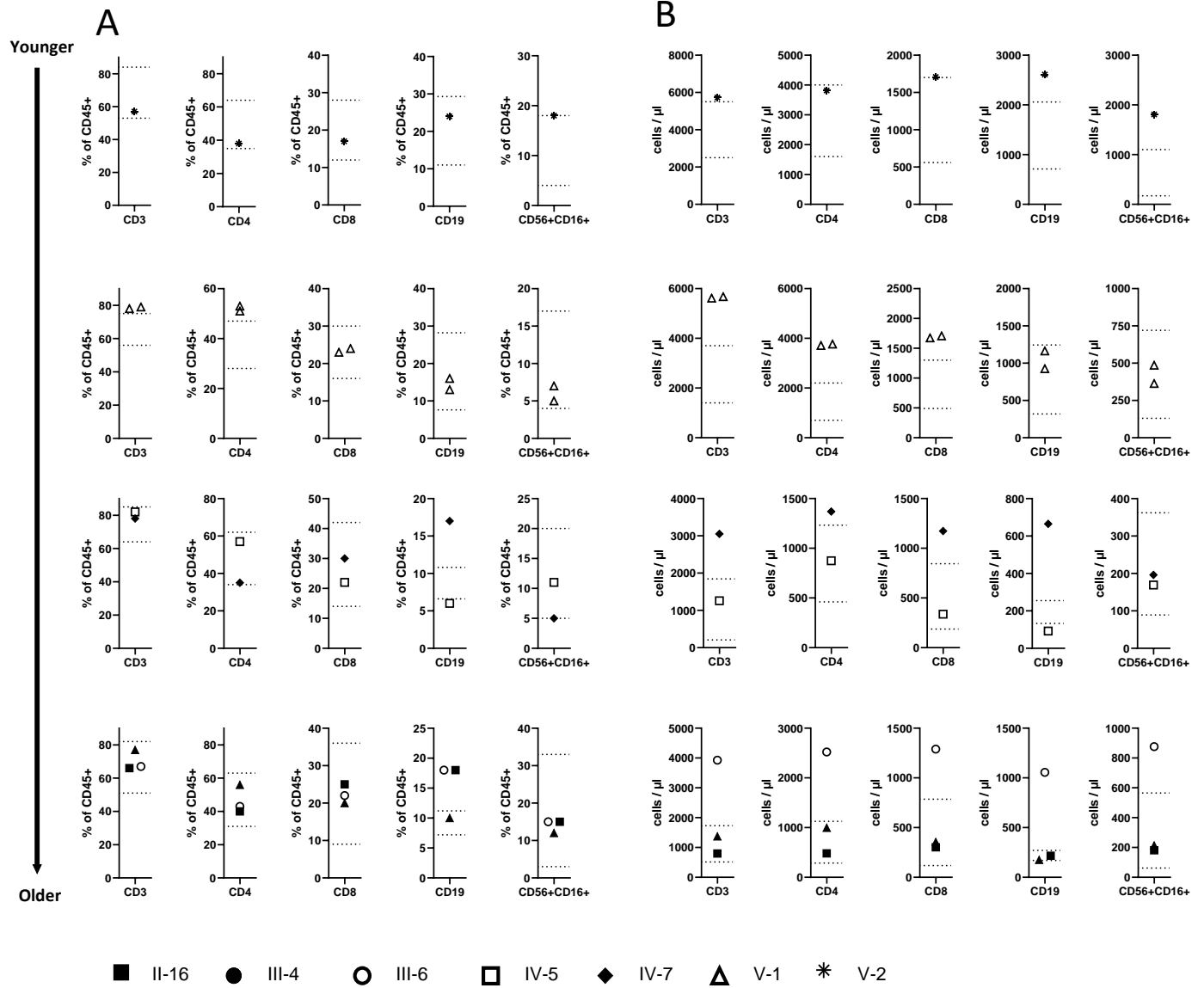




**Figure S2 Pathological findings**

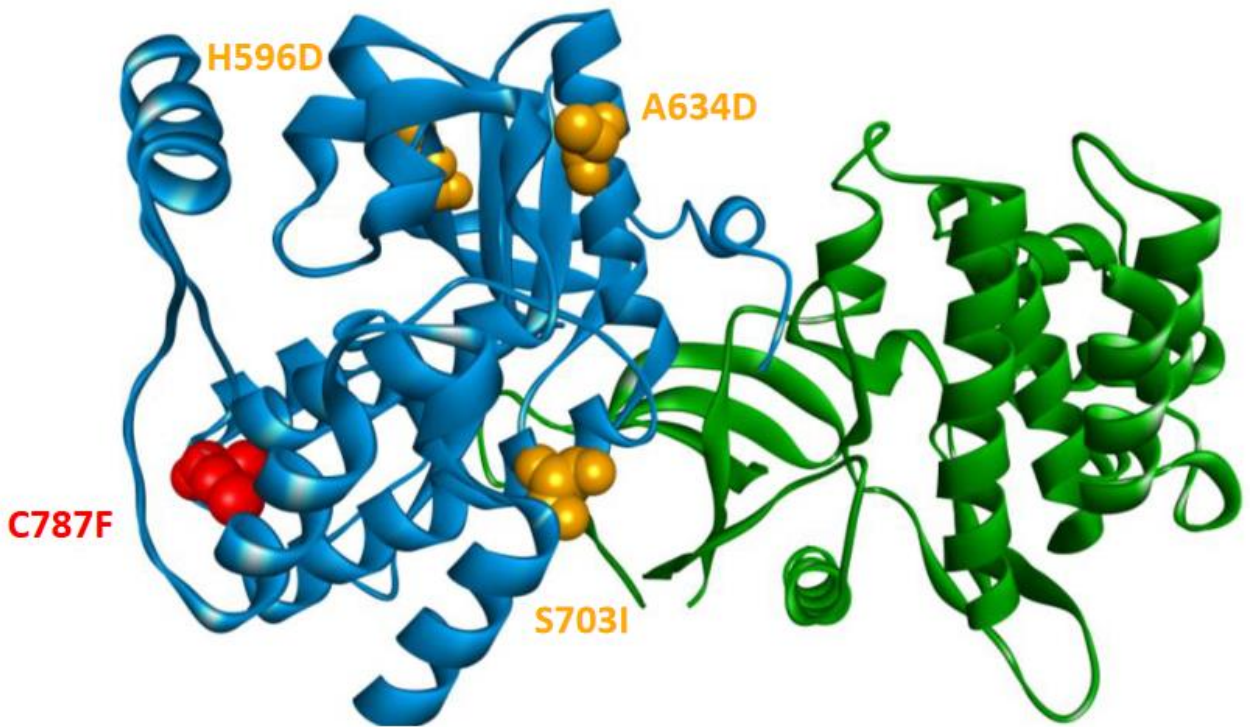
**A)** Pathological characteristics of calcifying fibrous tumours including, from left to right, HES x200: fibrosis with fibroblastic proliferation and inflammatory infiltrate; JAK1 staining x200: high cytoplasmic JAK1 expression in endothelial and fibroblast cells; STAT3 staining x200: high nuclear STAT3 expression in endothelial and fibroblast cells. **B)** Anti-JAK1 and anti-STAT3 immunostaining of digestive biopsies from healthy donors and patient III-6, showing no difference. **C)** Pathological characteristics of the sclerosing angiomatoid nodular transformation of the spleen (SANT) in patient III-6 with, from left to right, HES x20: multinodular mass in the red pulp and HES x200: single angiomatoid nodule with central vascular spaces lined by plump endothelial cells, surrounded by a ring of fibrosis.

# Sup Fig 3



**Figure S3: Clinical immunophenotyping of patients.** Representation of **A)** the proportion and **B)** the number of the main leukocyte population in patients. Dot lines represent distribution ranges in age-paired healthy individuals.

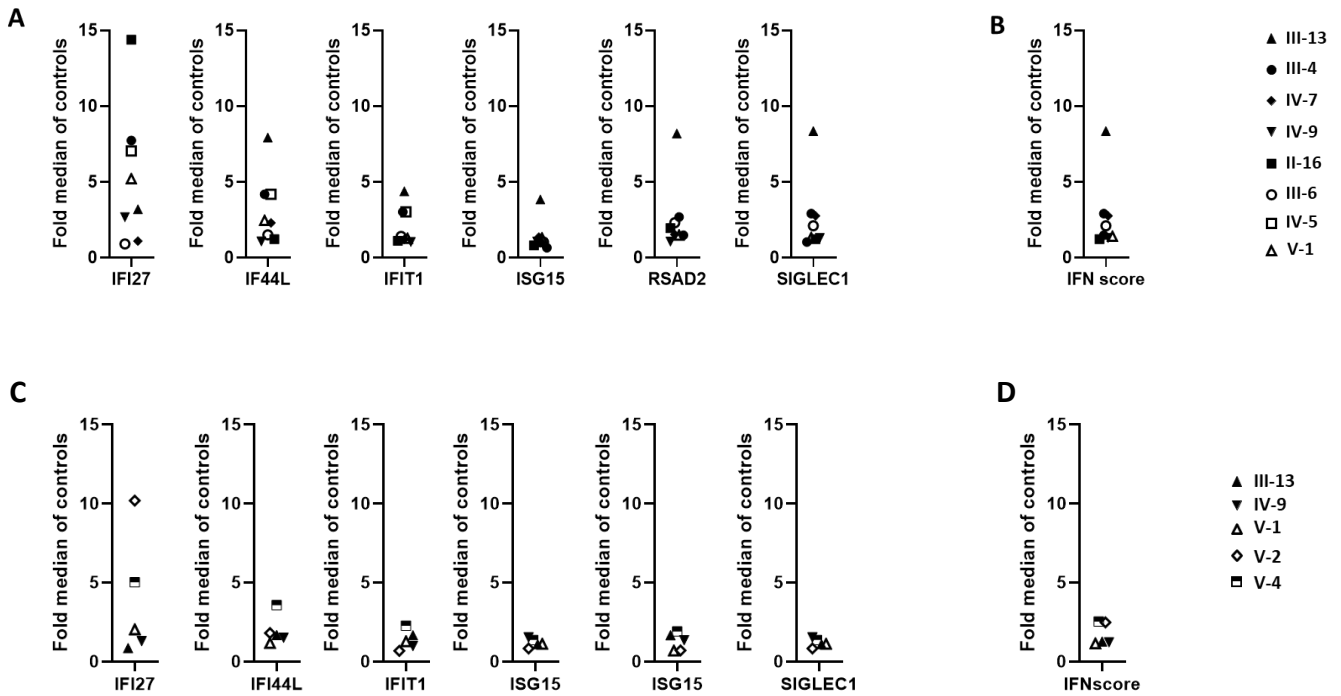
Sup Fig 4



**Figure S4 : Modeling of kinase and pseudokinase domains of JAK1.**

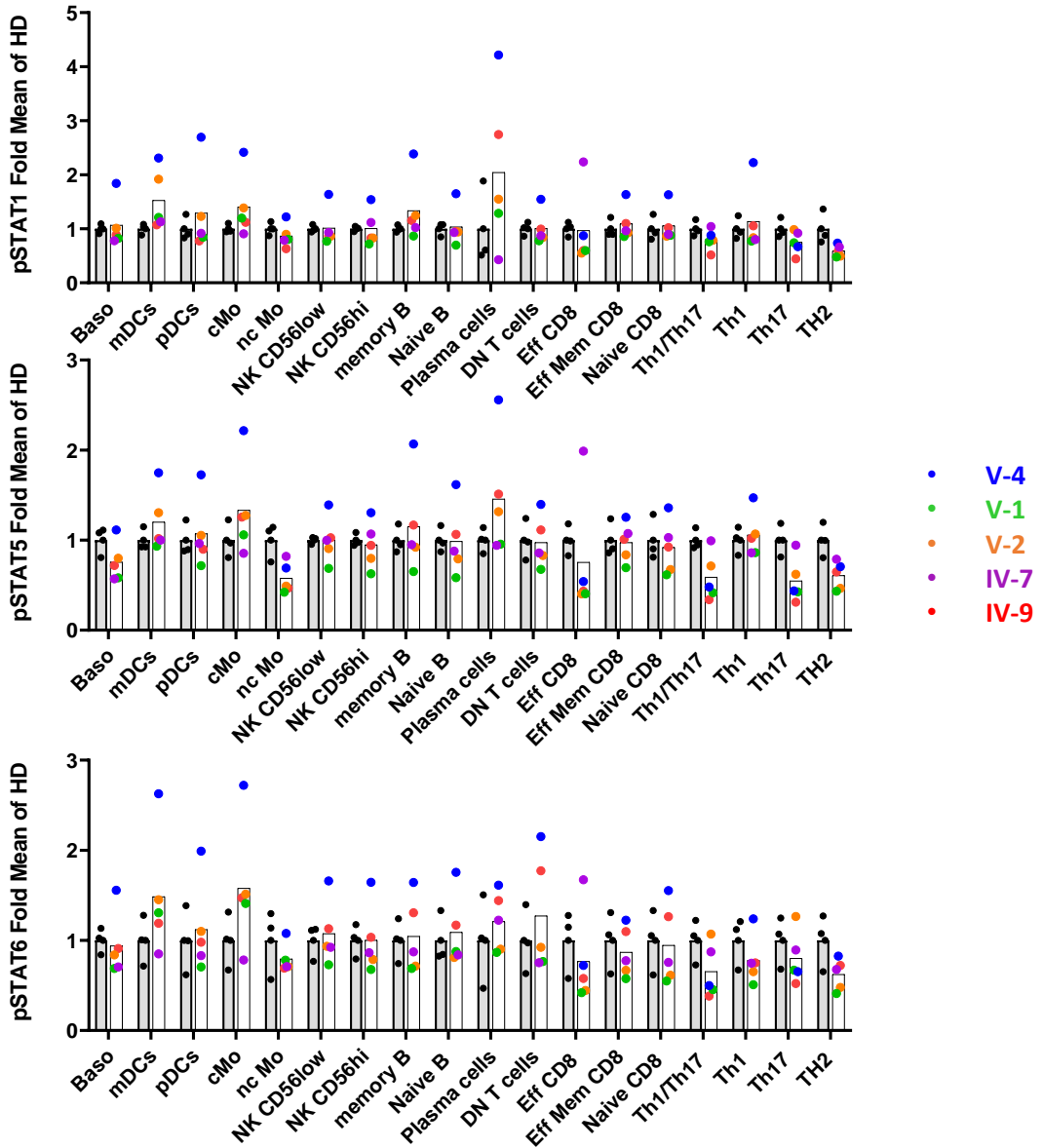
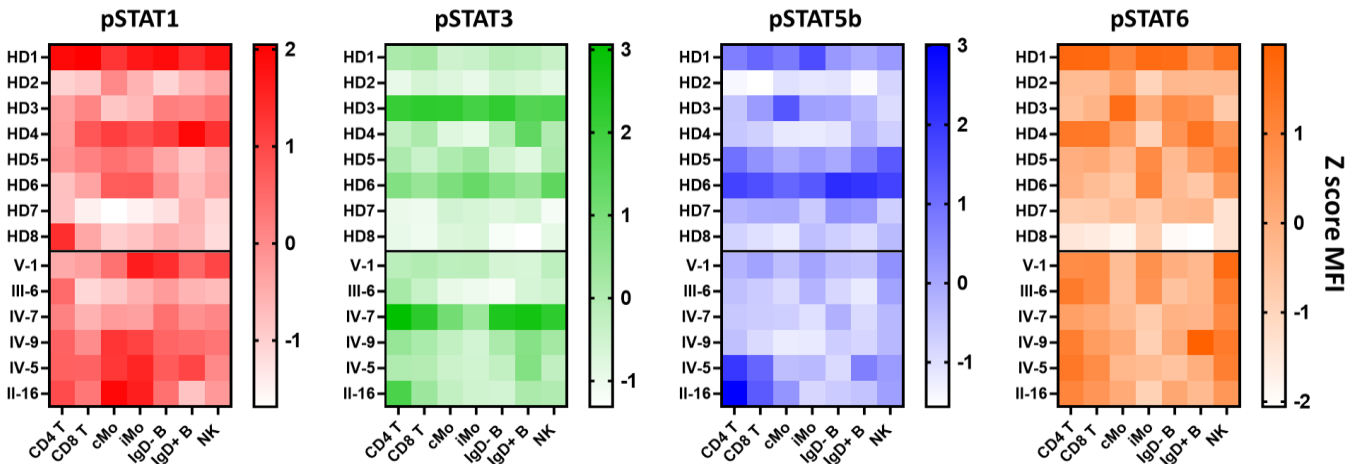
3D modelling of JAK1 pseudo Kinase domaine (**Blue**) and Kinase domain (**Green**) with previously describe mutation in orange, and the novel mutation in red.

## Sup Fig 5

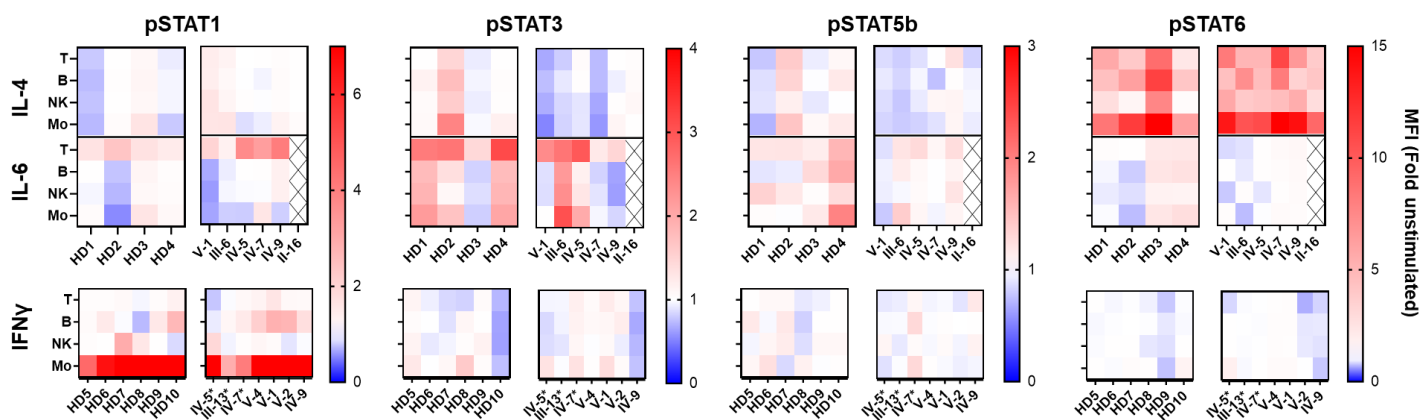


### Figure S5: Type 1 interferon signature

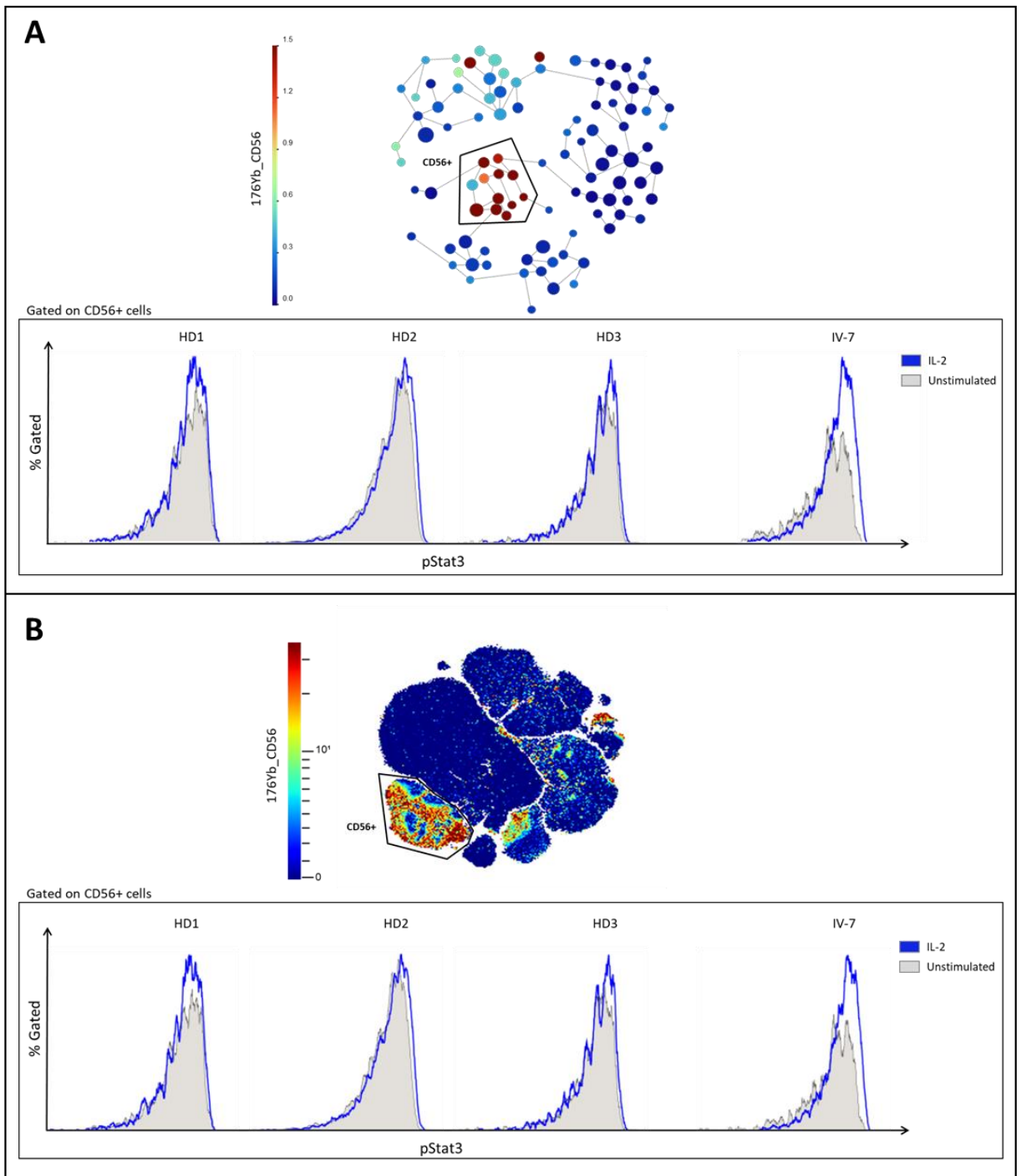
A) Quantification by Nanostring of 6 ISGs from blood of JAK1 patients, B) Type I interferon score calculated as the median fold increase of the 6 tested ISGs from Nanostring experiments. C) Quantification by RNAseq of 6 ISGs from blood of JAK1 patients. D) Type I interferon score calculated as the median fold increase of the 6 tested ISGs from RNAseq experiments. IV-7 was treated with baricitinib at the time of sampling.

**A****B**

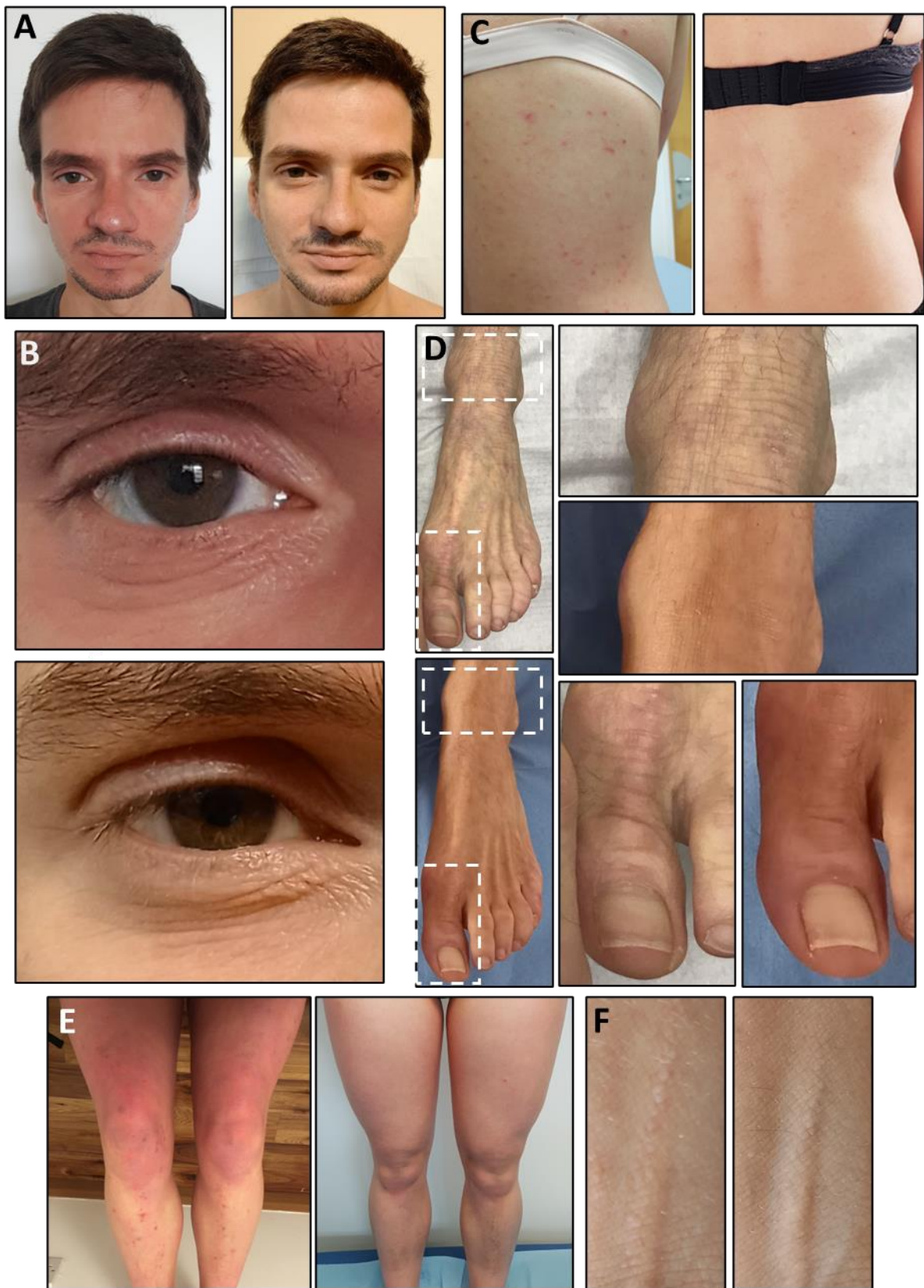
**Figure S6: Basal pSTAT1, pSTAT3, pSTAT5b and pSTAT6 levels in leukocytes JAK1 patients.** Bar graph representations of the phosphorylation status of STAT1, STAT5b and STAT6 on unstimulated fresh whole blood from 4 donors and 5 untreated patients. For IV-7 : Baricitinib discontinuation >72h. B: Heat mat representation of the phosphorylation status of STAT1, STAT3, STAT5b and STAT6 in unstimulated frozen PBMCs from 8 healthy donors and 6 patients measured by flow cytometry.



**Figure S7** : Phosphorylation status of STAT1, STAT3, STAT5b and STAT6 was measured by flow cytometry on frozen PBMCs from 6 healthy donors and 7 patients stimulated with IFN- $\gamma$  (400 UI/mL), IL-4 (50 ng/mL) or IL-6 (10 ng/mL) for 30 min. \*sample from patients treated with JAK inhibitors..



**Figure S8: STAT3 phosphorylation in NK cells from patient IV-7 and healthy donors whole blood in response to stimulation with interleukin 2:** Phosphorylation status of STAT3 was measured by mass cytometry on whole blood from 3 healthy donors and patient IV-7 stimulated with IL-2 (50 ng/mL). CD56+ NK-cells were gated using two algorithms: FlowSOM (panel A) and tSNE (panel B). On both the spanning tree (FlowSOM, panel A) and the scatterplot (tSNE, panel B), the colored continuous scale indicates the intensity of the CD56 marker. Histograms depict the pSTAT3 intensity in NK-cells identified using FlowSOM (panel A) and tSNE (panel B) either at basal state (grey) or following IL-2 stimulation (blue). Stimulation with IL-2 induced no phosphorylation of STAT3 in NK-cells from healthy donors whereas an increase was observed in those from the patient.

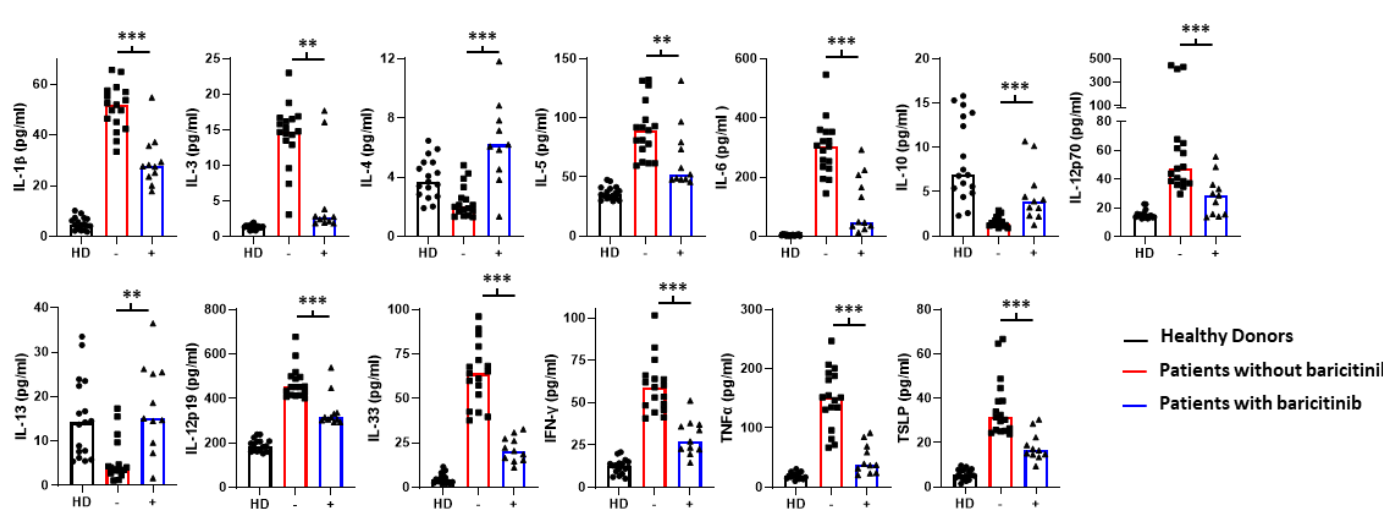


**Figure S9: Clinical response to JAK inhibitors**

Evolution of various skin manifestations of the disease under treatment with a JAK inhibitor: **A:** Improvement of facial inflammatory lesion-under treatment (right) compared to before treatment (left) in patients IV-5 (top). **B:** Improvement of eyelid dermatitis of patient IV-5 (untreated = left, treated = right). **C:** Resolution of neutrophilic prurigo-like exanthema of the trunk of patient IV-7 (untreated = left, treated = right) **D:** Good response of lichenification illustrated by a focus on patient III-13's left foot (untreated = top, treated = bottom) with focus on the first toe and the ankle. **E:** Resolution of neutrophilic infiltrated exanthema of the legs of patient IV-7 (untreated = left, treated = right) **F:** Improvement of inflammatory linear verrucous epidermal papules of the forearm of patient IV-5 (untreated = left, treated = right).



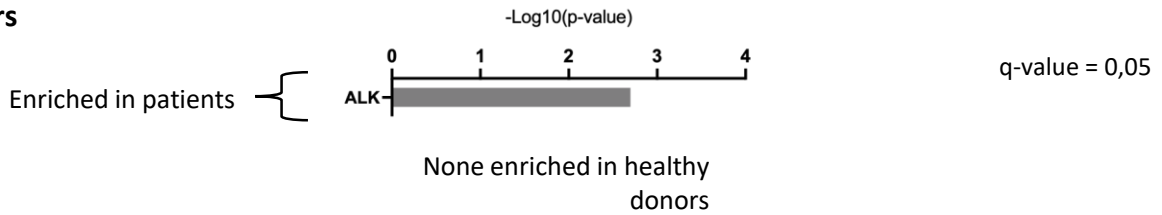
# Sup Fig 10



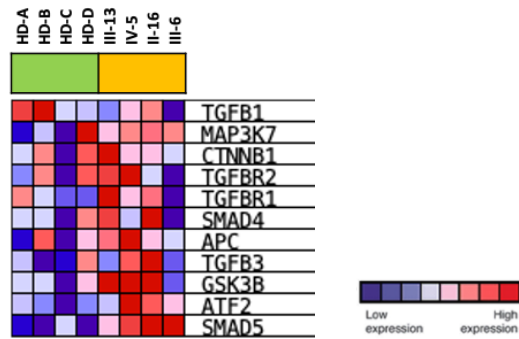
**Figure S10: Correction of Cytokine circulating levels by baricitinib in patients.** Representation of all the cytokine measurements performed in JAK1 patients before initiation of a treatment by JAK inhibitor or during treatment with baricitinib.

# Sup Fig 11

## A Gene set enrichment analysis comparing patients treated with baricitinib and healthy donors



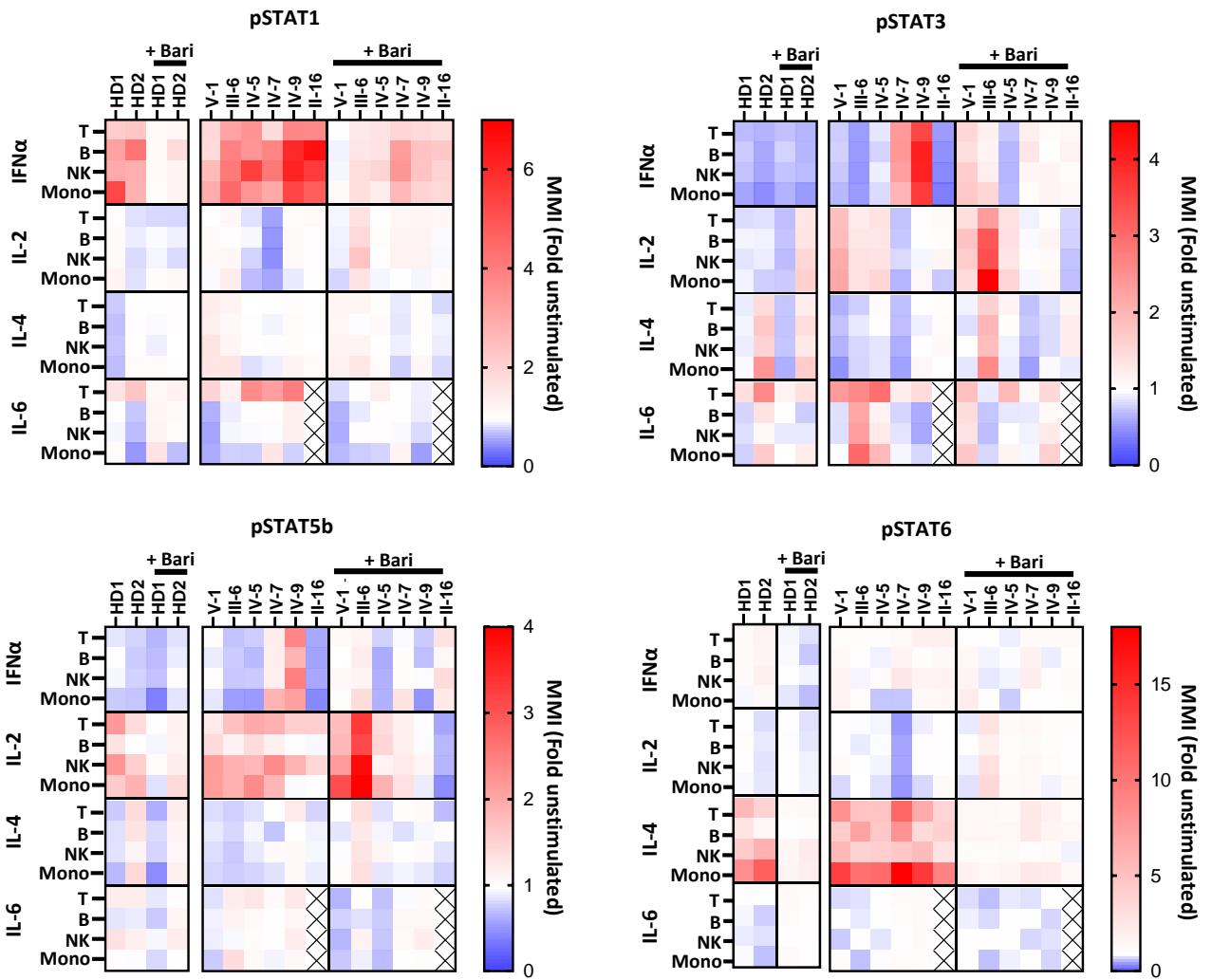
## B ALK pathway gene expression



### Figure S11: Transcriptomic signature of patients after initiation of JAK inhibitor treatments

**A)** Significantly enriched pathways in whole blood from patients after initiation of baricitinib (> 7 months) compared to healthy donors **B)** Detail of the genes from the identified pathway.

# Sup Fig 12

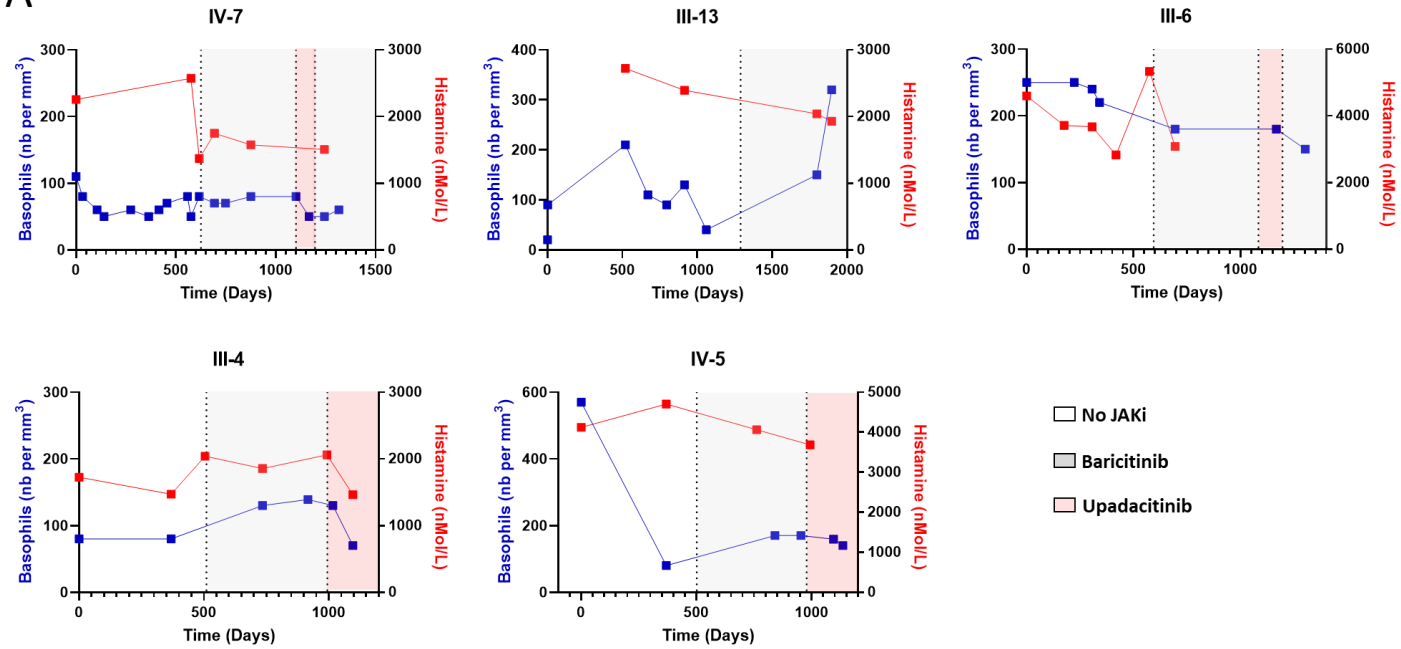


**Figure S12: STAT1, STAT3, STAT5b and STAT6 phosphorylation in patients and healthy donors PBMCs following various cytokine stimulations and in vitro treatment with baricitinib.**

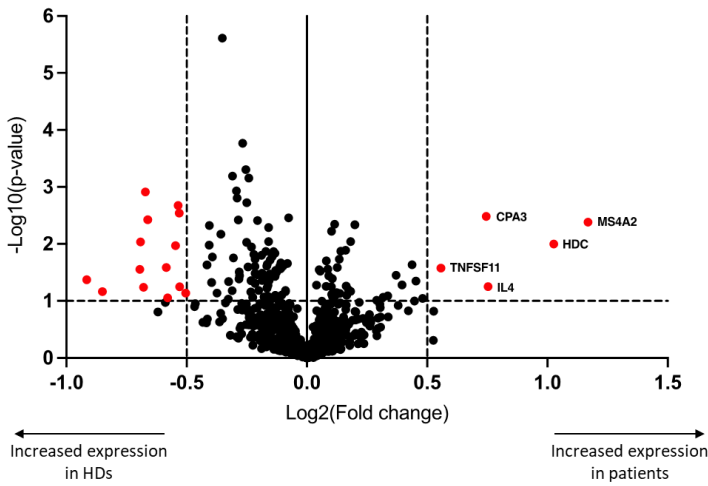
Phosphorylation status of STAT1, STAT3, STAT5b and STAT6 were measured by flow cytometry on frozen PBMCs from 4 healthy donors and 6 patients stimulated with IFN- $\alpha$ 2 (100 UI/mL), IL-2 (50 ng/mL), IL-4 (50 ng/mL) or IL-6 (10 ng/mL) for 30 min.

# Sup Fig 13

**A**



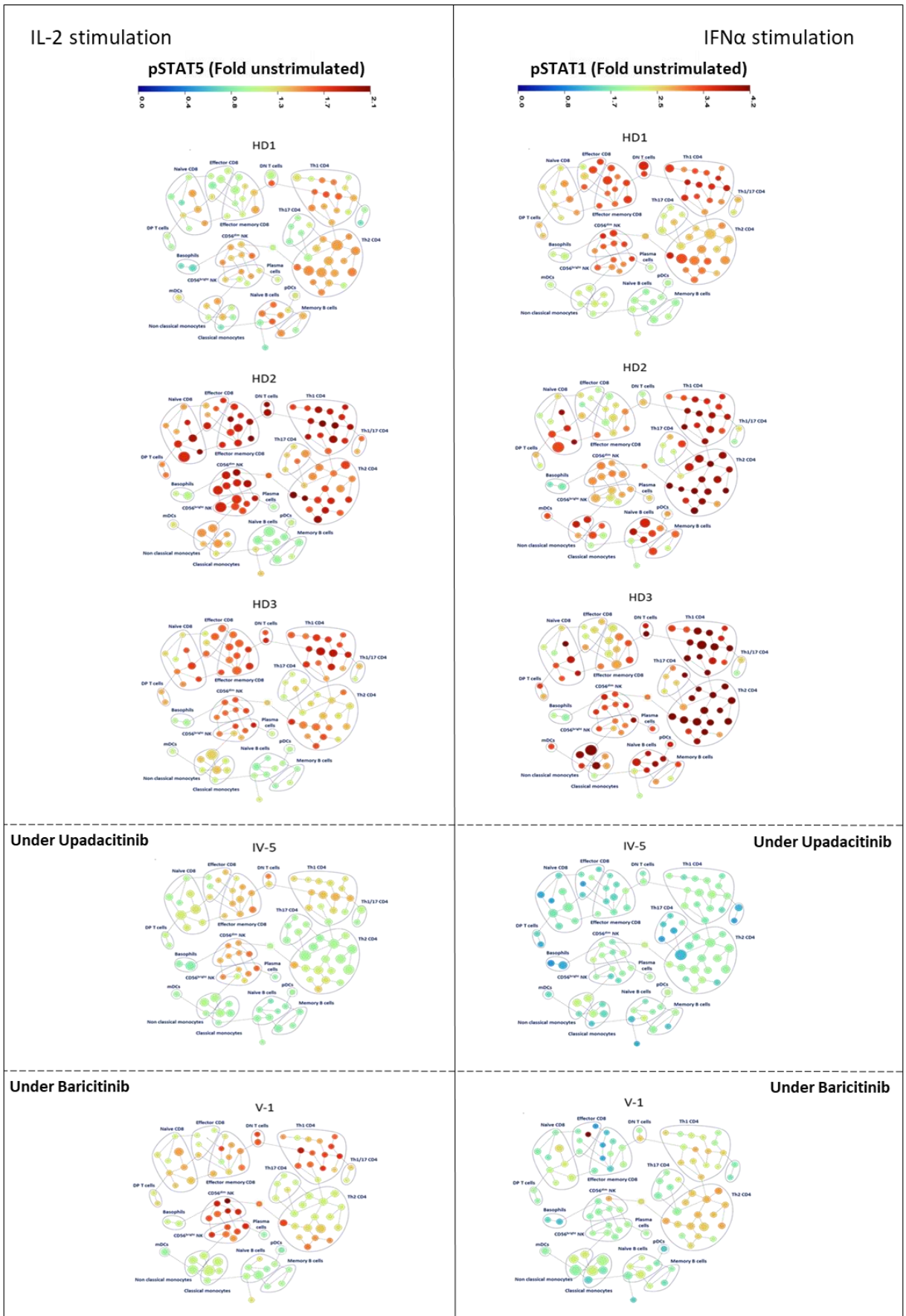
**B**



## Figure S13: Sustained basophilia under JAK inhibitor treatments. A)

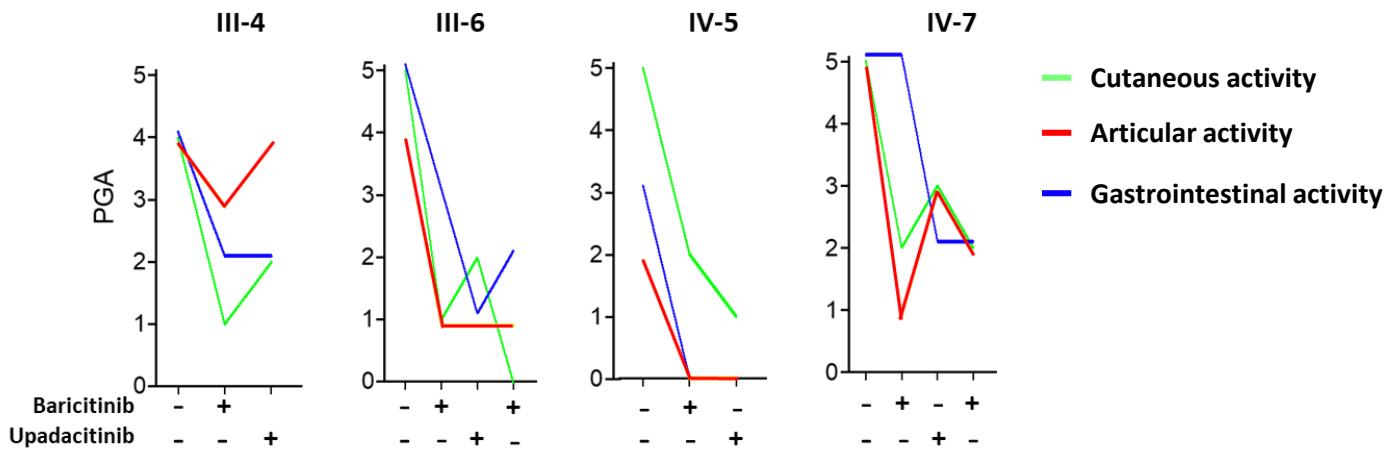
Follow up of blood basophil counts and blood histamine levels in patients treated with baricitinib (grey) or upadacitinib (light red). B)

Volcano plot representation of the gene expression analysis comparing treated patients (> 7 month) to healthy donors. Basophil related genes are among the top upregulated genes in treated patients.



**Figure S14: Control of canonical STAT phosphorylation by JAK inhibitors.** Spanning tree representation of the phosphorylation status of STAT1 after IFN $\alpha$  stimulation and STAT5b after IL-2 stimulation on unstimulated fresh whole blood from 3 donors and V-1 after initiation of baricitinib treatment (11 months) and IV-5 after initiation of upadacitinib treatment (2 months).

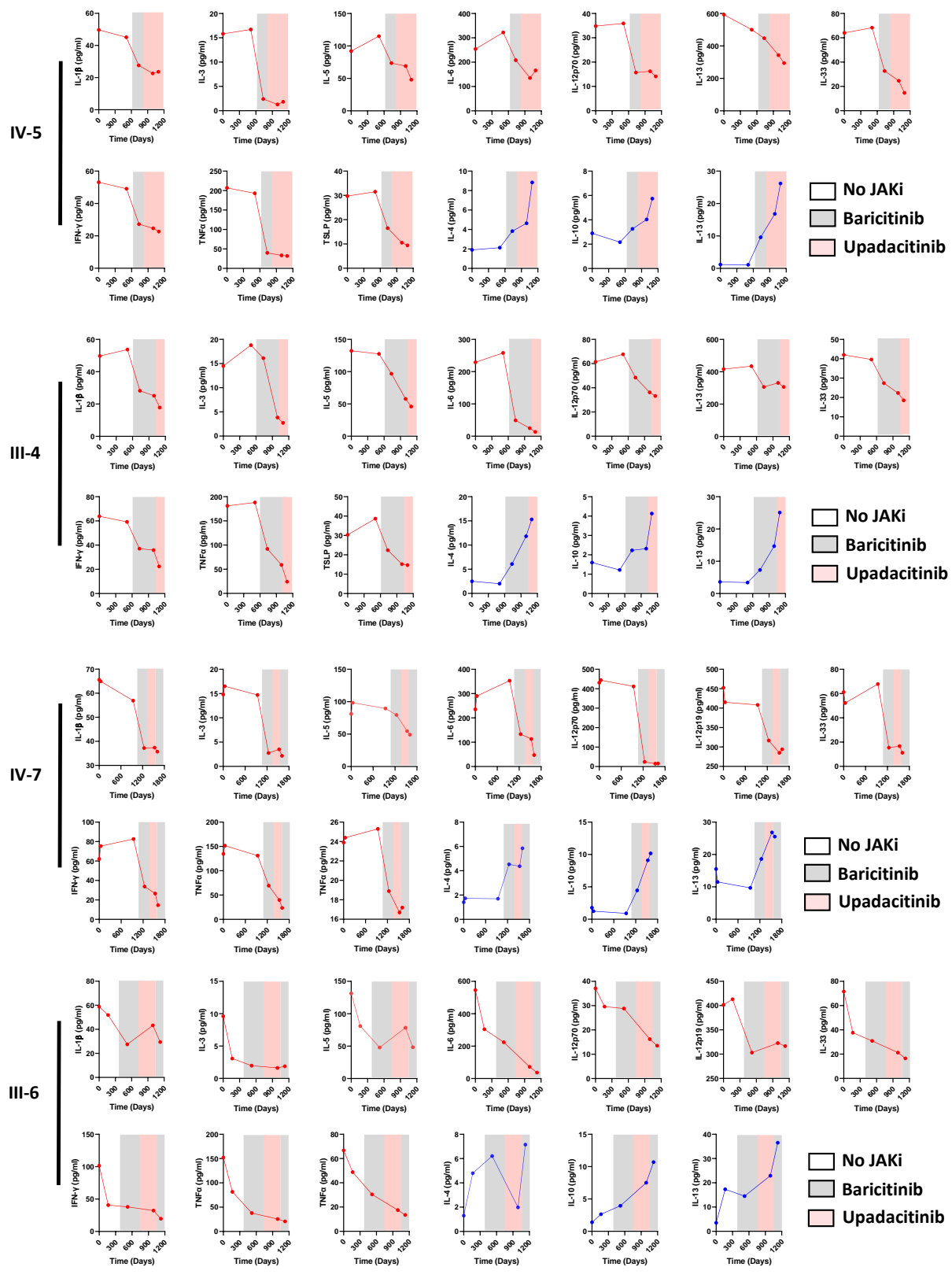
Figure S15



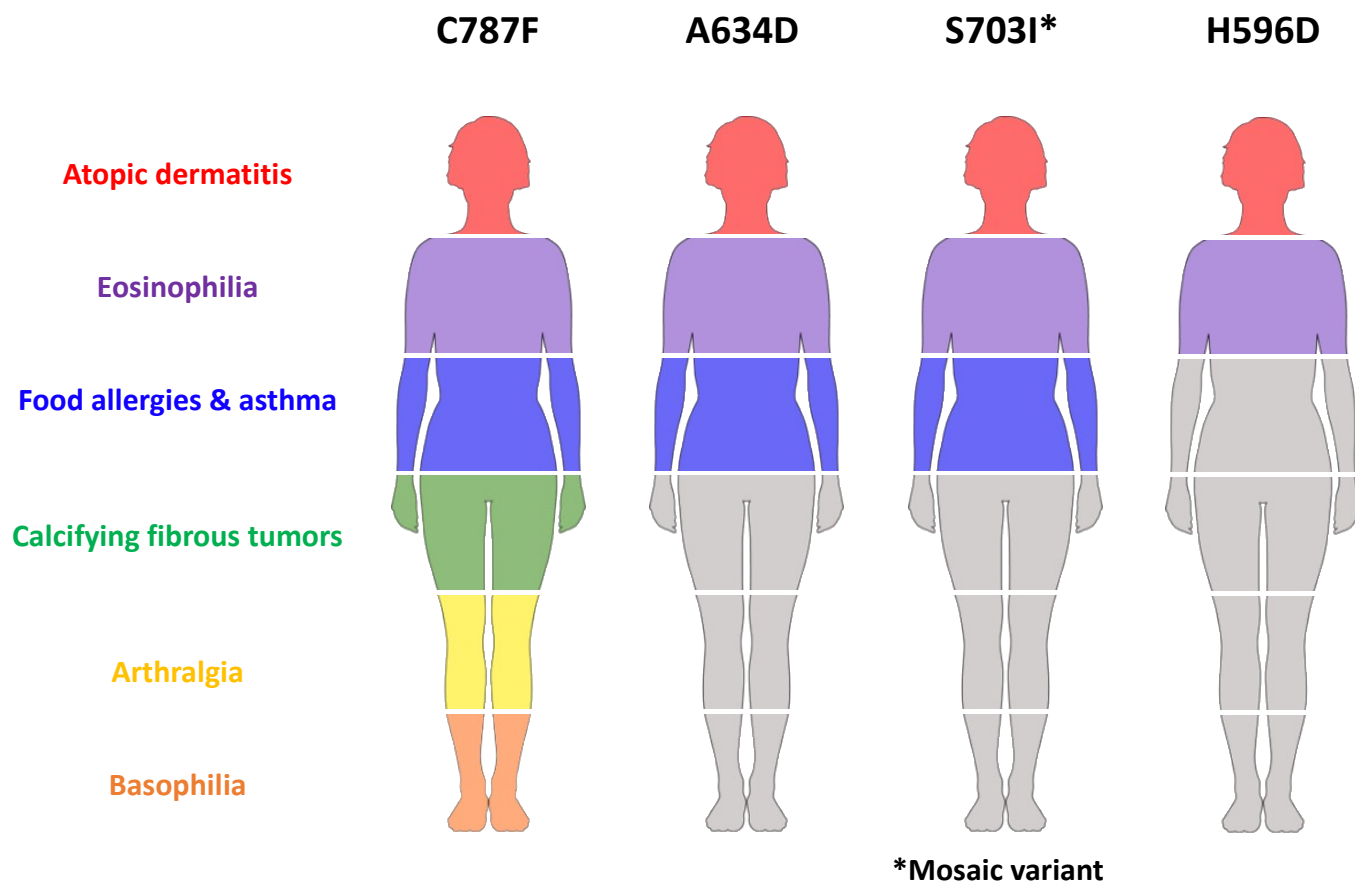
**Figure S15: Response to upadacitinib.**

Physician assessment score for the three main clinical features following treatment with baricitinib and upadacitinib.

# Sup Fig 16



**Figure S16: Cytokine profile in patients successively treated with baricitinib and upadacitinib.** Representation of the evolution of the circulating levels of cytokines in patients before the initiation of treatment with JAK inhibitors and during treatment with baricitinib (grey) or upadacitinib (light red).

**JAK1 GOF variants****Figure S17: Phenotypic overlap of JAK1<sup>C787F</sup> with other JAK1 GOF variants**

Based on Del Bel et al. J Allergy Clin Immunol. 2017 and Biggs et al. JCI Insight. 2022 (A634D), Grubber et al. Immunity. 2020 (S703I) and Takeichi et al. Front Immunol. 2021 (H596D). Also, notable clinical features encountered in the other JAK1 GOF variants included membranous nephropathy (S703I), hepatitis (H596D) and autism (H596D).



# Sup Fig 18

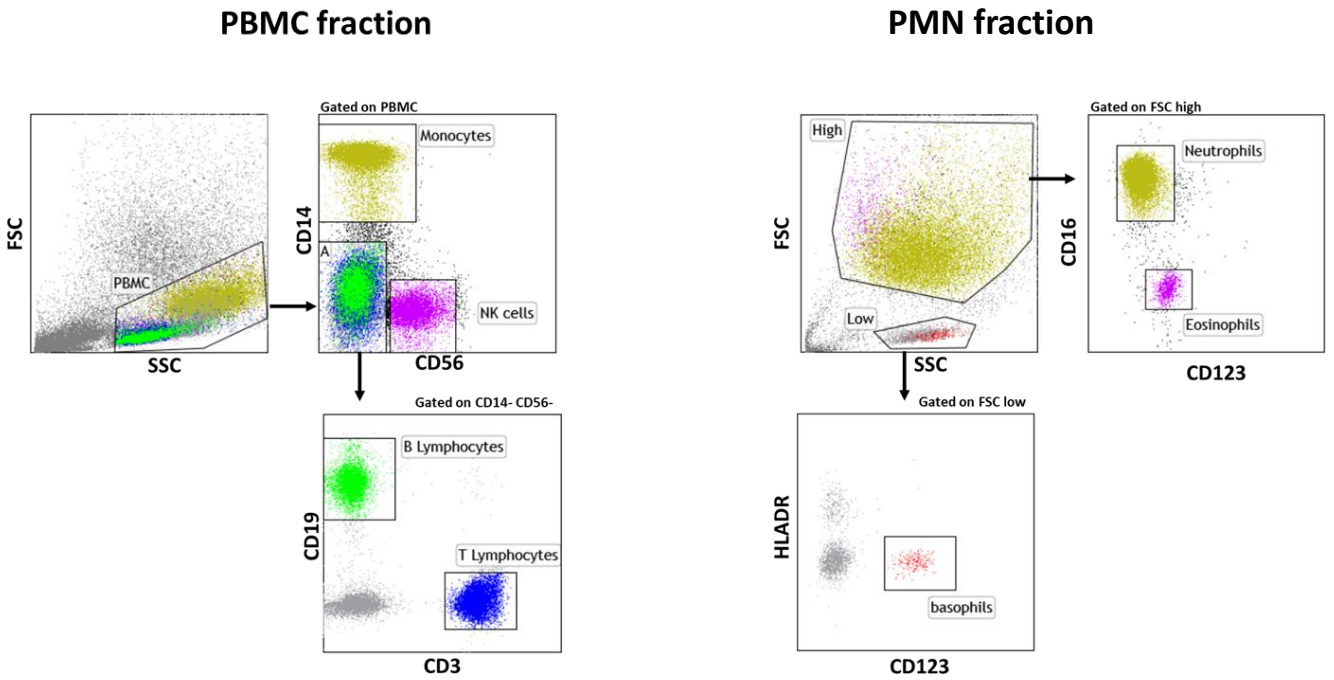


Figure S18: Gating strategy for cell sorting

### III. Supplementary Tables

Table S1 : Clinical findings

Patient N°	II-16	III-4	III-6	III-13	IV-5	IV-7	IV-9	V-1	V-2
Sex	F	F	M	F	M	F	F	M	M
Age on study (years old)	69†	56	53	56	30	23	27	3	1
Previous diagnosis	Atopic eczema Seronegative polyarthritis and severe asthma	Ichthyosis	Sarcoidosis	Ichthyosis	Addison's disease Eczema and atopic dermatitis	Crohn-like disease with spondylarthritis and neutrophilic dermatosis	Atopic dermatitis	Severe eczema	Not done
Failure to thrive / short stature	YES	NO	NO	NO	YES	NO	NO	YES	YES
Cutaneous features	Ichthyosis	Ichthyosis	Ichthyosis	Ichthyosis Atopic dermatitis	Ichthyosis Atopic dermatitis	Ichthyosis Atopic dermatitis Sweet syndrome	Ichthyosis Atopic dermatitis	Ichthyosis Atopic dermatitis	Ichthyosis Atopic dermatitis
Digestive features		Chronic watery diarrhea	Chronic watery diarrhea Food allergies	Chronic watery diarrhea	Chronic watery diarrhea Food allergies	Chronic diarrhea with occasional bleeding Ileitis Food allergies	Food allergies	Constipation with overflow Encopresis Anorexia Food allergies	Food allergies
Musculoskeletal features		Arthralgia	Arthralgia	Arthralgia	Arthralgia	Polyarthralgia			
Other clinical features	Severe asthma			Severe asthma	Adrenal insufficiency	Flushes Recurrent fevers		Major growth retardation	Major growth retardation
Calcified tumors	Yes	Yes	Yes	Yes	Yes	Yes	Yes	No	Unknown
CRP (N<5mg/L)	10	13.2	9.6	15.7	11.3	52	25	1	N
Hemogram	Mild PME elevation	Mild PMB elevation	Mild PMN & PMB & PME elevation	Mild	Mild PMN & PMB elevation	Mild PMN & PMB elevation	Mild PMN & PME elevation	Mild	Mild PME elevation

				PMN & PMB & PME elevation				PMN & PMB & PME elevation	
Gammaglobulin (g/L)	6	6.6	7.2	7.2	8.6	6.2	<del>3.8</del> 8.8	4.0	2.6
IgG / IgA / IgM (g/L) Bold = decreased*	<b>4.6</b> / 2.2 / <b>0.4</b>	6.5 / 3.0 / 0.59	6.7 / 3.6 / 1.1	7.8 / 2.2 / 0.7	6.8 / 2.1 / 0.9	<b>6.2</b> / 2.0 / 1.1	8.7 / 1.4 / 2.5	<b>3.9</b> / 0.5 / 0.5	<b>2.0</b> / x / x
IgE (UI/L) Bold = elevated for age	5	11	91	<b>1241</b>	<b>667</b>	26	<b>478</b>	<b>4488</b>	76.2
Blood Tryptase rate N<15 µg/L	4.2	3.4	5.5	3.3	6.6	3.7	3,8	3	ND
Blood histamine (nmol/L) N<700	1233	1725	3712	2720	4122	2256	4050	3958	3493
Previous treatments	Emollients, antiH, inhaled CS	Emollients, antiH, montelukast	Emollients, antiH, montelukast, ADA	Emollients, antiH, montelukast, inhaled CS	Emollients, antiH, montelukast, hydrocortisone,	Emollients antiH, montelukast, mesalazine, systemic CS, AZA MTX, IFX, ADA, USM, OMA	Emollients, antiH, topical CS	Emollients, antiH, topical CS	Emollients, antiH, topical CS

Abbreviations: F: female; M: male; ND: not done; PMN, Polymorphonuclear Neutrophil; PMB: Polymorphonuclear basophil; PME: Polymorphonuclear eosinophil; antiH: antihistamines; CS: corticosteroids; ADA: adalimumab; AZA: azathioprine; MTX: methotrexate; IFX: infliximab; USM: ustekinumab; OMA: omalizumab

\*Normal ranges for gammaglobulins:

- Adults = IgG: [6.5-12.0] g/L; IgA: [1.0-3.2] g/L; IgM [0.5-3.0]
- Child 1-2 years = IgG: [3.1-13.8] g/L; IgA: [0.3-1.2] g/L; IgM [0.5-2.2]
- Child 3-6 years = IgG: [4.9-16.1] g/L; IgA: [0.4-2.0] g/L; IgM [0.5-2.0]

†: deceased

Table S2: Auto immunity screening

		II-16	III-4	III-6	III-13	IV-5	IV-7	IV-9	V-1	V-2	V-4
<b>Nuclear</b>	<b>ANA</b>	-	-	-	-	1/160 *	-	-	1/160	-	-
<b>Tissue</b>	<b>ASMA</b>	-	-	-	-	-	-	-	-	-	-
	<b>AMA</b>	-	-	-	-	-	-	-	-	-	-
	<b>ANA</b>	-	-	-	-	-	-	-	-	-	-
	<b>Anti LKM1</b>	-	-	-	-	-	-	-	-	-	-
	<b>APCA</b>	-	-	-	-	-	-	-	-	-	-
	<b>Anti LC1</b>	-	-	-	-	-	-	-	-	-	-

ANA: anti-nuclear antibodies, ASM: anti-smooth muscle antibodies, AMA: anti-mitochondrial antibodies, APCA: anti-parietal cells antibodies; \*(type DFS70)

**Table S3: Treatment information for samples with cytokines dosages**

Patients	Immunomodulatory treatment	Dose	ttt duration (Days)	Cytokines (pg/ml)												
				IL1b	IL3	IL4	IL5	IL6	IL10	IL12 (p70)	IL13	IL23 (p19)	IL33	INFg	TNFa	TSLP
II-16	-			33,4	23	4,25	78,1	145,2	2,33	38,6	2,28	677,5	65,2	41,3	247	32,5
III-13	-			52,5	16,9	2,13	73,7	321	1,25	43,8	4,08	452,6	59,9	44,2	155	38,8
III-13	Baricitinib	2 mg x2/j	452	20,1	2,85	7,84	52,3	35,7	3,17	29,9	15,1	336,1	26,1	23,6	37,2	14,8
III-4	-			53,7	18,8	2,01	127,5	258	1,22	67,7	3,4	434,5	39,6	59,2	188	38,7
III-4	Baricitinib	2 mg/j	229	28,2	16,1	6,08	96,8	49,2	2,23	48,4	7,3	306,1	27,4	37,1	92,1	22,4
III-4	Baricitinib	2 mg/j	487	25,1	3,84	11,82	57,8	24,8	2,32	36,2	14,7	331,4	22,3	35,9	59,1	15,2
III-4	Upadacitinib	30 mg/j	114	17,8	2,73	15,3	45,9	13,4	4,13	33,2	25,1	306,4	18,5	22,4	24,2	14,7
III-6	-			51,9	3,07	4,8	81	304	2,65	29,6	17,3	413,1	37,6	40,7	81,6	48,8
III-6	Baricitinib	2 mg x2/j	117	27,5	1,97	6,21	47,9	224	3,94	28,8	14,5	303	30,9	37,9	37,9	30,4
III-6	Upadacitinib	30 mg/j	58	43,3	1,62	1,98	78,4	72	7,5	16,2	22,9	322,8	21,2	32,3	25,5	17,5
III-6	Upadacitinib	4 mg/j	99	29,4	1,87	7,15	48,3	36,8	10,7	13,5	36,5	316,6	16,5	19,7	20,8	13,5
IV-5	-			45,1	16,7	2,13	115	322	2,16	35,9	1,12	500	68,3	49,1	193	31,5
IV-5	Baricitinib	2 mg x2/j	436	27,6	2,4	3,83	73,51	208	3,26	15,7	9,6	447,6	32,7	27,2	39,9	16,5
IV-5	Upadacitinib	30 mg/j	10	22,6	1,29	4,64	69	135	4,03	16,2	16,8	343,1	24,6	24,7	33,4	10,5
IV-5	Upadacitinib	30 mg/j	122	23,6	1,84	8,84	48,1	166	5,74	14,1	26,2	294	14,7	22,7	32	9,4
IV-7	Infliximab	10 mg/kg/6w	486	65,6	14,8	1,41	81,2	235	1,78	431	15,5	452,4	61,2	62,1	134,8	23,9
IV-7	Infliximab	10 mg/kg/6w	528	64,9	16,5	1,73	98,4	290	1,24	444	11,5	415,2	52,2	75,4	151,6	24,4
IV-7	Baricitinib	2 mg x2/j	250	37,2	2,76	4,53	79,5	133	4,45	24	18,6	316,5	15,4	33,8	69,3	18,9
IV-7	Upadacitinib	30 mg/j	58	37,4	3,51	4,37	54,5	113	9,11	14,6	26,8	284,8	16,7	26,5	39,7	16,7
IV-7	Baricitinib	4 mg/j	135	35,7	2,18	5,85	49,1	47,2	10,17	15,5	25,5	294	11,2	14,6	23,5	17,2
IV-9	-			42,4	7,4	3,33	61,7	191	1,19	38,7	2,76	452	57,4	53,5	201	64,7
V-1	-			55,3	15,3	1,33	61,6	307	1,47	58,1	3,36	4546	96,1	60,3	67,1	25,7
V-1	Baricitinib	2 mg/j	288	57,5	12,9	1,38	93	353	1,14	47,3	3,48	519,4	86,1	66,1	71,7	25,1
V-1	Baricitinib	2 mg/j	400	54,8	17,7	1,35	131,5	293	1,27	55,6	1,68	539,5	20,5	51,2	85,2	28,6
V-4	-			37,5	16,2	3,9	62,61	194	1,89	40,7	4,33	497	42,5	48,4	135	44,6
HD1				6,21	1,34	2,03	36,9	1,64	4,42	14,8	23,5	162	2,46	13,1	26,4	4,2
HD2				3,05	1,33	6,46	38,2	2,23	15,3	14,3	14,5	207	3,54	13,9	17,2	9,7
HD3				4,54	1,36	1,91	32,7	1,57	4,87	12,6	14,2	166	2,1	16,1	14,2	8,1
HD4				4,87	0,83	4,08	32,2	1,68	6,8	14,1	16,7	239	1,9	7,9	18,2	7,8
HD5				1,85	1,49	4,57	29,6	3,63	14,8	18,9	13,7	162	4,28	13,7	26,5	9,1
HD6				4,09	1,38	4,29	40,2	2,21	13,5	13,6	16,2	239	8,1	14,2	24,6	4,5
HD7				2,59	1,97	3,5	35,2	2,58	5,97	12,5	22,4	159	9,5	12,8	30,9	7,2
HD8				2,24	1,42	2,84	34,3	3,43	12,4	13,4	23,9	225	3,41	15,1	21,8	3,5

Table S4: List of fluorochrome-conjugated antibodies used for membrane antigen staining

Target	Fluorochrome	Clone	Manufacturer
Mix 1			
CD14	APC-AF750	RMO52	Beckman Coulter
CD16	PEAF610	eBloCB16	Life technologies
CD3	APC	REA613	Miltenyi Biotec
CD8	AF405	3B5	Invitrogen
CD19	AF700	HIB19	Life technologies
IgD	PEVio770	REA740	Miltenyi Biotec
CD56	SB702	TULY56	Life technologies
Mix 2			
CD14	APC-AF750	RMO52	Beckman Coulter
CD16	PEAF610	eBloCB16	Life technologies
CD3	PE-Cy-5.5	SK7	Life technologies
CD8	AF405	3B5	Invitrogen
CD19	AF700	HIB19	Life technologies
IgD	PEVio770	REA740	Miltenyi Biotec
CD56	SB702	TULY56	Life technologies
CD123	APC	6H6	Life technologies
CD4	eFluor506	RPA-T4	Life technologies

Table S5: List of metal-isotope-tagged antibodies used for mass cytometry

Target	Label	Clone	Manufacturer
CD45	089Y	HI30	Fluidigm
CD196 (CCR6)	141Pr	G034E3	Fluidigm
CD19	142Nd	HIB19	Fluidigm
CD123	143Nd	6H6	Fluidigm
CD38	144Nd	5HIT2	Fluidigm
CD38	172Yb	5HIT2	Fluidigm
CD4	145Nd	RPA-T4	Fluidigm

CD8	146Nd	RPA-T8	Fluidigm
CD11c	147Sm	Bu15	Fluidigm
CD194 (CCR4)	149Sm	L291H4	Fluidigm
pSTAT5B	150Nd	47	Fluidigm
CD66b	152Sm	80H3	Fluidigm
pSTAT1	153Eu	4a	Fluidigm
CD3	154Sm	UCHT1	Fluidigm
CD27	155Gd	L128	Fluidigm
pSTAT3	158Gd	4/P-Stat3	Fluidigm
CD197 (CCR7)	159Tb	G043H7	Fluidigm
CD14	160Gd	M5E2	Fluidigm
CD183 (CXCR3)	163Dy	G025H7	Fluidigm
pNF-kB	166Er	K10-895.1	Fluidigm
pSTAT6	168Er	18	Fluidigm
CD45RA	170Er	HI100	Fluidigm
HLA-DR	173Yb	L243	Fluidigm
pSTAT4	174Yb	38	Fluidigm
CD56	176Yb	NCAM16.2	Fluidigm
CD16	209Bi	3G8	Fluidigm