



**HAL**  
open science

## Oxidation kinetics of a rough laminar pyrocarbon in O<sub>2</sub> -, H<sub>2</sub>O-and CO<sub>2</sub> -containing atmospheres

Marina Fradin, Gérard L Vignoles, Charlotte Ville, Guillaume Couégnat,  
Mathilde Ridard, Francis Rebillat

► **To cite this version:**

Marina Fradin, Gérard L Vignoles, Charlotte Ville, Guillaume Couégnat, Mathilde Ridard, et al..  
Oxidation kinetics of a rough laminar pyrocarbon in O<sub>2</sub> -, H<sub>2</sub>O-and CO<sub>2</sub> -containing atmospheres.  
Corrosion Science, 2023, 221, pp.111300. 10.1016/j.corsci.2023.111300 . hal-04135689

**HAL Id: hal-04135689**

**<https://hal.science/hal-04135689>**

Submitted on 21 Jun 2023

**HAL** is a multi-disciplinary open access archive for the deposit and dissemination of scientific research documents, whether they are published or not. The documents may come from teaching and research institutions in France or abroad, or from public or private research centers.

L'archive ouverte pluridisciplinaire **HAL**, est destinée au dépôt et à la diffusion de documents scientifiques de niveau recherche, publiés ou non, émanant des établissements d'enseignement et de recherche français ou étrangers, des laboratoires publics ou privés.

Colors for figures : For a proper readability of the figures, all require color printing.

## Graphical Abstract

### Oxidation kinetics of a rough laminar pyrocarbon in O<sub>2</sub>-, H<sub>2</sub>O- and CO<sub>2</sub>-containing atmospheres\*

Marina Fradin, Gérard L. Vignoles, Charlotte Ville, Guillaume Couégnat, Mathilde Ridard, Francis Rebillat

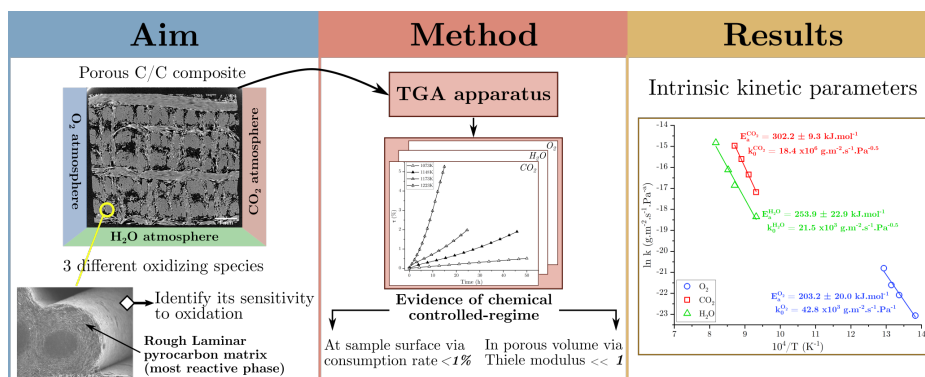

## Highlights

### **Oxidation kinetics of a rough laminar pyrocarbon in O<sub>2</sub>-, H<sub>2</sub>O- and CO<sub>2</sub>-containing atmospheres**

Marina Fradin, Gérard L. Vignoles, Charlotte Ville, Guillaume Couégnat, Mathilde Ridard, Francis Rebillat

- oxidation of a porous C/C composite under O<sub>2</sub>, H<sub>2</sub>O and CO<sub>2</sub> atmospheres ;
- matrix surface highly developed and exposed is the dominant reacting phase ;
- X-ray micro-tomography imaging and correlation technique characterizations ;
- oxidation chemical regime occurs in the porous volume and at the surface ;
- identification of intrinsic oxidation kinetics for a rough laminar pyrocarbon.

# Oxidation kinetics of a rough laminar pyrocarbon in O<sub>2</sub>-, H<sub>2</sub>O- and CO<sub>2</sub>-containing atmospheres

Marina Fradin<sup>a,b,\*</sup>, Gérard L. Vignoles<sup>a</sup>, Charlotte Ville<sup>a</sup>, Guillaume Couégnat<sup>a</sup>, Mathilde Ridard<sup>b</sup>, Francis Rebillat<sup>a</sup>

<sup>a</sup>Laboratoire des Composites ThermoStructuraux (LCTS), UMR 5801  
CNRS-Safran-CEA-Université de Bordeaux, 3 Allée de La Boétie, 33600 Pessac, France

<sup>b</sup>ArianeGroup SAS, 3 Rue de Touban, 33185 Le Haillan, France

---

## Abstract

The originality of this work relies on the identification of kinetic parameters for a rough laminar pyrocarbon material under three different oxidizing atmospheres. Thermogravimetric analysis was used to carry out oxidation tests on a ex-CVI porous C/C composite under O<sub>2</sub>-, H<sub>2</sub>O- and CO<sub>2</sub>-containing atmospheres at « low-temperatures ». They were proven to be in a chemical reaction-controlled regime in the porous volume of the material and at its external surface through the use of X-rays micro-tomography characterization technique and simple analytical model-based considerations. Activation energies of 203.2 kJ.mol<sup>-1</sup>, 253.9 kJ.mol<sup>-1</sup> and 302.2 kJ.mol<sup>-1</sup> were identified under O<sub>2</sub>, H<sub>2</sub>O and CO<sub>2</sub>.

*Keywords:* C. oxidation, C. kinetic parameters, A. ceramic matrix composites, A. carbon, B. 3D computed tomography, B. SEM.

---

## 1. Introduction

Carbon/Carbon (C/C) composites feature attractive properties, such as light weight, stability to high temperatures, huge specific strength, low thermal expansion coefficient, explaining their wide use as nozzle throat parts, re-entry vehicle thermal protections, and airplane brake disks for instance [1, 2, 3, 4, 5, 6].

---

\*. Working document - not for public release.

\*. Corresponding author. Tel : (+33) 5 56 84 33 03.

Email address: [fradin@lcts.u-bordeaux.fr](mailto:fradin@lcts.u-bordeaux.fr) (Marina Fradin)

In these types of applications, C/C composites are exposed to high temperatures and chemical environments containing oxidizing species such as H<sub>2</sub>O, CO<sub>2</sub> and O<sub>2</sub>, eventually leading to an ablation phenomenon and a non-negligible surface etching [7, 8, 9]. Graphite-like materials are well known to start degrading at  
10 673K under dioxygen and at 973K under H<sub>2</sub>O and CO<sub>2</sub>-containing atmospheres [10, 11]. Therefore, their kinetic behavior in specific oxidizing conditions has to be known in order to anticipate and precisely quantify the material degradation. The behavior of C/C composites under various oxidizing atmospheres has been studied during the last fifty years considering different parameters : recession  
15 rate, effective reactivity, roughness and morphologies, topological evolutions, either by experiments or modeling [7, 12, 13, 14, 15]. However, the leading role in these complex phenomena is held by the intrinsic kinetics of each of the carbonaceous phases in presence. Their identification still remains challenging.

In the last few years, several experimental and numerical studies, that must be  
20 mentioned, tackled the problem of identifying intrinsic kinetics of miscellaneous carbon materials, inbred or processed, under O<sub>2</sub> or H<sub>2</sub>O or CO<sub>2</sub> atmospheres. Smith [16] collected oxidation data from various carbonaceous materials under dry air at temperatures from 580K to 2200K and determined overall kinetics parameters. The behavior of an ex-pitch matrix and an ex-Chemical Vapor De-  
25 position (CVD) matrix under dry air were respectively studied by Drawin *et al.* [17] and Luo *et al.* [18]. The behavior of carbon particles under water vapour, among other complex atmospheres, was studied by Libby and Blake [19] at high temperatures using computational methods. Bradley *et al.* [20] identified heterogeneous oxidation kinetics for solid graphite particles under O<sub>2</sub>, H<sub>2</sub>O and  
30 CO<sub>2</sub>. Bertran *et al.* [21] determined kinetics parameters for an ex-resin type matrix under dry air and water vapor at temperatures between 623K and 773K. Besides, Qin *et al.* [22] identified kinetics constants for an ex-pitch matrix and for ex-PAN fibers under water vapor at 873 to 1673K. Golovina [23] studied the gasification of a graphite material under a CO<sub>2</sub> atmosphere at very high  
35 temperatures between 1600K and 2600K. The behavior of highly graphitized spectroscopic graphite powders under a CO<sub>2</sub> atmosphere at temperatures bet-

ween 973K and 1373K was evaluated by McKee *et al.* [24, 25]. Ergun [26] studied the behavior of different types of carbons (Ceylon graphite, activated carbon, and activated graphite) under a CO<sub>2</sub> atmosphere between 973K and 1773K.

40 Carbonaceous materials oxidation under O<sub>2</sub>, H<sub>2</sub>O and CO<sub>2</sub> was also studied considering the energies of the adsorption step of the reactants and desorption step of CO<sub>(g)</sub> as a product from the surface of different carbon materials. Rossberg [27] suggested that the slow and determining step is the dissociation of an oxygen atom to the active carbon site and compared the dissociation energy to  
45 the true activation energies of the reaction. For spectroscopic carbons oxidized at temperatures from 793K to 1693K under O<sub>2</sub>, a dissociation energy of 246.9 kJ.mol<sup>-1</sup> was found, one of 485.3 kJ.mol<sup>-1</sup> under H<sub>2</sub>O, and finally one of 527.2 kJ.mol<sup>-1</sup> under CO<sub>2</sub>. Kelemen and Freund [28] found an energy of 133 and 209 to 251 kJ.mol<sup>-1</sup> for the adsorption step of O<sub>2</sub> and CO<sub>2</sub> respectively on glassy  
50 carbons at 573K. Karlström *et al.* [29] studying biomass char proved that the adsorption step of O<sub>2</sub>, H<sub>2</sub>O and CO<sub>2</sub> on C<sub>(s)</sub> atoms differ by their activation energies with reported values of 1, 223 and 226 kJ.mol<sup>-1</sup> respectively. On the other hand, they found activation energies for the desorption step of CO<sub>(g)</sub> of 1, 192 and 234 kJ.mol<sup>-1</sup>.

55 In a nutshell, oxidation kinetics data under O<sub>2</sub>, or H<sub>2</sub>O or CO<sub>2</sub> oxidizing atmospheres are really dispersed because of the different natures of the carbonaceous materials studied in terms of graphitic structure and reactivity. This highlights the fact that the behavior of each carbonaceous material under specific oxidizing conditions has to be precisely studied and cannot be inferred from an another  
60 material without a loss of accuracy. Besides, this short bibliographical review underlines that there is a lack of oxidation kinetics data for pyrocarbon (PyC) materials in literature. On the other hand, oxidation kinetics data of one specific carbon material under three different oxidative atmospheres are scarce, except the work of Bradley *et al.* [20] on graphite particles which are highly organized  
65 materials, and the adsorption-desorption considerations of reactants and CO-product from Rossberg [27] and Karlström *et al.* [29] which constitute for most of them very longstanding experimental studies. Those kinds of works are even

scarcer, if not inexistent, for PyC materials.

In this work, we are aiming at investigating the oxidation kinetic behavior of a  
70 Rough Laminar (RL) PyC matrix under  $O_2$ ,  $H_2O$  and  $CO_2$ -containing atmos-  
pheres. RL pyrocarbon is a very important material in space technology but  
unavailable in bulk form, making the determination of its intrinsic reactivity  
extremely difficult. Indeed, RL PyC is only produced by Chemical Vapor Infil-  
tration (CVI) [30, 31, 32, 33] inside porous media developing a large internal  
75 surface area and with a very specific set of processing parameters [34].

To do so, the material under consideration is a 3D needle-punched highly porous  
C/C composite, in which the raw fibrous architecture has been covered in vo-  
lume with an RL PyC matrix by CVI. Hence, the matrix represents the only and  
most widespread surface in the porous volume of the material. The fibers, less  
80 directly exposed to the oxidizing gases, are also far less reactive to oxidation than  
the matrix due to their intrinsic characteristics. It is therefore possible to assume  
that oxidation affects the matrix only. The phenomenon of competition between  
reaction and diffusion during the oxidation process of carbon materials and C/C  
composites has been extensively reported in the literature to misrepresent the  
85 kinetic behavior of the material when oxidation is limited by the diffusion of the  
oxidizing species to the carbon surface [9, 10, 14, 35, 36, 37, 38, 39]. For that  
reason, a complete chemical-controlled regime freed from diffusion effects in the  
porous volume of the material is targeted in this study. So that, the identified  
kinetics related to the oxidation of the matrix, which occupies the overall devel-  
90 oped surface in the porous volume of the material, could be defined as intrinsic.  
The methodology to determine intrinsic oxidation kinetics for the RL PyC ma-  
trix followed in this study thus contains several experimental and validation  
steps. Oxidation tests are carried out in a Thermogravimetric Analysis (TGA)  
apparatus and kinetics parameters are extracted from mass loss results. Surface  
95 and volumic oxidation morphologies are analyzed using a 3D-image characteri-  
zation technique and Scanning Electron Microscopy (SEM) imaging. The exist-  
ence of the targeted chemical regime at the sample surface and in its porous  
volume is verified using experimental and analytical modeling considerations.

Finally, comparisons of the identified kinetics parameters with literature data  
 100 are discussed.

## 2. Materials and Methods

### 2.1. Materials

The oxidation behavior of a partly infiltrated 3D needle-punched C/C composite is investigated in this study. The preform is made of carbon yarn sheets  
 105 of ex-PAN fibers, horizontally and perpendicularly stacked (X, Y planes), then  
 needle-punched in the transverse direction (Z) to hold them together. Fig. 1  
 gives an illustration of the architecture. Its porosity is estimated at  $28\% \pm 2\%$   
 [40, 41]. The fabrication process of the ex-PAN fibers is conventional, as descri-  
 110 bed in the work of Frank *et al.* [42]. The Isobaric and Isothermal CVI process  
 (I-CVI) is used to fill the preform with a pyrocarbon matrix until a solid matrix  
 fraction of  $35 \pm 3\%$ , a residual porosity of  $37 \pm 2\%$  and an apparent density of  
 $1.25 \pm 0.1 \text{ g.cm}^{-3}$  are reached.

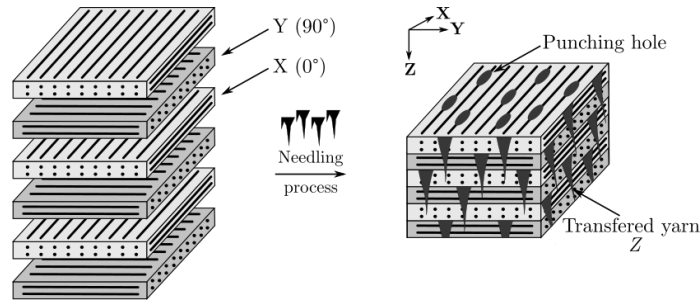

FIGURE 1 – Schematic illustration of the 3D needle-punched C/C architecture.

115 The overall organization of the material is displayed on Fig. 2 through X-  
 ray micro-tomography and SEM images and the types of pores constituting the  
 porous volume of the material are indicated. The pores size associated to this  
 type of C/C composites is different from the IUPAC format and is given as



120 follows : pores sizes ranging from 200 to 1000  $\mu\text{m}$  are inter-plies macroscopic pores, ones between from 10 to 200  $\mu\text{m}$  are mesoscopic inter-yarns pores and the ones below 10  $\mu\text{m}$  are intra-yarn microscopic pores [43].

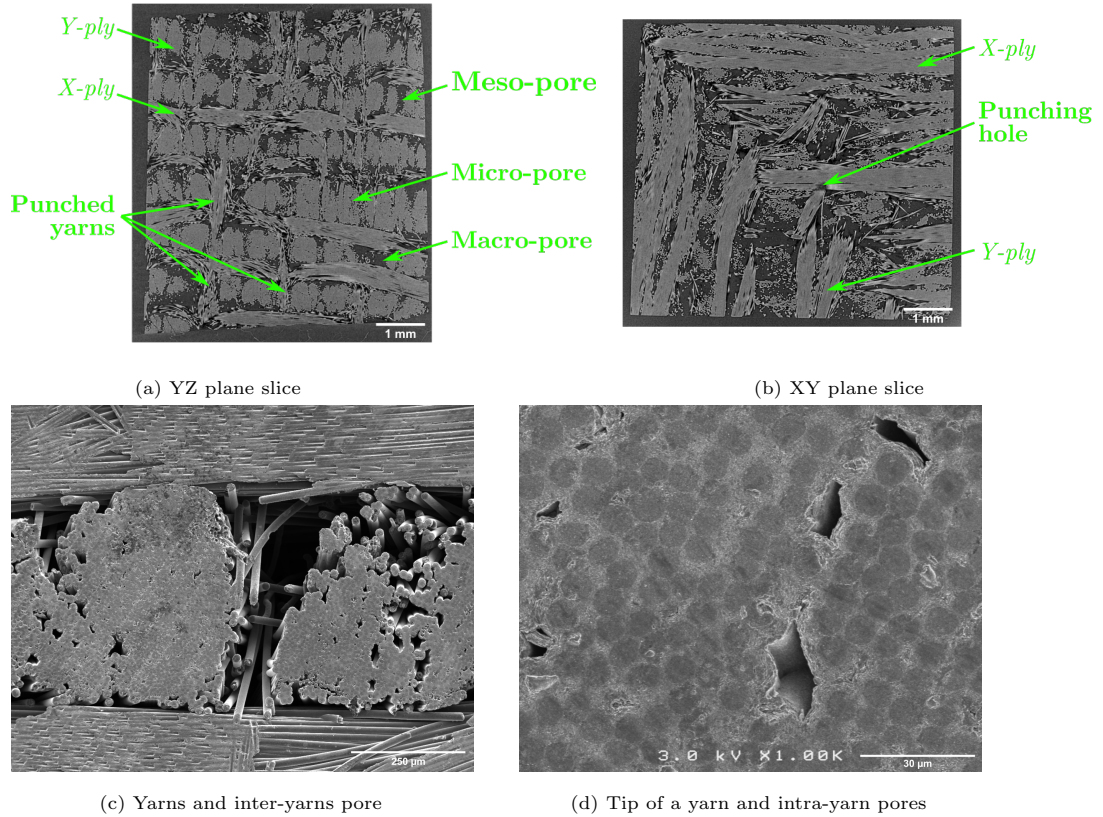

FIGURE 2 – Visualization of the organization of the material at different scale. (a, b) Core slices of X-ray micro-tomography of the porous C/C sample according to the (a) YZ-plane and (b) XY-plane. (c, d) SEM images of (c) the inter-yarns area and (d) the tip of a yarn.

## 2.2. Sample preparation

125 Cubic samples of 6 mm edge size are used. They have been previously cut with a wire saw in a C/C massive block. Faces were polished on silicon carbide

discs in order to standardize the dimensions.

### 2.3. Characterization of the carbon textures

130 An optical microscope Nikon ME600L equipped with a graduated polarizer and an analyzer is used to determine the fibers and matrix anisotropy. The extinction angle  $A_e$  is measured using the Polarized Light Optical Microscopy (PLOM) method established by Gillard *et al.* [44]. A LabRAM HR (Horiba-Jobin Yvon) Raman spectrometer with a wavelength of 632.8 nm is employed  
135 to assess the Full Width at Half Maximum of the D-band ( $FWHM_D$ ), the Half Width at Half Maximum of the G-band ( $FWHM_G$ ) and the ratio of the D-band intensity to the G-band intensity ( $I_D/I_G$ ). These parameters are known to be related to the amount of in-plane defects and graphitization degree of pyrocarbons [45, 46, 47]. The in-plane coherence length  $L_a$  of the cristallites  
140 of the fibers and the matrix is undertaken using the method established by Mallet-Ladeira *et al.* [48] based on the  $FWHM_G$  parameter.

### 2.4. Oxidation test equipment

The objective of this study is to assess the behavior of a porous C/C composite towards three different types of oxidizing species : (1)  $O_{2(g)}$  associated to the reaction equation Eq. 1 in a dry air-like atmosphere mainly producing  $CO_{2(g)}$ , according to thermodynamical considerations under 973K [49, 50]; (2)  $H_2O_{(g)}$  related to Eq. 2 in a water vapour mix; (3)  $CO_2$  corresponding to Eq. 3.

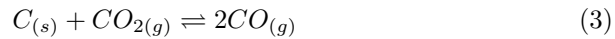
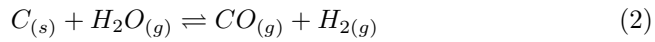

A SETARAM Setsys 1600 TGA reactor was used to carry out the oxidation experiments. The internal diameter of the cylindrical reaction chamber is 17.8

145 mm and it is surrounded by a cylindrical resistive heating. A highly accurate  
balance, with a precision as high as  $1 \times 10^{-5}$  g, is positioned at the top of the  
apparatus to measure sample weight loss during testing. A thermocouple sensor,  
located close to the sample, monitors the chamber temperature. Fig. 3 gives a  
schematic diagram of the complete experimental facility. Cubic samples were  
150 installed in an airy basket-like crucible made of alumina and platinum connected  
to the balance. They were oriented in a way that needle-punched fibers were  
pointing downwards.

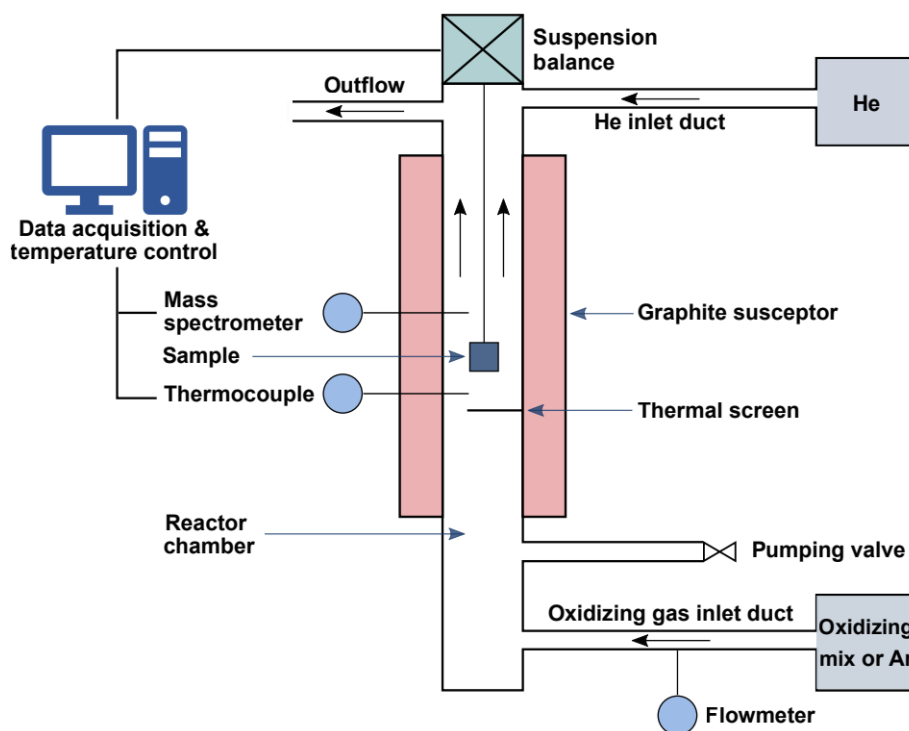

FIGURE 3 – Diagram of the TGA equipment.

155 The oxidizing atmospheres were produced by mixing each of the oxidizing spe-  
cies ( $O_2$ ,  $H_2O$  or  $CO_2$ ) with dinitrogen ( $N_2$ ) in a 20%-80% proportion in partial  
pressure at standard conditions. The overall oxidizing gas flow was set to  $2 \text{ L.h}^{-1}$   
and injected from the bottom of the chamber.

Heating and cooling steps were carried out under a neutral atmosphere of argon.  
160 A 10 K.min<sup>-1</sup> rate was used to reach the desired temperature. The oxidation process has been carried out under isostatic temperatures. The temperature range under each atmosphere is selected in such a way that the lowest temperature corresponds to the first temperature under which a mass loss is observed. The other temperatures of the range are selected to ensure the oxidation process  
165 stays in a chemical-controlled regime (see Section 3.4 for further details). The oxidizing bearing temperatures were : 723 to 773K for the dry air atmosphere ; 1073 to 1223K for the water vapour atmosphere ; and 1073 to 1148K for the CO<sub>2</sub> atmosphere, respectively.

#### 170 2.5. Surface observations

The examination of the samples post-test surface morphologies, and especially the determination of the dominant reacting phase, was performed using a Hitachi S4500 FEG SEM. An electron beam voltage of 3 kV and a working distance of 15 mm were chosen.

#### 175 2.6. Volumic characterizations

The evolutions of the material in its porous volume due to oxidation were tracked with an innovative approach relying on 3D X-ray computed microtomography ( $\mu$ CT) and image correlation. A laboratory tomograph (GE v|tome|x  
s research edition, General Electrics, USA) was used to acquire pre- and post-  
180 test images of the samples. The tomograph X-rays source was set on a tension of 100 kV and an intensity of 250  $\mu$ A. The exposure time was 1000 ms. A total of 2000 images were acquired per scan. The spatial resolution was 4.75  $\mu$ m per voxel unit.

Post-test images were then registered with respect to their pre-test reference  
185 state. The registration was performed using an in-house digital volume correlation software. The sought mapping is assumed to be described by a global affine transformation, including rigid translation and rotation of the specimen. It also

possibly includes a homothetic scaling to accommodate small variations in the images resolution. Also, prior to the registration, images are standardized to  
 190 mitigate differences in brightness and contrast between specimens. The transformation parameters are found by minimizing the gray level residual between the mapped image and the reference one. A difference image is finally obtained by subtracting the registered image from the reference one using the *Image Calculator* function in *Fiji* software [51].

195

### 2.7. Data processing

The primary oxidation behavior with time is evaluated with the burn-off ratio  $\tau$  (%) defined as the mass loss of the sample at a specific time compared to its initial mass  $m_0$  (g) :

$$\tau = 1 - \frac{m_i}{m_0} \% \quad (4)$$

where  $m_i$  (g) is the sample mass at time  $i$ .

Then, the oxidation activity  $j$  (g.m<sup>-2</sup>.s<sup>-1</sup>) is calculated from Eq. 5, where  $\dot{\tau}$  (%.s<sup>-1</sup>) is the slope of the burn-off evolution curve in its linear part :

$$j = \dot{\tau} m_0 \frac{1}{S_{vol}} \quad (5)$$

$S_{vol}$  (m<sup>2</sup>) is the surface area developed by the matrix in the open volume of the porous C/C sample, satisfying the following equation :

$$S_{vol} = \sigma_v V_{geo} \quad (6)$$

where  $V_{geo}$  (m<sup>3</sup>) is the geometric volume of a sample and  $\sigma_v$  (m<sup>-1</sup>) is the internal surface area. For the C/C composite of this study,  $\sigma_v$  has been determined by X-ray  $\mu$ CT and image processing with a numerical method set by Charles *et al.*  
 200 [52]. For a C/C composite featuring a porosity rate of 37%, it is equal to  $24.6 \times 10^4$  m<sup>-1</sup>.

$j$  also satisfies Eq. 7 :

$$j = k P_{ox}^a \quad (7)$$

where  $P_{ox}$  (Pa) is the partial pressure of the oxidizing species and is  $a$  the reaction partial order. It is commonly taken equal to 1 under  $O_2$  [7, 21, 47, 16], and  
 205 will be considered equal to 0.5 under  $H_2O$  and  $CO_2$  [20, 22].

In Eq. 7,  $k$  ( $g.m^{-2}.s^{-1}.Pa^{-a}$ ) is the oxidation reactivity and is assumed to satisfy an Arrhenius law as follows :

$$k = k_0 \exp\left(\frac{-E_a}{\mathcal{R}T}\right) \quad (8)$$

where  $k_0$  ( $g.m^{-2}.s^{-1}.Pa^{-a}$ ) is the pre-exponential factor,  $E_a$  the reaction activation energy ( $J.mol^{-1}$ ),  $\mathcal{R}$  the universal ideal gas constant ( $J.mol^{-1}.K^{-1}$ ) and  $T$  the reaction temperature (K).

210

Finally, the consumption ratio per geometrical surface unit, defined as the ratio between the number of carbon moles consumed and the amount of available oxidizing species per sample external surface unit, is expressed by  $\zeta$  ( $\%.mm^{-2}$ ) as follows :

$$\zeta = \frac{n_C^{cons.}}{n_{ox}^{avail.}} \frac{1}{S_{geo}} \quad (9)$$

where  $S_{geo}$  is the geometrical external surface of the sample ( $mm^2$ ). The ratio between the number of carbon moles consumed and the amount of available oxidizing species ranges between 0% (*i.e.* no consumption) to 100% (*i.e.* complete consumption by the sample external surface). It might increase with temperature due to the kinetic activation. Consequently, for a 6 mm edge size cubic  
 215 sample,  $\zeta$  would go from  $0\%.mm^{-2}$  to  $4.16 \times 10^{-1}\%.mm^{-2}$ .

### 3. Results and discussion

#### 3.1. Fibers and matrix textures and structures

Fibers and matrix being different types of materials, their textures and structures features need to be characterized first. Table 1 summarizes the pyrolytic  
 220 texture and structure characteristics of the fibers and the matrix phases assessed with the methods described in Section 2.3. With a very low extinction angle,

the fibers displayed a characteristic transversely isotropic texture of ex-PAN materials [53]. Coupled data from PLOM and Raman indicate that the matrix is indeed an RL PyC [44]. With a larger  $FWHM_D$  value and a lower  $HWHM_G$  value, the matrix graphitic planes contains a larger amount of defects than fibers ones and is less organized [6, 46], suggesting a higher sensitivity to oxidation, according to the works of Ehrburger *et al.* [54]. Besides, the in-plane coherence length  $L_a$  is greater for the fibers than for the matrix.

230

	$A_e$	$FWHM_D$	$HWHM_G$	$I_D/I_G$	$L_a$ [48]
	$^\circ$	$cm^{-1}$	$cm^{-1}$	-	$nm$
<b>Fibers</b>	$0.8 \pm 0.1$	$73.2 \pm 1.5$	$24.7 \pm 0.2$	$4.9 \pm 0.2$	$8.3 \pm 0.1$
<b>Matrix</b>	$13.9 \pm 0.4$	$97.8 \pm 1.6$	$32.3 \pm 0.4$	$4.3 \pm 0.1$	$6.9 \pm 0.1$

TABLE 1 – Fibers and matrix micro-textural and structural parameters obtained from PLOM technique and Raman spectroscopy.

### 3.2. Post-tests surface morphologies and volumic porous topologies

#### 3.2.1. Oxidation morphologies and dominant reactive phase

Fig. 4 displays SEM micrographs of the C/C material constituents, *i.e.* fibers and matrix, at a pristine state and after oxidation under the three oxidizing atmospheres at the highest relative temperature.

Compared to the pristine state on Fig. 4a, the lengthwise matrix surface displays marks of oxidation under the three considered oxidizing atmospheres. One can notice that these oxidation patterns differ from an oxidative species to another. Whereas the matrix surface is pitted under  $O_2$  on Fig. 4b, it displays a laminated appearance under  $H_2O$  on Fig. 4c and a dented one under  $CO_2$  on Fig. 4d.

240

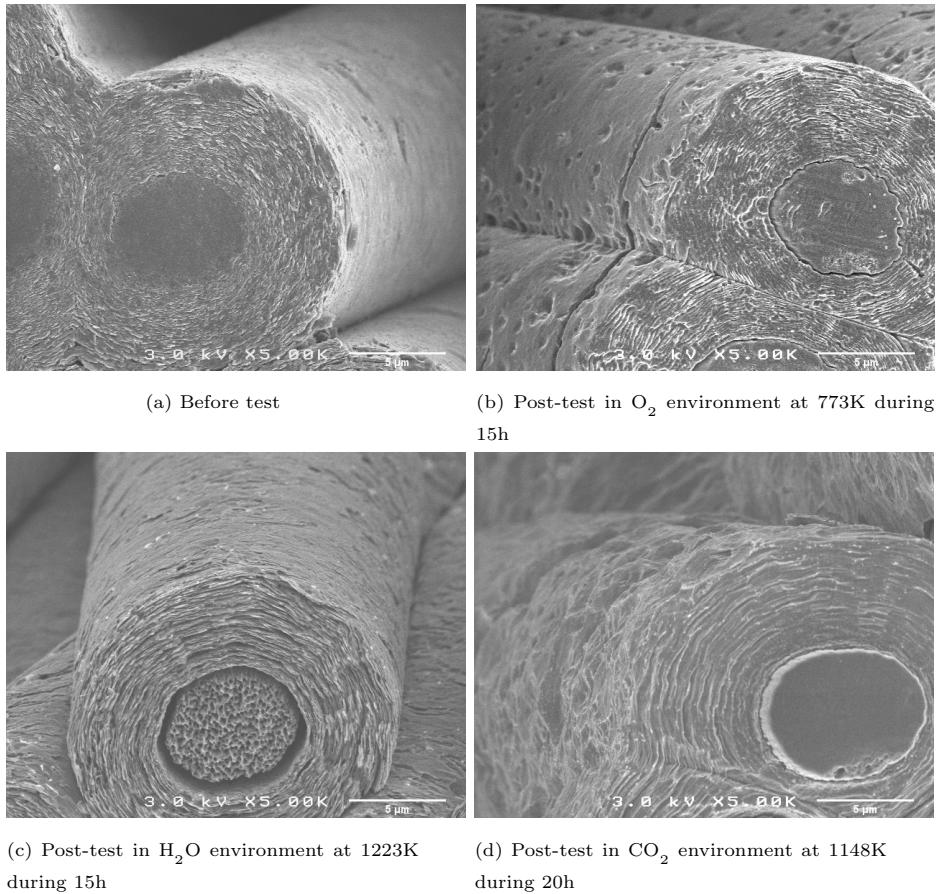

FIGURE 4 – SEM images of the tip of a yarn from the C/C samples at different states : (a) before test ; post-test (b) under O<sub>2</sub> at 773K during 15h ; (c) under H<sub>2</sub>O at 1223K during 15h ; under CO<sub>2</sub> at 1148K during 20h.

On the other hand, under O<sub>2</sub> and CO<sub>2</sub> atmospheres, fibers are stripped of the  
 245 matrix on a small length because of their lower oxidation reactivity. Besides,  
 they feature very few oxidation marks, except some pits at their extreme sur-  
 face. This indicates that the matrix is the only reacting phase under O<sub>2</sub> and  
 CO<sub>2</sub>. Nevertheless, one has to exercise caution under H<sub>2</sub>O because of the higher  
 degradation at the tip of the fibers compared to the other atmospheres. Here,  
 250 the exposed fiber sections seem to recede at least as much as the section of the  
 matrix at the tip of the yarn. However, as it will be detailed in the following



section, the affected surface of the matrix is much larger than that of the fibers, because it does not only concern the tip of the yarns, but the entire porous volume of the material. Hence, the matrix overall reactivity in the porous material holds the dominant role.

### 3.2.2. Evolution of the volumic porous topology

Fig. 5 displays core slices of the pre-test  $\mu$ CT images and residues of oxidation for each of the oxidizing atmospheres at the highest relative temperature. White areas indicate the pristine material and the colored ones highlights the oxidized parts (*i.e.* the residues of oxidation). Residues are homogeneously spread all over the sample volume. Besides, Fig. 5 demonstrates that oxidation only affects the RL PyC matrix located in the open volume, *i.e.* the matrix covering the periphery of the yarns in the meso-scale pores and the one covering the fibers in the yarns in the micro-scale pores.

265

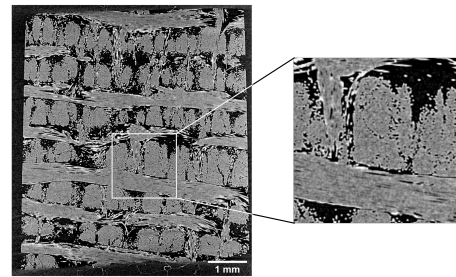

(a) Before test in  $O_2$  environment

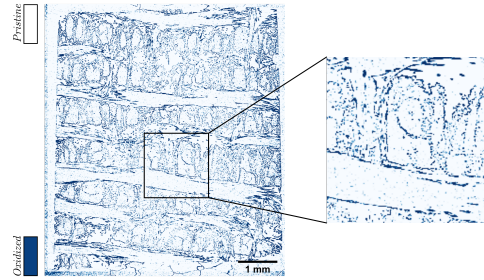

(b) Post-test residuals in  $O_2$  environment at 773K

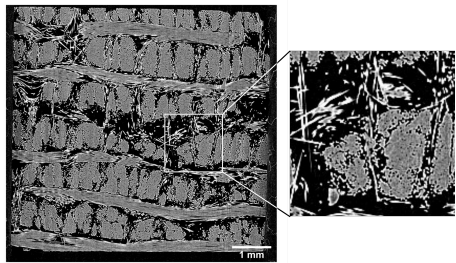

(c) Before test in  $H_2O$  environment

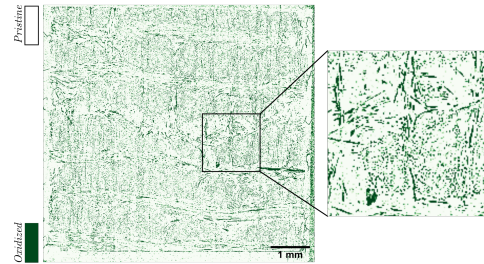

(d) Post-test residuals in  $H_2O$  environment at 1223K

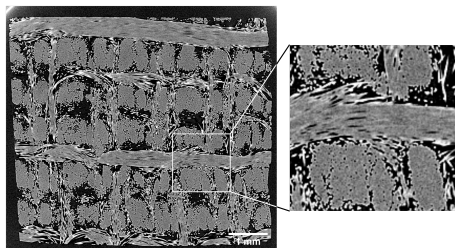

(e) Before test in  $CO_2$  environment

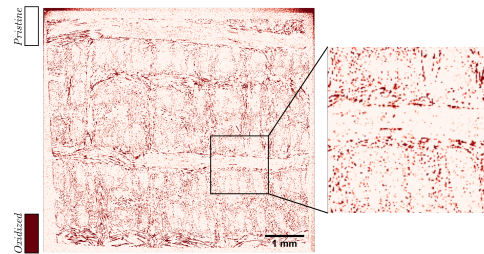

(f) Post-test residuals in  $CO_2$  environment at 1148K

FIGURE 5 – Core slices of  $\mu$ CT images of the samples (a, c, e) at a pristine stage, and of the oxidation residuals on processed  $\mu$ CT images in (b)  $O_2$ -, (d)  $H_2O$ - and (f)  $CO_2$ -containing atmospheres at various temperatures.

The analysis of the volumic samples topologies at the highest test temperatures reveals the same behavior at the lowest temperatures. Thus, for each of the oxidation atmospheres and test temperatures, the matrix is the most reactive phase

and seems to be affected by oxidation throughout the whole sample volume.

270 *3.3. Exploitation of the experimental oxidation activities*

Graphs from Fig. 6 display raw oxidation results of the samples burn-off defined by Eq. 4. One can note the neat increase of mass loss with temperature under each atmosphere and the different activation temperatures according to the oxidation species.

275

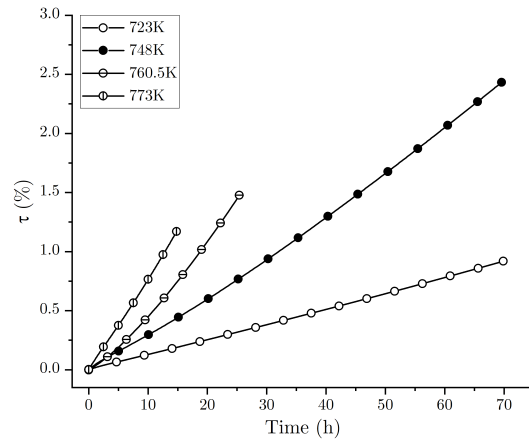

(a)  $O_2$  environment

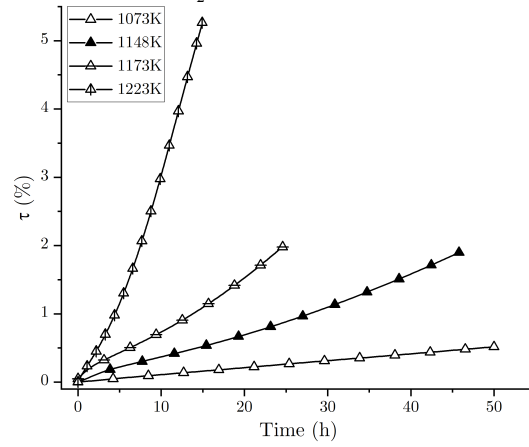

(b)  $H_2O$  environment

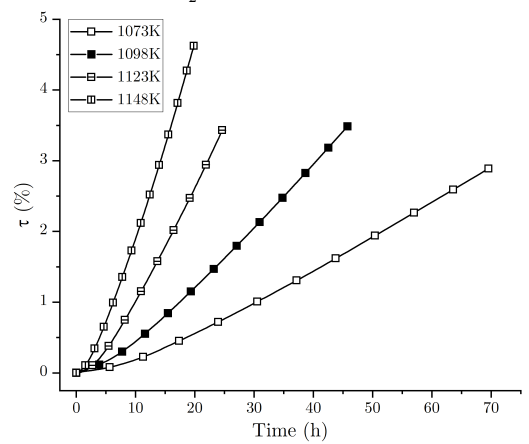

(c)  $CO_2$  environment

FIGURE 6 – Burn-off evolution with time and temperature under (a)  $O_2$ -, (b)  $H_2O$ - and (c)  $CO_2$ -containing atmospheres.

The logarithm of the oxidation rate constant  $k$  for each oxidizing atmosphere, computed from Eq. 7, is reported on the Arrhenius-type plot of Fig. 7. A simple linear fitting is achieved on the three sets of data. According to Eq. 8, intercepts and slopes of the fitting curves give pre-exponential factors and activation energies, respectively. For the RL PyC matrix the values and the associated correlation coefficient  $r_c$  are indexed in Table 2.

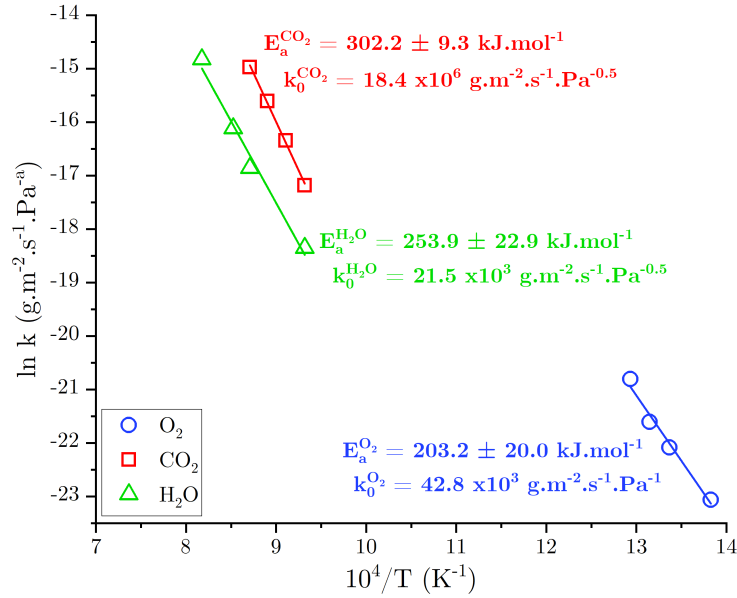

FIGURE 7 – Evolution of  $\ln k$  vs the inverse temperature in O<sub>2</sub>-, H<sub>2</sub>O- and CO<sub>2</sub>-containing atmospheres and associated linear fit.

Thus, from activation energies values, the following ascending classification of the RL PyC matrix oxidation resistance is made : O<sub>2</sub> < H<sub>2</sub>O < CO<sub>2</sub>. However, considering the oxidation reactivities from Fig. 7 and the pre-exponential factors in Table 7, the RL PyC matrix seems more reactive under CO<sub>2</sub> than under H<sub>2</sub>O.

Atmosphere	Temperature		$k_0$	$E_a$	$r_c$
		$K$	$g.m^{-2}.s^{-1}.Pa^{-a}$	$kJ.mol^{-1}$	-
$O_2/N_2$	20/80	723 - 773	$42.8 \times 10^3$	$203.2 \pm 20.0$	0.9810
$H_2O/N_2$	20/80	1073 - 1223	$21.5 \times 10^3$	$253.9 \pm 22.9$	0.9839
$CO_2/N_2$	20/80	1073 - 1148	$18.4 \times 10^6$	$302.2 \pm 9.3$	0.9981

TABLE 2 – Pre-exponential factors and activation energies for the RL PyC matrix under  $O_2$ ,  $H_2O$  and  $CO_2$  atmospheres and associated correlation coefficient.

### 3.4. Proof of evidence of an oxidation reaction in chemical regime

290 To properly determine kinetics, oxidation tests have to be carried out in the chemical regime, at the surface of the material and also in its porous volume, avoiding any limitation by diffusion [10]. Such a precaution ensures the proper identification of the true kinetic parameters related to the intrinsic oxidation mechanism. In this section, the existence of a chemical regime at the surface and  
295 inside the porous volume of the material will be demonstrated using experiments and modeling. This aims at proving that the oxidation kinetics identified in Section 3.3 are indeed associated to the intrinsic behavior of the RL PyC matrix.

#### 3.4.1. Chemical regime at the sample surface

The consumption ratio per geometrical surface unit  $\zeta$  for each oxidizing ex-  
300 periment has been computed from Eq. 9. Its evolution with temperature and the type of oxidizing atmosphere is reported on Fig. 8. One can note that the consumption of the oxidizing atmosphere logically increases with temperature, but remains under a cut-off threshold  $\zeta_{max}$  of  $4.6 \times 10^{-3} \text{ \%.mm}^{-2}$  for each experiment. The study of Zancanaro *et al.* [38] carried out on the same TGA equip-  
305 ment as in this study proved that the ratio between the number of carbon moles consumed and the amount of available oxidizing species has to remain under 1% in the close environment of the sample geometric surface to ensure an oxidation reaction in chemical regime, which is equivalent to  $\zeta_{max} = 4.6 \times 10^{-3} \text{ \%.mm}^{-2}$  for cubic samples of 6 mm edge length. Thus,  $\zeta$  values from Fig. 8 provide evidence

310 of an established chemical regime at the samples surfaces.

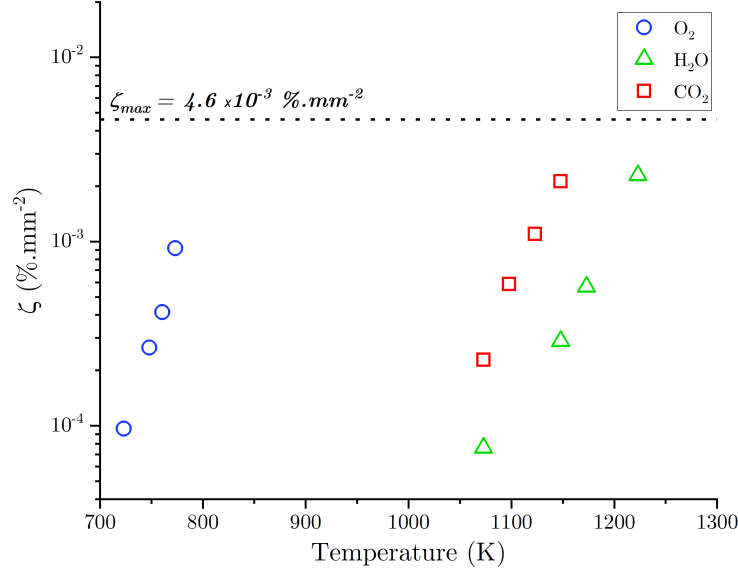

FIGURE 8 – Evolution of  $\zeta$  with temperature in O<sub>2</sub>-, H<sub>2</sub>O- and CO<sub>2</sub>-containing atmospheres.

### 3.4.2. Chemical regime in the sample volume

The experimental characterizations of the extent of oxidation throughout the porous volume in Section 3.2 have evidenced that the matrix covering the fibers, inside the yarns and at their periphery, is the dominant reacting phase and gets degraded uniformly no matter the depth inside the material.

This suggests that the chemical reaction rate is slower than the mass transport everywhere inside the porous medium. To confirm this, we provide computations of the Thiele modulus  $\Theta$  at each temperature and under each oxidizing atmosphere, which gives an estimation of the competition between reaction and diffusion in a porous medium. A value below 1 denotes a chemical reaction-controlled regime where the speed of the diffusion of the oxidation gas is faster than the oxidation reaction (*i.e.* low temperatures). A value above 1 is an indicator of limitations by diffusion the speed of the oxidation reaction is faster than diffusion (*i.e.* high temperatures). It has been extensively defined for fibrous architectures [15, 37, 55, 56] and is applicable to a highly porous C/C

composite as the one of this study, where the matrix is the only reacting phase, without loss of precision. It is defined as follows :

$$\Theta = L \sqrt{\frac{\sigma_v k_{het,m}}{D_{eff}}} \quad (10)$$

where  $L$  is the characteristic length of the material which is taken equal to  $3.10^{-3}$  m, *i.e.* the sample half-thickness, because it has been identified that oxidation took place through the whole bulk of the sample. The matrix heterogeneous reactivity  $k_{het,m}$  ( $m.s^{-1}$ ) is supposed to verify Eq. 8. The effective diffusion coefficient  $D_{eff}$  for an isotropic material of the type of the porous C/C composite of this study is defined as follows :

$$D_{eff} = D_0 \frac{\varepsilon^{1+\alpha}}{\eta} \quad (11)$$

where  $\varepsilon$  is the porosity of the C/C composite equal to 0.37,  $\eta$  is the tortuosity and  $\alpha$  is a diffusion parameter depending on the direction of the fibrous architecture. The values for these parameters for the C/C composite of this study are given in the work of Charles *et al.* [52]. For the present calculations, they are averaged values of the  $X$ ,  $Y$ , and  $Z$  directions and equal to 1.40 and 0.65 respectively. The binary diffusion coefficient  $D_0$  ( $m^2.s^{-1}$ ) of the oxidizing species in the gas mixture is computed from the recommended data from Massman [57] at each test temperature.

Fig. 9 sums up the Thiele modulus evolution with temperature for each oxidizing gas of this study. One can notice that  $\Theta$  values are neatly below 1 (even  $< 0.5$ ) for each of the oxidation tests. This confirms that a chemical reaction-controlled regime is reached everywhere in the porous volume. Besides, in addition to the SEM and 3D-image characterizations mentioned above, it also confirms that the oxidation reaction is homogeneous in the volume and only concerns the RL PyC matrix. This analysis strengthens the conclusion concerning the existence of a chemical reaction-controlled regime at the sample surface as well. Thus, oxidation kinetic parameters determined in Section 3.3 are proved to be intrinsic.



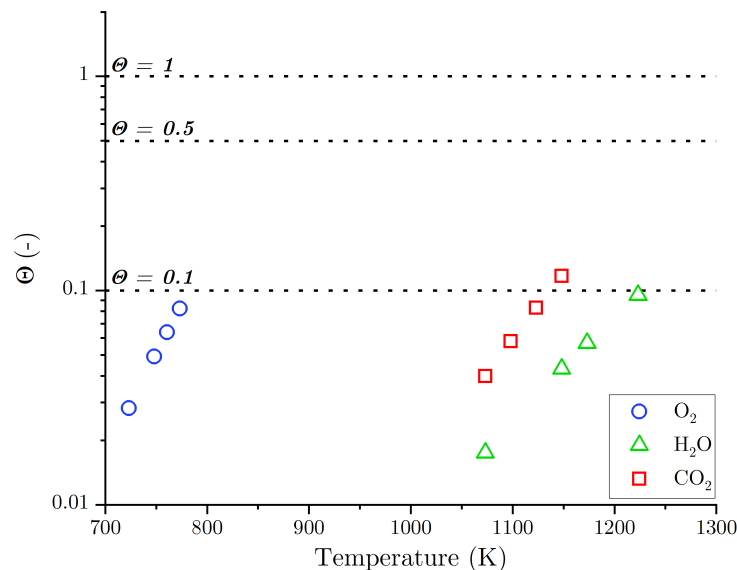

FIGURE 9 – Evolution of the Thiele modulus with temperature for the oxidation tests in the O<sub>2</sub>-, H<sub>2</sub>O- and CO<sub>2</sub>-containing atmospheres.

### 3.5. Comparisons with literature data

Table 3 contains a brief summary of activations energies from this study compared to various data from literature in O<sub>2</sub>, H<sub>2</sub>O and CO<sub>2</sub>-containing atmospheres collected on different types of carbonaceous materials. On the other hand, graphs from Fig. 10 allow visual comparison with some of the mentioned studies in Table 3, for which oxidation activities have been converted in the units and conditions of this study. These graphs are discussed in detail in the following sections.

#### 3.5.1. In O<sub>2</sub>-containing atmosphere

According to Fig. 10a, experimental oxidation data under dry air for the RL PyC matrix of this study are very well located among oxidation kinetics for other carbonaceous materials from other studies. In fact our data are well located within the bounds of Smith’s data collected on various types of carbons up to 1650K. On the other hand, up to approximately 1250K, the oxidation activity of the RL PyC matrix of this study is located below the values reported by

Luo *et al.* [18] for a so-called ex-CVD matrix. Up to 1650K it is also located below the values of Bertran *et al.* [21] obtained for an ex-resin matrix, and up to approximately 3300K it is below the one of Drawin *et al.* [17] obtained on an ex-pitch matrix. It also exceeds the oxidation reactivity of graphite particles reported by Bradley *et al.* [20] above approximately 820K. Ehrburger *et al.* [54] and Lahaye *et al.* [58] made a strong correlation between the amounts of carbon defects and of active sites and reactivity. Thus, considering that the pyrolytic structure of an RL PyC matrix prepared by CVI features a lesser amount of in-plane defects, than an ex-resin, ex-pitch or an ex-CVD matrix, as suggested by the results in Table 1, the matrix of this study is expected to be less reactive. Actually, Bertran *et al.* [21] determined a  $FWHM_D$  of  $133 \text{ cm}^{-1}$  for their ex-resin matrix, whereas the one for the RL PyC matrix of this study is  $97.8 \text{ cm}^{-1}$ , which denotes a lesser amount of in-plane defects. On the other hand, the RL PyC matrix structure might be less organized and display more in-plane defects than graphite particles, which explains the higher reactivity as compared to the data from Bradley *et al.* [20]. The relative value of the oxidation activity of the RL PyC matrix under dry air in comparison to other types of carbon on Fig. 10a is then in accordance with previous knowledge on the structure-reactivity relationship in dense carbons.

Ox. specie	Reference	$E_a$ $\text{kJ.mol}^{-1}$	Carbonaceous material
$\text{O}_2$	Luo <i>et al.</i> [18]	121	C/C with ex-CVD matrix
	Bertran <i>et al.</i> [21]	122	ex-resin matrix
	Chang and Rusnak [12]	146 - 181	ground ex-resin C/C
	McKee [59]	146 - 188	C/C with ex-pitch matrix
	Smith [16]	179.4	various
	Dacic and Marinkovic [35]	184	ex-CVD matrix
	Rossberg [27]	209 - 243	spectroscopic carbon
	<i>This study</i>	203.2	ex-CVI RL PyC matrix
$\text{H}_2\text{O}$	Qin <i>et al.</i> [22]	157.0	ex-pitch matrix
	Qin <i>et al.</i> [22]	234.0	ex-PAN fibers
	Libby and Blake [19]	175.3	carbon particles
	Bradley <i>et al.</i> [20]	287.9	graphite particles
	Rossberg [27]	334.7	spectroscopic carbon
	<i>This study</i>	253.9	ex-CVI RL PyC matrix
	$\text{CO}_2$	Ergun [26]	246.9
Bradley <i>et al.</i> [20]		284.9	graphite particles
Golovina <i>et al.</i> [23]		313.8	graphites at LT
Rossberg [27]		359.8	spectroscopic carbon
Shelef and Walker [60]		364	spectroscopic graphite
McKee <i>et al.</i> [24, 25]		386.3	isotropic carbon powder
<i>This study</i>		302.2	ex-CVI RL PyC matrix

TABLE 3 – Activation energy data of various carbonaceous material under  $\text{O}_2$ ,  $\text{H}_2\text{O}$  and  $\text{CO}_2$  oxidizing atmospheres from literature and this study. [*LT* meaning low temperatures.]

Regarding activation energies, a value of  $179.4 \text{ kJ.mol}^{-1}$  was found by Smith [16] for various carbonaceous materials under dry air, whereas one of  $122 \text{ kJ.mol}^{-1}$  for an ex-resin matrix was found by Bertran *et al.* [21] in dry air. Chang and  
370 Rusnak [12] and McKee [59] found quite the same range of activation energies of

146 to 181 kJ.mol for ground C/C composites filled with carbonaceous organic binders oxidized in dry air and 146 to 188 kJ.mol<sup>-1</sup> for C/C composites made of a carbonized ex-pitch matrix. On the other hand, Dacic and Marinkovic [35] and Luo *et al.* [18] identified activation energies of 184 kJ.mol<sup>-1</sup> and 121 kJ.mol<sup>-1</sup> for two different ex-CVD matrices. The value identified in this study of 203.2 kJ.mol<sup>-1</sup> rather matches with these data. These values are collected in Table 3.

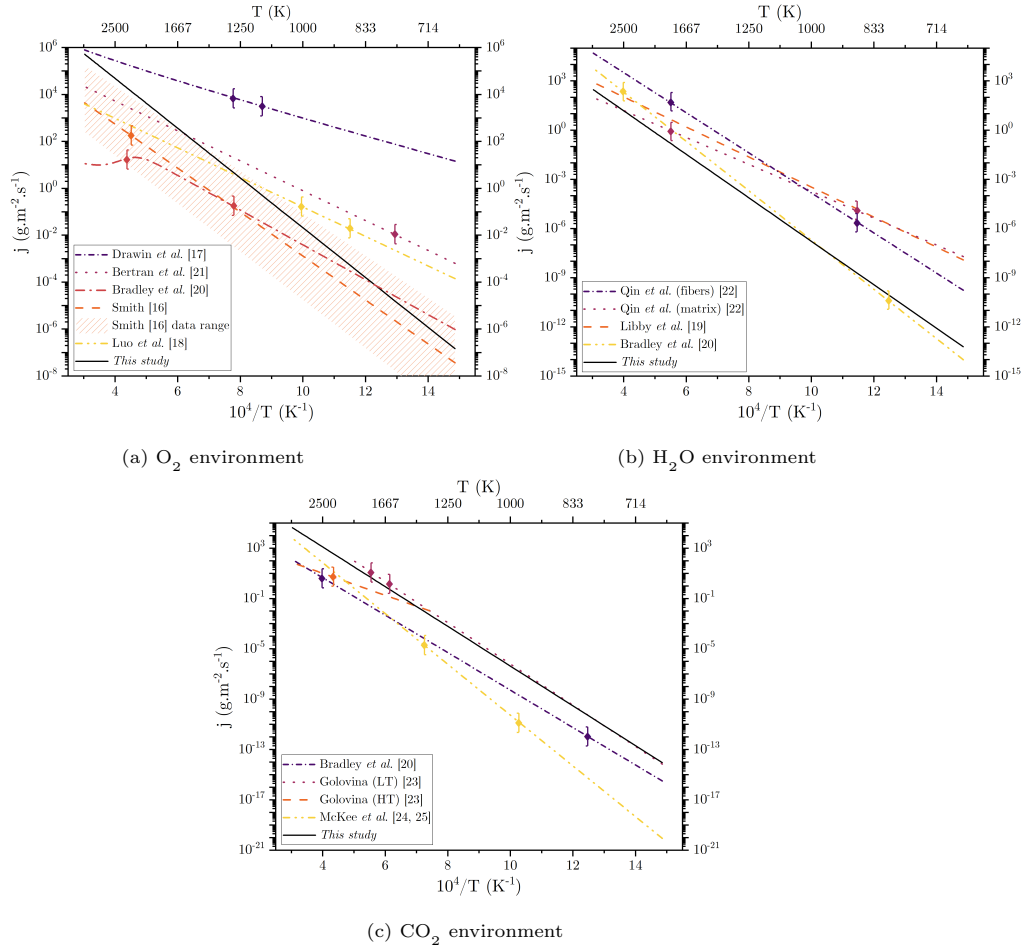

FIGURE 10 – Comparison with literature data of the present oxidation results for a RL PyC matrix under (a)  $\text{O}_2$ -, (b)  $\text{H}_2\text{O}$ - and (c)  $\text{CO}_2$ -containing [16, 17, 18, 19, 20, 21, 22, 23, 24, 25]. [*LT* meaning low temperatures; *HT* meaning high temperatures;  $\blacklozenge$  : bounds of the temperature domain.]

### 3.5.2. In $\text{H}_2\text{O}$ -containing atmosphere

Fig. 10b displays the oxidation activity identified for the RL PyC matrix in a water vapor atmosphere in comparison with other data from literature. The corresponding Arrhenius curve is located below the one of an ex-resin matrix from the work of Qin *et al.* [22] up to 2500K. As kinetic data under water vapor are scarce, a comparison with the oxidation evolution of the ex-PAN fibers from

the above-mentioned work is also proposed. The Arrhenius curve of the the  
385 RL PyC matrix of this work is still located below. This indicates its better  
oxidation resistance. A good match is noticed with the oxidation activity of  
graphite particles from the work of Bradley *et al.* [20] : the oxidation activity  
of the RL PyC matrix is located above up to 950K denoting a somewhat lesser  
oxidation resistance.

390 In term of activation energy, the value identified for the RL PyC matrix in this  
study, which is of  $253.9 \text{ kJ.mol}^{-1}$ , is consistent with the one from the study of  
Bradley *et al.* [20] of  $287.9 \text{ kJ.mol}^{-1}$  on graphite particles, as already witnessed  
for oxidation in  $\text{O}_2$ . It also fits the value of  $234 \text{ kJ.mol}^{-1}$  for the ex-PAN fibers  
from the work of Qin *et al.* [22]. On the other hand, this value is much higher  
395 than the one identified for the ex-pitch matrix of the above-mentioned study  
accounting for  $157 \text{ kJ.mol}^{-1}$  and also indicating a lower oxidation sensitivity of  
the RL PyC matrix compared to less organized carbonaceous materials. Finally,  
Table 3 summarizes these data for a convenient comparison.

### 3.5.3. In $\text{CO}_2$ -containing atmosphere

400 Similarly, the evolution of oxidation kinetics for the RL PyC matrix under  
a  $\text{CO}_2$ -containing atmosphere are in accordance with literature data as sugges-  
ted by Fig. 10c with a clear insertion among data from literature identified on  
different types of graphitic carbons. One can notice that there is an especially  
good match with the data from Golovina [23] on graphites at low temperatures.  
405 The evolution of the mass loss rate associated to the RL PyC is also located  
above the ones from the works of Bradley *et al.* [20] and McKee *et al.* [24, 25]  
on graphites, confirming its lower oxidation resistance compared to highly or-  
ganized materials.

Besides, the activation energy experimentally identified of  $302.2 \text{ kJ.mol}^{-1}$  is in  
410 line with the values of  $284.9$  and  $313.8 \text{ kJ.mol}^{-1}$  reported respectively by Bradley  
*et al.* [20] on graphite particles and Golovina [23] on graphites at low tempera-  
tures. McKee *et al.* [24, 25] determined a higher value of  $386.3 \text{ kJ.mol}^{-1}$  on iso-  
tropic carbon powders. Shelef and Walker [60] determined an activation energy

of  $364 \text{ kJ}\cdot\text{mol}^{-1}$  for a spectroscopic graphite under a purified carbon dioxide  
 415 atmosphere. On the other hand, Ergun [26] identified an activation energy of  
 $246.9 \text{ kJ}\cdot\text{mol}^{-1}$  on various activated carbon materials.

### 3.6. Wide-ranging comparison

Finally, Table 3 displays a global trend of oxidation resistance based on  
 activation energies between the three considered atmospheres which might be  
 420 summed up as follows :  $\text{O}_2 < \text{H}_2\text{O} < \text{CO}_2$ . In particular, the work of Rossberg  
 [27] that has established oxidation rate laws on the same carbonaceous material  
 for the three oxidizing atmospheres is consistent with this classification, as well  
 as the activation energies identified in this study for the RL PyC matrix.

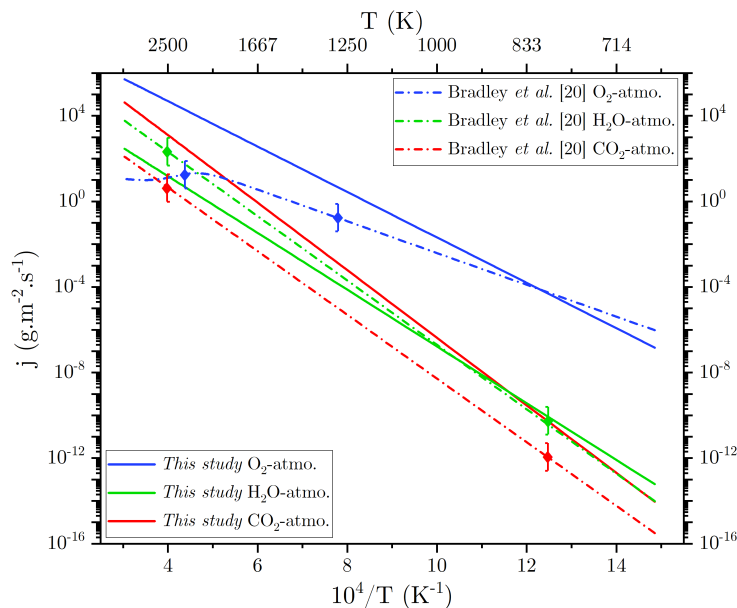

FIGURE 11 – Evolution of the oxidation activity for the graphite particles from Bradley *et al.* [20] and for the RL PyC matrix of this study under  $\text{O}_2$ -,  $\text{H}_2\text{O}$ - and  $\text{CO}_2$ -containing atmospheres. [ $\blacklozenge$  : bounds of the temperature domain.]

On the other hand, the higher resistance of the RL PyC matrix to H<sub>2</sub>O than to CO<sub>2</sub> in this study, based on the oxidation reactivity values, has been mentioned above, but is not the trend which is commonly witnessed in literature. Walker *et al.* [10] reported experimental works in which the mass loss of a graphitized carbon rod was 2.8 times higher at 1373K in a water vapor environment than in a carbon dioxide atmosphere. Graphite particles reported in the work of Bradley *et al.* [20] remain more oxidation resistant in a CO<sub>2</sub> environment than in an H<sub>2</sub>O atmosphere. Fig. 11 allows a visual comparison of all the data from this study in O<sub>2</sub>-, H<sub>2</sub>O- and CO<sub>2</sub>-containing atmospheres with the ones from the work of Bradley *et al.* [20]. From Fig. 11, it is clear that in fact the RL PyC matrix of this study is more oxidation resistant to H<sub>2</sub>O than to CO<sub>2</sub> up to approximately 870K considering the reaction oxidation activity.

From that point, the different trends observed in terms of oxidation reactivities and activation energies has to be contrasted.

First, activation energies cannot account by themselves for the overall oxidation behavior. The pre-exponential factor has to be considered as well. However, there is a great lack of information in literature for this parameter associated to the oxidation behavior of carbons under the considered atmospheres. This is the reason why the above classification based on activation energies is not representative of the reactivity for every type of carbon, but more importantly on a wide range of temperature. This is effectively demonstrated by Bradley *et al.* [20] on Fig. 11 : graphite particles become more resistant under O<sub>2</sub> than under CO<sub>2</sub> from 2120K whereas activation energies display an opposite behavior.

In the mean time, the nature of the oxidized carbonaceous material has to be considered. Data from Rossberg [27], Walker *et al.* [10] and Bradley *et al.* [20] were collected on spectroscopic carbons, graphitized carbons and graphite particles that are generally reported as highly organized and purified materials. The RL PyC matrix cannot be considered as such, considering its structure and texture features detailed in Section 3.1. Walker *et al.* [10] reported from different works that a retardation phenomenon under water vapor environment



caused by the chemisorption of hydrogen might happen. They also detailed that hydrogen chemisorption is strong and rapid, and is more likely to occur when the carbon surface displays heterogeneities, defects and impurities. That being  
460 said, the difference in the magnitude of oxidation reactivities under  $\text{H}_2\text{O}$  and  $\text{CO}_2$  observed for the RL PyC matrix compared to highly organized carbons from the above-mentioned studies might then be explained by this retardation phenomenon, interpreted as the population of some of the carbon active sites, instead of being oxidized by  $\text{H}_2\text{O}$ . The two main sources of chemisorbed hydro-  
465 gen atoms are : either a direct chemisorption of a hydrogen atom to a carbon site instead of forming  $\text{H}_{2(\text{g})}$  when  $\text{CO}_{(\text{g})}$  is released from the surface ; or the chemisorption of  $\text{H}_{2(\text{g})}$  coming from the gas phase after having been previously produced by  $\text{H}_2\text{O}$  reduction. Another side reaction reported by Walker *et al.* [10] is called the « water gas-shift reaction ». The reactant  $\text{H}_2\text{O}_{(\text{g})}$  may be consumed  
470 by the product  $\text{CO}_{(\text{g})}$  to form  $\text{CO}_{2(\text{g})}$  which reduces the  $\text{H}_2\text{O}_{(\text{g})}$  concentration in the close environment of the carbon surface. This side reaction is reported to be enhanced by the chemisorption of hydrogen atoms and by the nature of the carbonaceous material. Then, it can potentially contribute to invert the reaction magnitude ordering between  $\text{H}_2\text{O}$  and  $\text{CO}_2$ .

475 Finally, dissociation energies that have been cited before, and that follow the general trend of activation energies mentioned above, even for not highly organized materials, only account for the dissociation of an O-atom and a CO-molecule from the carbon surface. They do not include side reactions and for example the dissociation energy of the H-atom, which is also a product of the reaction of  
480 carbon with  $\text{H}_2\text{O}$  in the same molar proportion as CO according to Eq. 2. The cited dissociation energies are then insufficient to draw up a general classification of carbon oxidation resistance under the considered oxidizing environment.

#### 4. Conclusions

The intrinsic kinetics parameter of an RL PyC matrix under three different  
485 oxidizing atmospheres, *i.e.*  $\text{O}_2$ ,  $\text{H}_2\text{O}$  and  $\text{CO}_2$ , were identified throughout an

original method. A very porous C/C composite was considered, as the only way to study the oxidation behavior of a PyC material deposited by a CVI process on an ex-PAN fibrous architecture. The matrix has been proven to be the only reacting phase. The establishment of the oxidation reaction process in chemical regime at the surface and in the porous volume of the material, required  
490 to extract the intrinsic parameters of the matrix, was proven with the means of experimental characterizations and analytical modeling considerations. The identified kinetics values for the PyC material in question are brand new and are as follows : in  $O_2$  the associated  $E_a$  is of  $203.2 \text{ kJ.mol}^{-1}$  and  $k_0$  is equal  
495 to  $42.8 \times 10^3 \text{ g.m}^{-2}.\text{s}^{-1}.\text{Pa}^{-1}$ ; in  $H_2O$ ,  $E_a = 253.9 \text{ kJ.mol}^{-1}$  and  $k_0 = 21.5 \times 10^3 \text{ g.m}^{-2}.\text{s}^{-1}.\text{Pa}^{-0.5}$ ; and under  $CO_2$ ,  $E_a = 302.2 \text{ kJ.mol}^{-1}$  and  $k_0 = 18.4 \times 10^6 \text{ g.m}^{-2}.\text{s}^{-1}.\text{Pa}^{-0.5}$ . Comparisons with literature data collected over different types of carbonaceous materials were discussed and attested from the veracity and consistency of the results.

500 Similar experiments could be run on other types of pyrocarbons (regenerative laminar (ReL), smooth laminar (SL), isotropic (I)) in order to identify kinetic parameters related to their peculiar pyrolytic structure. On the other hand, reaction partial orders have been assumed so far. The identification of their actual values throughout similar experiments under different oxidizing species  
505 partial pressures could be an outlook of this work.

### Acknowledgments

The authors wish to thank ArianeGroup SAS that have financially supported this work throughout a PhD grant to Marina Fradin. Olivier Caty (Bordeaux INP, LCTS) is warmly acknowledged for helping in 3D-images acquisition. X-ray  $\mu$ CT scans were acquired at the *Placamat* characterization service unit of  
510 Bordeaux University and CNRS.

## Nomenclature

Symbol	Meaning	Unit(s)
<b>Greek symbols</b>		
$L$	Characteristic length of the material	m
$\alpha$	Diffusion parameter (Eq. 11)	-
$\eta$	Tortuosity	-
$\tau$	Burn-off	%
$\dot{\tau}$	Burn-off rate	%. $s^{-1}$
$\Theta$	Thiele modulus	-
$\sigma_v$	Effective surface area	$m^{-1}$
$\zeta$	Consumption ratio per geometrical surface unit	%. $mm^{-2}$
<b>Latin symbols</b>		
$a$	Reaction partial order	-
$A_e$	Extinction angle	$^\circ$
$D_0$	Binary diffusion coefficient	$m^2.s^{-1}$
$D_{eff}$	Effective diffusion coefficient	$m^2.s^{-1}$
$E_a$	Activation energy	$J.mol^{-1}$
$FWHM_D$	Full Width at Half Maximum of the D-band	$cm^{-1}$
$FWHM_G$	Half Width at Half Maximum of the G-band	$cm^{-1}$
$I_D/I_G$	Intensity ratio of the D- and G-bands	-
$j$	Oxidation activity	$g.m^{-2}.s^{-1}$
$k$	Oxidation reactivity	$g.m^{-2}.s^{-1}.Pa^{-a}$
$k_{het,m}$	Matrix heterogeneous reactivity	$m.s^{-1}$
$k_0$	Pre-exponential factor	$g.m^{-2}.s^{-1}.Pa^{-a}$
$L_a$	In-plane coherence length	nm
$m$	Mass	g
$n_C^{cons}$	Consumed carbon moles	mol
$n_{ox}^{cons}$	Available oxygen moles	mol
$P_{ox}$	Partial pressure	atm
$\mathcal{R}$	Universal ideal gas constant	$J.mol^{-1}.K^{-1}$
$r_c$	Correlation coefficient	-
$S_{geo}$	Geometrical surface	$mm^2$
$S_{vol}$	Internal surface	$m^2$
$t$	Time	s
$T$	Temperature	K
$V_{geo}$	Geometrical volume	$m^3$
<b>Subscripts and superscripts</b>		
0	Relative to initial state	-
$i$	Relative to the instant $i$	-

## Data availability

515 The raw data required to reproduce these findings cannot be shared at this  
time due to legal reasons. The processed data required to reproduce these find-  
ings cannot be shared at this time due to legal reasons.

## References

- 520 [1] R. Naslain, F. Langlais, R. Fedou, The CVI-processing of ceramic matrix  
composites, *Journal de Physique Colloques* 50 (C5) (1989) C5–191–C5–207.  
[doi:10.1051/jphyscol:1989526](https://doi.org/10.1051/jphyscol:1989526).
- [2] N. P. Padture, Advanced structural ceramics in aerospace propulsion, *Nature Materials* 15 (8) (2016) 804–809. [doi:10.1038/nmat4687](https://doi.org/10.1038/nmat4687).
- 525 [3] E. Fitzer, L. M. Manocha, *Carbon Reinforcements and Carbon/Carbon Composites*, Springer, 1998. [doi:10.1007/978-3-642-58745-0](https://doi.org/10.1007/978-3-642-58745-0).
- [4] X. Jin, X. Fan, C. Lu, T. Wang, Advances in oxidation and ablation resis-  
tance of high and ultra-high temperature ceramics modified or coated car-  
bon/carbon composites, *Journal of the European Ceramic Society* 38 (1)  
530 (2018) 1–28. [doi:10.1016/j.jeurceramsoc.2017.08.013](https://doi.org/10.1016/j.jeurceramsoc.2017.08.013).
- [5] C. Zweben, Chapter 10 - Composite Materials, in : M. Kutz (Ed.), *Mechanical Engineers' Handbook*, 4th Edition, 2015, pp. 1–37. [doi:https://doi.org/10.1002/9781118985960.meh110](https://doi.org/10.1002/9781118985960.meh110).
- [6] P. Morgan, *Carbon fibers and their composites*, 1st Edition, Taylor and  
535 Francis, Boca Raton, FL, 2005. [doi:10.1007/978-94-017-9478-7\\_5](https://doi.org/10.1007/978-94-017-9478-7_5).
- [7] V. Borie, Y. Maisonneuve, D. Lambert, G. Lengellé, Ablation des matériaux  
de tuyères de propulseurs à propergol solide, Technical report 13, ISSN-  
0078-3781 (1990).
- [8] G. Duffa, *Ablative Thermal Protection Systems Modeling*, AIAA Educa-  
540 tion Series, 2013. [doi:10.2514/4.101717](https://doi.org/10.2514/4.101717).

- [9] G. L. Vignoles, J. Lachaud, Y. Aspa, Environmental Effects : Ablation of C/C Materials-Surface Dynamics and Effective Reactivity, in : Ceramic Matrix Composites, John Wiley & Sons, Inc., Hoboken, NJ, USA, 2014, Ch. 12, pp. 353–388. doi:10.1002/9781118832998.ch12.
- 545 [10] P. L. Walker, F. Rusinko, L. G. Austin, Gas reactions of carbon, Advances in Catalysis Volume 11 (1959) 133–221. doi:https://doi.org/10.1016/S0360-0564(08)60418-6.
- [11] E. Duivivier, Cinétique d’oxydation d’un composite Carbone/Carbone et influence sur le comportement mécanique, Ph.D. thesis, Bordeaux (1997).  
550 URL <https://www.theses.fr/1997B0R10539>
- [12] H.-W. Chang, R. M. Rusnak, Oxidation behavior of carbon-carbon composites, Carbon 17 (5) (1979) 407–410. doi:10.1016/0008-6223(79)90056-3.
- [13] S. Kumar, J. Kushwaha, S. Mondal, A. Kumar, R. K. Jain, G. Rohini Devi,  
555 Fabrication and ablation testing of 4D C/C composite at 10MW/m<sup>2</sup> heat flux under a plasma arc heater, Materials Science and Engineering A 566 (2013) 102–111. doi:10.1016/j.msea.2012.12.059.
- [14] J. Lachaud, Y. Aspa, G. L. Vignoles, Analytical modeling of the steady state ablation of a 3D C/C composite, International Journal of Heat and Mass Transfer 51 (9-10) (2008) 2614–2627. doi:10.1016/j.ijheatmasstransfer.2008.01.008.  
560
- [15] G. L. Vignoles, A. Turchi, D. Bianchi, P. Blaineau, X. Lamboley, D. Le Quang Huy, et al., Ablative and catalytic behavior of carbon-based porous thermal protection materials in nitrogen plasmas, Carbon 134 (2018) 376–  
565 390. doi:10.1016/j.carbon.2018.03.087.
- [16] I. W. Smith, The intrinsic reactivity of carbons to oxygen, Fuel (1978). doi:10.1016/0016-2361(78)90055-8.

- [17] S. Drawin, M. Bacos, J. Dorvaux, Oxidation Model for Carbon-Carbon Composites, *AIAA Journal* AIAA-92-50 (1992) 0–9. doi:10.2514/6.1992-5016.
- 570
- [18] R. Luo, J. Cheng, T. Wang, Oxidation behavior and protection of carbon/carbon composites prepared using rapid directional diffused CVI techniques, *Carbon* 40 (11) (2002) 1965–1972. doi:10.1016/S0008-6223(02)00025-8.
- [19] P. A. Libby, T. R. Blake, Burning carbon particles in the presence of water vapor, *Combustion and Flame* 41 (C) (1981) 123–147. doi:10.1016/0010-2180(81)90047-X.
- 575
- [20] D. Bradley, G. Dixon-Lewis, S. El-din Habik, E. M. Mushi, The oxidation of graphite powder in flame reaction zones, *Symposium (International) on Combustion* 20 (1) (1984) 931–940. doi:10.1016/S0082-0784(85)80582-8.
- 580
- [21] X. Bertran, G. Chollon, J. Dentzer, R. Gadiou, S. Fouquet, M. A. Dourges, et al., Oxidation behavior at moderate temperature under dry and wet air of phenolic resin-derived carbon, *Thermochimica Acta* 649 (2017) 13–21. doi:10.1016/j.tca.2016.12.013.
- 585
- [22] F. Qin, L. Na Peng, G. Qiang He, J. Li, Y. Yan, Oxidation kinetics and mechanisms of carbon/carbon composites and their components in water vapour at high temperatures, *Corrosion Science* 90 (2015) 340–346. doi:10.1016/j.corsci.2014.10.027.
- [23] E. Golovina, The gasification of carbon by carbon dioxide at high temperatures and pressures, *Carbon* 18 (3) (1980) 197–201. doi:https://doi.org/10.1016/0008-6223(80)90061-5.
- 590
- [24] D. W. McKee, Catalytic effects of alkaline earth carbonates in the carbon-carbon dioxide reaction, *Fuel* 59 (5) (1980) 308–314. doi:https://doi.org/10.1016/0016-2361(80)90215-X.
- 595

- [25] D. McKee, Gasification of graphite in carbon dioxide and water vapor—the catalytic effects of alkali metal salts, *Carbon* 20 (1) (1982) 59–66. doi: [https://doi.org/10.1016/0008-6223\(82\)90075-6](https://doi.org/10.1016/0008-6223(82)90075-6).
- [26] S. Ergun, Kinetics of the reaction of carbon with carbon dioxide, *The Journal of Physical Chemistry* 60 (4) (1956) 480–485. doi:10.1021/j150538a022.
- [27] M. Rossberg, Experimentelle Ergebnisse über die Primärreaktionen bei der Kohlenstoffverbrennung, *Zeitschrift für Elektrochemie, Berichte der Bunsengesellschaft für physikalische Chemie* 60 (9-10) (1956) 952–956.  
URL <http://onlinelibrary.wiley.com/doi/10.1002/bbpc.19560600905/abstract>
- [28] S. R. Kelemen, H. Freund, A comparison of O<sub>2</sub> and CO<sub>2</sub> oxidation of glassy carbon surfaces, *Carbon* 23 (6) (1985) 723–729. doi:10.1016/0008-6223(85)90234-9.
- [29] O. Karlström, A. Brink, M. Hupa, Desorption kinetics of CO in char oxidation and gasification in O<sub>2</sub>, CO<sub>2</sub> and H<sub>2</sub>O, *Combustion and Flame* 162 (3) (2015) 788–796. doi:10.1016/j.combustflame.2014.08.010.
- [30] I. Golecki, Rapid vapor-phase densification of refractory composites, *Materials Science and Engineering : R : Reports* 20 (2) (1997) 37–124, r20. doi:[https://doi.org/10.1016/S0927-796X\(97\)00003-X](https://doi.org/10.1016/S0927-796X(97)00003-X).
- [31] D. Kopeliovich, 5 - Advances in manufacture of ceramic matrix composites by infiltration techniques, in : I. Low (Ed.), *Advances in Ceramic Matrix Composites, second edition Edition*, Woodhead Publishing Series in Composites Science and Engineering, Woodhead Publishing, 2018, pp. 93–119. doi:<https://doi.org/10.1016/B978-0-08-102166-8.00005-0>.
- [32] Y. Xu, *Chemical Vapour Infiltration*, Springer London, London, 2010, pp. 165–213. doi:10.1007/978-1-84882-894-0\_5.

- [33] F. Langlais, G. Vignoles, 5.4 chemical vapor infiltration processing of ceramic matrix composites, in : P. W. Beaumont, C. H. Zweben (Eds.),  
625 Comprehensive Composite Materials II, Elsevier, Oxford, 2018, pp. 86–129.  
doi:<https://doi.org/10.1016/B978-0-12-803581-8.03912-6>.
- [34] G. Vignoles, 8 - Chemical Vapor Deposition/Infiltration Processes for Ceramic Composites, in : P. Boisse (Ed.), Advances in Composites Manufacturing and Process Design, Woodhead Publishing, 2015, pp. 147–176.  
630 doi:<https://doi.org/10.1016/B978-1-78242-307-2.00008-7>.
- [35] B. Dačić, S. Marinković, Kinetics of air oxidation of unidirectional carbon fibres/ CVD carbon composites, Carbon 25 (3) (1987) 409–415. doi:10.1016/0008-6223(87)90012-1.
- [36] K. Z. Li, X. T. Shen, H. J. Li, S. Y. Zhang, T. Feng, L. L. Zhang, Ablation of  
635 the carbon/carbon composite nozzle-throats in a small solid rocket motor,  
Carbon 49 (4) (2011) 1208–1215. doi:10.1016/j.carbon.2010.11.037.
- [37] J. C. Ferguson, F. Panerai, J. Lachaud, A. Martin, S. C. Bailey, N. N. Mansour, Modeling the oxidation of low-density carbon fiber material based on micro-tomography, Carbon 96 (2016) 57–65. doi:10.1016/j.carbon.2015.08.113.  
640
- [38] M. Zancanaro, N. Bertrand, F. Rebillat, Definition of Optimized Conditions to Extract Accurate Kinetic Laws from TGA Experiments : Modeling and Validation, Oxidation of Metals 87 (3-4) (2017) 393–402. doi:10.1007/s11085-017-9716-6.
- [39] F. Panerai, T. Cochell, A. Martin, J. D. White, Experimental measurements of the high-temperature oxidation of carbon fibers, International Journal of Heat and Mass Transfer 136 (2019) 972–986. doi:10.1016/j.ijheatmasstransfer.2019.03.018.  
645
- [40] A. Lacombe, M. Lacoste, T. Pichon, 3D Novoltex® and Naxeco® carbon-carbon nozzle extensions; matured, industrial and available technologies  
650



to reduce programmatic and technical risks and to increase performance of launcher upper stage engines, 44th AIAA/ASME/SAE/ASEE Joint Propulsion Conference and Exhibit (July) (2008) 1–10. doi:10.2514/6.2008-5236.

- 655 [41] A. Lacombe, T. Pichon, J. M. Amouroux, HERAKLES thermal-  
structural composite materials boost rocket nozzle performance, 49th  
AIAA/ASME/SAE/ASEE Joint Propulsion Conference 1 PartF (July)  
(2013). doi:10.2514/6.2013-3863.
- [42] E. Frank, L. M. Steudle, D. Ingildeev, J. M. Spörl, M. R. Buchmeiser,  
660 Carbon fibers : Precursor systems, processing, structure, and properties,  
Angewandte Chemie - International Edition 53 (21) (2014) 5262–5298. doi:  
10.1002/anie.201306129.
- [43] C. Charles, Relations entre la structure de milieux fibreux et leurs pro-  
priétés thermiques et de transfert de masse, Ph.D. thesis, Université de  
665 Bordeaux (2022).  
URL <https://www.theses.fr/2021BORD0322>
- [44] A. P. Gillard, G. Couégnat, O. Caty, A. Allemand, P. Weisbecker, G. L.  
Vignoles, A quantitative, space-resolved method for optical anisotropy es-  
timation in bulk carbons, Carbon 91 (2015) 423–435. doi:10.1016/j.  
670 carbon.2015.05.005.
- [45] P. Lespade, A. Marchand, M. Couzi, F. Cruège, Caractérisation de  
matériaux carbonés par microspectrométrie Raman, Carbon 22 (4-5) (1984)  
375–385. doi:10.1016/0008-6223(84)90009-5.
- [46] J. M. Vallerot, X. Bourrat, A. Mouchon, G. Chollon, Quantitative structur-  
675 al and textural assessment of laminar pyrocarbons through Raman spec-  
troscopy, electron diffraction and few other techniques, Carbon 44 (9)  
(2006) 1833–1844. doi:10.1016/j.carbon.2005.12.029.

- [47] G. L. Vignoles, P. Weisbecker, J.-M. Leyssale, S. Jouannigot, G. Chollon, Carbones pyrolytiques ou pyrocarbones : des matériaux multiéchelles et multiperformances, *Techniques de l'ingénieur* 33 (2015). doi:10.51257/a-v1-nm3150.
- [48] P. Mallet-Ladeira, P. Puech, C. Toulouse, M. Cazayous, N. Ratel-Ramond, P. Weisbecker, et al., A Raman study to obtain crystallite size of carbon materials : A better alternative to the Tuinstra-Koenig law, *Carbon* 80 (1) (2014) 629–639. doi:10.1016/j.carbon.2014.09.006.
- [49] J. R. Arthur, Reactions between carbon and oxygen, *Transactions of the Faraday Society* 47 (1950) 164–178. doi:10.1039/tf9514700164.
- [50] J. M. Calo, M. T. Perkins, A heterogeneous surface model for the "steady-state" kinetics of the Boudouard reaction, *Carbon* 26 (3) (1987) 395–407.
- [51] J. Schindelin, I. Arganda-Carreras, E. Frise, V. Kaynig, M. Longair, T. Pietzsch, et al., Fiji : An open-source platform for biological-image analysis, *Nature methods* 9 (2012) 676–82. doi:10.1038/nmeth.2019.
- [52] C. Charles, C. Descamps, G. L. Vignoles, Low pressure gas transfer in fibrous media with progressive infiltration : correlation between different transfer modes, *International Journal of Heat and Mass Transfer* 182 (2022) 121954. doi:10.1016/j.ijheatmasstransfer.2021.121954.
- [53] G. Dupupet, Fibres de carbone, *Techniques de l'ingénieur* TIB625. (am5134) (2008) 19. doi:10.51257/a-v1-am5134.
- [54] P. Ehrburger, F. Louys, J. Lahaye, The concept of active sites applied to the study of carbon reactivity, *Carbon* 27 (3) (1989) 389–393. doi:10.1016/0008-6223(89)90071-7.
- [55] F. Panerai, A. Martin, N. N. Mansour, S. A. Sepka, J. Lachaud, Flow-tube oxidation experiments on the carbon preform of a phenolic-impregnated carbon ablator, *Journal of Thermophysics and Heat Transfer* 28 (2) (2014) 181–190. doi:10.2514/1.T4265.

- [56] J. Lachaud, N. Bertrand, G. L. Vignoles, G. Bourget, F. Rebillat, P. Weisbecker, A theoretical/experimental approach to the intrinsic oxidation reactivities of C/C composites and of their components, *Carbon* 45 (14) (2007) 2768–2776. doi:10.1016/j.carbon.2007.09.034.
- 710 [57] W. J. Massman, A review of the molecular diffusivities of H<sub>2</sub>O, CO<sub>2</sub>, CH<sub>4</sub>, CO, O<sub>3</sub>, SO<sub>2</sub>, NH<sub>3</sub>, N<sub>2</sub>O, NO, and NO<sub>2</sub> in air, O<sub>2</sub> and N<sub>2</sub> near STP, *Atmospheric Environment* 32 (6) (1998) 1111–1127. doi:10.1016/S1352-2310(97)00391-9.
- 715 [58] J. Lahaye, F. Louys, P. Ehrburger, The reactivity of carbon-carbon composites, *Carbon* 28 (1) (1990) 137–141. doi:10.1016/0008-6223(90)90104-7.
- [59] D. W. McKee, Oxidation behavior and protection of carbon/carbon composites, *Carbon* 25 (4) (1987) 551–557. doi:10.1016/0008-6223(87)90197-7.
- 720 [60] M. Shelef, P. Walker, Transient phenomena in the gasification of graphite by high-purity carbon dioxide, *Carbon* 5 (2) (1967) 93–105. doi:https://doi.org/10.1016/0008-6223(67)90063-2.