



HAL
open science

Condition for periodic attractor in 4-dimensional repressilators

Honglu Sun, Maxime Folschette, Morgan Magnin

► **To cite this version:**

Honglu Sun, Maxime Folschette, Morgan Magnin. Condition for periodic attractor in 4-dimensional repressilators. 21st International Conference on Computational Methods in Systems Biology (CMSB 2023), Sep 2023, Luxembourg City, Luxembourg. pp.184-201, 10.1007/978-3-031-42697-1_13. hal-04135182

HAL Id: hal-04135182

<https://hal.science/hal-04135182>

Submitted on 20 Jun 2023

HAL is a multi-disciplinary open access archive for the deposit and dissemination of scientific research documents, whether they are published or not. The documents may come from teaching and research institutions in France or abroad, or from public or private research centers.

L'archive ouverte pluridisciplinaire **HAL**, est destinée au dépôt et à la diffusion de documents scientifiques de niveau recherche, publiés ou non, émanant des établissements d'enseignement et de recherche français ou étrangers, des laboratoires publics ou privés.



Distributed under a Creative Commons Attribution 4.0 International License

Condition for periodic attractor in 4-dimensional repressilators^{*}

Honglu Sun¹[0000–0002–8265–0984], Maxime Folschette²[0000–0002–3727–2320], and Morgan Magnin¹[0000–0001–5443–0506]

¹ Nantes Université, École Centrale Nantes, CNRS, LS2N, UMR 6004, F-44000 Nantes, France — *Corresponding author: honglu.sun@ls2n.fr*

² Univ. Lille, CNRS, Centrale Lille, UMR 9189 CRIStAL, F-59000 Lille, France

Abstract. One of the key questions about gene regulatory networks is how to predict complex dynamical properties based on the influence graph’s topology. Earlier theoretical studies have identified conditions for complex dynamical properties, like multistability or oscillations, based on topological features, like the presence of a positive (negative) feedback loop. This work follows this path and aims to find a sufficient and necessary condition for the existence of a periodic attractor in 4-dimensional (4 genes) repressilators based on a discrete modeling framework under some dynamical assumptions. These networks are extensions of the widely studied 3-dimensional repressilator, which has been used in synthetic biology to produce synthetic oscillations. While other researchers have explored specific extensions of the 3-dimensional repressilator to improve synthetic oscillation control, our work investigates all 4-dimensional networks with only inhibitions. By uncovering new insights about periodic attractors in these small networks, our findings could aid the design of new synthetic oscillations. We search for condition for period attractor in an exhaustive manner with the guide of a decision tree model. Our major contributions include: 1) discovering that, with one exception, the relations between gene regulation thresholds do not impact the existence of periodic attractors in any of the influence graphs considered in this study; 2) identifying a sufficient and necessary condition of simple form for the existence of a periodic attractor when the exception is ignored; 3) identifying new topological features of influence graphs that are necessary for predicting the existence of periodic attractor in 4-dimensional repressilators.

Keywords: Periodic attractor · Discrete dynamical system · Repressilator · Decision tree · Gene regulatory networks.

1 Introduction

Gene expression is not an isolated biological process as the expression of a single gene could activate or inhibit the expression of one or multiple other genes. These

^{*} Supported by China Scholarship Council.

complex interdependencies among genes constitute the gene regulatory network, which is always represented mathematically as a directed graph known as the influence graph. The vertices in the influence graph correspond to individual genes, while the arcs denote the relations between genes.

Our work focuses on a fundamental question about gene regulatory networks: how can we predict a system’s dynamical properties from its influence graph? In fact, the dynamical properties do not only depend on the topology of the influence graph, but also depend on the dynamical model used to model the gene regulatory network. In the literature, different modeling frameworks have been applied to model gene regulatory networks, mainly continuous models [3, 4, 13], discrete models [14, 32, 33, 15, 6, 7] and hybrid models [5, 10, 31, 9]. This work is based on Thomas’ discrete modeling framework of gene regulatory networks [32, 33], where the continuous expression values of all genes in the system are abstracted by a vector of integers, called discrete state, describing the discrete expression levels of all genes, and the system’s dynamics are then captured by the transitions between discrete states. Using this discrete modeling framework, we can describe the dynamical properties of the system in terms of the existence of different attractors. There are two types of attractors: fixed-point attractors, which correspond to stable states, and periodic attractors, which correspond to oscillations. One major advantage of using discrete modeling is its simplicity in implementation and analysis.

Our study investigates all 4-dimensional (with 4 genes) gene regulatory networks with only inhibition relations, called 4-dimensional repressilators, as they can be considered extensions of the 3-dimensional canonical repressilator. The 3-dimensional canonical repressilator is a network of three genes having a unique feedback loop with only inhibitions between genes [30, 11, 8, 23]. It is widely studied in synthetic biology due to its ability to generate synthetic oscillations. However, controlling these synthetic oscillations remains an open problem. To address this issue, there are works studying extensions of 3-dimensional canonical repressilator by adding more genes into the network [19, 22, 12, 34, 35]. Most of these works focus on some specific networks and are mostly based on ordinary differential equations. In our work, we use discrete dynamical models to study all possible combinations of 4-dimensional networks with only inhibitions, under some dynamical assumptions. Our goal is to identify a sufficient and necessary condition for the existence of a periodic attractor. The existence of a periodic attractor in discrete models is linked to the presence of oscillations in certain hybrid models, which is significant from the perspective of synthetic biology as sometimes the goal is to have synthetic oscillations.

The method to find such conditions for a periodic attractor has two major steps. Firstly, we exhaustively generate all discrete models of 4-dimensional repressilators and compute various topological features of their influence graphs. Using these features we construct a highly accurate machine learning model which predicts the existence of periodic attractor with an accuracy close to 1.0. Secondly, we manually analyze this machine learning model to develop a sufficient and necessary condition for periodic attractor. In fact, the idea of studying

certain classes of networks in an exhaustive manner has been used in the literature [17, 16, 24] but, as far as we know, it has not yet been applied specifically to 4-dimensional repressilators.

It is worth noting that some theoretical works have investigated the relationship between the dynamical properties of discrete models and the topological structures of influence graphs [21, 28, 27, 25, 29]. Specifically, these studies have employed topological characteristics such as the presence of positive or negative feedback loops in the influence graph to describe conditions that lead to the emergence of complex dynamical properties, such as multistability, oscillations or attractors. In line with these studies, we also adopt topological features to develop the desired condition. Furthermore, we have identified new features that are essential for predicting the existence of a periodic attractor in 4-dimensional repressilators.

We also want to highlight that the machine learning-based approach used in this work for exhaustively searching for conditions could be potentially extended for the search of conditions that determine various properties in other systems.

We summarize the main contributions of this work as follows:

- We show that with the exception of one particular influence graph, the relations between the thresholds of gene regulations have no impact on the existence of a periodic attractor; in other words, the existence of a periodic attractor is solely dependent on the topology of the influence graph.
- We introduce new features, namely *total out-degree of cycles of length n* , which characterize the influence graph’s topology and are essential to describe the condition for the existence of a periodic attractor in 4-dimensional repressilators.
- Based on these new features, we find a new sufficient and necessary condition for the existence of a periodic attractor in 4-dimensional repressilators, except for the aforementioned particular influence graph.

The paper is organized as follows. In Section 2, we introduce the discrete modeling framework used in this work. In Section 3, we present the 4-dimensional repressilators and some dynamical assumptions used in this work. In Section 4, we represent step by step how we develop a sufficient and necessary condition for periodic attractor. Finally, in Section 5, we make a conclusion and discuss our future works.

2 Discrete modeling of gene regulatory networks

This section introduces the pre-existing discrete modeling of *gene regulatory networks* used in this work. A gene regulatory network can be described by a directed graph $IG = (V, A)$ called *influence graph*, where V is the set of vertices describing the genes in the system and A is the set of arcs describing the regulations (activation or inhibition) between genes. For example, Fig 1-Left represents an influence graph of a 3-dimensional gene regulatory network. In this gene regulatory network, the expression of gene G_0 (resp. G_1) activates the

expression of gene G_1 (resp. G_2) (the sign “+” on the arc denotes an activation) and the expression of G_0 inhibits the expression of G_2 (the sign “-” on the arc denotes an inhibition).

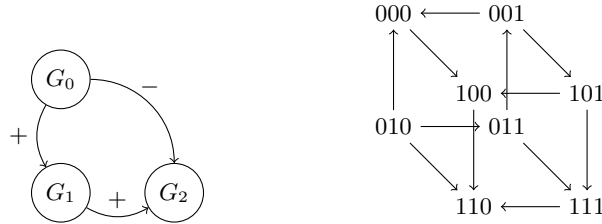

Fig. 1. Left: a 3-dimensional influence graph. Right: a transition graph of discrete states, based on the influence graph on the left and the logic program of Eq. 3.

An influence graph can only describe partially a gene regulatory network, as it lacks the description of some dynamical properties. In this work, we use a discrete modeling framework of gene regulatory networks. In this discrete modeling framework, the continuous expression of a gene is abstracted by an integer (e.g. 0, 1, 2, ...), called discrete level, which describes the discrete expression level of a gene. More formally, for any gene $G \in V$, there exists a set of integers $a(G)$ which gives all possible discrete levels of G ; for instance, if G has only two discrete levels, then $a(G) = \{0, 1\}$. A discrete model is a logic program which is a set of logic rules. The form of a logic rule is shown as follows:

$$G_i = k \leftarrow \phi_i \quad (1)$$

where $G_i \in V$ is a gene in the system, $k \in a(G_i)$ is a possible discrete level of G_i , and ϕ_i is a logic formula. The form of a logic formula ϕ is given as follows:

$$\phi ::= \emptyset \mid G \sim k \mid \phi_1 \wedge \phi_2 \mid \phi_1 \vee \phi_2 \quad (2)$$

where $k \in a(G)$ is a possible discrete level of gene G , \sim is one of the relations $\{>, <, =, \geq, \leq\}$, ϕ_1 and ϕ_2 are also logic formulas.

A logic rule (see Eq 1) indicates that if ϕ_i at discrete time t (t is an integer) is satisfied, then at time $t+1$ the value of G_i can be updated to k . For example, a possible discrete model of the influence graph in Fig 1-Left is given as follows:

$$\begin{aligned} G_0 &= 1 \leftarrow \emptyset \\ G_1 &= 1 \leftarrow (G_0 = 1) \\ G_1 &= 0 \leftarrow (G_0 = 0) \\ G_2 &= 1 \leftarrow (G_0 = 0) \wedge (G_1 = 1) \\ G_2 &= 0 \leftarrow (G_0 = 1) \vee (G_1 = 0) \end{aligned} \quad (3)$$

In this example, the second line indicates that, if at time t the discrete level of G_0 is 1, then at time $t+1$ the discrete level of G_1 can be updated to 1; this

logic rule corresponds to the activation from G_0 to G_1 in the influence graph. The first line indicates that for any moment t , the discrete level of G_0 can be updated to 1 at time $t + 1$ (in fact, once the discrete level of G_0 reaches 1, it will remain at 1).

The simulation of a discrete model is not solely dependent on these logic rules, but also relies on the semantics of the model. Intuitively, the semantics dictates the number of genes that can be updated simultaneously. Various semantics, such as synchronous, asynchronous, general and most permissive, have been proposed in the literature [26, 20]. In this work, we adopt the asynchronous semantics, meaning that the discrete level of only one gene is updated at a time. The asynchronous semantics is formally defined as follows.

We consider a system with N genes noted as G_1, G_2, \dots, G_N . We define that a discrete state d_s of a system is an integer vector of length N , which assigns the discrete level d_s^i to gene G_i , where $i \in \{1, 2, 3, \dots, N\}$ and d_s^i is the i^{th} component of d_s . For any discrete state d_s at time t , if there exists a logic rule $G_{i_0} = k \leftarrow \phi$ where $i_0 \in \{1, 2, 3, \dots, N\}$, such that d_s satisfies ϕ (meaning that the assignment $G_i = d_s^i$ for $i \in \{1, 2, 3, \dots, N\}$ satisfies ϕ) and $d_s^{i_0} \neq k$, then at time $t + 1$, the system can reach the new discrete state d'_s such that $d'_s = d_s$ for $i \in \{1, 2, 3, \dots, N\} \setminus \{i_0\}$ and $d'^{i_0} = k$.

Based on the choice of semantics, we can get the transition graph of discrete states of a discrete model, which is a directed graph containing all possible transitions between discrete states from t to $t + 1$. The transition graph of discrete states describes the dynamics of a discrete model. Note that depending on the semantics, the dynamics can be non-deterministic, as is the case for the asynchronous semantics. For example, Fig 1-Right presents the transition graph of discrete states, derived by asynchronous semantics, of the discrete model described by the logic program in Eq 3. Consider the discrete state 101 (representing the assignment $G_0 = 1, G_1 = 0, G_2 = 1$), according to the logic program in Eq 3, G_1 can be updated from 0 to 1 and G_2 can be updated from 1 to 0. Since we use asynchronous semantics, only one gene can be updated, so it can reach 100 or 111, but it cannot make two updates at the same time to reach 110.

3 4-dimensional repressilator

The scope of this work is limited to 4-dimensional gene regulatory networks where genes are linked only through inhibition, and where every gene has an impact on at least one other gene. In fact, the 3-dimensional network with a unique negative feedback loop with only inhibitions, called canonical repressilator, has been proved in the literature to be able to generate oscillations, while the understanding of oscillations in its 4-dimensional extensions is still limited. We call these networks 4-dimensional repressilators. An influence graph of such networks is shown in Fig 2.

Our analysis of these 4-dimensional repressilators is based on two underlying assumptions about their dynamics.

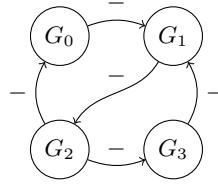

Fig. 2. An influence graph of a 4-dimensional repressilator.

Assumption 1 *If one gene influences m different genes, then it has m distinct thresholds that correspond to each of these m genes.*

Consider the influence graph of Fig 2, G_2 inhibits G_0 and G_3 , so G_2 has two distinct thresholds because of Assumption 1, meaning that it has three discrete levels: 0, 1, 2. Since other genes only influence one other gene, they only have two discrete levels: 0, 1. A similar assumption can be found in [1] for example.

The relations between the two thresholds of G_2 can have impact on the dynamical properties of the system. To show the relations between thresholds on an influence graph, we introduce the notion of influence graph with thresholds which is defined as $IGS = (V, A, s)$ where V and A are the sets of genes and regulations between genes respectively, as in the definition of an influence graph, and the function s assigns an integer to each regulation that represents the minimum discrete level of the source gene necessary to inhibit the target gene. Thus, the function s also characterizes the relationship between thresholds.

From the influence graph of Fig 2, by considering all different relations between thresholds, we can get two different influence graphs with thresholds as illustrated in Fig 3. For the regulation $G_2 \rightarrow G_3$ in the left influence graph with thresholds, $s(G_2 \rightarrow G_3) = 2$ (which is the number on the arc) means that G_3 is inhibited by G_2 if the discrete level of G_2 is bigger or equal to 2. For the regulation $G_2 \rightarrow G_0$ in the same graph, $s(G_2 \rightarrow G_0) = 1$ means that G_0 is inhibited by G_2 if the discrete level of G_2 is bigger or equal to 1. We can see that, in the left influence graph with thresholds, the threshold of G_2 triggering the inhibition of G_0 is smaller than the threshold triggering the inhibition of G_3 , while in the right influence graph with thresholds, the situation is reversed. We can also see that the function s gives all possible discrete levels of the system.

A priori, different discrete models (logic programs) can be associated to the same influence graph with thresholds, particularly when one gene is inhibited by several genes. Moreover, different choices of logic programs lead to different transition graphs, in other words different dynamical properties. In this work, we make an assumption about the dynamics when one gene is inhibited by several genes.

Assumption 2 *In an influence graph with threshold $IGS = (V, A, s)$, for any gene G , its discrete level can decrease by 1 if there exists a regulation from G' to G and the current discrete level of G' is bigger or equal to $s(G' \rightarrow G)$, otherwise its discrete level can increase by 1.*

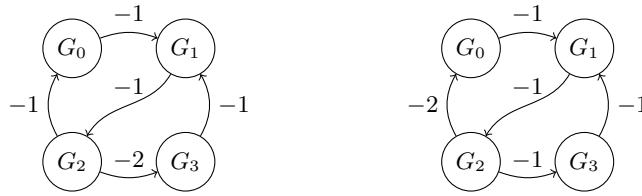

Fig. 3. Different influence graphs with thresholds corresponding to the influence graph of Fig 2.

In fact, Assumption 2 is equivalent to assume that the inhibitions are disjunctive, meaning that only one inhibitor is enough to decrease the target gene. Similar assumptions about the disjunction or conjunction of gene regulation can be found in [18, 2]. Consider the influence graph with thresholds on the left of Fig 3; Assumption 2 leads to the following logic program:

$$\begin{aligned}
 G_0 = 0 &\leftarrow (G_2 \geq 1) \\
 G_0 = 1 &\leftarrow (G_2 < 1) \\
 G_1 = 0 &\leftarrow (G_0 \geq 1) \vee (G_3 \geq 1) \\
 G_1 = 1 &\leftarrow (G_0 < 1) \wedge (G_3 < 1) \\
 G_2 = 0 &\leftarrow (G_1 \geq 1) \wedge (G_2 \leq 1) \\
 G_2 = 1 &\leftarrow (G_1 \geq 1) \wedge (G_2 = 2) \\
 G_2 = 1 &\leftarrow (G_1 < 1) \wedge (G_2 = 0) \\
 G_2 = 2 &\leftarrow (G_1 < 1) \wedge (G_2 \geq 1) \\
 G_3 = 0 &\leftarrow (G_2 \geq 2) \\
 G_3 = 1 &\leftarrow (G_2 < 2)
 \end{aligned} \tag{4}$$

Note that, for instance, there needs to be two rules in order to make G_2 increase to the expression level 2: one to update it from level 0 to level 1 (line 7) and one to make it increase from 1 to 2 (line 8); this is because we didn't constraint the dynamics to be unitary and we thus need to encode this property inside the rules. Using Assumption 2, we get a unique discrete model from any influence graph with thresholds, which simplifies the analysis. The transition graph of discrete states corresponding to the discrete model of Eq 4 is illustrated in Fig 4.

The general logic rules for an arbitrary *IGS* are given in Eq 5.

$$\begin{aligned}
 G_i = k + 1 &\leftarrow (G_i = k) \wedge (k < \text{Max}(a(G_i))) \wedge (\forall G \in \text{reg}(G_i), G < s(G \rightarrow G_i)) \\
 G_i = k - 1 &\leftarrow (G_i = k) \wedge (k > 0) \wedge (\exists G \in \text{reg}(G_i), G \geq s(G \rightarrow G_i))
 \end{aligned} \tag{5}$$

where $\text{Max}(a(G_i))$ is the maximum discrete level of G_i and $\text{reg}(G_i)$ is the set of all genes that inhibit G_i . Obviously, the rules of Eq 4 can be derived from the ones of Eq 5 by simplification. Some simplifications also involve the knowledge of the dynamics given in Section 2.

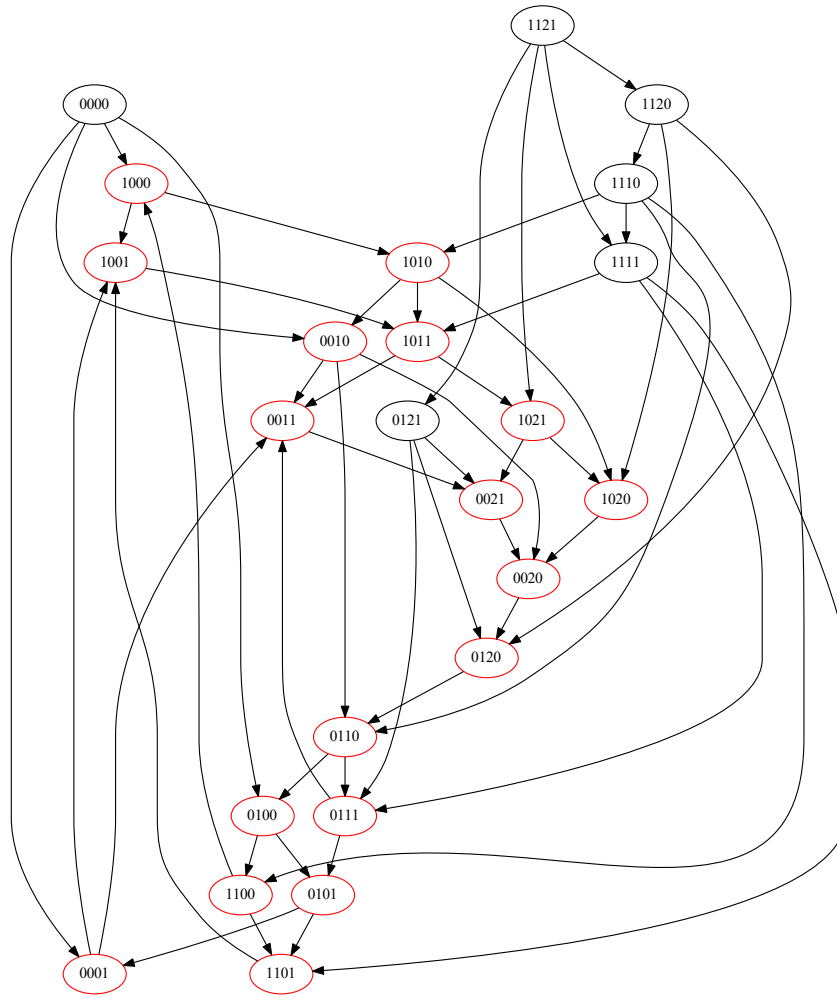

Fig. 4. Transition graph of discrete states of a model of 4-dimensional repressilator (corresponding to Eq 4). Red discrete states represent a periodic attractor.

4 Condition for a periodic attractor

In this section, we present our contribution: a step by step method to find a sufficient and necessary condition for the existence of a periodic attractor in 4-dimensional repressilators. Additionally, we also discuss the number of oscillatory dimensions in these periodic attractors. The definition of a periodic attractor is given as follows.

Definition 1. *A periodic attractor is a set of discrete states E_a such that:*

- E_a contains at least two discrete states.
- For any two discrete states $d_s, d'_s \in E_a$, there exists a path in the transition graph of discrete states from d_s to d'_s .
- For any discrete state $d_s \in E_a$ and for any discrete state $d'_s \notin E_a$, there is no path in the transition graph of discrete states from d_s to d'_s .

One example of periodic attractor is given by the red discrete states in Fig 4.

4.1 Feature selection and search of candidate condition based on decision tree

In order to find such condition, we firstly construct a decision tree model following the five steps below. The reason why we want to construct a decision tree model is that if we could obtain a decision tree with a classification accuracy of 1.0 to predict the existence of a periodic attractor, then this decision tree is equivalent to a sufficient and necessary condition for this periodic attractor in 4-dimensional repressilators. This work indeed only considers a finite number of discrete models, and a decision tree can be intuitively explained.

1. Generate all influence graphs with thresholds of 4-dimensional repressilators.
2. For each influence graph with thresholds, check the existence of a periodic attractor using an attractor identification algorithm. Here, an influence graph having a periodic attractor means that the associated discrete model (which is unique because of Assumption 2) has a periodic attractor.
3. Compute manually some features which could be potentially used to predict the existence of a periodic attractor.
4. Construct a decision tree model which uses the features in the previous step to predict the existence of a periodic attractor.
5. Manually drop some features which do not influence the prediction result.

In step 1, there are 50625 influence graphs with thresholds in total without removing the graphs that are equivalent.

In step 2, we use the function *attracting_components* of the Python library NetworkX to verify the existence of a periodic attractor. We find that any influence graph with thresholds which has a periodic attractor has only one periodic attractor.

In step 3, we compute two classes of features on the influence graph to describe the topology of the influence graph: the *number of cycles of length n* and the *total out-degree of cycles of length n* .

For the first class, since the system has 4 genes, there are only cycles of length 2, 3 and 4. We use $C2$, $C3$ and $C4$ to represent the numbers of cycles of length 2, 3 and 4, respectively. For example, for the influence graph in Fig 2, there is no cycle of length 2 or 4 ($C2 = 0, C4 = 0$) and two cycles of length 3 ($C3 = 2$). It is logical to use these features to predict the existence of a periodic attractor because, in this class of repressilators, the length of a cycle determines whether it is a negative feedback loop or a positive feedback loop as there is only inhibition regulations and the presence of loops is related to the existence of attractor(s). For example, it is already known that the presence of a negative feedback loop is a necessary condition for sustained oscillations [27] and the presence of positive feedback loop is a necessary condition for multistability [28].

The second class of features is a new class of features introduced in this work which is defined formally as follows.

Definition 2 (Total out-degree of cycles of length n). *The total out-degree of cycles of length n is the total number of arcs which go from a vertex which belongs to a cycle of length n to a vertex which does not belong to this cycle.*

For example, for the influence graph in Fig 2, the arc $G_2 \rightarrow G_3$ goes from the cycle of length 3: $G_0 \rightarrow G_1 \rightarrow G_2$, to G_3 , which does not belong to this cycle. There are two arcs like this in this influence graph: $G_2 \rightarrow G_3$ (for the cycle $G_0 \rightarrow G_1 \rightarrow G_2$) and $G_2 \rightarrow G_0$ (for the cycle $G_1 \rightarrow G_2 \rightarrow G_3$). So the total out-degree of cycles of length 3 is 2. Since, in this influence graph, there is no cycle of length 2, the total out-degree of cycles of length 2 is 0. Since the graph considered in this work has only 4 genes, the total out-degree of cycles of length 4 is always 0. We use $OD2$ and $OD3$ to denote the total out-degree of cycles of length 2 and 3, respectively.

To explain the motivation about these features describing the total out-degree of cycles, let's consider the two influence graphs in Fig 5. The dynamical properties of these two influence graphs are different: any influence graph with thresholds associated to the left influence graph has a periodic attractor while any influence graph with threshold associated to the right influence graph does not have a periodic attractor. However, the topologies of these two influence graphs are similar: the numbers of cycles of length 2, 3 and 4 of these two graphs are identical and they both have 6 arcs. In order to find a condition for periodic attractor, we need to find a way to exhibit the topological difference between these two graphs, and these new features are effective: for the left graph, $OD2 = 1, OD3 = 3$; for the right one, $OD2 = 2, OD3 = 2$. Note that these features do not depend on the relations between thresholds.

In step 4, we construct a decision tree to predict the existence of a periodic attractor based on the 5 features $C2$, $C3$, $C4$, $OD2$ and $OD3$ using all influence graphs with thresholds considered in this work. This decision tree is constructed automatically using the decision tree model of the Python library Scikit-learn.

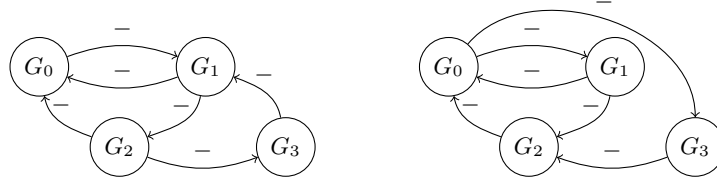

Fig. 5. Left: influence graph always having a periodic attractor. Right: influence graph never having a periodic attractor.

The accuracy of prediction of this decision tree is nearly 0.9990. Initially, we wished this accuracy to be 1 because in that case, the decision tree would provide a sufficient and necessary condition for the existence of a periodic attractor. This small lack of accuracy is actually caused by a few influence graphs with thresholds all related to the same influence graph. By analyzing this influence graph, a very interesting result arises:

There exists one particular influence graph such that, for any influence graph with thresholds that is not associated to this influence graph (or any isomorphism), the existence of a periodic attractor does not depend on the relations between thresholds and can be predicted by this decision tree with an accuracy of 1.

This particular influence graph is shown in Fig 6. This figure also presents all influence graphs with thresholds, associated to this influence graph, having a periodic attractor. In fact, with the exception of the relation between the thresholds presented in this figure (the only arcs assigned with numbers), the relations between the thresholds of G_2 do not influence the existence of a periodic attractor, meaning that for any order of thresholds of G_2 added to this figure, it always has a periodic attractor.

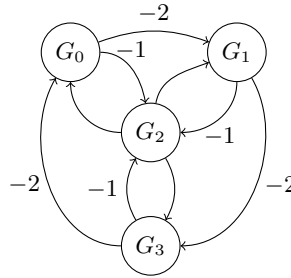

Fig. 6. The particular influence graph whose the relations between thresholds influence the existence of a periodic attractor. Amongst all influence graphs with thresholds associated to this influence graph, only a subset has a periodic attractor; this subset is characterized by the thresholds depicted in the figure.

In step 5, we manually drop features that do not influence the accuracy of the decision tree model. To do so, we re-train the decision tree each time after dropping one feature and observing if the accuracy decreases. Finally, we find that only keeping the features $OD2$ and $OD3$ ensures the same accuracy. We have also verified that this is the only couple of features that can maintain this accuracy. The final decision tree is shown in Fig 7. In this tree, the blue leaves predict the existence of a periodic attractor, and the other leaves predict the non-existence of a periodic attractor. We can see that except the second leaf from the right, models in all other leaves are classified correctly. In fact, this second leaf from the right contains all models associated to the particular influence graph of Fig 6. This means that apart from this particular influence graph, this tree describes a sufficient and necessary condition for the existence of a periodic attractor in 4-dimensional repressilators.

4.2 Condition simplification

In this subsection, we compute a simplified sufficient and necessary condition for the existence of a periodic attractor based on the decision tree of Fig 7. The four paths which end at blue leaves, which are the leaves related to the existence of a periodic attractor, are equivalent to the following logic rules:

$$\begin{aligned}
& (OD2 \leq 4 \wedge OD3 \leq 4 \wedge OD2 \leq 1 \wedge OD3 \leq 2 \wedge OD3 > 1 \wedge OD2 \leq 0) \vee \\
& \quad (OD2 \leq 4 \wedge OD3 \leq 4 \wedge OD2 \leq 1 \wedge OD3 > 2) \vee \\
& (OD2 \leq 4 \wedge OD3 \leq 4 \wedge OD2 > 1 \wedge OD2 \leq 2 \wedge OD3 > 3) \vee \\
& \quad (OD2 \leq 4 \wedge OD3 > 4)
\end{aligned} \tag{6}$$

Since $OD2$ and $OD3$ are integers, these logic rules can be simplified as follows.

$$\begin{aligned}
& (OD2 = 0 \wedge OD3 = 2) \vee \\
& (OD2 \in \{0, 1\} \wedge OD3 \in \{3, 4\}) \vee \\
& (OD2 = 2 \wedge OD3 = 4) \vee \\
& (OD2 \in \{0, 1, 2, 3, 4\} \wedge OD3 \in \{5, 6, 7, \dots\})
\end{aligned} \tag{7}$$

Moreover, for all influence graphs, $OD2$ and $OD3$ are not independent and they are linked by the following constraints. Since there is a finite number of models, these constraints can be easily obtained by enumerating all models and comparing the values of $OD2$ and $OD3$.

$$\begin{aligned}
& \text{If } OD2 = 0 \text{ then } OD3 \in \{0, 1, 2, 3\} \\
& \text{If } OD2 = 1 \text{ then } OD3 \in \{0, 1, 2, 3, 4\} \\
& \text{If } OD2 = 2 \text{ then } OD3 \in \{0, 1, 2, 3, 4, 5\} \\
& \text{If } OD2 = 3 \text{ then } OD3 \in \{0, 1, 2, 3\} \\
& \text{If } OD2 = 4 \text{ then } OD3 \in \{0, 1, 2, 3, 4, 6, 8\}
\end{aligned} \tag{8}$$

By combining Eq 7 and Eq 8, we get the following result, which is a sufficient and necessary condition for the existence of a periodic attractor in case that the

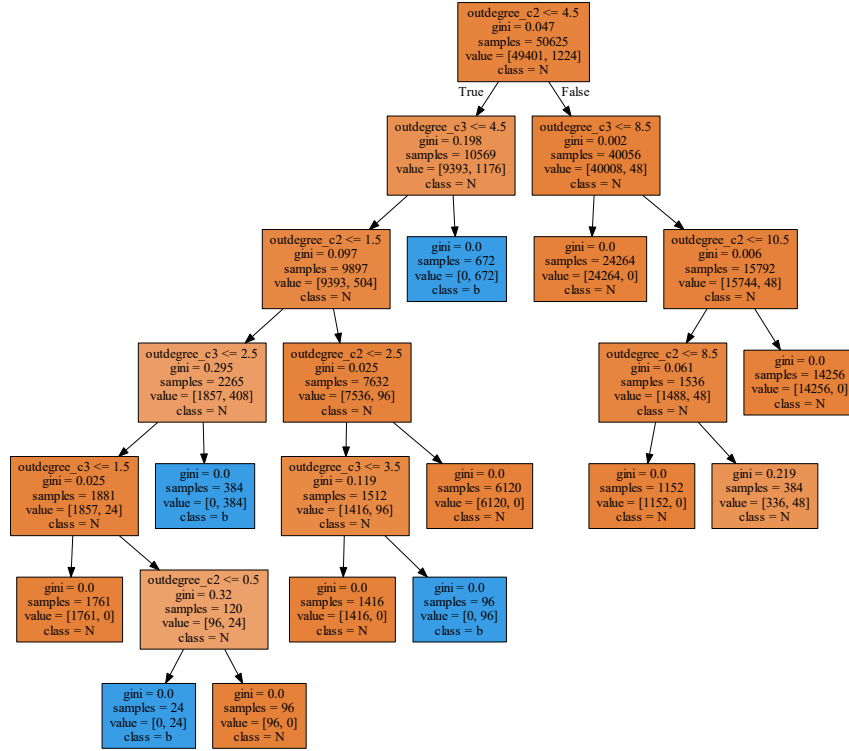

Fig. 7. A decision tree model to predict the existence of a periodic attractor. Blue leaves represent the models classified as having a periodic attractor and orange leaves represent the models classified as not having a periodic attractor. “gini” describes the purity of models in a node regarding the two classes considered here: models having a periodic attractor and models not having a periodic attractor; if all models in a node belong to the same class then $\text{gini} = 0$, otherwise $\text{gini} > 0$ ($\text{gini} = 1 - (\frac{\text{number}_{class1}}{\text{number}_{total}})^2 - (\frac{\text{number}_{class2}}{\text{number}_{total}})^2$). “sample” represents the number of models in a node. The first value of “value” represents the number of models not having a periodic attractor and the second value of “value” represents the number of models having a periodic attractor.

influence graph is not equivalent to the one in Fig 6:

$$\begin{aligned}
& (OD2 = 0 \wedge OD3 \in \{2, 3\}) \vee \\
& (OD2 = 1 \wedge OD3 \in \{3, 4\}) \vee \\
& (OD2 = 2 \wedge OD3 \in \{4, 5\}) \vee \\
& (OD2 = 4 \wedge OD3 \in \{6, 8\})
\end{aligned} \tag{9}$$

This result is of simple form and we can also find some patterns in it: the values of $OD2$ are powers of 2 ($2^0, 2^1, 2^2$) except 0, and $OD3$ increases as $OD2$ increases. These patterns might lead to some general theoretical results for N-dimensional repressilators.

4.3 Number of oscillatory dimensions in a periodic attractor

In this subsection, we also investigate the number of oscillatory dimensions in the periodic attractors. For a periodic attractor, oscillating in 3 dimensions means that there exists one dimension i_0 and an integer a such that for any discrete state d_s in this periodic attractor, $d_s^{i_0} = a$, and for any dimension i which differs from i_0 , we can find two discrete states d_{s1}, d_{s2} in this periodic attractor, such that $d_{s1}^i \neq d_{s2}^i$. An example of a periodic attractor that oscillates in 3 dimensions is given in Fig 8 where there is no oscillation in the first dimension. Oscillating in 4 dimensions means that for any dimension i , we can find two discrete states d_{s1}, d_{s2} in this periodic attractor, such that $d_{s1}^i \neq d_{s2}^i$. For example, the periodic attractor in Fig 4 oscillates in 4 dimensions.

By automatically verifying the isomorphisms of all influence graphs with periodic attractors except the influence graph of Fig 6, we find that there are, in total, only 8 different (non-isomorphic) influence graphs which always have periodic attractors. Any influence graph with thresholds corresponding to these 8 influence graphs has only one periodic attractor. Among these 8 influence graphs, 2 of them (Fig 9) can have periodic attractors which oscillate in both 3 and 4 dimensions depending on different relations between thresholds, and the other 6 (Fig 10) only have periodic attractors which oscillate in 4 dimensions.

5 Conclusion

In this work, we study the condition for the existence of a periodic attractor in 4-dimensional repressilators under some dynamical assumptions. With the guide of decision tree models, we find a special influence graph for which the relations between thresholds influence the existence of a periodic attractor. For all other influence graphs, we show that the existence of a periodic attractor does not depend on the relations between thresholds and we find a sufficient and necessary condition with a simple form, describing the topology of the influence graph, for the existence of a periodic attractor.

In this work, we use an exhaustive and computational approach to find this condition and we find some patterns in this condition. In our next step, we would

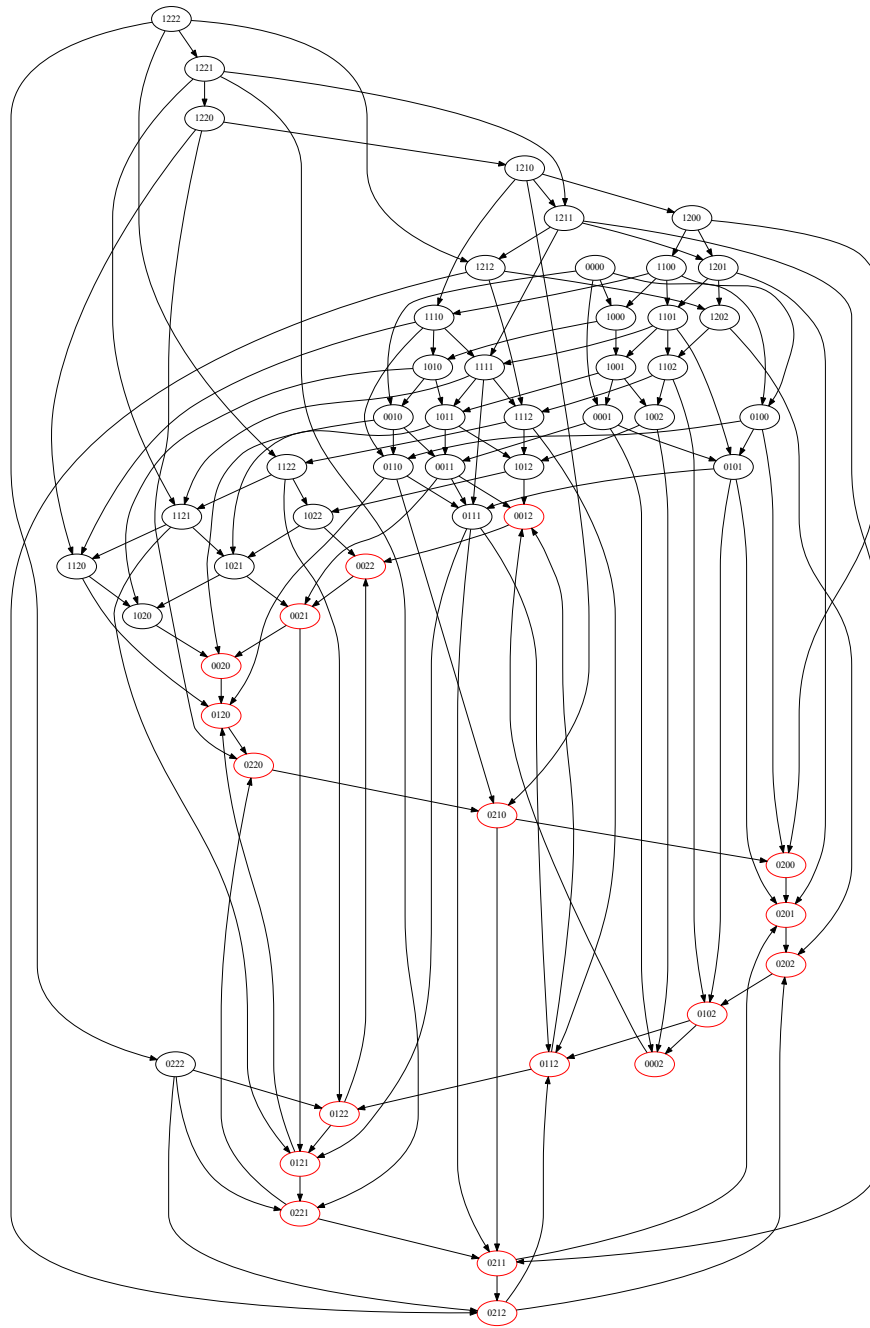

Fig. 8. Example of a periodic attractor (red discrete states) that oscillates in 3 dimensions. The discrete model corresponds to the left influence graph in Fig 9, with $s(G_1 \rightarrow G_0) = s(G_2 \rightarrow G_0) = s(G_3 \rightarrow G_0) = 1$.



Fig. 9. The two influence graphs which have periodic attractors oscillating in 3 or 4 dimensions. All arcs represent inhibitions between genes.

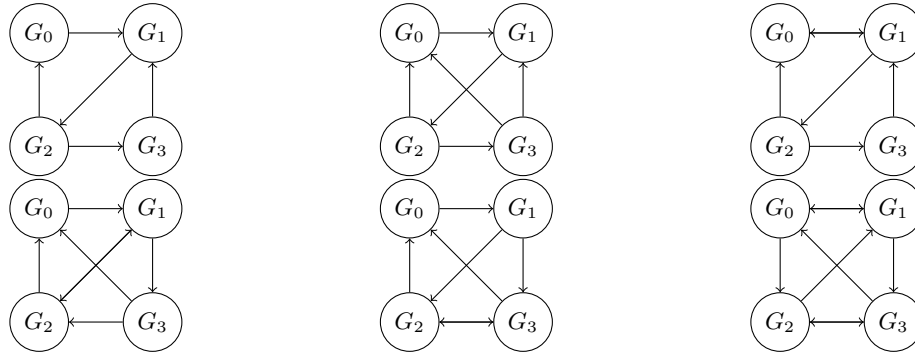

Fig. 10. The six influence graphs which have periodic attractors oscillating only in 4 dimensions. All arcs represent inhibitions between genes.

like to prove this result in a more mathematical way, and try to extend this result for repressilators in N dimensions.

We also want to apply this method for other models of interest in biology, attempting to generalize this work to show that certain dynamic patterns are caused by particular topological features.

The topological feature used in this work, that is, the total out-degree of cycles of length n , could be potentially simplified based on other more common features. If it is possible, the simplified result could be more easily used for the design of new synthetic circuits.

Meanwhile, only the topology of influence graphs is considered in this paper. For future works, we will also investigate how the relations between thresholds influence some complex dynamical properties.

Finally, in this work, we only use a decision tree to guide the search of the condition. For future works, we will also try other learning methods based on logic programming which could be more adapted for this kind of problem.

Acknowledgements We would like to thank Gilles Bernot and Jean-Paul Comet for their fruitful discussions. We would also like to thank Coraly Soto for her internship report which helped us in the early stage of this work to find features to predict the existence of a periodic attractor.

References

1. Abou-Jaoudé, W., Ouattara, D.A., Kaufman, M.: From structure to dynamics: frequency tuning in the p53–mdm2 network: I. logical approach. *Journal of theoretical biology* **258**(4), 561–577 (2009)
2. Akutsu, T., Kosub, S., Melkman, A.A., Tamura, T.: Finding a periodic attractor of a boolean network. *IEEE/ACM transactions on computational biology and bioinformatics* **9**(5), 1410–1421 (2012)
3. Almeida, S., Chaves, M., Delaunay, F.: Control of synchronization ratios in clock/cell cycle coupling by growth factors and glucocorticoids. *Royal Society Open Science* **7**(2), 192054 (2020)
4. Barik, D., Baumann, W.T., Paul, M.R., Novak, B., Tyson, J.J.: A model of yeast cell-cycle regulation based on multisite phosphorylation. *Molecular systems biology* **6**(1), 405 (2010)
5. Behaegel, J., Comet, J.P., Bernot, G., Cornillon, E., Delaunay, F.: A hybrid model of cell cycle in mammals. *Journal of bioinformatics and computational biology* **14**(01), 1640001 (2016)
6. Bernot, G., Comet, J.P., Khalis, Z.: Gene regulatory networks with multiplexes. In: *European simulation and modelling conference proceedings*. pp. 423–432 (2008)
7. Boyenval, D., Bernot, G., Collavizza, H., Comet, J.P.: What is a cell cycle checkpoint? the totombionet answer. In: *Computational Methods in Systems Biology: 18th International Conference, CMSB 2020, Konstanz, Germany, September 23–25, 2020, Proceedings 18*. pp. 362–372. Springer (2020)
8. Buşe, O., Pérez, R., Kuznetsov, A.: Dynamical properties of the repressilator model. *Physical Review E* **81**(6), 066206 (2010)
9. Comet, J.P., Fromentin, J., Bernot, G., Roux, O.: A formal model for gene regulatory networks with time delays. In: *International Conference on Computational Systems-Biology and Bioinformatics*. pp. 1–13. Springer (2010)
10. Cornillon, E., Comet, J.P., Bernot, G., Enée, G.: Hybrid gene networks: a new framework and a software environment. *advances in Systems and Synthetic Biology* (2016)
11. Elowitz, M.B., Leibler, S.: A synthetic oscillatory network of transcriptional regulators. *Nature* **403**(6767), 335–338 (2000)
12. Goh, K.I., Kahng, B., Cho, K.H.: Sustained oscillations in extended genetic oscillatory systems. *Biophysical Journal* **94**(11), 4270–4276 (2008)
13. Karlebach, G., Shamir, R.: Modelling and analysis of gene regulatory networks. *Nature reviews Molecular cell biology* **9**(10), 770–780 (2008)
14. Kauffman, S.A.: Metabolic stability and epigenesis in randomly constructed genetic nets. *Journal of theoretical biology* **22**(3), 437–467 (1969)
15. Khalis, Z., Comet, J.P., Richard, A., Bernot, G.: The smbionet method for discovering models of gene regulatory networks. *Genes, genomes and genomics* **3**(1), 15–22 (2009)
16. Li, Z., Liu, S., Yang, Q.: Incoherent inputs enhance the robustness of biological oscillators. *Cell systems* **5**(1), 72–81 (2017)
17. Ma, W., Lai, L., Ouyang, Q., Tang, C.: Robustness and modular design of the drosophila segment polarity network. *Molecular Systems Biology* **2**(1), 70 (2006)
18. Melkman, A.A., Tamura, T., Akutsu, T.: Determining a singleton attractor of an and/or boolean network in $O(1.587^n)$ time. *Information Processing Letters* **110**(14–15), 565–569 (2010)

19. Page, K.M.: Oscillations in well-mixed, deterministic feedback systems: Beyond ring oscillators. *Journal of Theoretical Biology* **481**, 44–53 (2019)
20. Paulevé, L., Kolčák, J., Chatain, T., Haar, S.: Reconciling qualitative, abstract, and scalable modeling of biological networks. *Nature communications* **11**(1), 4256 (2020)
21. Paulevé, L., Richard, A.: Static analysis of boolean networks based on interaction graphs: a survey. *Electronic Notes in Theoretical Computer Science* **284**, 93–104 (2012)
22. Perez-Carrasco, R., Barnes, C.P., Schaerli, Y., Isalan, M., Briscoe, J., Page, K.M.: Combining a toggle switch and a repressilator within the ac-dc circuit generates distinct dynamical behaviors. *Cell systems* **6**(4), 521–530 (2018)
23. Potvin-Trottier, L., Lord, N.D., Vinnicombe, G., Paulsson, J.: Synchronous long-term oscillations in a synthetic gene circuit. *Nature* **538**(7626), 514–517 (2016)
24. Qiao, L., Zhao, W., Tang, C., Nie, Q., Zhang, L.: Network topologies that can achieve dual function of adaptation and noise attenuation. *Cell systems* **9**(3), 271–285 (2019)
25. Remy, É., Ruet, P., Thieffry, D.: Graphic requirements for multistability and attractive cycles in a boolean dynamical framework. *Advances in Applied Mathematics* **41**(3), 335–350 (2008)
26. Ribeiro, T., Folschette, M., Magnin, M., Inoue, K.: Learning any semantics for dynamical systems represented by logic programs (2020)
27. Richard, A.: Negative circuits and sustained oscillations in asynchronous automata networks. *Advances in Applied Mathematics* **44**(4), 378–392 (2010)
28. Richard, A., Comet, J.P.: Necessary conditions for multistationarity in discrete dynamical systems. *Discrete Applied Mathematics* **155**(18), 2403–2413 (2007)
29. Richard, A., Tonello, E.: Attractor separation and signed cycles in asynchronous boolean networks. *Theoretical Computer Science* p. 113706 (2023)
30. Sun, H., Comet, J., Folschette, M., Magnin, M.: Condition for sustained oscillations in repressilator based on a hybrid modeling of gene regulatory networks. In: *Proceedings of the 16th International Joint Conference on Biomedical Engineering Systems and Technologies - BIOINFORMATICS*, pp. 29–40. INSTICC, SciTePress (2023). <https://doi.org/10.5220/0011614300003414>
31. Sun, H., Folschette, M., Magnin, M.: Limit cycle analysis of a class of hybrid gene regulatory networks. In: *Computational Methods in Systems Biology: 20th International Conference, CMSB 2022, Bucharest, Romania, September 14–16, 2022, Proceedings*. pp. 217–236. Springer (2022)
32. Thomas, R.: Boolean formalization of genetic control circuits. *Journal of theoretical biology* **42**(3), 563–585 (1973)
33. Thomas, R.: Regulatory networks seen as asynchronous automata: a logical description. *Journal of theoretical biology* **153**(1), 1–23 (1991)
34. Tomazou, M., Barahona, M., Polizzi, K.M., Stan, G.B.: Computational re-design of synthetic genetic oscillators for independent amplitude and frequency modulation. *Cell systems* **6**(4), 508–520 (2018)
35. Zhang, F., Sun, Y., Zhang, Y., Shen, W., Wang, S., Ouyang, Q., Luo, C.: Independent control of amplitude and period in a synthetic oscillator circuit with modified repressilator. *Communications Biology* **5**(1), 23 (2022)