



HAL
open science

Quantitative air risk assessment for a drone inspection mission along fast train lines

Xavier Olive, Patrick Le Blaye, Leonid Sedov, Timothé Krauth

► **To cite this version:**

Xavier Olive, Patrick Le Blaye, Leonid Sedov, Timothé Krauth. Quantitative air risk assessment for a drone inspection mission along fast train lines. Air Traffic Management Research and Development Seminar (ATM) 2023, Jun 2023, SAVANNAH, United States. hal-04131557

HAL Id: hal-04131557

<https://hal.science/hal-04131557v1>

Submitted on 16 Jun 2023

HAL is a multi-disciplinary open access archive for the deposit and dissemination of scientific research documents, whether they are published or not. The documents may come from teaching and research institutions in France or abroad, or from public or private research centers.

L'archive ouverte pluridisciplinaire **HAL**, est destinée au dépôt et à la diffusion de documents scientifiques de niveau recherche, publiés ou non, émanant des établissements d'enseignement et de recherche français ou étrangers, des laboratoires publics ou privés.

Quantitative air risk assessment for a drone inspection mission along fast-train lines

Xavier Olive*, Patrick Le Blaye*, Leonid Sedov† and Timothé Krauth*‡

*ONERA – DTIS
 Université de Toulouse
 Toulouse, France
 Salon de Provence, France

†Communications and Transport Systems
 Department of Science and Technology
 Linköping University
 Norrköping, Sweden

‡Centre for Aviation
 School of Engineering
 Zurich University of Applied Sciences
 Winterthur, Switzerland

Abstract—The availability of large-scale air traffic data, including aircraft operating at very low levels, opens new possibilities for a quantitative evaluation of the risk of mid-air collisions for drones, esp. in beyond visual line-of-sight operations. The contribution of this paper boils down to a three-fold evaluation of such a risk using the reference qualitative approach, the Specific Operations Risk Assessment (SORA), and two quantitative approaches inspired from the literature. Quantitative assessment makes the most of the data collected through cooperative technologies such as ADS-B and FLARM by estimating distributions and indicators from real data instead of using generic assumptions. In the following, we perform risk analyses of a realistic drone inspection mission along fast-train lines, and show how the quantitative analysis of the air risk could help to determine when such a mission could be executed in conformance with the existing framework of SORA.

Keywords—unmanned aircraft, ADS-B, FLARM, risk assessment, midair collision, BVLOS operations

I. INTRODUCTION

The concept of drone operations at very low levels (VLL), esp. for beyond visual line-of-sight (BVLOS) operations, has been maturing for decades, and is strongly related with safety requirements defined by authorities. Risk assessment is at the core of planning and approving drone operations. Unmanned aircraft (UA) operate in airspaces that they must share with other users, including commercial aircraft, General Aviation (GA), armed forces, firefighters, gliders, and more.

Drone BVLOS operations at VLL most often present a moderate level of risk and thus belong to the “Specific” category under the European regulation [1]. These operations are subject to approval by the competent authority based on a risk analysis performed by the operator using e.g., the Specific Operations Risk Assessment (SORA) methodology [2], [3]. This methodology consists of a step-by-step assessment of ground and air risks, the former representing the third party risk imposed by unmanned operations on the population and the latter being related to the risk of collision with other airspace users, i.e. manned aircraft. Both ground and air risk models of SORA are based on generalized descriptions of the operational environment, and as such can be considered as primarily qualitative.

Mid-air collision (MAC) is classified as a rare event and must be treated as such when addressing the risk estimation with statistical methods: large datasets and a high number of simulations are required in order to properly assess such

small probabilities. On one hand, fundamental work by the MIT Lincoln Laboratory (MIT/LL) [4], [5] addressed the problem through the evaluation of less rare events, *near mid-air collision* (NMAC) and *encounters*, and used extensive simulations to estimate the value of $p(\text{MAC} | \text{NMAC})$ at 10^{-2} and to define a well clear volume for small UAS [6]. Although the SORA approach for air risk assessment is qualitative, it is mainly based on assumptions and results from this approach [7]. On the other hand, la Cour-Harbo [8] uses distributions of aircraft dimensions and trajectory parameters in order to directly assess the MAC risk.

Large-scale availability of open data (ADS-B, Mode S, FLARM) received from cooperative traffic paves the way for a data-based methodology for a quantitative assessment of the mid-air collision risk. In [9], we presented the feasibility of such analysis based on the data collected through the OpenSky Network [10], and further based on data collected by a receiver we operate on our Salon-de-Provence facility.

As a case study, we consider a drone inspection mission along a fast-train line in Southeastern France, between Avignon and Aix-en-Provence stations. The area is rather well covered by an ADS-B, Mode S and FLARM ground receiver which provides enough low-altitude data for a quantitative assessment of the mid-air collision risk. We assess the risk using different approaches:

- 1) the SORA approach, as a qualitative methodology, serves as a baseline;
- 2) a quantitative methodology based on chains of conditional probabilities, incl. near mid-air collisions, well clear violations and encounters, by MIT/LL [4], [5];
- 3) a quantitative methodology based on geographical, trajectory parameters and altitude distributions, strongly inspired by la Cour-Harbo [8], that we adapt in order to compute a NMAC risk rather than a MAC risk.

We compare the results of both quantitative approaches, and explain how these can help to refine the analysis made with the SORA approach with tangible information from a small sample of historical trajectories.

We present the general methodologies in Section II before applying them on a specific case study (Section III) of a long range drone inspection mission along a fast-train railway in Southeastern France. Results are then discussed in Section IV before a conclusion in Section V.

II. METHODOLOGY

A. Data sources

ADS-B (Automatic Dependent Surveillance—Broadcast) is a technology based on transceivers, electronic on-board devices which help to identify aircraft on air traffic control (ATC) radars. Unlike transponders, transceivers emit signals on the 1090 MHz frequency but do not require interrogations. The FAA and the European Commission issued regulations to mandate aircraft to be ADS-B compliant, but these mostly apply to large and fast aircraft flying in designated airspaces.

Low altitude ADS-B coverage is affected by the very low equipage rate for General Aviation aircraft, as documented in [11]: as a result, even a ground receiver with a good low altitude coverage will not provide any trajectory information for a significant portion of General Aviation aircraft.

FLARM is, with TCAS [12], one of the most widespread technologies for traffic awareness and collision avoidance, initially designed for gliders, light aircraft, rotorcraft, and drones. FLARM obtains its position and altitude readings from a GPS antenna and an internal barometric sensor, then broadcasts these together with forecast data about the future 3D flight track. At the same time, its receiver listens for other FLARM devices within range and processes the information received. Although the FLARM radio protocol features message encryption in order to ensure integrity and confidentiality, implementation and encryption keys are available: the Open Glider Network (OGN) maintains a tracking platform with the help of many receivers, mostly collocated with flying clubs operating light aircraft at local airfields. The OpenSky Network [10] also collects FLARM raw messages, with data accessible to institutional researchers.

The transponders equipping most General Aviation aircraft are Mode A/C transponders only: they reply to Secondary Surveillance Radars (SSR) with *squawk* (Mode 3/A) and *altitude* information (Mode 3/C), by increments of 100 feet. Mode S is a further extension of Mode A/C where queries are addressed to specific aircraft (S stands for selective).

We documented in [9] how to combine trajectory information from those sources (ADS-B, FLARM and Mode S) to create density maps at various altitude levels, and use such distributions to compute a mid-air collision risk. We use here data collected below 3,000 feet (about 914 meters) between 15 and 30 June 2022 in the vicinity of Salon-de-Provence air base (LFMY) in Southern France.

Figure 1 highlights the importance of FLARM data when analysing aircraft trajectories below 1000 meters. FLARM messages contain a field for the aircraft type, which also helps to specify particular behaviours in quantitative analyses.

B. The SORA methodology

SORA is recognized as a reference methodology for a UAS operator to assess the risks of a planned operation in the specific category and to apply for approbation by the competent authority [3]. It proceeds through 10 steps, starting from the concept of operation and the ground risk, before addressing the air risk.

The initial air risk assessment is currently performed using the decision tree in step 4 of SORA, taking as inputs the

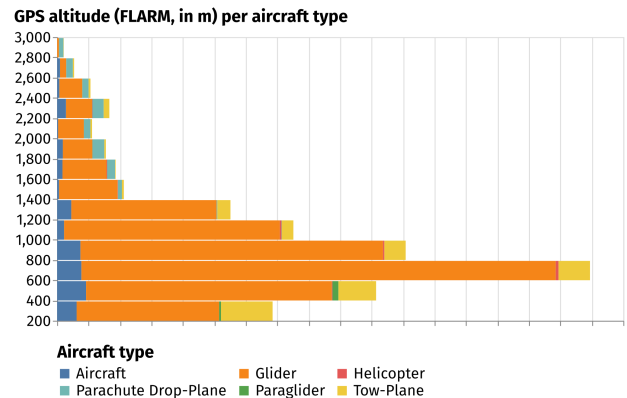

Figure 1: Vertical distribution of FLARM trajectories, based on data collected during 15 days. Most activity is low-altitude; apart from gliders and tow-planes where FLARM is mandatory, General Aviation and Helicopters are also represented.

intended operating environment (airport proximity, airspace class, urban vs rural area, etc.) (Figure 2). This step determines the airspace encounter category (AEC) and its associated air risk class (ARC), ranging from ARC-a (lowest risk) to ARC-d (high risk).

Optionally, the applicant may then ask for a reduction of the ARC (SORA step 5) by demonstrating that the actual level of risk is lower than the generalized initial ARC. This demonstration should typically be supported by an analysis of actual traffic data, based on a methodology up to now left to the applicant. Note that the applicant may alternatively claim an ARC reduction by using common structures and rules, including e-conspicuity, NOTAM and the use of U-space services.

The next steps of SORA combine ground and air risks to derive requirements for strategic or tactical mitigation in order to reach the target level of safety. In particular, equipment with a Detect and Avoid system of adequate performance may be required to mitigate the risk of mid-air collisions.

C. MAC estimation using Encounter or Well Clear volumes

As a first quantitative approach, we consider the methodology initially developed by MIT/LL [4]–[6] and still widely used in the assessment of collision avoidance systems such as ACAS (Airborne Collision Avoidance System) and STCA (Short Term Conflict Alert). This approach is based on a probabilistic decomposition of the mid-air collision rate of the following form:

$$\text{MAC}_{\text{rate}} = p(\text{MAC} | \text{NMAC}) \cdot p(\text{NMAC} | \text{Enc}) \cdot \text{Enc}_{\text{rate}} \quad (1)$$

The approach aims to estimate the number of mid-air collision per flight hour MAC_{rate} , which is ultimately expected to be lower than the *target level of safety* (TLS).

A *near mid-air collision* (NMAC) is defined as the situation where two aircraft come closer than 500 feet horizontally and 100 feet vertically. $p(\text{MAC} | \text{NMAC})$ is the probability of MAC given that a NMAC occurred. $p(\text{MAC} | \text{NMAC})$ reflects the role of (lack of) providence in collision avoidance. Given the small dimension of the UA compared to the typical

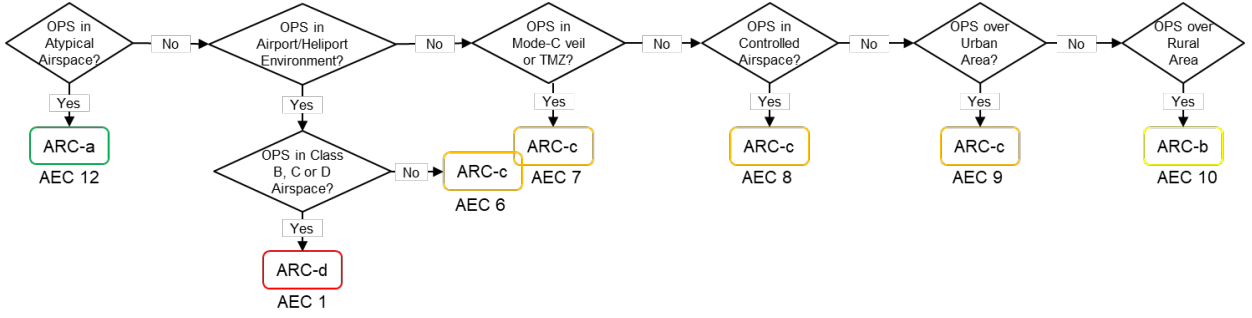

Figure 2: SORA decision tree for VLL operations (adapted from SORA)

dimensions of manned aircraft, it has been estimated at 10^{-2} in [5], [6].

The approach then uses the concept of *encounter* (Enc). An encounter occurs when two aircraft come simultaneously in a predefined volume. The encounter volume is generally chosen to characterize situations which may evolve into a NMAC within a certain time horizon, depending on the conflict geometry and dynamics. For instance, for small UA operations in uncontrolled airspace, the SORA is based on a definition of the encounter volume of 3000 feet horizontally and 350 feet vertically. Then $p(\text{NMAC} | \text{Enc})$ is the probability of an NMAC given an encounter has occurred. Finally, Enc_{rate} is the expected number of encounters per flight hour. This rate, of course, depends on the encounter definition, in balance with $p(\text{NMAC} | \text{Enc})$.

A key benefit of this approach is that it does not require assumptions or data regarding the dimensions of unmanned and manned aircraft, as well as their speeds. These effects are indeed captured by the predetermined value of $p(\text{MAC} | \text{NMAC})$, within certain limits (small UA weighting less than 55 pounds and with speed below 60 knots) [6].

The encounter definition also can be tuned to capture situations which are both safety relevant and accessible to measure over relatively small traffic datasets. However, little consensus exists on its definition, which is mostly relevant to guide the initial conditions of numerical simulations. Rather, we proposed in [9] a definition of a *surveillance volume* based on the conditions of potential conflict situations in BVLOS operations.

Interestingly, equation (1) can be used with *well clear violation* (WCV) rather than encounter. “Well clear” is indeed related to real operations, as pilots in uncontrolled airspace are expected to maintain the well clear distance with other aircraft in order to ensure safety. This distance is however subjective, but a definition was required to support the design of detect and avoid systems for UA. The definition of WC has thus been a subject of research first for large UA [13] and later for small UA [6]. Simulations using encounter models based on actual traffic data resulted in a well clear recommendation of 2000 feet horizontally and 350 ft vertically. This definition is expected to provide an estimated probability $p(\text{NMAC} | \text{WCV})$ equal to 10^{-1} .

Based on these assumptions, only WCV_{rate} remains to be determined, if possible, based on actual traffic data.

D. MAC estimation inspired by la Cour-Harbo methodology

As the second collision rate estimation technique, we adopted the methodology presented by la Cour-Harbo in [8]. This methodology models general aviation and unmanned aircraft as cylinders with radius r_{GA} and r_{UA} respectively, and height h_{GA} and h_{UA} respectively, that independently move within a geographical area A . The airspace where UA are allowed to operate is bounded above at altitude z_{max} . The geographical positions and heading directions of both the GA aircraft and the UA are assumed to be uniformly distributed. The methodology defines MAC as an intersection of two cylinders and separately computes the horizontal conflict rate p_{HC} (i.e., how often the UA will be within $r_{\text{GA}} + r_{\text{UA}}$ from any aircraft) and the probability of vertical conflict p_{VC} (i.e., if a UA and an aircraft have horizontal conflict, what is the probability that the vertical distance between them is less than $h_{\text{UA}} + h_{\text{GA}}$). Usually, general aviation is flying above the airspace where drones are allowed to operate, so in order to account for that, the model introduces the parameter p_{below} , that represents the probability that an aircraft will fly below z_{max} . λ_{STM} represents the strategic and tactical mitigation capabilities of both drones and general aviation.

The rate of MAC arising from a particular type of aircraft is then defined as

$$p_{\text{MAC}} = p_{\text{HC}} \cdot p_{\text{VC}} \cdot p_{\text{below}} \cdot \lambda_{\text{STM}}. \quad (2)$$

If there are several aircraft types, the total MAC rate is approximated as the sum of individual MAC rates for each aircraft type.

The *horizontal conflict rate* (p_{HC}) is estimated by computing the size G of the area of interest A , and estimating the ratio of airborne time $T = t_{\text{airborne}}/t_{\text{period}}$ in that area, where t_{airborne} is the airborne duration of the aircraft and t_{period} is the reference observation time. Then, given the mean ground speed of aircraft and drone (v_{GA} and v_{UA} respectively), the horizontal conflict rate is defined as:

$$p_{\text{HC}} = \frac{2(r_{\text{GA}}^2 + r_{\text{UA}}^2)T\sqrt{v_{\text{GA}}^2 + v_{\text{UA}}^2}}{(r_{\text{GA}} + r_{\text{UA}})G}. \quad (3)$$

The *probability of vertical conflict* (p_{VC}) is the probability that two cylinders intersect vertically, given that they overlap horizontally (i.e., their projections to the horizontal plane intersect). Assuming that the altitudes of the aircraft and the UA are described by the probability density functions $f_{\text{GA}}(z)$

and $f_{UA}(z)$ respectively (F_{GA} and F_{UA} are the respective cumulative distribution functions), the probability of vertical conflict is

$$\begin{aligned}
 p_{VC} &= \iint_{\substack{|\alpha-\beta| \leq h_{GA}+h_{UA} \\ \beta < z_{\max}}} f_{GA}(\alpha) f_{UA}(\beta) d(\alpha, \beta) d\beta d\alpha \\
 &= \int_0^{z_{\max}} f_{UA}(\beta) \left(F_{GA} \left(\beta + \frac{h_{GA} + h_{UA}}{2} \right) \right. \\
 &\quad \left. - F_{GA} \left(\beta - \frac{h_{GA} + h_{UA}}{2} \right) \right) d\beta. \quad (4)
 \end{aligned}$$

We refer the reader to [8] for details about the p_{HC} and p_{VC} equations.

Despite the fact that the methodology was designed to compute MAC, it can be directly applied to compute NMAC by adjusting the appropriate conflict thresholds (r_{GA} , r_{UA} , h_{GA} , and h_{UA}) to half of the horizontal and vertical expected NMAC separation.

III. CASE STUDY

A. Problem description

We consider here a drone inspection mission along the fast-train line between Aix-en-Provence and Avignon in South-eastern France. The area is well covered by a receiver we operate on the LFMY airbase BA 701 in Salon-de-Provence [9].

This area in Southeastern France, near Marseille, is of particular interest for this study as it hosts a wide variety of landscapes (plains and foothills) and aircraft activities:

- Marseille–Provence (LFML) is the major commercial hub, also hosting Airbus Helicopters test flights;
- Istres Le Tubé (BA125/LFMI) and Salon (BA701/LFMY) are military facilities: LFMY hosts the air force academy with light aircraft and gliders for initial training; Nîmes–Garons (LFTW) is close to our area of interest and hosts Sécurité Civile’s firefighter aircraft;
- Aix–Les Milles (LFMA) is a large general aviation field, also hosting tests flights for Guimbal helicopters;
- LFMV, LFNE, LFNR, LFNT and LFNZ are other general aviation airfields in the area.

The drone trajectory during railway inspection can be slightly shifted off the railway for perspective considerations, but we consider this negligible as we operate on the scale of traffic densities anyway. Those densities are computed based on historical ADS-B, Mode S and FLARM traffic data below 3000 feet (ca. 914 m) between 15 and 30 June 2022: even though drones must operate below 500 feet (ca. 152 m), operations are still heavily impacted by traffic above, especially by the layer between 500 and 1,200 feet.

Figure 4 reveals an excellent low altitude coverage in the Southern part of the map, and only down to 2,000 ft (ca. 609 m) in the North (probably due to the hills around).

- Traffic density maps (Figure 3) show little traffic below 500 ft, mostly concentrated around airfields in the area. Traffic below 500 ft to the North (LFNZ, LFMV) is unfortunately out of coverage;

- The 500 to 1,200 ft layer reveals possible interaction of a potential drone trajectory following the railway with glider activity around LFMY, and with general aviation activity around LFMA (and LFML to a lesser extent);
- Between 1,200 ft and 3,000 ft, the map suggests that general aviation tends to use the railway as a landmark to navigate out or to LFMA.

Even though we do not observe in two weeks of historical data any aircraft trajectory intersecting the railway below 500 ft AGL, traffic in lower altitudes has an impact on the perceived and computed risk. The quantitative methodologies that we implemented separate the lateral profiles from the vertical distribution of aircraft.

B. Qualitative analysis with SORA

As shown on Figure 5 the fast train line crosses airport control zones (CTR Provence, Aix and Avignon – airspace class D). Between these zones, the surrounding airspace includes some military restricted areas (R330A, R77A) and is mostly class G with military control during activation hours.

Based on the SORA decision tree, an operation following this line falls for about 47% of its length under the airspace encounter category “VLL in controlled airspace” (AEC 8) with a medium level of risk (ARC-c). Other portions of the trajectory belong for about 40% to “Ops in airport environment in class D airspace” (AEC 1 – ARC-d) and for 13% to “Ops over rural area” (AEC 10 – ARC-b). As a result, we consider applying for a generalized, aggregated, initial air risk as ARC-c. This level of risk corresponds to a traffic density rating of 3 over a scale ranging from 1 to 5.

Given this initial ARC-c, the applicant may claim a reduction to ARC-b if the local density can be demonstrated to be similar to the reference environment “VLL ops over rural area” with a density rating of 1 (ref. SORA table C.2). This density rating corresponds to an unmitigated MAC rate of 10^{-7} per flight hour, equal to the target level of safety for general aviation [7].

C. Quantitative analysis with WCV approach

With the rationale of section II-C, we apply the following equation in order to determine the MAC rate:

$$\text{MAC}_{\text{rate}} = p(\text{MAC} | \text{NMAC}) \cdot p(\text{NMAC} | \text{WCV}) \cdot \text{WCV}_{\text{rate}} \quad (5)$$

with the following values provided by [5], [6]:

- $p(\text{MAC} | \text{NMAC}) = 10^{-2}$
- $p(\text{NMAC} | \text{WCV}) = 10^{-1}$

We noticed that the last value was determined in [6] by means of numerical simulations with a detailed encounter model based on radar data collected over the territory of the USA and considering small UA operations up to 1200 feet altitude. In order to assess whether the value was representative also for VLL operations, we built an analytical model to estimate it with the expected conditions.

The model assumes that the intruder is entering the WC cylinder surrounding the UA with a uniform distribution of relative horizontal speed and vertical speed within plus or minus a maximal path angle. The probability of NMAC is

Traffic density at very low levels (ADS-B and FLARM)

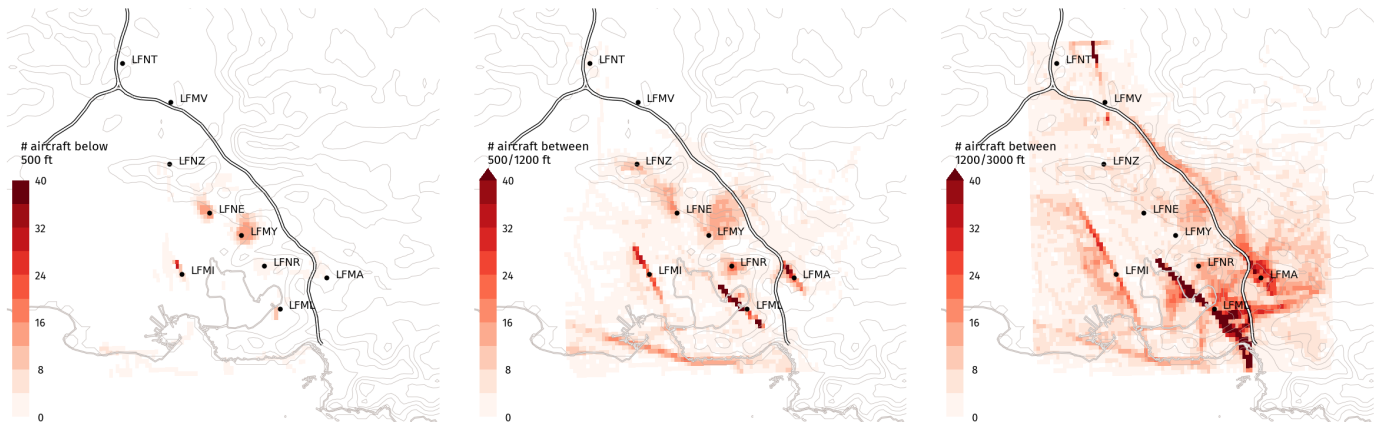

Figure 3: Traffic density around Salon-de-Provence at very low levels: activity below 500 ft is mostly detected in the plain areas, where hills do not hamper coverage. At higher altitudes, the map suggests possible conflicts between a trajectory following the railway and 1) glider activity near LFMY; 2) aircraft using the railway as a visual landmark between LFMA and LFMV; 3) commercial traffic to or from LFML.

Minimal GPS altitude detected (AGL)

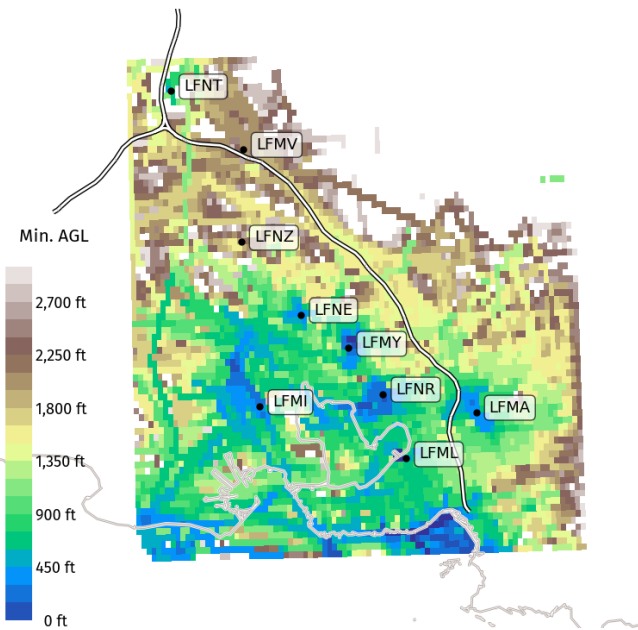

Figure 4: Minimum AGL altitude detected by our receiver for aircraft equipped with either ADS-B or FLARM transceiver.

then integrated over the side and above surface of the cylinder; the below surface is not considered, as manned aircraft are not expected to come from under the UA in VLL operations. The resulting risk contours are shown on figure 6 for a max path angle of 10 degrees. For the recommended WC volume of 2000 feet x 250 feet, the probability is around 6.10^{-2} ; this value compares well with the expected value of 10^{-1} . We stand with the latter value, as it is the most conservative.

The next step is to estimate $p(WCV)$ along the drone operation trajectory. This can be done based on the collected traffic data by counting the number of aircraft for a given period within cells of size equal to the WC volume (cylinder of 2000 ft radius and 500 ft height) along the trajectory,

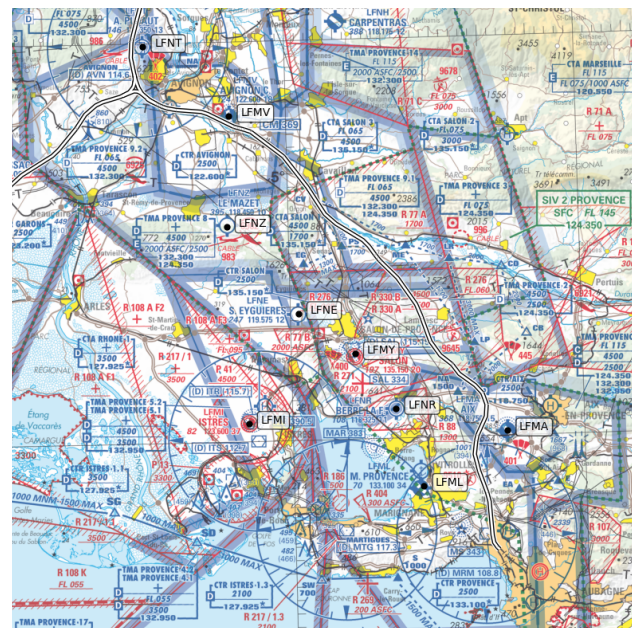

Figure 5: ICAO map showing the airfields, the airports and the control zones along the fast train line (double line style).

assuming that the drone flies at the maximal altitude of 500 ft AGL. In our example case, one hundred cells are distributed along the train line trajectory; these cells overlap partly as the length of the trajectory is about 70 km.

Out of the flight trajectories collected from June 15 to 30, around one hundred (108) intersect at least one cell; an intersection means a WCV. Due to the relative small size of the dataset, a significant portion of the cells (61%) were not intersected by any trajectories. The MAC rate is then calculated for each cell by dividing the number of WCV by the total duration of the traffic data collection (238 hours over sixteen days) and applying equation 5. The resulting MAC rates along the train line are shown on Figure 7.

MAC rates range from 6.2×10^{-6} to 6.7×10^{-5} , with a mean value of 1.2×10^{-5} per flight hour. The MAC rate is

NMAC rate (per hour) along the trajectory

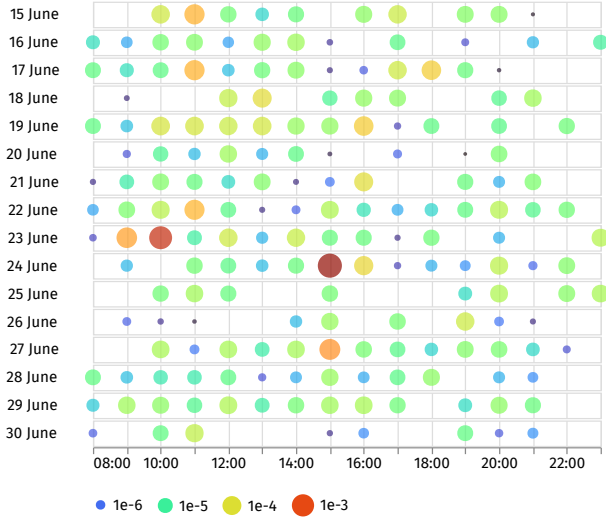

Figure 8: Historical NMAC rates observed between June 15 and June 30 and measured for every hour, based on historical ADS-B and FLARM trajectories (hours are shifted in local time)

Trajectories flying when the NMAC rate is higher

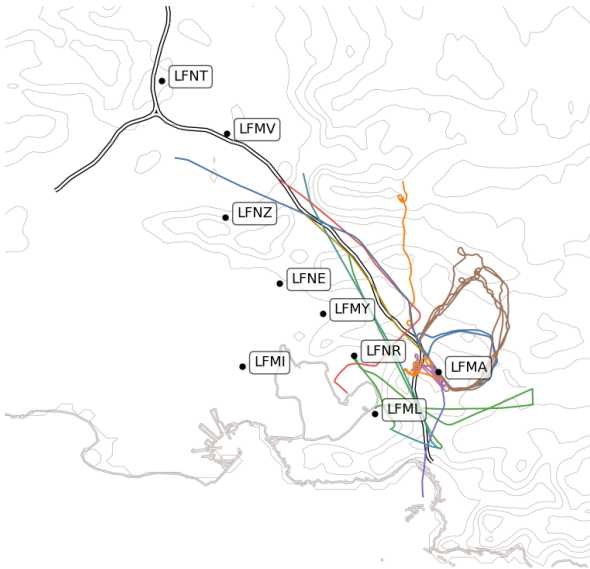

Figure 9: Aircraft trajectories that contributed most to high NMAC rates presented on Figure 8.

- 1) General Aviation aircraft seem to use the high-speed railway as a visual landmark, leading to an expected increase in NMAC rate;
- 2) landing and take-off trajectories for LFMA have a clear interaction with the railway footprint;
- 3) the glider activity to the North-West of LFMY that we detected on Figure 3 does not seem to have any significant impact on the NMAC rate.

Figure 10 plots the risk at different points along the railway and highlights specific hotspots where the mission planner should pay special attention. In order to ease comparison between the two quantitative methods, we use the assumption

MAC rate (per hour) with LCH approach

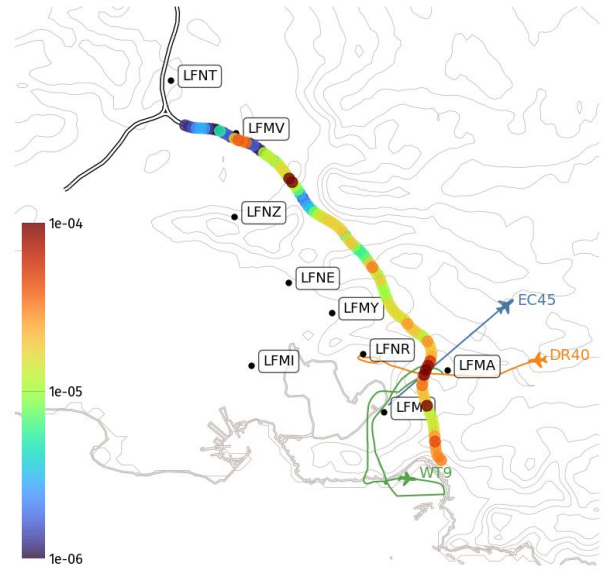

Figure 10: MAC rate as a function of the position along the railway, showing where the risk is higher. Three sample trajectories contributing to the high risk in a selected portion of the railway are added together with their type codes: EC45 is a helicopter; DR40 is a classical GA aircraft based in LFNZ; WT9 is an ultralight aircraft based in LFMA.

$p(\text{MAC} | \text{NMAC}) = 10^{-2}$ to display the MAC rate rather than the NMAC rate.

The major hotspot is located where the LFMA to LFNZ segment intersects the railway, which seems to be a point where many low-altitude trajectories fly: the map shows three of such trajectories which include an helicopter taking off from LFML (in blue), a Robin DR400 landing at LFNZ (in orange) and an ultralight flying from and to LFML (in green). The average NMAC rate can reach values up to 10^{-2} per hour, i.e. 10^{-4} MAC per hour, well above the TLS allowing an ARC reduction.

However, very low values north of LFNZ do not relate well with the activity at Avignon airport LFMV. As a matter of fact, the low-altitude trajectories we get from our receiver located at LFMY are partially masked by low mountains between LFNE and LFNZ, resulting in limitations visible on Figure 4. Before rushing to conclusions, a better coverage in the northern part of the map is probably necessary for a proper quantitative assessment in that part of the mission.

IV. DISCUSSION

The results of the analysis applied to our case studies demonstrate that, as is, the qualitative SORA methodology classifies the mission with a medium initial air risk (ARC-c). This means the mission cannot be approved without further mitigation, unless we can establish that the air risk is below the target level of safety of 10^{-7} .

We then use two quantitative methodologies to compute the MAC rate values along the railway. The two methodologies provide quite different risk values, because of their differing assumptions regarding the traffic distribution and also due to

the relatively small size of the traffic dataset. Nevertheless both allow to highlight temporal and geographical hotspots which could hamper safe operations of the mission.

For this specific mission, specific days and hours with intense general aviation activity, and areas in the vicinity of airfields would be subject to further analysis. On the other hand, the expected impact of glider activity near LFMY was not reflected in the computed risk.

Overall, the MAC rates along the trajectory should be expected to be very low, as we found no aircraft actually flying below 500ft along the railway. However, since the quantitative methodologies we considered decorrelate the horizontal and vertical distributions, the resulting risk is no longer negligible: as a matter of fact, a drone pilot would probably interrupt a mission if there is too much activity in low altitude above his intended trajectory.

Particularly low values in the North however, should be considered with caution, as these are most likely to be explained by a lack of appropriate coverage than by safer conditions. We would like to use this work as a way to encourage federations and local aero clubs: most of them are already equipped with FLARM receivers feeding the OpenGlider Network, but feeding both FLARM and ADS-B data with low-cost devices to open databases would benefit all airspace users in terms of safety.

Finally, resulting values correspond to a risk for traffic without proper tactical and strategical mitigation strategies. Detect and avoid solutions for drones and other airspace users remain unavoidable in most cases for a safe operations of very low levels. Moreover, the quantitative risk analysis provide a basis to refine their performance requirements.

V. CONCLUSION

While SORA and similar qualitative methodologies were an important step forward, enabling the first UAS operators to assess risks related to their flight plans, quantitative assessment methodologies pave the way for a more precise estimation of the initial risk and for a better characterization of the need for risk mitigation via strategic (flight plan optimization) and tactical (detect and avoid) tools.

In this work, we implemented two quantitative air risk assessment methodologies, in order to complement the SORA analysis on a case study of a railway inspection scenario. Both methodologies demonstrate the feasibility of quantitative approaches based on actual traffic data. During our experiments, we applied these quantitative methodologies to model risks on a specific use case with a high degree of fidelity, providing insight on when and where the risk of collision with other airspace users is the highest. The conflict rates, produced by the quantitative methodologies, may also support claims for reduction of the air risk initially determined with the SORA methodology, by demonstrating that operating during certain hours is safe enough, thus allowing to avoid applying other mitigations.

Future works will include:

- a better estimation of the f_{GA} and p_{below} parameters, based on a large number of historical trajectories collected over significant parts of the territory;

- an estimation of risk based on more generic aircraft density maps rather than individual trajectories, possibly building upon the approach suggested in [14], in order to account for the aircraft that do not share their location, but which rough geographical location can be estimated by the proximity to the receiver;
- a complimentary analysis of the risk to the people and structures on the ground.

Finally, our work emphasizes the essential role of open flight data for the safety and efficiency of unmanned operations. Crowd sourcing of such data by local enthusiasts, professionals and aero clubs equipped with cheap hardware and an Internet connection benefits safe operations in VLL not only for UAS operators but also other airspace users, by providing an objective view of the traffic operating at lower altitudes.

ACKNOWLEDGEMENTS

This research was funded by the French General Directorate for Civil Aviation (DGAC) in the context of the research partnership PHYDIAS for safety improvement of UAS, by France Relance and by the European Union through Next Generation EU; and by the QRA project supported by Swedish Transport Administration (Trafikverket) via the Swedish Air Navigation Service provider (Luftfartsverket).

REFERENCES

- [1] The European Commission, "Commission Implementing Regulation (EU) 2019/947 of 24 May 2019 on the rules and procedures for the operation of unmanned aircraft," 2019.
- [2] JARUS, "Jarus guidelines on specific operations risk assessment (sora), issue 2.0," 2019. [Online]. Available: <http://jarus-rpas.org/content/jar-doc-06-sora-package>
- [3] EASA, "AMC and GM to commission implementing regulation (EU) 2019/947 – issue 1, 9 october 2019," 2019.
- [4] M. Kochenderfer, J. Kuchar, L. Espindle, and J. Griffith, "Uncorrelated Encounter Model of the National Airspace System, Version 1.0," MIT/LL Project report ATC-345, Tech. Rep., 2008.
- [5] M. Kochenderfer, D. Griffith, and J. Olszta, "On estimating mid-air collision risk," in *10th AIAA Aviation Technology, Integration, and Operations (ATIO) Conference*, 2010. [Online]. Available: <https://doi.org/10.2514/6.2010-9333>
- [6] A. Weinert, S. Campbell, A. Vela, D. Schuldt, and J. Kurucar, "Well-clear recommendation for small unmanned aircraft systems based on unmitigated collision risk," *Journal of Air Transportation*, vol. 26, no. 3, pp. 113–122, 2018. [Online]. Available: <https://doi.org/10.2514/1.D0091>
- [7] JARUS, "SORA Annex G Air Risk Collision Model (draft for external consultation, 2018-10-19)," 2018.
- [8] A. la Cour-Harbo and H. Schjøler, "Probability of Low-Altitude Midair Collision Between General Aviation and Unmanned Aircraft," *Risk Analysis*, vol. 39, no. 11, pp. 2499–2513, Nov. 2019. [Online]. Available: <https://doi.org/10.1111/risa.13368>
- [9] X. Olive and P. Le Blaye, "A Quantitative Approach to Air Traffic Safety at Very Low Levels," in *Proceedings of the 10th OpenSky Symposium*. Delft, The Netherlands: MDPI, Nov. 2022. [Online]. Available: <https://doi.org/10.3390/engproc2022028001>
- [10] M. Schäfer, M. Strohmeier, V. Lenders, I. Martinovic, and M. Wilhelm, "Bringing Up OpenSky: A Large-scale ADS-B Sensor Network for Research," in *13th IEEE/ACM International Symposium on Information Processing in Sensor Networks (IPSN)*, 2014.
- [11] J. Sun, X. Olive, M. Strohmeier, M. Schäfer, I. Martinovic, and V. Lenders, "OpenSky Report 2021: Insights on ADS-B Mandate and Fleet Deployment in Times of Crisis," in *Proceedings of the 40th IEEE/AIAA Digital Avionics Systems Conference (DASC)*, 2021.

- [12] M. Schafer, X. Olive, M. Strohmeier, M. Smith, I. Martinovic, and V. Lenders, "OpenSky Report 2019: Analysing TCAS in the Real World using Big Data," in *Proceedings of the 38th IEEE/AIAA Digital Avionics Systems Conference (DASC)*, 2019.
- [13] S. P. Cook, D. Brooks, R. Cole, D. Hackenberg, and V. Raska, "Defining Well Clear for Unmanned Aircraft Systems," *AIAA Infotech @ Aerospace*, no. AIAA paper 2015-0481, 2015.
- [14] L. Sedov, V. Polishchuk, T. Maury, M. Ulloa, and D. Lykova, "Qualitative and quantitative risk assessment of urban airspace operations," in *11th SESAR Innovation Days*, 2021.