



HAL
open science

Designing a sequence of transient EM signals in order to test railway wireless communications face to EM interferences produced by the catenary-pantograph contact

Artur de São José, Nathan Chopinet, Virginie Deniau, Eric Pierre Simon

► To cite this version:

Artur de São José, Nathan Chopinet, Virginie Deniau, Eric Pierre Simon. Designing a sequence of transient EM signals in order to test railway wireless communications face to EM interferences produced by the catenary-pantograph contact. International Symposium and Exhibition on Electromagnetic Compatibility (EMC Europe 2023), Sep 2023, Cracovie, Poland. hal-04127557

HAL Id: hal-04127557

<https://hal.science/hal-04127557>

Submitted on 13 Jun 2023

HAL is a multi-disciplinary open access archive for the deposit and dissemination of scientific research documents, whether they are published or not. The documents may come from teaching and research institutions in France or abroad, or from public or private research centers.

L'archive ouverte pluridisciplinaire **HAL**, est destinée au dépôt et à la diffusion de documents scientifiques de niveau recherche, publiés ou non, émanant des établissements d'enseignement et de recherche français ou étrangers, des laboratoires publics ou privés.

Designing a sequence of transient EM signals in order to test railway wireless communications face to EM interferences produced by the catenary-pantograph contact

Artur N. de São José

COSYS-LEOST, Univ Gustave Eiffel, IFSTTAR, Univ Lille
Villeneuve d'Ascq, France
artur.nogsj@gmail.com

Virginie Deniau

COSYS-LEOST, Univ Gustave Eiffel, IFSTTAR, Univ Lille
Villeneuve d'Ascq, France
virginie.deniau@univ-eiffel.fr

Nathan Chopinet

COSYS-LEOST, Univ Gustave Eiffel, IFSTTAR, Univ Lille
Villeneuve d'Ascq, France
nathan.chopinnet@univ-eiffel.fr

Eric Pierre Simon

Univ. Lille, CNRS, USR 3380 - IRCICA
Lille, France
eric.simon@univ-lille.fr

Abstract—The railway industry is facing a digital revolution with several wireless technologies disputing the electric transportation market. These candidate technologies have the challenge of ensuring continuity of service despite the presence of transient electromagnetic interference from the pantograph-catenary interface. In this context, we propose a procedure to design test waveforms that faithfully represents this physical phenomenon and, at the same time, can be easily generated in the laboratory to evaluate the susceptibility of railway communication systems. Experimental results involving the wireless technology LoRaWAN suggest that the transient sequence length can play a role in communication reliability.

Index Terms—transient interference, railway, wireless communication, lorawan, gsmr

I. INTRODUCTION

The occurrence of electric arcs between the high voltage aerial catenary lines and the pantograph contact located on the roof of the trains is well known by the railway industry. These arcs are a consequence of contact losses at the interface between these two conductive components. They result in broadband radiated electromagnetic interference (EMI) which can, in turn, be received by communication antennas installed at the roof of the trains [1], [2].

For this reason, it is important to test the susceptibility of railway wireless communication systems to these transient EMI. To do that, it is necessary to generate test EMI waveforms that resemble the real ones and, at the same time, that could be used in a bench test with a repeatable test procedure. Simple it may seem, this is effectively a challenging task.

This work was performed in the framework of the LoRa-R project, which is co-financed by the European Union with the European Regional Development Fund, the Hauts de France Region Council, and the SNCF railway company.

979-8-3503-2400-6/23/\$31.00 ©2023 IEEE

The electric arcs do not generally occur with regular time intervals along the route of a train [2]. Therefore, it is necessary that the test waveform contains several transients irregularly distributed in time [3]. To generate such a waveform using signal generators, a random trigger is necessary. However, it is impractical to generate random numbers on the same basis of the transient events (which occur in intervals of a few μ s [2]). So, our strategy is to create transient EMI sequences in a computational environment before the test and upload them in an arbitrary signal generator which will continuously repeat these sequences during the tests. The inconvenience of this approach is that the repetition of a finite-length sequence creates artificial frequencies which do not equally affect all communication channels.

To minimize the effects of such artificial frequencies, the solution is to increase the sequence length since the resulting spectrum is "flatter" and therefore it equally affects all communication channels. An ideal length is the symbol time of the communication protocol under test since it represents the time window used by a real radio receiver to extract information. Unfortunately, signal generators have limited memory, so this strategy eventually reaches a limit. Indeed, many samples are needed to generate one transient pulse, given that its rise and fall times have the order of magnitude of ns [2].

In this work, we propose a method to generate transient EMI sequences which can be integrated to test procedures devoted to the susceptibility of railway communication systems. These sequences are defined based on several parameters, among which are the repetition rate and the length. In a previous work [3], we investigated the impact of different repetition rates using short-duration transient EMI sequences. In the present contribution, we investigate the impact of different transient EMI sequence lengths on the communication reliability of

long-range wide-area network (LoRaWAN) systems. To the best of our knowledge, the EMI sequence length was not yet investigated, so the present work fills this gap in the literature. We discuss the trade-off between the capability of the transient EMI test waveforms to faithfully represent the physical phenomenon and the feasibility of generating them in the laboratory.

II. LORA SIGNALS

In this section, we introduce the main characteristic of LoRa signals. LoRa uplink and downlink signals represent the physical layer (PHY) of LoRaWAN systems. In our study, we focus on the uplink signals sent by a LoRa transceiver to the gateway and on acknowledgment (ACK) signals sent by the gateway to the LoRa transceiver. We study the case where the LoRa uplink signals are affected by transient EMI.

Figure 1 illustrates, in the time-frequency domain, a typical LoRa signal operating at the 868.3 MHz frequency band with a bandwidth 125 kHz. This waveform represents the transmission of one symbol belonging to the finite set $\{0, 1, 2, \dots, 2^{SF-1}\}$, where SF is the spreading factor ranging from 7 to 12 [4]. In this figure, we can see that the LoRa instantaneous frequency linearly increases with time until it reaches a maximum frequency. When this happens, the instantaneous frequency abruptly changes to the minimum frequency. This time instant (highlighted in Figure 1 with a red circle) is unique for each symbol. Therefore, if an EMI corrupts this part of the signal, the LoRa symbol extraction process is compromised.

III. EXPERIMENTAL TEST SETUP

Before introducing the method to generate transient EMI sequences, we describe the susceptibility test procedure. The test bench and susceptibility criterion are described. This criterion, called *critical SIR*, allows us to quantify the susceptibility levels of a LoRaWAN system subject to transient EMI.

A. Test bench

The proposed test bench is supposed to be of easy implementation, which includes testing in non-anechoic environments. This is possible thanks to the use of coaxial cables instead of antennas to connect all the wireless devices. One of

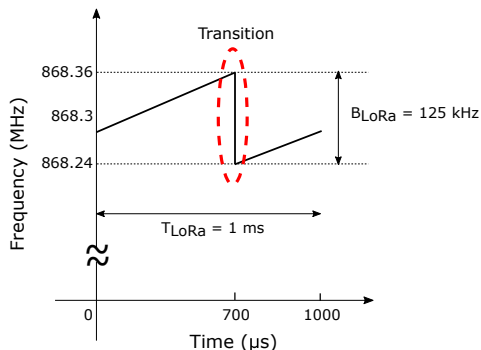

Fig. 1: LoRa signal in the time-frequency domain.

the positive aspects of this approach is that it avoids certain phenomena which are not the focus of the test to happen, *e.g.* polarization losses due to the misalignment between the LoRaWAN transmitting and receiving antennas. Besides, while most authors use complex test benches to generate the electric arcs in the laboratory [1], [5]–[7], we simply use MATLAB and a signal generator to create the transient disturbances. The signal generator used is an Agilent AWG70001A, which allows us to upload the transient EMI sequences created in MATLAB. The continuous mode transmission is chosen, meaning that the long sequence is repeated over time. During our tests, we were not able to upload more than 10 transient EMI sequences of 10 μ s each due to memory constraints. By doing so, the execution of the test is simplified, and we ensure repeatability since the waveform is generated by the software. Indeed, some authors have been discussing the possibility of using arbitrary signal generators to generate broadband EMC test signals [8].

Our test bench can be described based on the block diagram illustrated in Fig. 2. On the left side of this block diagram, we show how the communication signal and the EMI are combined together. On the right side, we show how the resulting signal simultaneously arrives at the receiver and at a spectrum analyzer. We use a LoRa transceiver (SX1276) to generate uplink signals which are sent to a gateway (Kerlink iFemto-Cell). If these signals are correctly received, the gateway sends an acknowledgment (ACK) signal to the LoRa transceiver. Furthermore, the gateway forwards the LoRa sensor data to an information technology (IT) structure comprising a switch, a web server, and a network server (the last one implemented with the ChirpStack application).

In our test bench, the signals received by the gateway are interfered with by a transient EMI sequence generated with an arbitrary signal generator. The LoRa signals and the transient EMI waveform are combined together by a splitter, and the resulting signal is simultaneously made available to the gateway and to a spectrum analyzer thanks to a second splitter. Finally, the test severity level given by the signal-to-interference ratio (SIR) is controlled with the help of an attenuator (Lab Brick Programmable Attenuator), which progressively decreases the power levels of the LoRa uplink signal during the test. Some of these pieces of equipment are illustrated in Fig. 3.

B. Critical SIR

As mentioned above, we use an attenuator to control the power levels of the LoRa uplink signals during the experiments. The idea is to start the test with moderate levels of interference *i.e.* with high SIR levels and to progressively increase the test severity levels by decreasing the SIR. This procedure is carried out until the gateway stops sending ACK signals to the LoRa transceiver. When this happens, we stop the test, and we note the current SIR level. This specific SIR value is called the *critical SIR*.

To measure the critical SIR, we first measure the LoRa and EMI power levels by using a spectrum analyzer and by

setting the attenuator to 0 dB, *i.e.* no attenuation is applied to the LoRa signal. The spectrum analyzer is configured in such a way as to emulate the LoRa input filters and other internal components of the gateway. The idea is to have an estimation of the power levels observed by the gateway, *i.e.* the effective SIR at the moment a LoRa symbol is extracted. This is achieved with a resolution bandwidth of 130 kHz (the closest to the commercial LoRa bandwidth of 125 kHz) and a sweep time of 1 ms (equivalent to the LoRa symbol time when the SF is 7). Once the LoRa and EMI power levels are measured with no attenuation applied, we have the reference SIR level. To obtain the critical SIR, we simply need to extract from it the attenuation at the moment the ACK is lost.

It is important to highlight that the threshold for temporary communication loss depends on each particular LoRaWAN application. Security-related applications such as those related to the door lock system cannot tolerate many packet losses. However, other communication systems may tolerate a higher amount of packet losses.

IV. TRANSIENT EMI SEQUENCE DESIGN

In this section, we describe the methodology to design a transient EMI sequence to be further used to test the susceptibility of railway wireless communication systems. First, we focus on a single transient, and then we introduce other transients to form a sequence. Finally, we discuss the characteristics of transient sequences with different lengths.

A. One single transient

The first step of our methodology is to generate one single transient. However, we do not need to generate all frequencies radiated by a real electric arc. If, on the one hand, the radiated EMI is broadband, on the other, the communication antennas placed on the roof of the train are narrow bands. Therefore, it is sufficient to generate the EMI frequencies which are

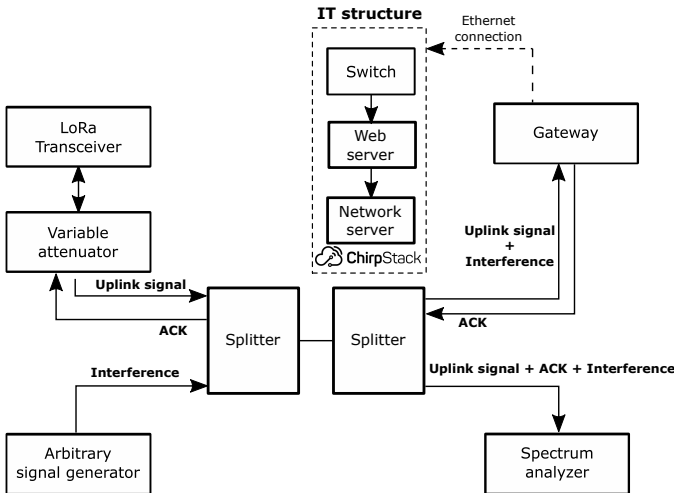

Fig. 2: Test bench equipment, interconnections, and signal flow.

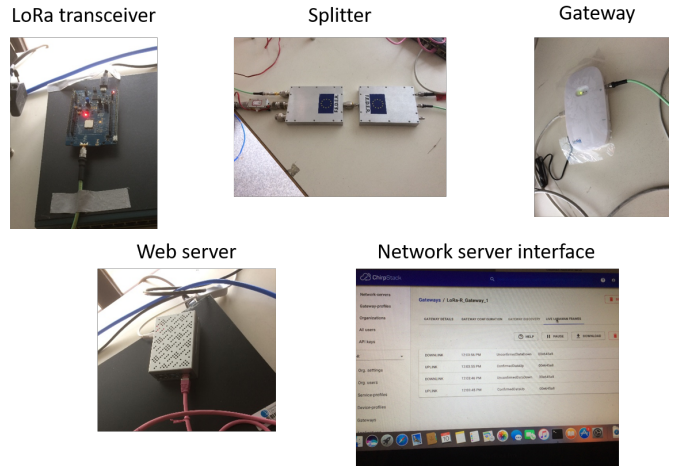

Fig. 3: Some equipment used in the experiments.

effectively received by these antennas. By doing so, we reduce the amount of power required from the signal generator.

To achieve this goal, we use this model:

$$S(t) = A \times [e^{(1/TD)t} - e^{(1/RT)t}] \times U(t) \times \sin(2\pi Ft), \quad (1)$$

where A is the amplitude, $U(t)$ is the unit step function, RT is the rise time, TD is the transient duration, and F is the central frequency of the communication channel, *i.e.* the "victim". In this work, we adopt $RT = 1$ ns, $TD = 10$ ns, and $F = 868.3$ MHz, the last one representing a LoRaWAN commercial frequency within the EU863-870 band.

Figure 4 illustrates this signal in time and frequency domains. We can see, in Fig. 4a, that the envelope has a fast increase in amplitude followed by a slower decrease. However, to check if the chosen parameters are suitable or not for the susceptibility analysis, it is more practical to observe the transient EMI in the frequency domain. Figure 4b shows that, effectively, the transient EMI magnitude spectrum is centered around $F = 868.3$ MHz. Besides, the magnitude presents a variation of less than 1 dB within the LoRaWAN EU863-870 band, meaning that the EMI can potentially have the same impact on all LoRaWAN channels. This avoids biased test results due to the choice of a particular LoRaWAN channel.

B. Interval between transients

Once we define one single transient waveform, we create a sequence by concatenating several waveforms in the time domain. These transients can be either regularly or irregularly spaced in time. We have already compared the effects of these two types of sequence in [3]. In the present work, we adopt irregular intervals between transients, because they are more similar to the real transients measured on-board trains [2].

Even though we generate sequences with random intervals, we ensure an average interval between transients of 10 μ s. This value is realistic in view of the measurements reported in [2].

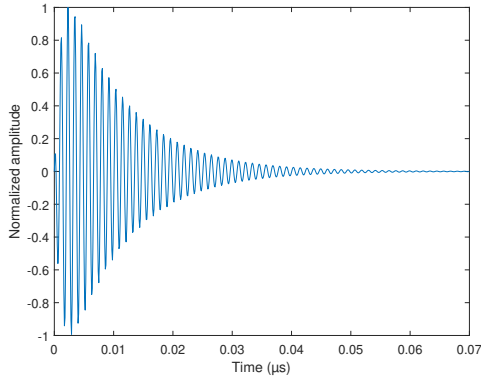

(a)

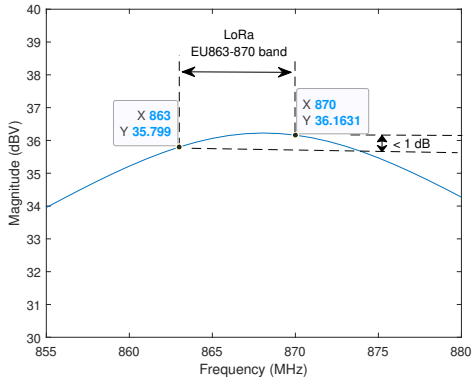

(b)

Fig. 4: One single transient, with $RT = 1$ ns, $TD = 10$ ns, and $F = 868.3$ MHz. (a) Time domain. (b) Frequency domain.

C. Total length of the sequence

Finally, the last characteristic to define is the total duration of the transient EMI sequence. This parameter plays an important role when the interval between transients is irregular. In this case, the resulting spectrum is not homogeneous. This spectrum becomes more homogeneous (“flatter”) when we increase the total duration of the sequence. Therefore, the longer the sequence is, the closer we are to the flat spectrum of Fig. 4b.

To illustrate that, let us analyze Fig. 5. This figure contains two measurements performed with the peak detector of a spectrum analyzer. The spectrum analyzer was configured with a resolution bandwidth of 130 kHz and a 1 ms sweep. With these parameters, we try to mimic a commercial LoRaWAN radio receiver. However, we use a higher sampling rate when compared to a commercial LoRaWAN radio receiver. In a practical application, low sampling rates are applied, and the transient pulse shown in Fig. 4a may be distorted. One of these measurements corresponds to a short transient EMI sequence comprising 5 transients within a $50 \mu\text{s}$ -duration window, while the other one corresponds to a long sequence comprising 50 transients within a $500 \mu\text{s}$ -duration window. In both cases, the average interval between transients is $10 \mu\text{s}$. We can see

that, while the power oscillations between adjacent frequencies are as high as 5 dB for the short sequence, it reduces to approximately 1 dB for long sequence. Therefore, the long sequences are less sensitive to the choice of a particular communication channel for the test.

V. EXPERIMENTAL RESULTS

A. General considerations

In this section, we present the results of our experimental susceptibility analysis in terms of critical SIR levels. The susceptibility to short and long transient EMI sequences is discussed separately. For each case, we run 10 times the same experiment in order to facilitate the identification of patterns or tendencies. Results are then classified into three categories: temporary loss of communication, permanent loss of communication and communication not lost.

We define temporary loss of communication as the situation where the gateway stops sending ACK messages to the LoRa transceiver but, after a certain time, the ACK signals reappear. In some of our tests, we noticed that the message exchange between the gateway and LoRa transceiver was promptly reestablished after the loss of one single ACK message. In other cases, however, the reestablishment of the LoRaWAN communication took longer with the LoRa transceiver sending multiple join requests with no reply from the gateway. In the worst cases, the communication was completely lost for a few minutes, with neither uplinks nor ACKs. All these cases are classified as *temporary loss of communication*.

If, after a few minutes, the communication between the gateway and LoRa transceiver is not re-established, we stop the test and classify the test results in the following category: *permanent loss of communication*. Finally, if we achieve the maximum severity level of the test (*i.e.* the minimum SIR) with the available test equipment and the communication is still working, then we classify the test results in the following category: *communication not lost*.

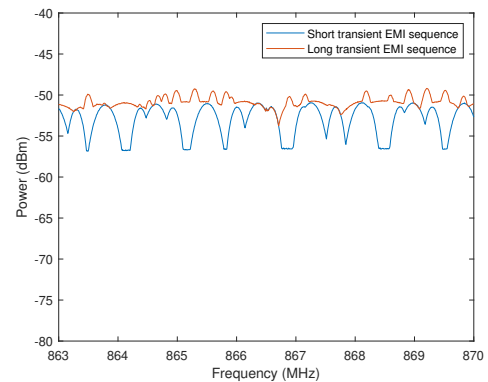

Fig. 5: Power spectra of transient EMI sequences with different durations and an average interval between transients of $10 \mu\text{s}$, obtained with a peak detector. Resolution bandwidth: 130 kHz. Sweep: 1 ms.

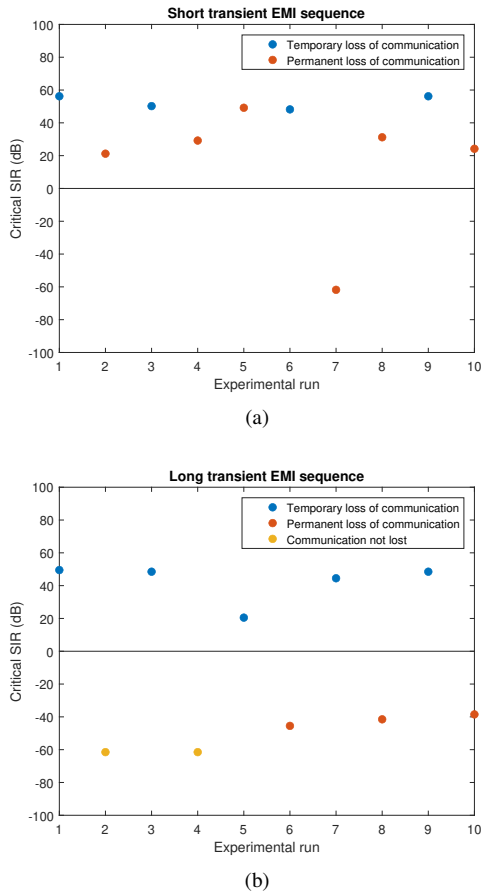

Fig. 6: Susceptibility levels of a LoRaWAN communication system operating at 868.3 MHz with a SF = 12 and a CR = 4/8 in response to (a) short and (b) long transient EMI sequences with an average interval between transients of 10 μ s.

B. Short transient EMI sequences

Figure 6a shows the critical SIR levels of a LoRaWAN communication system operating at 868.3 MHz with a SF = 12 and a CR = 4/8 when submitted to transient EMI. The interference consists of a short transient EMI sequence comprising 5 transients within a 50 μ s-duration window which is continuously generated to disturb the LoRaWAN system.

An analysis of Fig. 6a reveals that, among the 10 critical SIR values obtained, only one is negative. It means that relatively small EMI power levels were sufficient to affect the LoRaWAN communication in most cases. In other words, the LoRaWAN system showed to be sensitive to short transient EMI sequences. The critical SIR levels are distributed around 40 dB, similarly to our previous work [3].

Furthermore, the way the LoRaWAN system reacted to the interference changed from one experimental run to another. In some cases, the communication was temporarily lost, then it was recovered and, finally, it was permanently lost. This can be visualized in Fig. 6a, whenever a blue dot (temporary loss of communication) is followed by a red dot (permanent loss of communication). However, in some experimental runs, the

temporary loss of communication was not observed. In these cases, the communication was permanently lost a certain time after the beginning of the test. This is the case of the 5th and the 8th experimental run in Fig. 6a.

C. Long transient EMI sequences

The increase of the transient EMI sequence duration do not significantly affect the temporary loss of communication, which happens when the SIR is around 40 dB. However, the permanent loss of communication is now verified for smaller SIR levels, around -40 dB. Besides, the communication was not lost in 2 among the 10 experimental runs. This condition was not observed in the previous analyses involving the short transient EMI sequences. All these behaviors indicate a better robustness of the LoRaWAN system face to the transient EMI compared to the previous tests with the short sequence.

D. Interpreting the results

A comparison between Figs. 6a and 6b reveals that the LoRaWAN system seems to be more sensitive to short-duration transient EMI sequences. We observed that the spectrum of the short-duration transient EMI sequence is not homogenous in frequency in the LoRa Channels. Such behavior affects the signal-to-noise ratio (SNR) and the received signal strength indication (RSSI) calculations made by the gateway. So, our hypothesis is that due to the abrupt SNR and RSSI variations and these values do not stabilize, the gateway interrupts the communication. This would explain that critical SIR levels are higher when the transient EMI sequence is short than when the transient EMI sequence is long.

To better understand the different levels of critical SIR for the same experiment, a higher amount of experimental runs combined with statistical analysis is necessary. However, this is out of the scope of the present contribution.

VI. CONCLUSIONS

In this work, we described a complete framework to design transient EMI sequences. Such sequences can in turn be incorporated to susceptibility test procedures focused on railway wireless communication systems. In order to evaluate the proposed methodology, we run bench tests based on the LoRaWAN technology, which has recently been adopted by railway industry.

Among the many parameters related to the transient EMI sequences, we focused our attention on the length. Indeed, defining this parameter is a challenge. On one hand, long transient EMI sequences have a more homogeneous energy distribution in the frequency domain compared to the short sequences. This characteristic is pertinent for a test procedure because it allows the choice of an arbitrary communication channel. On the other hand, signal generators have memory constraints which impose a maximum sequence length. Therefore, a trade-off must be established.

Experimental results confirm that the length of the transient EMI sequence plays a role in the communication reliability. A LoRaWAN system operating at 868.3 MHz with a SF = 12

and a CR = 4/8 showed to be more sensitive to short transient EMI sequences. Critical SIR levels are close to 50 dB in this case while reaching much lower levels close to -50 dB for long transient EMI sequences. Therefore, the length of the transient EMI sequence must be well-designed in order to avoid unrealistic test results.

REFERENCES

- [1] M. Pous, M. A. Azpúrua, and F. Silva, "Measurement and evaluation techniques to estimate the degradation produced by the radiated transients interference to the gsm system," *IEEE Transactions on Electromagnetic Compatibility*, vol. 57, no. 6, pp. 1382–1390, 2015.
- [2] G. Boschetti, A. Mariscotti, and V. Deniau, "Assessment of the gsm-r susceptibility to repetitive transient disturbance," *Measurement*, vol. 45, no. 9, pp. 2226–2236, 2012.
- [3] A. N. de São José, N. Chopinet, E. P. Simon, A. Boé, T. Vantroys, C. Gransart, and V. Deniau, "A comparative analysis of lora and lorawan in the presence of jammers and transient interference," in *2022 International Symposium on Electromagnetic Compatibility – EMC Europe, 2022*, pp. 586–591.
- [4] "RP002-1.0.3 LoRaWAN Regional Parameters," LoRa Alliance, Standard, May 2021.
- [5] U. Paoletti, "Direction finding technique based on poynting vector magnitude for pantograph arcing," in *2019 International Symposium on Electromagnetic Compatibility - EMC EUROPE, 2019*, pp. 556–561.
- [6] L. Ma, A. Marvin, E. Karadimou, R. Armstrong, and Y. Wen, "An experimental programme to determine the feasibility of using a reverberation chamber to measure the total power radiated by an arcing pantograph," in *2014 International Symposium on Electromagnetic Compatibility, 2014*, pp. 269–273.
- [7] G. Gao, X. Yan, Z. Yang, W. Wei, Y. Hu, and G. Wu, "Pantograph–catenary arcing detection based on electromagnetic radiation," *IEEE Transactions on Electromagnetic Compatibility*, vol. 61, no. 4, pp. 983–989, 2019.
- [8] O. Kerfin, M. Schwarz, and R. Geise, "Arbitrary waveform generators and software-defined radio for the synthesis of non-continuous wave emc-test signals," in *2017 International Symposium on Electromagnetic Compatibility - EMC EUROPE, 2017*, pp. 1–5.