



HAL
open science

A continuous spatial and temporal mathematical model for assessing the distribution of dengue in Brazil with control

Fernando Luiz Pio dos Santos, Mostafa Bendahmane, Elmahdi Erraji, Fahd Karami

► To cite this version:

Fernando Luiz Pio dos Santos, Mostafa Bendahmane, Elmahdi Erraji, Fahd Karami. A continuous spatial and temporal mathematical model for assessing the distribution of dengue in Brazil with control. *Journal of Biological Systems*, 2023, 31 (02), pp.345-373. 10.1142/S0218339023300026 . hal-04127091

HAL Id: hal-04127091

<https://hal.science/hal-04127091>

Submitted on 13 Jun 2023

HAL is a multi-disciplinary open access archive for the deposit and dissemination of scientific research documents, whether they are published or not. The documents may come from teaching and research institutions in France or abroad, or from public or private research centers.

L'archive ouverte pluridisciplinaire **HAL**, est destinée au dépôt et à la diffusion de documents scientifiques de niveau recherche, publiés ou non, émanant des établissements d'enseignement et de recherche français ou étrangers, des laboratoires publics ou privés.

A CONTINUOUS SPATIAL AND TEMPORAL MATHEMATICAL MODEL FOR ASSESSING THE DISTRIBUTION OF DENGUE IN BRAZIL WITH CONTROL

FERNANDO LUIZ PIO DOS SANTOS *

*Institute of Biosciences of Botucatu (IBB), São Paulo State University (UNESP),
18618-970, Botucatu-SP, Brazil,
fernando.pio@unesp.br
http://www.ibb.unesp.br*

MOSTAFA BENDAHDANE

*Institut de Mathématique de Bordeaux (IMB) et l'institut de Rythmologie et Modélisation Cardiaque (Liry)
Bordeaux, Université de Bordeaux, INRIA-Carmen Bordeaux Sud-Ouest, France
mostafa.bendahmane@u-bordeaux.fr*

ELMAHDI ERRAJI

*Ecole Supérieure de Technologie d'Essaouira, Université Cadi Ayyad,
Essaouira, B.P. 383 Essaouira El Jadida, Morocco
erraji0elmahdi@gmail.com*

FAHD KARAMI

*Ecole Supérieure de Technologie d'Essaouira, Université Cadi Ayyad,
Essaouira, B.P. 383 Essaouira El Jadida, Morocco
fa.karami@uca.ma*

Received (Day Month Year)

Accepted (Day Month Year)

In this paper, we developed an optimal control of a reaction-diffusion mathematical model, describing the spatial spread of dengue infection. Compartments for human and vector populations are considered in the model, including a compartment for the aquatic phase of mosquitoes. This enabled us to discuss the vertical transmission effects on the spread of the disease in a two-dimensional domain, using demographic data for different scenarios. The model was analyzed, establishing the existence and convergence of the weak solution for the model. The convergence of the numerical scheme to the weak solution was proved. For numerical approximation, we adopted the finite element scheme to solve direct and adjoint state systems. We also used the nonlinear gradient descent method to solve the optimal control problem, where the optimal management of government investment was proposed and leads to more effective dengue fever infection control. These results may help to understand the complex dynamics driven by dengue and assess the public health policies in the control of the disease.

Keywords: Epidemic Model; Reaction-Diffusion System; Aedes; Optimal Control.

*Corresponding author.

1. Introduction

Dengue disease is a major public health problem worldwide, especially in tropical and subtropical countries such as Brazil, where it has increased in recent years. Preventions and mechanisms of controlling it may reduce the fatalities to less than 1%.¹ The World Health Organization (WHO) states that about 100 million people have been infected in more than 100 countries from all continents and many people die as a consequence of dengue.¹ It is a viral infection^{2,3} febrile disease caused by a virus of the family Flaviridae, transmitted by female mosquito bites, usually of the genus *Aedes aegypti*.

There are four distinct serotypes of the dengue virus, DENV1 - DEN4, and any of these can cause distinct severities: dengue fever (DF), in the classical form and dengue hemorrhagic fever (DHF), in the most severe case, causing serious illnesses and death among children and elderly. In infants, for example, the number of DHF cases has been increasing over the last years, In infants, for example, the number of DHF cases has increased in recent years. A mathematical modeling of DHF in infants can be seen in Ref. 4.

Humans are the main host of the virus. The dengue virus circulating in the blood of infected humans is ingested by female mosquitoes during feeding. The virus infects a mosquito and it may spread over a period of 8–12 days. After this incubation period, influenced by environmental conditions, especially temperature, the virus can be transmitted to other humans during subsequent feeding and the mosquito remains infectious for the rest of its life.^{1,5}

The first fundamental contribution to the mathematical epidemiology was introduced by Bernoulli to analyze the mortality caused by smallpox.⁶ The modern study of the epidemiological phenomenon began with a study proposed by Ross, in Ref. 7, describing an epidemic model for malaria. Then, generalization occurred with Kermack and McKendrick, see Ref. 8 for more details. The progress of applied mathematical modeling in epidemiology ranges from research using simple epidemiological models or classical models to the most sophisticated, incorporating, for example, the class of a vector that causes disease and interactions with a host. It is worth mentioning the most famous vector-borne disease model introduced by Macdonald et al., Ref. 9, in 1957 that combines Ross's model with epidemiological and entomological data to describe malaria transmission.¹⁰

In the case of the dengue problem, we can mention the model described in Ref. 11. In this paper, the authors consider infected, susceptible and recovered human populations, as well as populations of susceptible and recovered vectors. In our case study, we append a compartment for mosquitoes in the aquatic phase. The spatial dynamic is also described in the Ref. 12. The authors introduced a nonlocal and time delay model based on the fact that mosquitoes can continue to move freely in the environment.

Aedes aegypti eggs are extremely resistant to the dry season. Therefore, in cases where there are conditions favorable to their development, the eradication may be considered impossible. Therefore, efficient mechanisms need to be found to control the disease, reducing the transmitting mosquito population. The possibilities of controlling the dengue transmitter mosquito most commonly used are: mechanical control and chemical control.¹³ The mechanical control, also known as the physical control, essentially consists of the action

of removing or cleaning containers with clean water to prevent the development of *Aedes aegypti* eggs into the adult form of the mosquito.

This action is taken by public health agents and should also be carried out by residents. Chemical control is carried out using insecticides in regions with an outbreak of dengue. In this case, the vectors acquire resistance to the insecticides over time,¹⁴ increasing the dose of chemicals to be effective in mosquito control and, consequently, increasing the costs of the control.

As an alternative, biological control can be used by inserting living organisms into the environment. In particular, this can be done by inserting sterile male mosquitoes by radiation into endemic regions, expecting that mating with fertile female transmitters will not generate a new population of transmitting mosquitoes, as described in Refs. 15, 16. However, this alternative alone is not effective in controlling dengue infection.^{17,18} In order to control the mosquito population that causes the transmission of infection, there are biochemical products, for example biodiesel by-products (see for e.g. Ref. 19 for more details).

Due to the co-circulation of these different serotypes, the development of a vaccine, as a preventive control strategy, that is effective and durable for the four types of dengue serotypes has been a big challenge. In terms of costs, the coexistence of multi serotypes may causes enormous additional economic costs, as related in Refs. 20.

In Refs. 21, the authors states that vaccination in seropositive individuals reduced the risk of hospitalizations. Therefore, he vaccine may be an economically viable control strategy, since an infected individual can: (i) reduce the workforce, (ii) increase public costs for treatment, and (iii) DHF cause high economic costs, due to the severe symptoms. However, as there is still no effective and durable vaccine providing immunity to all different serotypes, this imperfect vaccine can give a false sense of protection.²² In this case, there are serious risks of increases in dengue outbreaks.²⁰

Therefore, the vaccination strategy alone is not enough to control the disease and minimize the associated costs. In the absence of effective and efficient vaccines, propagation can only be done by controlling the population of *Aedes*.

Improvements in hygiene and in basic sanitation are not being enough to control the disease, making it one of the biggest challenges in the world. Despite this, knowledge about the development of new tools and strategies that lead to improvements and progress in dengue prevention is very important, necessary and still far from ideal.⁵

In the observational study described in Ref. 23 is shown the epidemiological situation of dengue in Brazil in the last three decades, by using data of dengue notifications of the National Surveillance System from 1990 to 2017. In this study, the authors affirmed that “dengue incidence increased in all Brazilian regions and the interepidemic periods are distinct in the different regions”.

In this context, we pay particular attention to the question of how to obtain an optimized investment to reduce the number of cases of dengue infection in an affected area of a tropical region, particularly in Brazil.

A multi-objective approach to optimal control dengue transmission was introduced in Ref. 17, that aims to find the most effective ways of controlling the disease. We mention the

work in Ref. 24 who established a cost function describing an infected population regarding medical treatment and educational sanitation campaigns.

The focus of our study was to investigate the impact of human motivation to reduce the mature and aquatic phase of mosquito populations on the dispersal of the vector population, and the impact of vector dispersal behavior on the spread of disease. We also studied an optimal control over a large geographic region regarding only the education and sanitation campaigns in the mosquito compartment in order to analyze the dynamics of both mosquito and human populations.

We aimed to understand how the disease spreads from a specific location to another, considering the diffusion coefficients of both infected populations (mosquitoes and humans). To do this, we proposed an optimal control strategy to decrease the human infected population acting on the mature and aquatic phase population. We also aimed to solve the optimization problem using the available data in Brazil, in order to illustrate the reality of disease spreading. Our contribution provides an in-depth analysis of the optimal control problem and it outlines a more explicit modeling framework based on real spatial-temporal data.

In particular, we offer spatially distributed optimal investment during the outbreak that can help, for example, decision-makers in choosing the best investment strategy to combat dengue, taking into account the characteristics of each of the five regions, of the Federative Republic of Brazil. We compared the focus of the control between the whole vector population and aquatic phase population to draw conclusions on the investment effect in each case.

This paper is organized as follows: in Section 2, we begin by discussing the epidemiological model taking into account the spatial dynamics of the species and control. In Section 3 we perform the numerical simulations, illustrating the infection spreading using real data under constant control and optimal control on the vector population. In the Appendices (A.1), we show the numerical scheme proposed to solve the reaction-diffusion model. We also investigate the existence and convergence of the weak solution of the optimal control problem. Additional numerical results of dengue dynamics were presented. Finally, we conclude this paper by making a comparison between the optimal control in the aquatic phase and the whole vector population.

2. Model Description

In our mathematical model we took into account the interaction between the dengue mosquito and human populations. We also considered the circulation of a single serotype of dengue, for both mosquito populations, susceptible and infected. Since we are not considering the data of the external infected population, we assumed no ongoing immigration of infected humans. The influence of seasonality (rainfall and temperature) on the mosquito population level is considered here via the entomological parameters varying with the temperature (see Refs. 25, 26).

2.1. Dengue Mathematical Model

The populations involved in the epidemiological dynamics proposed in this study are susceptible and infected for humans, as well as for mosquitoes. Herein, H_s and H_I are the density of human susceptible and infected populations. We denote by M_s and M_I the density of adult susceptible and infected mosquito populations, respectively, while A presents the density of mosquitoes in the aquatic phase (eggs and larvae). Moreover, the control ν describes the human motivation to combat mosquitoes.

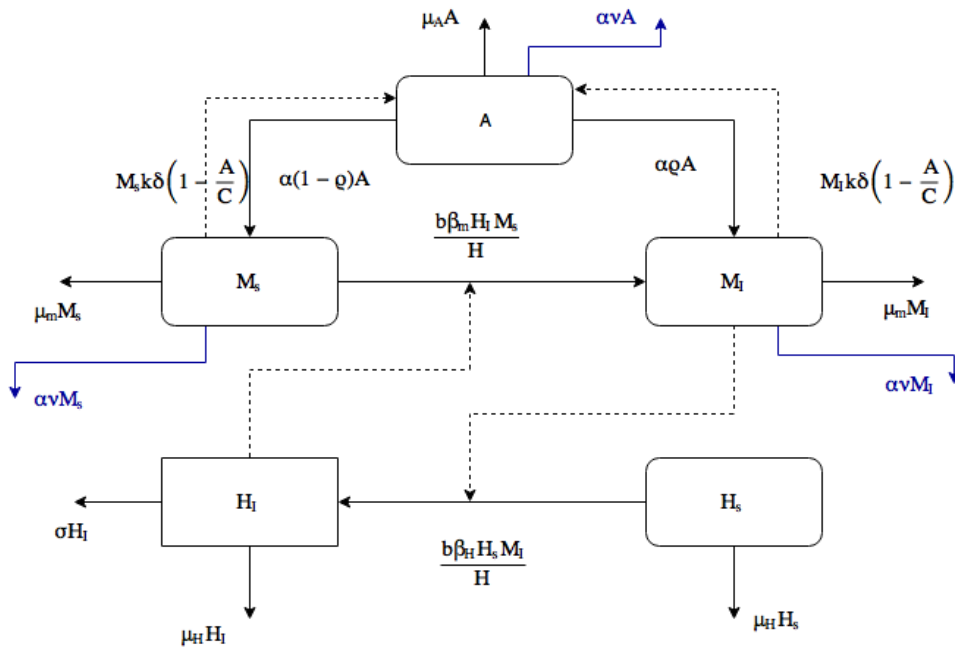

Fig. 1. Compartmental diagram representing population dynamics of human (H), mosquito (M), aquatic phase (A) and mosquito–human interactions.

Figure 1 illustrates all compartments for the aquatic phase, mosquito and human populations separated into two compartments, susceptible and infected populations with their interactions.

The susceptible mosquito, usually the female *Aedes*, can become infected if it bites a human infected with dengue.²⁷ Thus, in regions infected by *Aedes*, the transmission of dengue to the population of susceptible humans occurs through the bite of the infected mosquito *Aedes*. Note that the human-mosquito interaction is mathematically expressed as the variation of the infected mosquitoes, positively proportional to the product of the infected human population to the susceptible mosquito population, normalized by the total population of humans. Likewise, we consider that the population variation of infected humans is proportional to the product of the human population susceptible to the infected

mosquito population, also normalized by the total population of humans. The mosquitoes in the aquatic phase can give rise to a small proportion of infected mosquitoes by the dengue virus, through the phenomenon known as vertical transmission.²⁸

The local characteristics are expressed via parameters of the transmission model of disease and invasion by *Aedes aegypti*, Tables (1) and (2), respectively.

Table 1. Parameters of *Aedes aegypti* transmission.

| | | |
|-----------|---|-------------------------|
| H | Human populations (susceptible, infected and recovered) | $indiv. \times km^{-2}$ |
| M | Mosquito populations (susceptible and infected) | $indiv. \times km^{-2}$ |
| σ | Recovery rate of humans | day^{-1} |
| μ_H | Mortality rate of human population | $year^{-1}$ |
| b | Proportion of the effective bite that transmits infection | day^{-1} |
| β_H | Probability of vector transmission to humans | — |
| β_m | Probability of human transmission to the vector | — |

Table 2. Parameters related to the *Aedes aegypti* invasion.

| | | |
|--------------|---|-------------------------|
| C | Carrying capacity of aquatic phase of mosquitoes | $indiv. \times km^{-2}$ |
| k | Ratio between male and female mosquitoes | — |
| δ | Per-capita oviposition rate | day^{-1} |
| μ_A | Mortality rate of aquatic stages of mosquitoes | day^{-1} |
| μ_m | Mortality rate of adult mosquito populations | day^{-1} |
| α | Transformation rate of water phase to the adult phase | day^{-1} |
| ϵ_M | Diffusion coefficient of mosquitoes | $km^2 \times day^{-1}$ |
| D_H | Diffusion coefficient of humans | $km^2 \times day^{-1}$ |

Assuming all assumptions above, we propose the following bidimensional Reaction-Diffusion dengue model:

$$\begin{cases} \partial_t M_I &= \epsilon_M \Delta M_I + f^{M_I}(M_I, H_I, A, M_s, H_s) - \alpha \nu M_I & \text{in } \Omega_T := (0, T) \times \Omega, \\ \partial_t H_I &= D_H \Delta H_I + f^{H_I}(M_I, H_I, A, M_s, H_s) & \text{in } \Omega_T, \\ \partial_t A &= f^A(M_I, H_I, A, M_s, H_s) - \alpha \nu A & \text{in } \Omega_T, \\ \partial_t M_s &= \epsilon_M \Delta M_s + f^{M_s}(M_I, H_I, A, M_s, H_s) - \alpha \nu M_s & \text{in } \Omega_T, \\ \partial_t H_s &= D_H \Delta H_s + f^{H_s}(M_I, H_I, A, M_s, H_s) & \text{in } \Omega_T, \\ \nabla M_I \cdot \eta &= 0, \nabla H_I \cdot \eta = 0, \nabla M_s \cdot \eta = 0, \nabla H_s \cdot \eta = 0 & \text{on } \Sigma_T = (0, T) \times \partial\Omega \\ M_I(0) &= M_{I,0}, H_I(0) = H_{I,0}, A(0) = A_0, M_s(0) = M_{s,0}, H_s(0) = H_{s,0} & \text{in } \Omega, \end{cases} \quad (2.1)$$

where $\epsilon_M \Delta M_i$ and $D_H \Delta H_j$ are the diffusive fluxes, for $i = S, I$ and $j = S, I, R$, with ϵ_M and D_H denoting the diffusion coefficients of mosquitoes and humans, respectively. Δ and $\nabla = \vec{x} \frac{\partial}{\partial x} + \vec{y} \frac{\partial}{\partial y}$ are the Lapacian and gradient operators in the x and y directions in Cartesian coordinate system, respectively. Moreover, we denote by $\eta(x, y)$ the normal vector on $\partial\Omega$. The parameter ν (*indiv.* $\times km^{-2}$) represents the control applied to the mosquito population in the aquatic phase. The interaction terms are written as follows:

$$\begin{aligned} f^{M_I}(M_I, H_I, A, M_s, H_s) &:= \alpha A - \mu_m M_I + \frac{b\beta_m M_s H_I}{H} \\ f^{H_I}(M_I, H_I, A, M_s, H_s) &:= \frac{b\beta_H H_s M_I}{H} - \mu_H H_I - \sigma H_I \\ f^A(M_I, H_I, A, M_s, H_s) &:= k\delta \left(1 - \frac{A}{C}\right) (M_s + M_I) - (\mu_A + \alpha) A \\ f^{M_s}(M_I, H_I, A, M_s, H_s) &:= \alpha(1 - \rho) A - \mu_m M_s - \frac{b\beta_m M_s H_I}{H} \\ f^{H_s}(M_I, H_I, A, M_s, H_s) &:= \mu_H (H - H_s) - \frac{b\beta_H H_s M_I}{H} \end{aligned}$$

The temperature can affect transmission dynamics, influencing rates of development and mortality of immature mosquitoes, as well as the number of eggs deposited. As described in Ref. 29, the entomological parameters can be established in the modeling according to local characteristics, for example, by varying with temperature, as shown in Table 3.

The dependence of the ovipositional rate on the temperature can be modeled considering the values of ovipositions published in Ref. 25, making it possible to define different scenarios in relation to the temperature, at different temperatures. In addition, environmental carrying capacity and mosquito mortality rates may vary, depending on local rainfall and temperature. Herein, the spatial domain of Brazil is given by a bounded open set $\Omega \subset \mathbb{R}^2$ with a piecewise smooth boundary $\partial\Omega$. The coefficients $D_H > 0$ and $\epsilon_M > 0$ are the diffusion for human and mosquito populations, respectively, with $D_H > \epsilon_M$. For the boundary condition on the brazilian coast, we are assuming null flux. Concerning the continental borders of the country, we consider a neglected immigration from the human and mosquito population, i.e. we consider a homogeneous *Neumann* boundary conditions.

Table 3. Entomological parameters varying with the temperature.^{25,26}

| $^{\circ}C$ | δ | μ_A | μ_m | α |
|-------------|----------|---------|---------|----------|
| 15 | 0.66 | 0.038 | 0.02 | 0.019 |
| 25 | 6.353 | 0.061 | 0.033 | 0.423 |
| 27 | 7.741 | 0.071 | 0.03 | 0.45 |
| 30 | 8.916 | 0.098 | 0.029 | 0.58 |
| 32 | 8.622 | 0.123 | 0.038 | 0.726 |

2.2. Control Model

Due to the *Aedes aegypti* egg resistance to dry seasons, eradication is still far from becoming a reality in areas where the conditions are favorable for the development of mosquitoes in adult form. Therefore, we studied the optimal the effectiveness of population motivation on infection reduction. Here, we target the population behavioral activities to combat mosquitoes, in order to study the effectiveness of the target population motivation effect to reduce the infected population density.

The *Aedes aegypti* mosquito can be found in tropical and sub-tropical climates worldwide living in urban areas in breeding sites such as containers. One of the main complications of dengue disease is the fact that there are four distinct serotypes of dengue virus (DENV 1–DENV 4). After the primary infection of one serotype of dengue virus, the secondary infection may develop a lethal complication called Dengue Hemorrhagic Fever (DHF).³⁰ DHF causes serious illnesses and death among children in some Asian and Latin American countries.¹

In terms of costs, it is clear that the occurrence of at least two different serotypes causes enormous additional economic costs, as described in Refs 20, in which the vaccination strategy alone is not enough to control the disease, as well as minimizing the associated costs.

Our model (2.1) describes the spatio-temporal dynamics of the involved population in the epidemic scenario on a global scale. Here, we introduce a global strategy to reduce infection of the human population in large geographical regions.

It is convenient to assume the control as a social action to prevent Aedes breeding sites, promoting conditions unfavourable to breeding of vectors in their habitats, e.g, making sure that all tanks, water deposits and containers are covered and sealed to keep out mosquitoes. Despite this, the success of this action strongly depends on the government’s investment, e.g, in educational campaigns.

Now, let the control function ν be governed by the following Ordinary Differential Equation, based on Refs. 24, 31, where one can see more details and discussions:

$$\frac{d}{dt}\nu(t, x) = -\tau_1\nu(t, x) + \tau_2(t, x), \quad (2.2)$$

where we are denoting $x = (x_1, x_2) \subset \Omega$ and $t \geq 0$. Also, $-\tau_1$ (day^{-1}) and τ_2 ($value \times day^{-1}$) mean the forgetting rate to promote conditions unfavourable to Aedes breeding and the government’s investment in the combat against Aedes, respectively. The expression

$-\tau_1\nu(t, x)$, $(t, x) \in \Omega$ represents the decaying of the control effect, due to forgetfulness in combating the reproductive mosquito life cycle.

Next Section, we described the optimal control framework for the dengue model.

2.3. Dengue Optimal Control Model

In this Subsection, the existence of the control, the complete optimality system and the existence of the Lagrange multipliers are shown.³²

First, we provide the existence of the solution for the optimal control problem of the dengue model. Let us consider the following spatial problem for the optimization of our model:

$$(P) \quad \left\{ \begin{array}{l} \min_{\tau_2} \left[J(\tau_2) = \frac{1}{2} \left(\iint_{\Omega_T} (\varepsilon_1 |H_I - H_{I,d}|^2 + \varepsilon_2 |\tau_2|^2) dx dt \right) \right], \\ \text{subject to the reaction-diffusion system (2.1),} \end{array} \right. \quad (2.3)$$

where $J(\tau_2)$ is the cost function related to τ_2 . Here ε_1 and ε_2 are the regularization parameters. The main idea is to compute the optimized control that minimizes the cost function and makes the population of infected humans, H_I , as small as possible over time. In Section 3, we intend to observe the desired state of the infected human $H_{I,d}$ closer to 0, as solutions of the optimization problem (P).

The cost function, J , will be used in the following lemma concerning the existence of an optimal solution for (2.3).

Lemma 2.1 *Given $\mathbf{u}_0 = (M_{I,0}, H_{I,0}, A_0, M_{s,0}, H_{s,0}) \in L^2(\Omega, \mathbb{R}^5)$ and $H_{I,d} \in L^2(\Omega_T)$, there is a solution τ_2^* of the optimal control dengue problem (2.3).*

Proof: For the sequence $(\mathbf{u}_n)_n = (M_I^n, H_I^n, A^n, M_s^n, H_s^n, \tau_2^n)_n$, let $(\tau_2^n)_n$ be a minimizing sequence. Since J is bounded, we deduce from the definition of J that

$$\iint_{\Omega_T} |\tau_2^n(t, x)|^2 dx dt \leq C,$$

for some constant $C > 0$. Using this, Theorem Appendix A.1 and A.10, we deduce the following convergence (upon a subsequence):

$$(M_I^n, H_I^n, M_s^n, H_s^n) \rightarrow (M_I, H_I, M_s, H_s) \text{ strongly in } L^2(\Omega_T) \text{ and a.e. in } \Omega_T, \quad (2.4)$$

$$(M_I^n, H_I^n, M_s^n, H_s^n) \rightharpoonup (M_I, H_I, M_s, H_s) \text{ weakly in } L^2(0, T; H^1(\Omega, \mathbb{R}^4)). \quad (2.5)$$

$$A^n \rightharpoonup A \quad \text{weakly in } L^2(\Omega_T), \quad (2.6)$$

With this convergence, we deduce easily:

$$\min_{\tau_2} J(\tau_2) \leq J(\tau_2^*) \leq \liminf_{n \rightarrow \infty} J(\tau_2^n) = \min_{\tau_2} J(\tau_2).$$

This implies finally that τ_2^* is an optimal control solution to the problem (2.3). This concludes the proof of Lemma 2.1.

10 *dos Santos, Bendahmane, Erraji and Karami*

Now, we derive the optimality conditions based on the Lagrangian formulation which is defined as follows:

$$\begin{aligned}
 L(\theta) = & \iint_{\Omega_T} \frac{\varepsilon_1}{2} |H_I(t, x)|^2 dx dt + \iint_{\Omega_T} \frac{\varepsilon_2}{2} |\tau_2(t, x)|^2 dx dt + \iint_{\Omega_T} \partial_t M_I p_{M_I} dx dt \\
 & + \iint_{\Omega_T} \partial_t H_I p_{H_I} dx dt + \iint_{\Omega_T} \partial_t A p_A dx dt + \iint_{\Omega_T} \partial_t M_s p_{M_s} dx dt \\
 & + \iint_{\Omega_T} \partial_t H_s p_{H_s} dx dt - \sum_{i \in I} \iint_{\Omega_T} f^i(M_I, H_I, A, M_s, H_s) p_i dx dt \\
 & + \varepsilon_{M_I} \iint_{\Omega_T} \nabla M_I \cdot \nabla p_{M_I} dx dt + \varepsilon_{M_s} \iint_{\Omega_T} \nabla M_s \cdot \nabla p_{M_s} dx dt \quad (2.7) \\
 & + D_{H_I} \iint_{\Omega_T} \nabla H_I \cdot \nabla p_{H_I} dx dt + D_{H_s} \iint_{\Omega_T} \nabla H_s \cdot \nabla p_{H_s} dx dt \\
 & + \iint_{\Omega_T} (\alpha \nu M_I p_{M_I} + \alpha \nu A p_A + \alpha \nu M_s p_{M_s}) dx dt \\
 & + \iint_{\Omega_T} (\partial_t \nu + \tau_1 \nu - \tau_2) p_\nu dx dt.
 \end{aligned}$$

where $\theta = (M_I, H_I, M_s, H_s, A, \nu, \tau_2, p_{M_I}, p_{H_I}, p_{M_s}, p_{H_s}, p_A, p_\nu)$ and $I = \{M_I, H_I, A, M_s, H_s\}$. The first order optimality system characterizing the adjoint variables is given by the Lagrange multipliers which result from equating the partial derivatives of L , with respect to M_I, H_I, M_s, H_s, A and ν equal to zero:

$$\left\{ \begin{array}{l}
 -\partial_t p_{M_I} - \varepsilon_{M_I} \Delta p_{M_I} = \sum_{i \in I} f_{M_I}^i(\mathbf{u}^h) p_i - \alpha \nu p_{M_I} \quad \text{in } \Omega_T, \\
 -\partial_t p_{H_I} - D_{H_I} \Delta p_{H_I} = \sum_{i \in I} f_{H_I}^i(\mathbf{u}^h) p_i - \varepsilon_1 H_I \quad \text{in } \Omega_T, \\
 -\partial_t p_A = \sum_{i \in I} f_A^i(\mathbf{u}^h) p_i - \alpha \nu p_A \quad \text{in } \Omega_T, \\
 -\partial_t p_{M_s} - \varepsilon_{M_s} \Delta p_{M_s} = \sum_{i \in I} f_{M_s}^i(\mathbf{u}^h) p_i - \alpha \nu p_{M_s} \quad \text{in } \Omega_T, \\
 -\partial_t p_{H_s} - D_{H_s} \Delta p_{H_s} = \sum_{i \in I} f_{H_s}^i(\mathbf{u}^h) p_i \quad \text{in } \Omega_T,
 \end{array} \right. \quad (2.8)$$

where f_i^j is the derivative of f^j with respect to i for each $i, j \in I = \{M_I, H_I, A, M_s, H_s\}$. We complete system (2.8) with the following conditions (boundary and final time conditions):

$$\left\{ \begin{array}{l}
 \mathbf{p}(\mathbf{T}, \cdot) = \mathbf{p}_T(\cdot) = \mathbf{0} \quad \text{in } \Omega, \\
 \nabla \mathbf{p} \cdot \boldsymbol{\eta} = \mathbf{0} \quad \text{on } \Sigma_T,
 \end{array} \right. \quad (2.9)$$

for $\mathbf{p} = p_{M_I}, p_{H_I}, p_{M_s}, p_{H_s}, p_A, p_\nu$. Note that to find the optimal conditions, we calculate the gradient of the functional $J(\tau_2)$:

$$\left(\frac{\partial L}{\partial \tau_2}, \delta \tau_2 \right) = \iint_{\Omega_T} (\varepsilon_2 \tau_2(t, x) - p_\nu(t, x)) \delta \tau_2 dx dt \quad \text{and} \quad \nabla J(H_I, \tau_2) = \frac{\partial L}{\partial \tau_2}.$$

Observe that the optimality condition can be written as follows

$$\nabla J(H_I, \tau_2) = 0 \Rightarrow \iint_{\Omega_T} (\varepsilon_2 \tau_2(t, x) - p_\nu(t, x)) dx dt = 0. \quad (2.10)$$

Now, we define the following solution operator:

$\mathcal{A} : L^2(\Omega_T) \rightarrow L^2(0, T, H^1(\Omega, \mathbb{R}^5))$, by $(M_I, H_I, A, M_s, H_s) = S(\tau_2)$ for $\tau_2 \in L^2(\Omega_T)$ and (M_I, H_I, A, M_s, H_s) is the solution to (2.1). Note that the control dengue system (2.1) together with the initial data $\mathbf{u}_0 \in L^2(\Omega, \mathbb{R}^5)$, the existence of the weak solution (M_I, H_I, A, M_s, H_s) is guaranteed for any feasible control $\tau_2 \in L^2(\Omega_T)$ by Theorem Appendix A.1. Therefore, we have the following proposition.

2.1 Control to state map *The control to state mapping*

$$\tau_2 \rightarrow (M_I, H_I, A, M_s, H_s)$$

is well defined for the problem: (2.8)-(2.9).

Now we have the following result where the proof is similar to Theorem (Appendix A.1).

2.2 First order necessary optimality conditions *Let $\mathbf{u}^* = (M_I^*, H_I^*, A^*, M_s^*, H_s^*)$ be a local solution to the control dengue system (2.1). Then, there is a unique Lagrange multiplier $\mathbf{p}^* = (p_{M_I}^*, p_{H_I}^*, p_{M_s}^*, p_{H_s}^*, p_A^*, p_\nu^*)$ in $L^2(0, T, H^1(\Omega, \mathbb{R}^5)) \times C([0, T], L^2(\Omega))$ such that the pair $(p_{M_I}^*, p_{H_I}^*, p_{M_s}^*, p_{H_s}^*, p_A^*, p_\nu^*)$ is a weak solution to the adjoint equations (2.8)-(2.9). Moreover, the optimality condition (2.10) holds for almost all $t \in [0, T]$.*

3. Computational Simulations

In this section, we investigate the simulation output of the numerical methods described above. We start by illustrating the evolution of infected humans with respect to various governmental investments. Next, we explain the resolution steps of the optimization problem, described in (8). Finally, we present the optimal control solution according to spatial epidemiological data in Brazil.

3.1. Numerical results of the primal problem

Here, we implement the numerical schemes defined in Appendix (A.1).^{33,34} First, we choose different values of governmental investment τ_2 in the direct problem to investigate its influence on the infected population.

In Figure 2, we present the mosquito mortality ($\mu_m(x)$) and transformation rate from the aquatic to mature phase ($\alpha(x)$) in a gray-scale map based on statistics from Brazil issued by the Ministry of Health.³⁵ Moreover, we plot the susceptible human distribution throughout Brazil. The remaining parameters are taken as shown in Table (4)-(5). For the spatial dynamics of human and mosquito populations, we chose classical diffusion. In the absence of data to indicate the real proportion of mosquitoes per humans by regions, we assume $\frac{M(0)}{H(0)} = 2$, as described in Ref. 36, considering $H_s(0) = H(0) - H_I(0) =$ and $M_s(0) = M(0) - M_I(0)$. We intend to include in future works this heterogeneity in the modeling, carrying out a careful study in order to determine the correct proportion for each region of Brazil Tables (4) and (5) show all the biological parameters used for the numerical simulations.

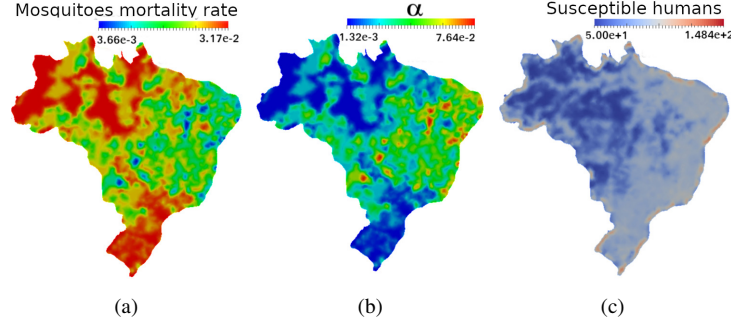

Fig. 2. Brazil's map and distributions of the data. (a) The mosquito population mortality; (b) The transformation from aquatic to mature phase and (c) Susceptible humans initial distributions, to be considered for μ_m , α and $H_s(0)$, respectively.

Table 4. Biological parameters for the numerical simulations (days⁻¹).

| | | | | | | |
|-----|-----------|-----------|-------------|--------------|----------|--------|
| C | μ_A | μ_H | μ_m | δ | σ | b |
| 13 | 0.0583 | 0.0457 | Figure 2(a) | 6.353 | 0.96 | 1.0 |
| k | β_H | β_m | α | ϵ_M | D_H | ρ |
| 0.5 | 1.0 | 1.0 | Figure 2(b) | 0.005 | 0.007 | 0.01 |

Table 5. Initial conditions.

| | | | | | | |
|----------|----------|--------|----------|-------------|----------|-------------|
| $M_I(0)$ | $H_I(0)$ | $A(0)$ | $M_S(0)$ | $H_S(0)$ | $\nu(0)$ | $\tau_2(0)$ |
| 1.0 | 0.0 | 0.0 | 200.0 | Figure 2(c) | 0.05 | 0.004 |

In order to obtain a realistic epidemiological behavior of the spread of dengue infection in Brazil, we use the real geometry of Brazil's map as a computational domain in model (2.1). We also extracted the distribution of mortality and birth rates of the vector population from dengue risk distribution in 2008.³⁵

First, we simulated the dynamics of the spread of dengue considering the absence of any strategy of control. Figure 3 shows the sequences of numerical results for populations of infected humans and susceptible mosquitoes in Brazil, when there was no government intervention, i.e., $\tau_2 = 0.0$.

These results are qualitatively similar to those obtained in 2015 and 2016, where the outbreaks were recorded in 2015, with 1,688,688 cases, as noted in.²³

The computational results in Figure 4 show the spatial distribution of dengue disease in the epidemiological scenario described by the discretized model (2.1) and Eq. (2.2). Using different values of governmental investment, we plot the corresponding results of the infected population.

Figures 4(a), 4(c) and 4(e) present the dynamics of infected humans at time $t = 200$ and using $\tau_2 = 0.0$, $\tau_2 = 5.0$ and $\tau_2 = 14.1$, respectively. Figures 4(b), 4(d) and 4(f)

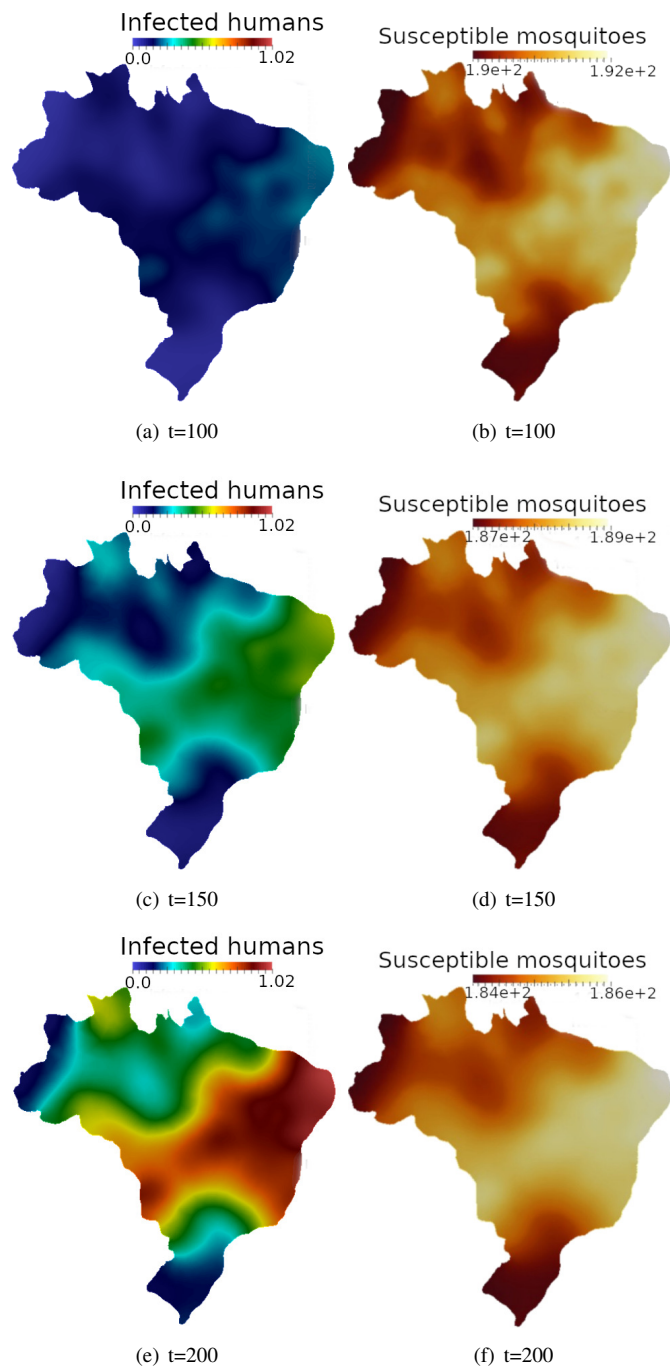

Fig. 3. Numerical results of infected human and susceptible mosquito spatial distribution of densities using the arbitrary values $\tau_1 = 0.1$ and $\tau_2 = 0.0$.

14 *dos Santos, Bendahmane, Erraji and Karami*

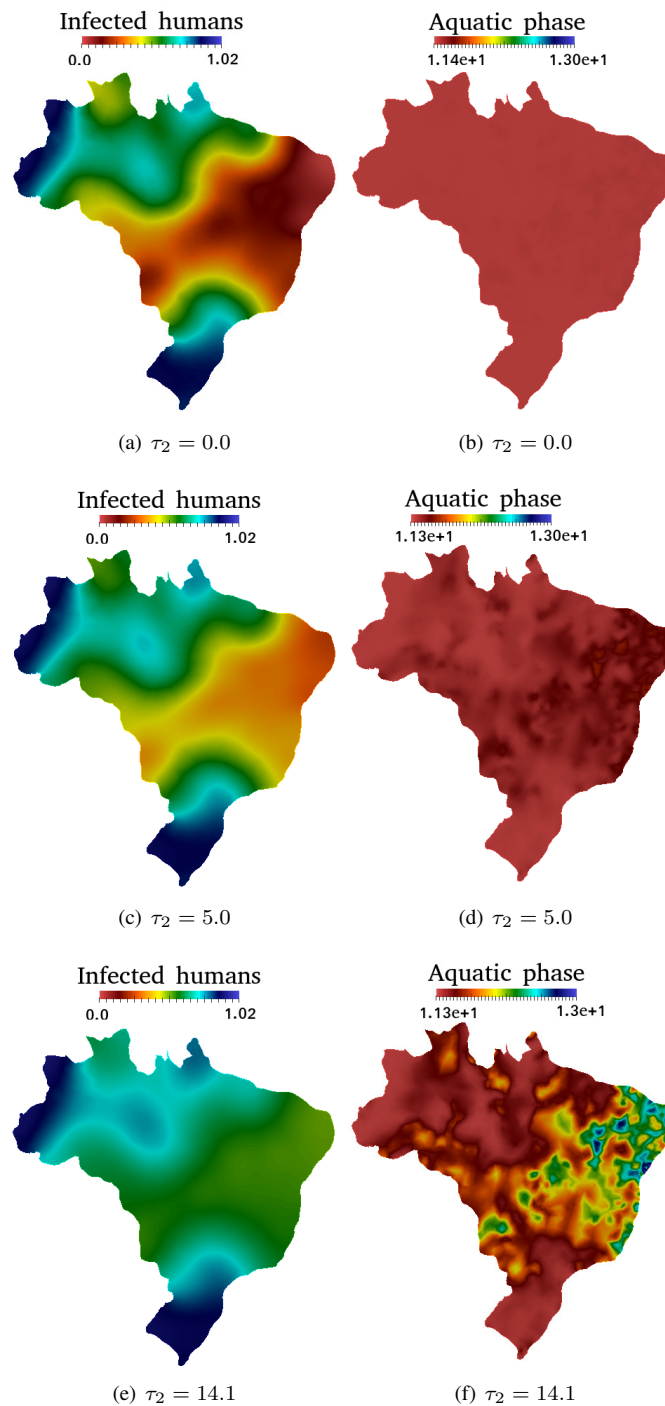

Fig. 4. Numerical results of the two-dimensional spatial distribution of the population densities varying the values for τ_2 in the model (2.1). The left and right side figures correspond to densities of the infected human population and the aquatic phase, respectively. Parameters for the numerical simulation: $\tau_1 = 0.1$ fixed and $T = 200$ days.

show the corresponding aquatic phase distribution at time $t = 200$. From these results, one can observe that in normal circumstances the dynamics of the infected population rises in endemic areas in Brazil (Central-West).

Comparing the numerical results shown in the sequences of Figures 4(a), 4(c) and 4(e), it can be observed that the infected population decreases when the governmental investment values increase. In addition, the South and North of Brazil show lower growth in terms of dengue infection.

These results strongly agree with the new *Rapid Assessment Survey for Aedes aegypti* (LIRAA), which indicates 357 Brazilian municipalities at risk of dengue outbreak, Zika and Chikungunya. Based on the last LIRAA bulletin, the northeastern region had the highest number of probable cases in relation to the total number of probable cases of dengue in the country (239,076 probable cases in November 2017), presenting 84,051 cases (35.2%). The Central-West, Southeast, North and South regions presented 74,691 cases (31.2%), 55,381 cases, (23.2%), 21,057 cases (8.8%) and 3,896 cases (1.6%), respectively.³⁷

Brazil has a diverse climate due to several factors, e.g., natural relief of the terrain and territorial extension. The Northern area of Brazil includes most of the Amazon basin. The Amazon region is notoriously humid, with high annual precipitation. Moreover, the Amazon has the largest rainforest in the world.

In the South, the annual average temperatures range from 14°C to 22°C. In winter and summer, the maximum and minimum rainfall ratios are recorded, respectively. These conditions are not favorable for dengue mosquito growth.³⁸ In agreement with this, we present the numerical results shown in Figure 4(e), where the density of infected humans in both these areas is less than the others.

Despite this result, using a time-space constant investment, $\tau_2 = 14.1$, may lead to unsatisfying results. In the next Section, we will investigate the optimal control for the dengue model, as the previous analysis described in Section 2.3.

3.2. Minimization Algorithm

We established the optimal control strategy for the problem. In a finite element framework, we divided the map of Brazil into several parts (South (S), Northeast (NE), Northwest (NW), Central-West (CW) and Southeast (SE)). Consequently, we define the investment parameter $\tau_2(t, x)$ as follows:

$$\begin{aligned} \tau_2(t, x) = & \tau_2^S(t) \mathbf{1}_{\Omega_S}(x) + \tau_2^{NE}(t) \mathbf{1}_{\Omega_{NE}}(x) + \tau_2^{NW}(t) \mathbf{1}_{\Omega_{NW}}(x) \\ & + \tau_2^{CW}(t) \mathbf{1}_{\Omega_{CW}}(x) + \tau_2^{SE}(t) \mathbf{1}_{\Omega_{SE}}(x), \end{aligned}$$

where $\tau_2^i > 0$ is the governmental investment in Ω_i for $i = S, NE, NW, CW, SE$ and $\mathbf{1}$ is the indicator function. To implement the optimal control, we developed an algorithm with all the computational requirements to ensure the global convergent. For this, a nonlinear conjugate gradient method is considered in the algorithm based on the Hager and Zhang, in Ref. 39. In order to investigate the optimal investment in each area of Brazil, we followed the procedure of minimization, as described in Algorithm 3.1.

Algorithm 3.1 The procedure of minimization to solve the optimal control problem.

```

1: Input:  $M_{I,0}, H_{I,0}, A_0, M_{s,0}, H_{s,0}, \nu_0, err \leftarrow 1$ 
2: Initialize:  $\tau_2^0, \alpha, tol, k \leftarrow 0$ 
3:
4: while  $\|\nabla J(\tau_2^k)\| > tol$  do
5:   for  $t = t^1, \dots, t^{final}$  do
6:     Giving  $\tau_2^k$  Compute  $M_I^h, H_I^h, A^h, M_s^h, H_s^h$  from the direct problem;
7:   end for
8:   Compute the cost function  $J(\tau_2^k, H_I)$ 
9:   for  $t = t^{final}, \dots, t^0$  do
10:    Giving  $\tau_2^k, M_I^h, M_s^h, H_I^h, H_s^h$  and  $A^h$ , compute  $p_{M_I}^h, p_{H_I}^h, p_A^h, p_{M_s}^h, p_{H_s}^h$ 
    by solving the adjoint problem;
11:   end for
12:   Compute the gradient  $g_{k+1} = \nabla J(\tau_2^k, p_\nu^h)$ ;
13:   Compute  $y_k = g_{k+1} - g_k$ 
14:   Compute step length  $\alpha_k$ 
15:   Update the values of  $\tau_2$   $\tau_2^{k+1} = \tau_2^k + \alpha_k d_k$ ;
16:   Compute  $\beta^k = (y_k - 2d_k \frac{\|y_k\|^2}{d_k^T y_k})^T \frac{g_{k+1}}{d_k^T y_k}$ 
17:    $d_k = -g_k + \beta^k d_{k-1}$ ;
18:   Update the direction  $d_k = g_k + \beta^k d_{k-1}$ 
19:    $k \leftarrow k + 1$ 
20: end while

```

3.3. Numerical Results of the Optimal Control Problem

In this section, we aim to obtain an optimal governmental investment, τ_2 , in order to reduce the spread of dengue fever in Brazil. We provide a comparative study between the dynamics of infected population scenarios.

The reduction of infection in the domain, shown in the Figures 5(a), 5(c) and 5(e), is induced by the reduction of the vector population in the critical regions, as shown in Figures 5(b), 5(d) and 5(f).

We observed in the controlled case that the susceptible mosquito population can be found in targeted areas (Northeast, Southeast, Central-West). The spatial distribution densities of infected mosquito can be see in Appendix B.

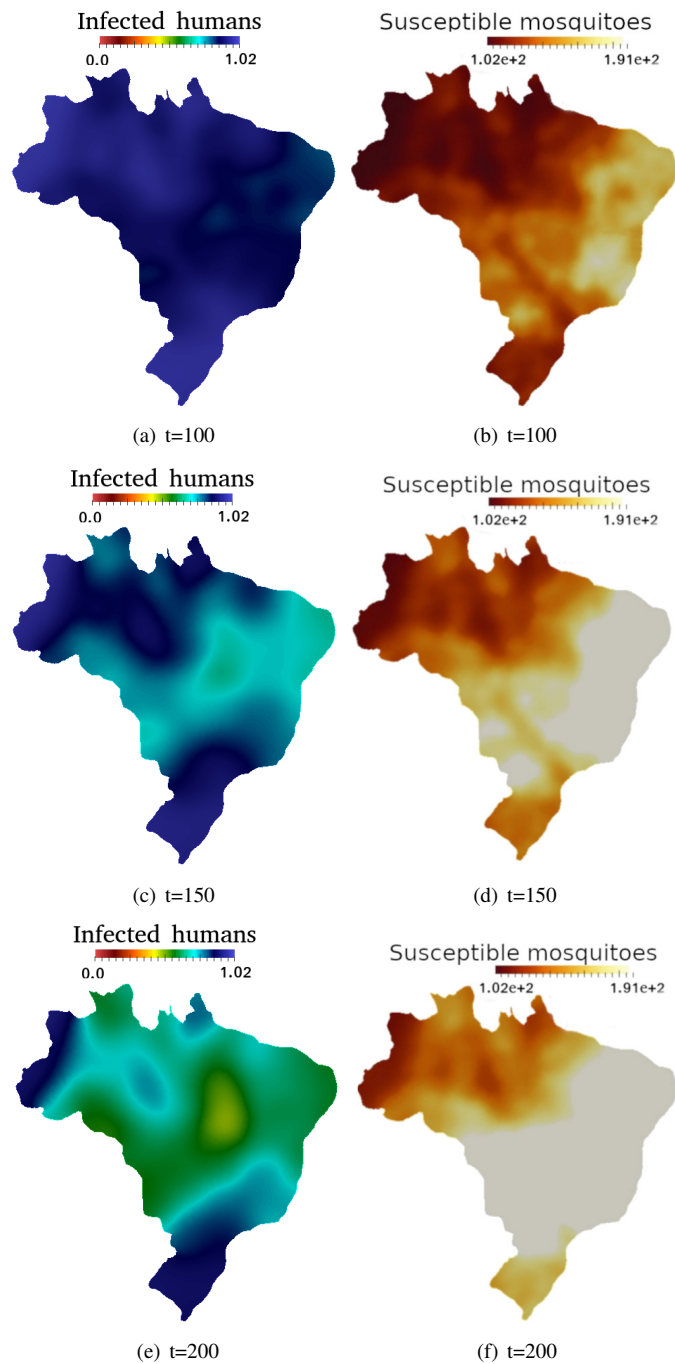

Fig. 5. Spatial distribution of the densities of the infected human and the susceptible mosquito populations applying the optimal control solution for the optimal $\tau_2(t)$, with $\tau_1 = 0.1$.

3.4. Cost Function and Optimal Investment

We also investigate the infected population dynamics considering the optimal control applying in two different cases: 1. on the total of the mosquito population and 2. on the aquatic phase. For example, in Figure 6 we have a larger controlled infected population in the first case (Figure 6(b)) than in the second case (Figure 6(a)).

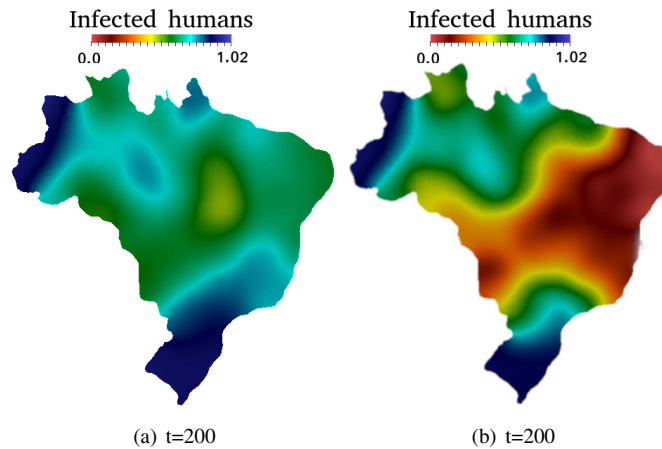

Fig. 6. Comparison of infected human population distribution applying the control in the cases: (a) on the total mosquito population and (b) on aquatic phase.

We observe that the iterative process described previously in Algorithm 3.1 leads to the optimal value of investment. In Figure 7, we depict the optimal control on human infection acting only in the aquatic phase of the mosquitoes. In Figure 8, the optimal control was applied in the aquatic phase, susceptible and infected populations.

During iterations of the optimization strategy, we describe the cost function values, as illustrated in Figure 8(a). We compute the gradient norm at each iteration. Figure 8(b) shows a decreasing value of the gradient norm with precision 10^{-13} . Figure 8(c) presents the optimal governmental investment over time. The corresponding minimum value of the cost function is set to 3500. In this case, the optimal solution is better compared to its counterpart in Figure 7.

In the Central-West, Northeast and Southeast the investment must maintain larger values. A reasonable investment in these areas must occur in order to lessen the infection, which may relieve the transmission in epidemiologically active regions.

It can be concluded that the government investment should be intense in the middle of the epidemiological period as a preventive dengue control. Otherwise, the densities of infected humans may grow, if the government investment decrease. This is strongly corroborated with Refs 38, where affirm that particular attention must be paid to the issue of “sustainability” of dengue vector control strategies, which should be maintained, monitored and with an “affordable cost”.

To illustrate this fact, a similar behavior was appointed by Refs 22, where the authors confirmed the hypothesis that populations affected by dengue tend to relax vector control habits, if a vaccine is available. The authors also stated that the likely dengue vaccine may not be 100% effective. This fact can cause a false sense of perfect protection and, therefore, its introduction can increase the intensity of transmission.

20 *dos Santos, Bendahmane, Erraji and Karami*

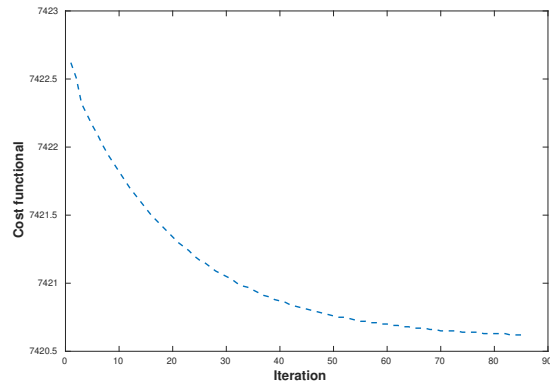

(a) $J(\tau_2)$

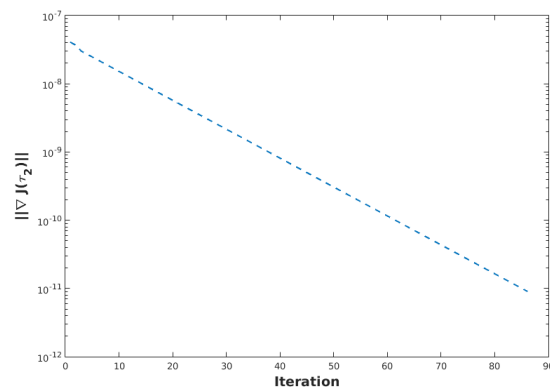

(b) $\nabla J(\tau_2)$

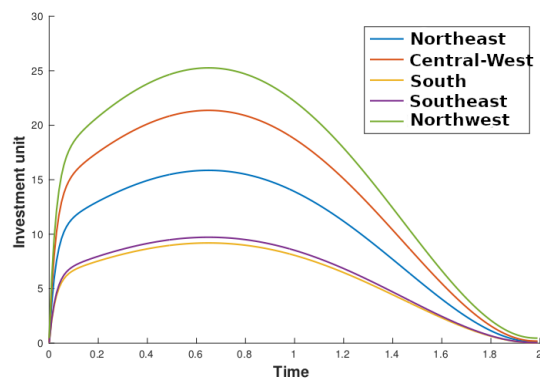

(c) τ_2

Fig. 7. Computational aspects of the Algorithm (3.1) applied only on the aquatic phase: (a) The optimal solution for τ_2 ; (b) The gradient norm, $\nabla J(\tau_2)$, at each iteration; (c) Cost function, $J(\tau_2)$, evolution during the iterations.

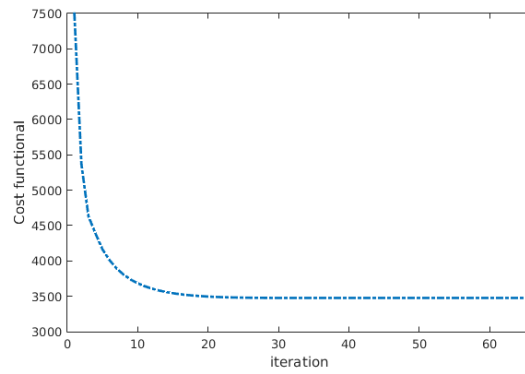

(a) $J(\tau_2)$

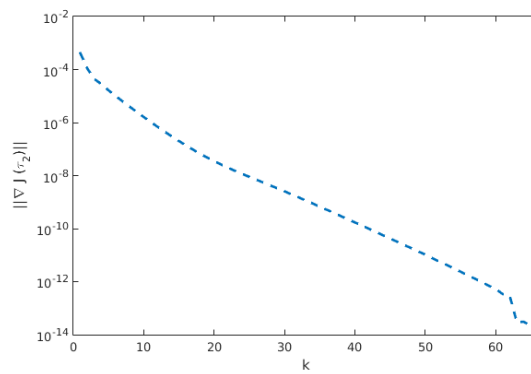

(b) $\nabla J(\tau_2)$

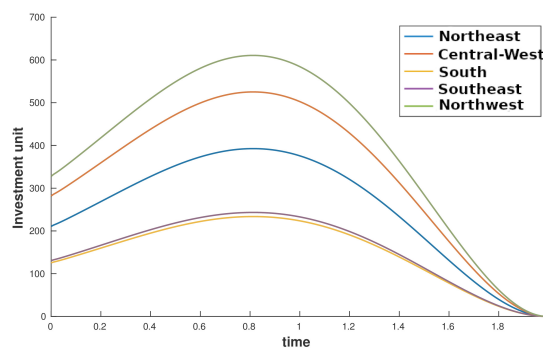

(c) τ_2

Fig. 8. Computational aspects of the Algorithm (3.1) applied on the susceptible and infected populations, and also on the aquatic phase: (a) The optimal solution for τ_2 ; (b) The gradient norm, $\nabla J(\tau_2)$, at each iteration; (c) Cost function, $J(\tau_2)$, evolution during the iterations.

Based on the previous analysis and results, we may recommend the optimal management as the most accurate solution for the government investment in terms of dengue control and also for the infection detraction. Next Section, we draw the main conclusions of this analytical and numerical investigation on the dengue disease problem.

4. Conclusions

The dynamics of human-mosquito interaction in the dengue problem involves many complexities. In the present work, we developed an optimal control for a spatial model to identify the most accurate optimal strategy to curtail the spread of the dengue infection in Brazil, where the incidence continues to increase.

We proposed a numerical scheme in order to approximate the optimal control model and we have investigated the convergence of the finite element scheme to the weak solution.

To obtain realistic epidemiological results of the spread, we solved the optimal problem considering data of dengue disease in Brazil. The optimal control solutions was proposed for different regions of Brazil, where the optimal management of government investment leads to more accurate results, in terms of dengue fever infection detraction. However, further studies should be undertaken to improve the results, especially in the diffusion phenomenon in the context of dengue.

Therefore, the main conclusions that can be drawn are the following:

- (1) The dynamic of the infected population rises in endemic areas in Brazil's Central-West region;
- (2) The infection is higher in the Central-West, Northeast and Southeast of Brazil than in the North and South, in agreement with the data;
- (3) In order to optimize the infection, we strongly suggest maintaining the control during the epidemic period in the Central-West, Northeast and Southeast regions of the country;
- (4) In the presence of control, our results show that the infected population decreases when the governmental investment values are increased.

In summary, this research may help to understand the complicated dynamics driven by tropical diseases, and in the generation of knowledge for the implementation of public health policies in the control of dengue.

Acknowledgments

FLPS thank the São Paulo Research Foundation (FAPESP), grant 2018/03116-3. M.B., E.E. and F.K. thank the CNRST (Morocco), project "Modèles Mathématiques appliquées l'environnement, à l'imagerie médicale et aux biosystèmes"

References

1. World Health Organization, Dengue: guidelines for diagnosis, treatment, prevention and control, World Health Organization, 2009.

2. McBride WJ, Bielefeldt-Ohmann H, Dengue viral infections; pathogenesis and epidemiology, *Microbes and infection* 2 (9): pp. 1041–1050, 2000.
3. Halstead SB, Dengue, *The lancet* 370 (9599), pp. 1644–1652, 2007.
4. Camargo FA, Oliveira TM, Rodrigues DS, Mancera PFA, Santos FLP, A Mathematical Model for Assessing Dengue Hemorrhagic Fever in Infants. *Trends in Computational and Applied Mathematics*, 23 (1), 101-115, 2022. DOI: 10.5540/tcam.2022.023.01.00101
5. Teixeira MG, Costa MdCN, Barreto F, Barreto ML, Dengue: twenty-five years since reemergence in Brazil, *Cadernos de saúde pública* 25: pp. S7–S18, 2009.
6. Bernoulli D, Essai d'une nouvelle analyse de la mortalité causée par la petite vérole, et des avantages de l'inoculation pour la prévenir, *Histoire de l'Acad., Roy. Sci.(Paris) avec Mem*, pp. 1–45, 1760.
7. Ross R, Report on the Prevention of Malaria in Cyprus, January 1914, Wyman and Sons, 1914.
8. Kermack WO, McKendrick AG, A contribution to the mathematical theory of epidemics, *Proceedings of the royal society of London. Series A, Containing papers of a mathematical and physical character*, 115 (772): pp. 700–721, 1927.
9. G. Macdonald, *The Epidemiology and Control of Malaria*, Oxford Univeristy Press, New York, 1957.
10. Lal S, Dhillon GPS, Aggarwal CS, Epidemiology and control of malaria, *Indian J Pediatr*, 66: pp. 547–554, 1999.
11. Derouich M, Boutayeb A, Twizell E, A model of dengue fever, *BioMedical Engineering OnLine*, 2 (1) 4: 2003.
12. Lin HI, Wang FB, On a reaction–diffusion system modeling the dengue transmission with non-local infections and crowding effects, *Applied Mathematics and Computation*, 248: pp. 184–194, 2014.
13. Governo do Estado de São Paulo - Secretaria de Estado da Saúde, Superintendência em controle de endemias, normas e orientações técnicas para vigilância e controle de *Aedes aegypti*, Tech. rep., [Online; Accessed on February 08, 2022] 2008.
14. Kuniyoshi MLG, dos Santos FLP, Mathematical modelling of vector-borne diseases and insecticide resistance evolution, *Journal of Venomous Animals and Toxins including Tropical Diseases*, 23 (1) 34: 2017.
15. Thomé RC, Yang HM, Esteva L, Optimal control of aedes aegypti mosquitoes by the sterile insect technique and insecticide, *Mathematical Biosciences*, 223 (1): pp. 12–23, 2010.
16. Esteva L, Yang HM, Mathematical model to assess the control of aedes aegypti mosquitoes by the sterile insect technique, *Mathematical Biosciences*, 198 (2), pp. 132–147, 2005.
17. Florentino HO, Cantane DR, dos Santos FLP, Bannwart BF, Multiobjective genetic algorithm applied to dengue control, *Mathematical Biosciences*, 258: pp. 77–84, 2014.
18. Florentino HO, Cantane DR, dos Santos FLP, Reis CA, Pato MMGV, Jones D, Oliveira RA, Lyra LG. Genetic algorithm for optimization of the Aedes aegypti control strategies. *Pesquisa Operacional (online)*, 38, pp. 389-411, 2018.
19. Pant M, Dubey SS, Naik SN, Patanjali PK, Utilization of biodiesel by-products for mosquito control, *Journal of Bioscience and Bioengineering*, 121 (3): pp. 299–302, 2016.
20. Chudej K, Fischer A, Optimal Vaccination Strategies for a new Dengue Model with two Serotypes. *IFAC Papers OnLine* 51 (2), 13-18, 2018.
21. Kurauchi A, Shimozako HJ, Massad E, Analysis of the Impact of Vaccination as Control Strategy of Dengue Transmission Dynamics Considering a Multi-Strain Model. *Journal of Vaccines, Immunology and Immunopathology*, JV11-134, 2018.
22. Boccia TMQR, Burattini MN, Coutinho FAB, Massad E, Will people change their vector-control practices in the presence of an imperfect dengue vaccine? *Epidemiology & Infection*, 142 (3), 625-633, 2014.
23. Andrioli DC, Busato MA, Lutinski JA, Spatial and temporal distribution of dengue in Brazil,

24 *dos Santos, Bendahmane, Erraji and Karami*

- 1990 - 2017. PLoS ONE, 15(2): e0228346, 2020.
24. Rodrigues HS, Monteiro MTT, Torres DF, Dynamics of dengue epidemics when using optimal control, *Mathematical and Computer Modelling*, 52 (9-10): pp. 1667–1673, 2010.
 25. Yang HM, da Graça Macoris MdL, Galvani KC, Andrighetti MTM, Follow up estimation of aedes aegypti entomological parameters and mathematical modellings, *Biosystems* 103 (3): pp 360–371, 2011.
 26. Takahashi LT, Maidana NA, Ferreira WC, Pulino P, Yang HM, Mathematical models for the aedes aegypti dispersal dynamics: travelling waves by wing and wind, *Bulletin of Mathematical Biology*, 67 (3): pp. 509–528, 2005.
 27. Adams B, Kapan DD, Man bites mosquito: understanding the contribution of human movement to vector-borne disease dynamics, *PloS one*, 4 (8), e6763, 2009.
 28. Ferreira-de Lima VH, Lima-Camara TN, Natural vertical transmission of dengue virus in aedes aegypti and aedes albopictus: a systematic review, *Parasites & vectors*, 11 (1), 77, 2018.
 29. Esteva L, Yang HM, Assessing the effects of temperature and dengue virus load on dengue transmission, *Journal of Biological Systems*, 23 (04), 1550027, 2015.
 30. Adimy M, Mancera PFA, Rodrigues DS, dos Santos FLP, Ferreira CP. Maternal passive immunity and dengue hemorrhagic fever in infants. *Bulletin of Mathematical Biology*, 82, pp. 24, 2020.
 31. Silva LRG, dos Santos FLP, Predição numérica do controle mecânico na dinâmica populacional dos mosquitos da dengue, *Revista Brasileira de Biometria*, 36 (2): pp. 316–335, 2018.
 32. Bendahmane M, Chamakuri N, Numerical analysis for an optimal control of bidomain-bath model, *Journal of Differential Equations*, 263 (5): pp. 2419–2456, 2017.
 33. Temam R, Navier-Stokes equations: theory and numerical analysis, *American Mathematical Soc.*, 343: 2001.
 34. Brezis H, Ciarlet PG, Lions JL, *Analyse fonctionnelle: théorie et applications*, Dunod Paris, 91, 1999.
 35. Brazil Mds, Programa nacional de controle da dengue, secretaria de vigilância em saúde. *Informe epidemiológico de dengue janeiro a junho de 2008*, Tech. rep., [Online; Accessed on February 08, 2022], 2008.
 36. Le Menach A, McKenzie FE, Flahault A, Smith DL, The unexpected importance of mosquito oviposition behaviour for malaria: non-productive larval habitats can be sources for malaria transmission, *Malaria Journal*, 4 (1) 23: 2005.
 37. Brazil Mds, Preventing and combating: Dengue, chikungunya and zika. *liraa aponta 357 municípios em situação de risco para dengue, zika e chikungunya*, <http://combateaedes.saude.gov.br/pt/noticias/919-liraa-aponta-357-municipios-em-situacao-de-risco-para-dengue-zika-e-chikungunya>, 03-09-2018.
 38. Heintze C, Velasco Garrido M, Kroeger A, What do community-based dengue control programmes achieve? A systematic review of published evaluations. *Transactions of the Royal Society of Tropical Medicine and Hygiene*, 101, 317-325, 2007.
 39. Hager WW, Zhang H, A new conjugate gradient method with guaranteed descent and an efficient line search, *SIAM Journal on Optimization*, 16 (1): pp. 170–192, 2005.

Appendix A. Analysis of Optimal Control Dengue Model

Here, we establish the existence and convergence of the weak solution of the control dengue model (2.1) by a discrete Galerkin approach. The convergence proof is based on deriving a series of a priori estimates and using a general L^2 -compactness criterion. Moreover, we show that our optimal control problem has a solution that we characterize using relaxation techniques to obtain the optimality system.

A.1. Existence of Weak Solution to the Primal Problem

We will use the following spaces. By $H^m(\Omega)$, we denote the usual Sobolev space of order m . Given $T > 0$ and $1 \leq p \leq \infty$, $L^p(0, T; \mathbb{R})$ denotes the space of L^p integrable functions from the interval $[0, T]$ into \mathbb{R} . Let \mathcal{T} be a regular partition of Ω into tetrahedral K with boundary ∂K and diameter h_K . We define the mesh parameter $h = \max_{K \in \mathcal{T}} \{h_K\}$ and the associated finite element space V^h , for the approximation of the population density. That is, the involved space is defined as:

$$V^h = \{s \in C^0(\bar{\Omega}) : v|_K \in \mathbb{P}_1(K) \text{ for all } K \in \mathcal{T}\}.$$

The semidiscrete Galerkin finite element formulation then reads: For $t > 0$, find $M_I^h(t), H_I^h(t), A^h(t), M_s^h(t), H_s^h(t) \in V^h$ such that (with the standard finite element notation for L^2 scalar products), one has:

$$\left\{ \begin{array}{l} \iint_{\Omega_T} \partial_t M_I^h(t) \phi_1^h dxdt + \epsilon_M \iint_{\Omega_T} \nabla M_I^h(t) \cdot \nabla \phi_1^h dxdt \\ \quad = \iint_{\Omega_T} \left(f^{M_I}(\mathbf{u}^h) - \alpha \nu^h M_I^h \right) \phi_1^h dxdt \\ \iint_{\Omega_T} \partial_t H_I^h(t) \phi_2^h dxdt + D_H \iint_{\Omega_T} \nabla H_I^h(t) \cdot \nabla \phi_2^h dxdt \\ \quad = \iint_{\Omega_T} \left(f^{H_I}(\mathbf{u}^h) \right) \phi_2^h dxdt \\ \iint_{\Omega_T} \partial_t A^h(t) \phi_3^h dxdt = \iint_{\Omega_T} \left(f^A(\mathbf{u}^h) - \alpha \nu^h A^h \right) \phi_3^h dxdt, \\ \iint_{\Omega_T} \partial_t M_s^h(t) \phi_4^h dxdt + \epsilon_M \iint_{\Omega_T} \nabla M_s^h(t) \cdot \nabla \phi_4^h dxdt \\ \quad = \iint_{\Omega_T} \left(f^{M_s}(\mathbf{u}^h) - \alpha \nu^h M_s^h \right) \phi_4^h dxdt, \\ \iint_{\Omega_T} \partial_t H_s^h(t) \phi_5^h dxdt + D_H \iint_{\Omega_T} \nabla H_s^h(t) \cdot \nabla \phi_5^h dxdt \\ \quad = \iint_{\Omega_T} f^{H_s}(\mathbf{u}^h) \phi_5^h dxdt, \end{array} \right. \quad (\text{A.1})$$

for all $\phi_i^h \in V^h$ for $i = 1, 2, 3, 4, 5$. In addition, we set $M_I^h(0) = \mathbb{P}_{V^h}(M_{I,0}), H_I^h(0) = \mathbb{P}_{V^h}(H_{I,0}), A^h(0) = \mathbb{P}_{V^h}(A_0), M^h(0) = \mathbb{P}_{V^h}(M_0)$, and $H_s^h(0) = \mathbb{P}_{V^h}(H_{s,0})$.

A classical backward Euler integration method is used for the time discretization of (A.1) with time step $\Delta t = T/N$. This results in the following fully discrete method: for $t > 0$, find $M_I^h(t), H_I^h(t), A^h(t), M_s^h(t), H_s^h(t) \in V^h$ such that:

$$\left(M_I^h, H_I^h, A^h, M_s^h, H_s^h \right)(t, \mathbf{x}) = \left(M_I^{h,n}, H_I^{h,n}, A^{h,n}, M_s^{h,n}, H_s^{h,n} \right)(\mathbf{x}) \mathbb{1}_{((n-1)\Delta t, n\Delta t]}(t),$$

26 *dos Santos, Bendahmane, Erraji and Karami*

satisfies the following system:

$$\left\{ \begin{array}{l} \left(\frac{M_I^{h,n} - M_I^{h,n-1}}{\Delta t}, \phi_1^h \right)_\Omega + \epsilon_M (\nabla M_I^{h,n}, \nabla \phi_1^h)_\Omega \\ \quad = (f^{M_I}(\mathbf{u}^{h,n}) - \alpha \nu^{n,h} M_I^{n,h}, \phi_1^h)_\Omega \\ \left(\frac{H_I^{h,n} - H_I^{h,n-1}}{\Delta t}, \phi_2^h \right)_\Omega + D_H (\nabla H_I^{h,n}, \nabla \phi_2^h)_\Omega = (f^{H_I}(\mathbf{u}^{h,n}), \phi_2^h)_\Omega \\ \left(\frac{A^{h,n} - A^{h,n-1}}{\Delta t}, \phi_3^h \right)_\Omega = (f^A(\mathbf{u}^{h,n}) - \alpha \nu^{n,h} A^{h,n}, \phi_3^h)_\Omega, \\ \left(\frac{M_s^{h,n} - M_s^{h,n-1}}{\Delta t}, \phi_4^h \right)_\Omega + \epsilon_M (\nabla M_s^{h,n}, \nabla \phi_4^h)_\Omega \\ \quad = (f^{M_s}(\mathbf{u}^{h,n}) - \alpha \nu^{n,h} M_s^{n,h}, \phi_4^h)_\Omega, \\ \left(\frac{H_s^{h,n} - H_s^{h,n-1}}{\Delta t}, \phi_5^h \right)_\Omega + D_H (\nabla H_s(t), \nabla \phi_5^h)_\Omega = (f^{H_s}(\mathbf{u}^{h,n}), \phi_5^h)_\Omega, \end{array} \right. \quad (\text{A.2})$$

for all $\phi_i^h \in V^h$ with $i = 1, \dots, 5$ and for all $n \in \{1, \dots, N\}$; the initial condition takes the form of:

$$(M_I^{h,0}, H_I^{h,0}, A^{h,0}, M_s^{h,0}, H_s^{h,0}) = (\mathbb{P}_{V^h}(M_{I,0}), \mathbb{P}_{V^h}(H_{I,0}), \mathbb{P}_{V^h}(A_0), \mathbb{P}_{V^h}(M_{s,0}), \mathbb{P}_{V^h}(H_{s,0})).$$

Before stating our main results in this section, we give the definition of a weak solution of our optimal control dengue problem (2.1).

Definition Appendix A.1 *A weak solution to dengue system (2.1) is the vector (M_I, H_I, A, M_s, H_s) such that $M_I, H_I \in L^2(0, T, H^1(\Omega))$, $\partial_t M_I, \partial_t H_I \in L^2(0, T, (H^1(\Omega)))$, $A, M_s, H_s \in C([0, T], L^2(\Omega))$, and satisfying the following weak formulation:*

$$\left\{ \begin{array}{l} \iint_{\Omega_T} \partial_t M_I(t) \phi_1 dxdt + \epsilon_M \iint_{\Omega_T} \nabla M_I(t) \cdot \nabla \phi_1 dxdt \\ \quad = \iint_{\Omega_T} (f^{M_I}(\mathbf{u}) - \alpha \nu M_I) \phi_1 dxdt \\ \iint_{\Omega_T} \partial_t H_I(t) \phi_2 dxdt + D_H \iint_{\Omega_T} \nabla H_I(t) \cdot \nabla \phi_2 dxdt = \iint_{\Omega_T} f^{H_I}(\mathbf{u}) \phi_2 dxdt \\ \iint_{\Omega_T} \partial_t A(t) \phi_3 dxdt = \iint_{\Omega_T} (f^A(\mathbf{u}) - \alpha \nu A) \phi_3 dxdt, \\ \iint_{\Omega_T} \partial_t M_s(t) \phi_4 dxdt + \epsilon_M \iint_{\Omega_T} \nabla M_s(t) \cdot \nabla \phi_4 dxdt \\ \quad = \iint_{\Omega_T} (f^{M_s}(\mathbf{u}) - \alpha \nu M_s) \phi_4 dxdt, \\ \iint_{\Omega_T} \partial_t H_s(t) \phi_5 dxdt + D_H \iint_{\Omega_T} \nabla H_s(t) \cdot \nabla \phi_5 dxdt = \iint_{\Omega_T} f^{H_s}(\mathbf{u}) \phi_5 dxdt, \end{array} \right. \quad (\text{A.3})$$

for all $\phi_1, \phi_2, \phi_4, \phi_5 \in L^2(0, T, H^1(\Omega))$ and $\phi_3 \in C([0, T], L^2(\Omega))$.

Our first result for the primal control dengue equations is as follows.

Theorem Appendix A.1 *Assume $\mathbf{u}_0 = (M_{I,0}, H_{I,0}, A_0, M_{s,0}, H_{s,0}) \in L^2(\Omega, \mathbb{R}^5)$, then the finite element solution $\mathbf{u}^{h,n} = (M_I^{h,n}, H_I^{h,n}, A^{h,n}, M_s^{h,n}, H_s^{h,n})$, generated by (A.2),*

converges along a subsequence to $\mathbf{u} = (M_I, H_I, A, M, H)$ as $h \rightarrow 0$, where \mathbf{u} is a weak solution of (2.1).

Proof sketched: First, we prove that (A.2) admits a discrete solution $\mathbf{u}_h^n = (M_I^{h,n}, H_I^{h,n}, A^{h,n}, M_s^{h,n}, H_s^{h,n})$. Let $E_h := (V_H^h)^5$ be a Hilbert space endowed with the obvious norm and $\Phi^h = (\phi_1^h, \phi_2^h, \phi_3^h, \phi_4^h, \phi_5^h) \in E_h$. We now define the mapping $\mathcal{A} : E_h \rightarrow E_h$ by

$$\begin{aligned} & [\mathcal{A}(\mathbf{u}^{h,n}), \Phi^h] \\ &= \left(\frac{M_I^{h,n} - M_I^{h,n-1}}{\Delta t}, \phi_1^h \right)_\Omega + \epsilon_{M_I} (\nabla M_I^{h,n}, \nabla \phi_1^h)_\Omega - (f^{M_I}(\mathbf{u}_h^n) - \alpha \nu^{n,h} M_I^{n,h}, \phi_1^h)_\Omega \\ &+ \left(\frac{H_I^{h,n} - H_I^{h,n-1}}{\Delta t}, \phi_2^h \right)_\Omega + D_{H_I} (\nabla M_I^{h,n}, \nabla \phi_2^h)_\Omega - (f^{H_I}(\mathbf{u}_h^n), \phi_2^h)_\Omega \\ &+ \left(\frac{A^{h,n} - A^{h,n-1}}{\Delta t}, \phi_3^h \right)_\Omega - (f^A(\mathbf{u}_h^n) - \alpha \nu^{n,h} A^{h,n}, \phi_3^h)_\Omega \\ &+ \left(\frac{M_s^{h,n} - M_s^{h,n-1}}{\Delta t}, \phi_4^h \right)_\Omega + \epsilon_{M_s} (\nabla M_s^{h,n}, \nabla \phi_4^h)_\Omega - (f^{M_s}(\mathbf{u}_h^n) - \alpha \nu^{n,h} M_s^{n,h}, \phi_4^h)_\Omega \\ &+ \left(\frac{H_s^{h,n} - H_s^{h,n-1}}{\Delta t}, \phi_5^h \right)_\Omega + D_{H_s} (\nabla H_s^{h,n}, \nabla \phi_5^h)_\Omega - (f^{H_s}(\mathbf{u}_h^n), \phi_5^h)_\Omega, \end{aligned}$$

for all $\Phi^h \in E_h$. Note that the mapping \mathcal{A} depends formally on a fixed $\mathbf{u}^{h,n-1}$. Next, it is easy to obtain the following bounds from the discrete Hölder inequality.

$$[\mathcal{A}(\mathbf{u}^{h,n}), \Phi^h] \leq C \|\mathbf{u}^{h,n}\|_{E_h} \|\Phi^h\|_{E_h},$$

for all \mathbf{u}^h and Φ^h in E_h . This implies that \mathcal{A} is continuous. Our goal now is to show that

$$[\mathcal{A}(\mathbf{u}^{h,n}), \mathbf{u}^{h,n}] > 0 \quad \text{for } \|\mathbf{u}^{h,n}\|_{E_h} = r > 0, \quad (\text{A.4})$$

for a sufficiently large r . This implies (see for e.g. Ref.³³) that there exists $\mathbf{u}^{h,n}$ such that $\mathcal{A}(\mathbf{u}^{h,n}) = 0$. We can observe that from Young and Poincaré inequalities:

$$[\mathcal{A}(\mathbf{u}^{h,n}), \mathbf{u}^{h,n}] \geq C_1(\Delta t) \|\mathbf{u}^{h,n}\|_{E_h}^2 - C_2(\Delta t) \|\mathbf{u}^{h,n-1}\|_{L^2(\Omega)}^2 + C_3. \quad (\text{A.5})$$

Then, for a given $\mathbf{u}^{h,n-1}$ we deduce from (A.5) that (A.4) holds for r large enough (recall that $\|\mathbf{u}^{h,n}\|_{E_h} = r$). Hence, we obtain the existence of at least one solution to the discrete Galerkin scheme (A.2).

Next, we establish several a priori (discrete energy) estimates, which will eventually imply the desired convergence results.

We start by proving the non-negativity of the discrete solution. To do this, we use (A.2) with $\phi_1^h = -(M_I^{h,n})^-$, $\phi_2^h = -(H_I^{h,n})^-$, $\phi_3^h = -(A^{h,n})^-$, $\phi_4^h = -(M_s^{h,n})^-$ and $\phi_5^h = -(H_s^{h,n})^-$, and we sum over $n = 1, \dots, k$ for all $1 < k \leq N$. Using discrete

28 *dos Santos, Bendahmane, Erraji and Karami*

Granwall inequality, the result is:

$$\begin{aligned} & \int_{\Omega} \left(|(M_I^{h,k})^-|^2 + |(H_I^{h,k})^-|^2 + |(A^{h,k})^-|^2 + |(M_s^{h,k})^-|^2 + |(H_s^{h,k})^-|^2 \right) dx \\ & \leq \int_{\Omega} \left(|(M_I^{h,0})^-|^2 + |(H_I^{h,0})^-|^2 + |(A^{h,0})^-|^2 + |(M_s^{h,0})^-|^2 + |(H_s^{h,0})^-|^2 \right) dx, \end{aligned} \quad (\text{A.6})$$

for all $1 < k \leq N$. Since the initial condition is non-negative, we deduce from (A.6) the non-negativity of the discrete solution \mathbf{u}^h . To obtain energy estimates, we substitute $\phi_1^h = M_I^{h,n}$, $\phi_2^h = H_I^{h,n}$, $\phi_3^h = A^{h,n}$, $\phi_4^h = M_s^{h,n}$ and $\phi_5^h = H_s^{h,n}$ in (A.2), and we sum over $n = 1, \dots, k$ for all $1 < k \leq N$. An application of Young and Gronwall inequalities yields:

$$\begin{aligned} & \|(M_I^h, H_I^h, A^h, M_s^h, H_s^h)\|_{L^\infty(0,T;L^2(\Omega,\mathbb{R}^5))} \leq C, \\ & \|\nabla M_I^h\|_{L^2(\Omega_T)} + \|\nabla H_I^h\|_{L^2(\Omega_T)} + \|\nabla M_s^h\|_{L^2(\Omega_T)} + \|\nabla H_s^h\|_{L^2(\Omega_T)} \leq C, \end{aligned} \quad (\text{A.7})$$

for some constant $C > 0$.

Let us now derive estimates of the space and time differences of the u^h , which implies that the u^h sequences are relatively compact in $L^2(\Omega_T)$.

However, this can be done exactly as in 32 and we obtain the following estimates: there is a positive constant $C > 0$ depending on Ω, T and \mathbf{u}_0 , such that:

$$\iint_{\Omega' \times (0,T)} |\mathbf{u}^h(t, x + \mathbf{r}) - \mathbf{u}^h(t, x)|^2 dx dt \leq C |\mathbf{r}|^2 + T \sup_{0 < |\mathbf{r}| \leq \delta} \int_{\Omega_{\mathbf{r}}} |\mathbf{u}_0^h(\mathbf{x} + \mathbf{r}) - \mathbf{u}_0^h(\mathbf{x})|^2, \quad (\text{A.8})$$

for all $\mathbf{r} \in \mathbb{R}^3$ with $\Omega' = \{x \in \Omega, [x, x + \mathbf{r}] \subset \Omega_H\}$, and:

$$\iint_{\Omega_H \times (0, T - \tau)} |\mathbf{u}^h(t + \tau, x) - \mathbf{u}^h(t, x)|^2 dx dt \leq C(\tau + \Delta t). \quad (\text{A.9})$$

for all $\tau \in (0, T)$.

In the next step, we introduce $\bar{\mathbf{u}}^h$ the piecewise affine in t functions in $W^{1,\infty}([0, T]; V^h)$ interpolating the state $(\mathbf{u}^{h,n})_{n=0..N} \subset V^h$ at the points $(n\Delta t)_{n=0..N}$. From the system (A.2), it is easy to obtain the uniform bound of $\partial_t \bar{\mathbf{u}}^h$ in $L^2(0, T; (H^1(\Omega, \mathbb{R}^5))^*)$. Then, the consequence of (A.7), (A.8), (A.9) and Kolmogorov's compactness criterion (see, e.g., 34, Theorem IV.25): there exists a subsequence of $\mathbf{u}^h = (M_I^h, H_I^h, A^h, M_s^h, H_s^h)$, not relabeled, such that, as $h \rightarrow 0$:

$$\begin{aligned} & (M_I^h, H_I^h, M_s^h, H_s^h) \rightarrow (M_I, H_I, M_s, H_s) \text{ strongly in } L^2(\Omega_T)^4 \text{ and a.e. in } \Omega_T, \\ & (M_I^h, H_I^h, M_s^h, H_s^h) \rightharpoonup (M_I, H_I, M_s, H_s) \text{ weakly in } L^2(0, T; H^1(\Omega, \mathbb{R}^4)), \\ & (\partial_t \bar{M}_I^h, \partial_t \bar{H}_I^h, \partial_t \bar{M}_s^h, \partial_t \bar{H}_s^h) \rightharpoonup (\partial_t M_I, \partial_t H_I, \partial_t M_s, \partial_t H_s) \\ & \text{weakly in } L^2(0, T; (H^1(\Omega, \mathbb{R}^4))^*), \\ & A^h \rightharpoonup A \text{ weakly in } L^2(\Omega_T) \\ & \partial_t A^h \rightharpoonup \partial_t A \text{ weakly in } L^2(\Omega_T). \end{aligned} \quad (\text{A.10})$$

With the above convergences, we are ready to identify the limit $\mathbf{u} = (M_I, H_I, A, M_s, H_s)$ as a (weak) solution of the system (2.1). Finally, let $\phi_1, \phi_2, \phi_4, \phi_5 \in L^2(0, T, H^1(\Omega))$ and $\phi_3 \in C([0, T], L^2(\Omega))$, then by passing to the limit $h \rightarrow 0$ in the following weak formulation:

$$\begin{aligned}
 & \iint_{\Omega_T} \partial_t \bar{M}_I^h \phi_1 dxdt + \epsilon_M \iint_{\Omega_T} \nabla M_I^h \cdot \nabla \phi_1 dxdt \\
 & \quad = \iint_{\Omega_T} \left(f^{M_I}(\mathbf{u}^h) - \alpha \nu^h M_I^h \right) \phi_1 dxdt \\
 & \iint_{\Omega_T} \partial_t \bar{H}_I^h \phi_2 dxdt + D_H \iint_{\Omega_T} \nabla H_I^h \cdot \nabla \phi_2 dxdt = \iint_{\Omega_T} f^{H_I}(\mathbf{u}^h) \phi_2 dxdt \\
 & \iint_{\Omega_T} \partial_t \bar{A}^h \phi_3 dxdt = \iint_{\Omega_T} \left(f^A(\mathbf{u}^h) - \alpha \nu^h A^h \right) \phi_3 dxdt, \\
 & \iint_{\Omega_T} \partial_t \bar{M}_s^h \phi_4 dxdt + \epsilon_M \iint_{\Omega_T} \nabla M_s^h \cdot \nabla \phi_4 dxdt \\
 & \quad = \iint_{\Omega_T} \left(f^{M_s}(\mathbf{u}^h) - \alpha \nu^h M_s^h \right) \phi_4 dxdt, \\
 & \iint_{\Omega_T} \partial_t \bar{H}_s^h \phi_5 dxdt + D_H \iint_{\Omega_T} \nabla H_s^h \cdot \nabla \phi_5 dxdt = \iint_{\Omega_T} f^{H_s}(\mathbf{u}^h) \phi_5 dxdt,
 \end{aligned}$$

thus, we obtain the limit $\mathbf{u} = (M_I, H_I, A, M_s, H_s)$ which is a solution of system (2.1) in the sense of Definition Appendix A.1.

Appendix B. Optimal Results for Infected Mosquito

30 *dos Santos, Bendahmane, Erraji and Karami*

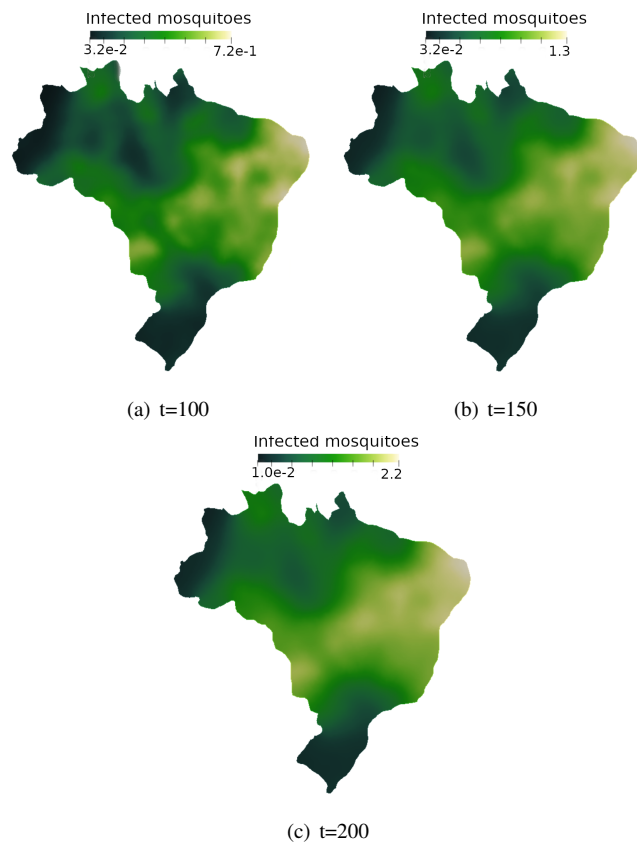

Fig. 9. Spatial distribution of the population density of infected mosquitoes applying optimal control solutions for $\tau_2(t)$, with $\tau_1 = 0.1$.