

**IRSN**

INSTITUT  
DE RADIOPROTECTION  
ET DE SÛRETÉ NUCLÉAIRE

Enhancing nuclear safety

# Development of a multi-zone loading model for scenario studies involving ASTRID-like SFRs

Technical Workshop on Fuel Cycle Simulation

Urbana-Champaign USA

2019 June 26-28

MEMBRE DE

**ETSON**

EUROPEAN  
TECHNICAL SAFETY  
ORGANISATIONS  
NETWORK



**IRSN:**

Léa Tillard (*Ph.D. Student*)

[lea.tillard@irsn.fr](mailto:lea.tillard@irsn.fr)

Dr. Jean-Baptiste Clavel

**IPNO, CNRS:**

Dr. Xavier Doligez

Dr. Marc Ernoult

# Outline

- Context & objectives of the study
- Multi-zone fuel loading model
- One fuel cycle application case
- Conclusion & perspectives

# Context & objectives

## ■ Dynamic fuel cycle simulations with SFR

- Sodium Fast Reactor (SFR) design
  - ASTRID-CFV concept (*Pu breeder, break-even, burner*)
- Simulation with CLASS : integration of new SFR models
  - Dynamic fuel irradiation
    - [https://indico.in2p3.fr/event/16854/attachments/49271/62559/2-Tillard\\_MultizoneFuelIrrModel.pdf](https://indico.in2p3.fr/event/16854/attachments/49271/62559/2-Tillard_MultizoneFuelIrrModel.pdf)
    - L. TILLARD et al., “*Development of a multi-zone irradiation model for scenario studies involving ASTRID-like SFRs*”, ICAPP, France Juan-les-pins 2019
  - Dynamic fuel fabrication
    - Fabrication from a priori unknown spent fuels
    - Conservation of reactor specificities

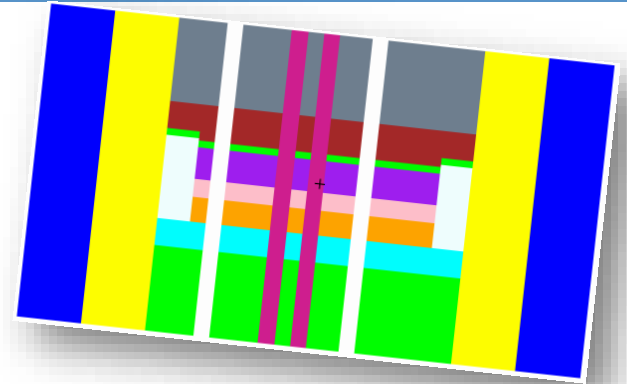

Core Library for  
Advanced Scenario  
Simulation



IRSN

➔ New ASTRID-like fuel loading model in CLASS

# Context & objectives



Axial and radial layouts

## ASTRID-like modeling

- ASTRID: 600 MW<sub>e</sub>, Pu break-even concept (*O.Fabbris, Ph.D. Thesis, CEA, 2014*)
  - Core with low void effect
  - **Heterogeneous**
    - 2 Pu contents (internal & external fissile fuels)
    - Fissile fuel zones 1, 3, 5
    - Fertile fuel zones 2, 4, 6
  - Full core simulation with MCNP6 and VESTA
    - 100% fresh fuel
    - Control assemblies extracted

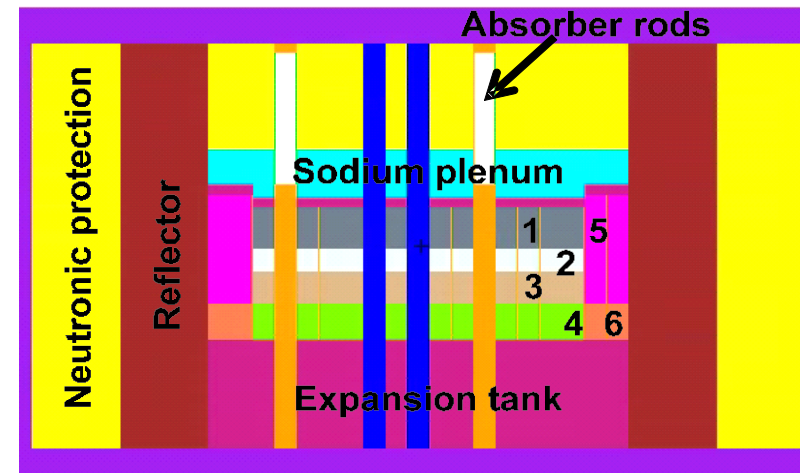
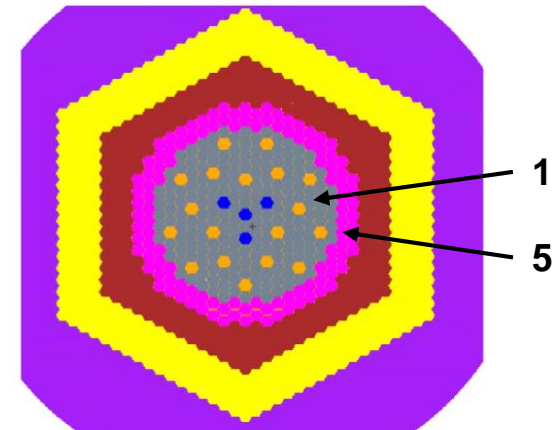

## ➔ ASTRID-like multi-zone reactor

# Multi-zone fuel loading model

## Internal and external Pu contents

- Required 2 criteria to determine the fresh fuel compositions

## Reactor power distribution

- Relation between  $P_{int}$  or  $P_{ext}$  and the Ratio of  $T_{Pu_{int}}$  &  $T_{Pu_{ext}}$ 
  - The model must conserve this relation
  - Set  $P_{int}$  or  $P_{ext}$ , set R

$$P_{int} \text{ and } P_{ext} \propto R = \frac{T_{Pu_{int}}}{T_{Pu_{ext}}}$$

➔ Reactor power distribution:  
Operational criterion for the model

Ratio of internal & external Pu contents, function of the local power

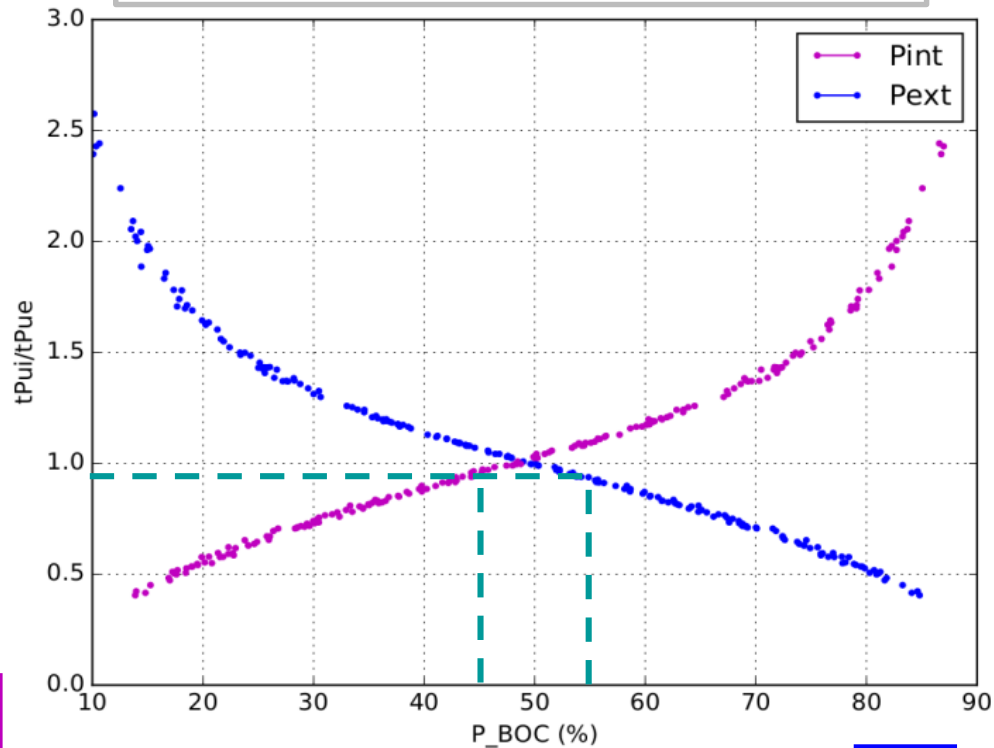

200 different core evolutions

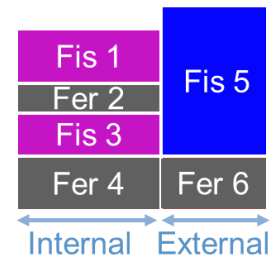

# Multi-zone fuel loading model

## Internal and external Pu contents

- Required 2 criteria to determine the fresh fuel compositions

## Multiplication factor

- Reactor must be critical
  - $k_{\text{eff-BOC}} \sim 1.025$  for the reference fuel (100% fresh fuel)
- $k_{\text{eff}}$  predictor (ANN)
  - Databank of 1000 different fuels for ANN generation
  - Prediction standard deviation  $\sigma \sim 130$  pcm

➔ Multiplication factor:  
Operational criterion for the model

Predictor induced deviations  
on  $k_{\text{eff}}$  at 0 GW.d/t

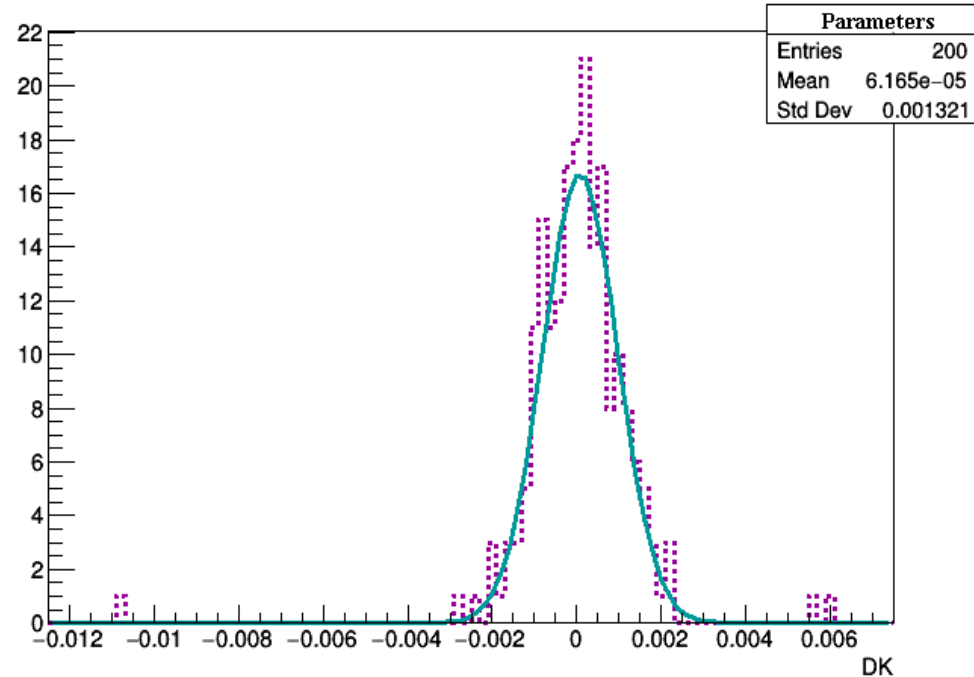

200 different fuels  
independent of the databank

$$D_k = \frac{k_{\text{eff}}^{\text{pred}} - k_{\text{eff}}^{\text{MCNP}}}{k_{\text{eff}}^{\text{MCNP}}}$$

# Multi-zone fuel loading model

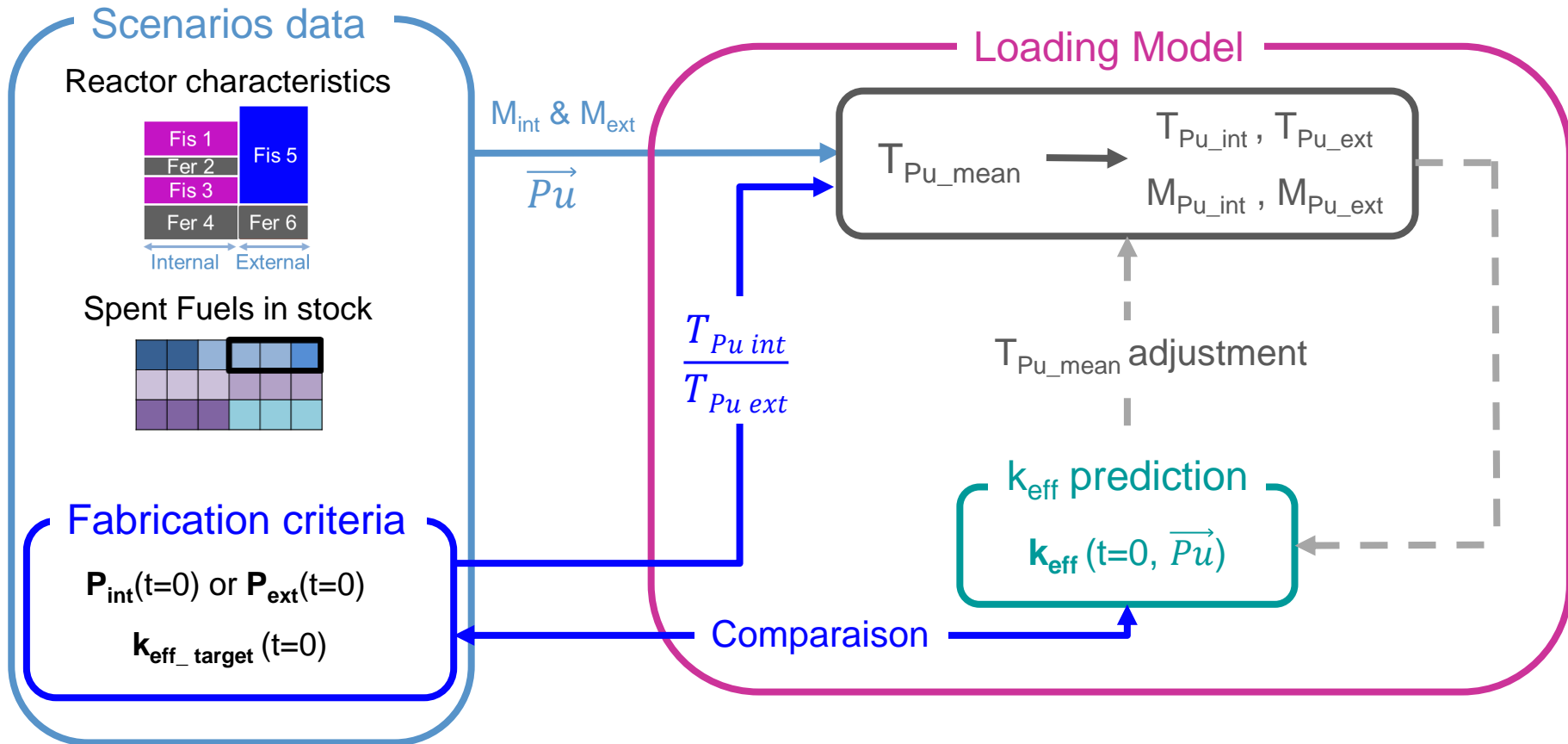

# One fuel cycle application case

## Simple scenario

- Constant total fleet power
- 3 phases :
  - PWR-UOX
  - PWR-UOX + PWR-MOX
  - PWR-UOX + PWR-MOX + SFR-MOX
- Power fraction PWR-MOX / PWR-UOX kept constant during phases 2 and 3
- Sample parameters ~ 1000 simulations
  - PWR-UOX Burn-Up
  - Fleet composition
  - Reprocessing strategies

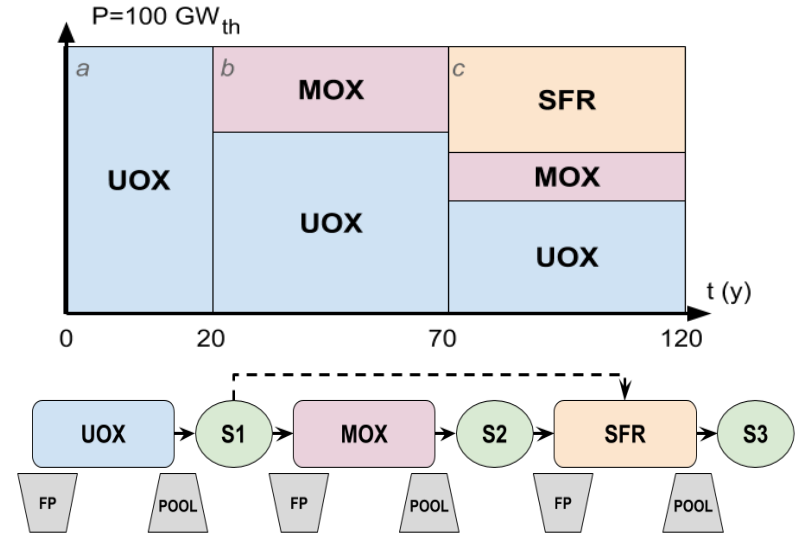

Variables	Case
$BU_{UOX}$ (GWd/t)	[ 30 ; 65 ]
$F_{MOX}^b$ (%)	[ 5 ; 15 ]
$F_{SFR}^c$ (%)	[ 0 ; 30 ]
$SM_{SFR}$	LIFO – FIFO
$S_{SFR}^{in}$	S2 – (S1,S2)



# One fuel cycle application case

## Simple scenario

- For the break-even design the reactor behavior depends on  $\overrightarrow{Pu}$ 
  - $T_{Pu\_mean}$  [19 ; 27] %
  - Pu breeder to burner  
~ [-170 ; +280] kg/GWh<sub>e</sub>
- Pu quality (Q) in spent fuel stocks
  - S1: PWR-UOX [1.6 ; 2.5]
  - S2: PWR-MOX [0.9 ; 1.4]
  - S3: SFR-MOX [1.2 ; 2.1]

$$Q = \frac{N_{239Pu} + N_{241Pu}}{N_{238Pu} + N_{240Pu} + N_{242Pu}}$$

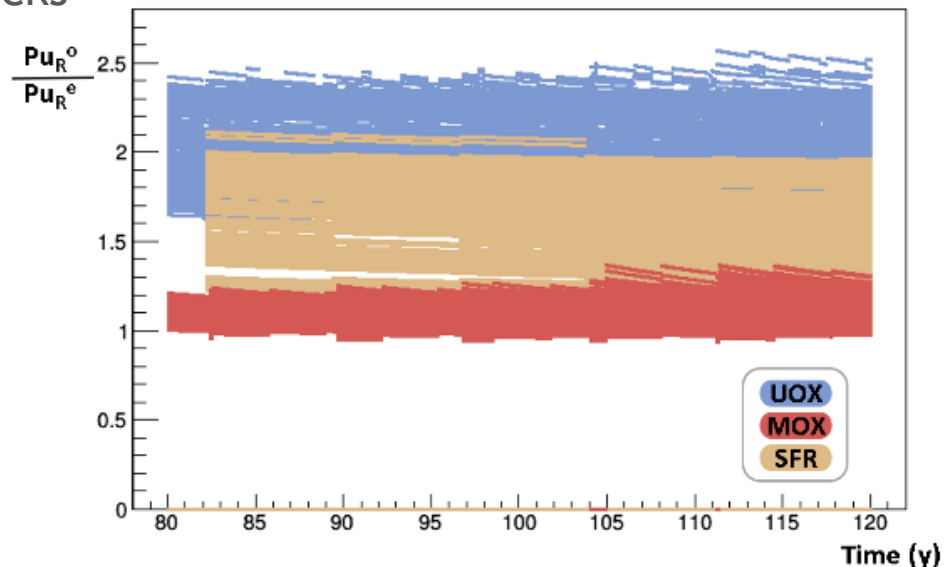
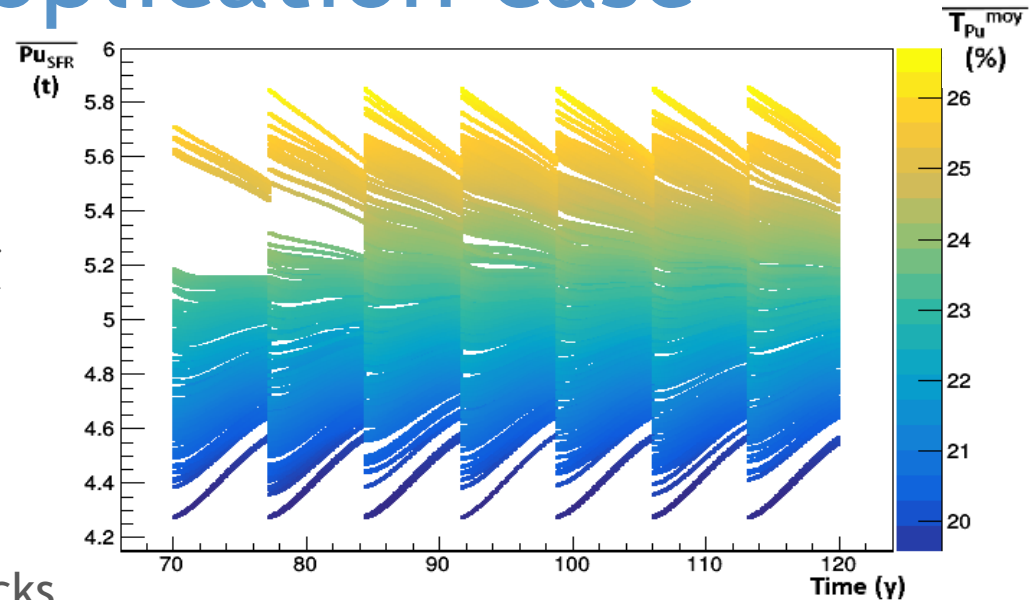

# Conclusion & perspectives

## Simulations of ASTRID-like reactor integration into a PWR fleet

- New multi-zone models for dynamic fuel irradiation & fabrication
- Usable for Pu break-even & burner designs

## Multi-zone fuel loading model

- Reactor heterogeneity & fuel zone interactions maintained
- 2 beginning of cycle criteria
  - $k_{\text{eff}}$  target
  - Power distribution ( $P_{\text{int}}$  or  $P_{\text{ext}}$ )
- Induced deviations on  $k_{\text{eff}}$  predictions by ANN:  $\sigma \sim 130$  pcm



## One fuel cycle application case

- Simple example
  - SFR behavior depends on  $\vec{Pu}$
  - Large variability of Pu quality in SFR spent fuels

## Perspectives

- Scenario studies (GLOBAL 2019 and L. Tillard Ph.D thesis)
- Application of the multi-zone models approach for other reactors

Thank you for your attention !