



HAL
open science

Computational real algebraic geometry and applications to robotics

Guillaume Moroz

► **To cite this version:**

Guillaume Moroz. Computational real algebraic geometry and applications to robotics. Doctoral. Luminy, France. 2021. hal-04117321

HAL Id: hal-04117321

<https://hal.science/hal-04117321>

Submitted on 6 Jun 2023

HAL is a multi-disciplinary open access archive for the deposit and dissemination of scientific research documents, whether they are published or not. The documents may come from teaching and research institutions in France or abroad, or from public or private research centers.

L'archive ouverte pluridisciplinaire **HAL**, est destinée au dépôt et à la diffusion de documents scientifiques de niveau recherche, publiés ou non, émanant des établissements d'enseignement et de recherche français ou étrangers, des laboratoires publics ou privés.

Computational real algebraic geometry and applications to robotics

JNCF lecture, part 1

Guillaume Moroz

Inria Nancy - Grand Est

March 1st, 2021

Mechanisms

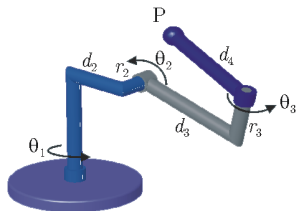
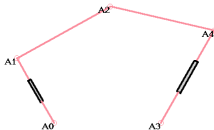
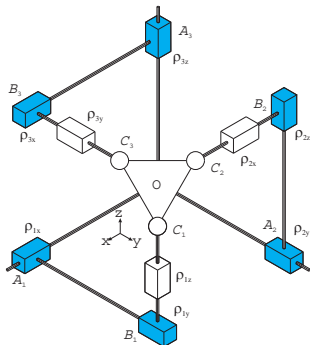
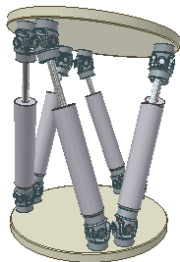

- Joint variables
 - r_1, r_2
- Pose variables
 - x, y
- Passive variables
 - θ_1, θ_2

Parallel PR-PRR

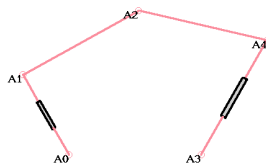

- Equations

$$(F) \begin{cases} x = \cos\left(\frac{2\pi}{3}\right)r_1 + \cos(\theta_1) \\ x = 1 + \cos\left(\frac{\pi}{3}\right)r_2 + \cos(\theta_2) \\ y = \sin\left(\frac{2\pi}{3}\right)r_1 + \sin(\theta_1) \\ y = 1 + \sin\left(\frac{\pi}{3}\right)r_2 + \sin(\theta_2) \end{cases}$$

Workspace, Joint space

- Q : joint space
- W : workspace

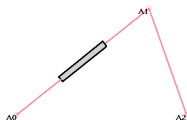

Parallel RPR-R

- Total space: $Q \times W$
 - solutions of F : $V(F) \subset W \times Q$

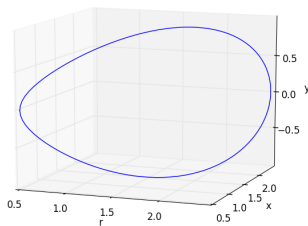

- Canonical projections:
 - $\pi_W : V(F) \rightarrow W$
 - $\pi_Q : V(F) \rightarrow Q$

Serial robot

- Glossary:
 - P: prismatic joint
 - R: rotation joint
 - U: Cardan joint
 - S: spherical joint

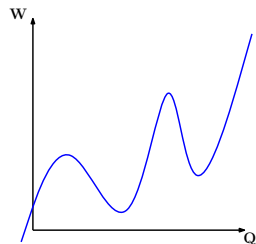
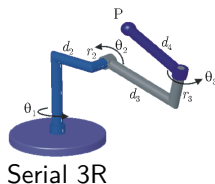

Properties

- Inverse Kinematics (IK) hard
- Forward Kinematics (FK) easy: 1 solutions

Parallel robot

- Glossary:

- P: prismatic joint
- R: rotation joint
- U: Cardan joint
- S: spherical joint

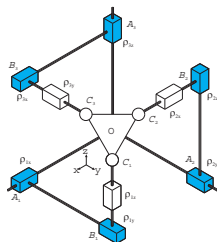

Parallel 3-PPPS

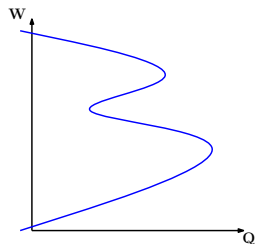

Properties

- Inverse Kinematics (IK) easy
- Forward Kinematics (FK) hard: several solutions
- 2 solutions can cross
 - loose of control
 - break

Covering map

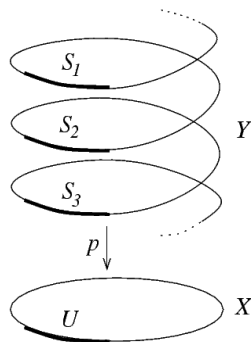

Definition

The continuous map $f : S \rightarrow U$ is a **covering map** if:

$$f^{-1}(U) = S_1 \cup \dots \cup S_k \text{ where } \begin{cases} S_i \simeq U \\ S_i \text{ pairwise disjoint.} \end{cases}$$

Critical points

- $V \subset \mathbb{R}^n$ smooth variety of dimension p
- $\pi : V \rightarrow \mathbb{R}^p$ canonical projection

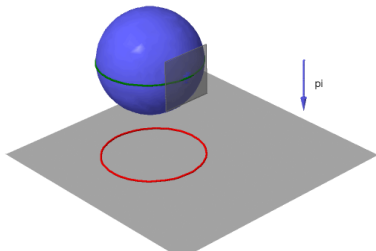

Critical points

Let $T(a)$ be the linear space tangent to V at point a .
The **critical points** a of V for the projection π satisfy:

$$\dim(\pi(T(a))) < p$$

Case of the serial robot

Hypothesis: $V(F)$ smooth, bounded, equidimensional.

- FK: always 1 solution $\Rightarrow \pi_Q : V(F) \rightarrow Q$ invertible
- IK: partition W in W_0, W_1, \dots, W_k s.t.:
 - W_0 are the critical values of π_W
 - W_1, \dots, W_k are the connected components of $W \setminus W_0$
- Critical points of π_W : **serial singularities**

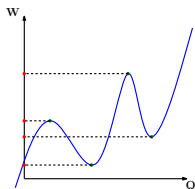

Theorem (covering map and critical values)

For all $1 \leq i \leq k$, the restriction of π_W to $\pi_W^{-1}(W_i)$ is a covering map above W_i .

Case of parallel robot

Hypothesis: $V(F)$ smooth, bounded, equidimensional.

- IK: always 1 solution $\Rightarrow \pi_W : V(F) \rightarrow W$ invertible
- FK: partition Q in Q_0, Q_1, \dots, Q_k s.t.:
 - Q_0 are the critical values of π_Q
 - Q_1, \dots, Q_k are the connected components of $Q \setminus Q_0$
- Critical points of π_Q : **parallel singularities**

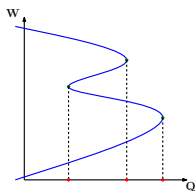

Theorem (covering map and critical values)

For all $1 \leq i \leq k$, the restriction of π_Q to $\pi_Q^{-1}(Q_i)$ is a covering map above Q_i .

Case of parallel robots

- FK: $F_q(x) = 0$, system parametrized by q
- For fixed q , finitely many solutions (0-dimensional)
- π_Q is not a covering map near q
 - \Rightarrow two sheets of solutions cross
 - $\Rightarrow F_q(x) = 0$ has singular solutions

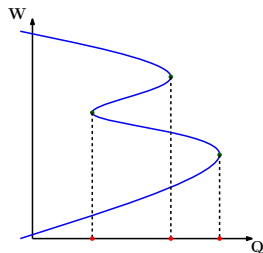

- Remark: $V(F)$
 - not bounded: take asymptotes into account
 - not smooth: take singularities into account

Hypothesis: $V(F)$ smooth, bounded, equidimensional.

$$\underbrace{\frac{\partial F}{\partial q}}_A dq + \underbrace{\frac{\partial F}{\partial x}}_B dx = 0$$

- Serial singularities

$$(S_s) : F = 0, \det(A) = 0$$

- W_0 , critical values of π_W : projection on x_i of solutions of (S_s)
- W_1, \dots, W_k , complement of critical values

Hypothesis: $V(F)$ smooth, bounded, equidimensional.

$$\underbrace{\frac{\partial F}{\partial q}}_A dq + \underbrace{\frac{\partial F}{\partial x}}_B dx = 0$$

- Parallel singularities

$$(S_p) : F = 0, \det(B) = 0$$

- Q_0 , critical values of π_Q : projection on q_i of solutions of (S_p)
- Q_1, \dots, Q_k , complement of critical values

Example

- 3-PPPS:

- Parallel
- Joint variables: $x_1, y_1, y_2, z_2, x_3, z_3$
- Pose variables: $p_x, p_y, p_z, \varphi, \theta, \sigma$

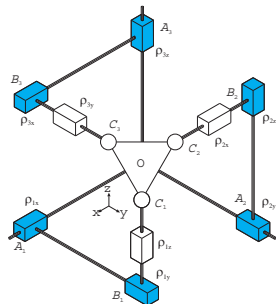

- Critical values of π_Q , and partition of Q

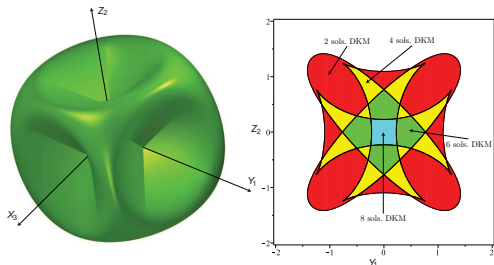

Design challenges

- $E \subset W$ given shape
 - Design a **parallel robot** without singularities in E

$$\pi_W(\text{critical points of } \pi_Q) \cap E = \emptyset$$

- Maximise the volume of E (lecture P. Lairez)
- \rightarrow design variables

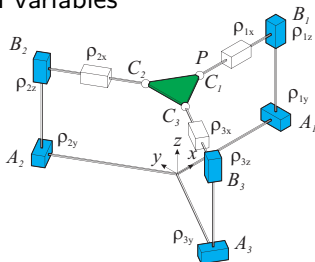
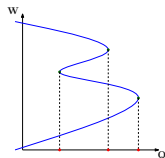

Demo

Modeling equations

- 1 Linkages
- 2 Rotations 3D
- 3 Singularities

Planar Rigid Linkage: Laman Graph

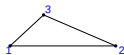

3-bar

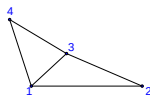

5-bar

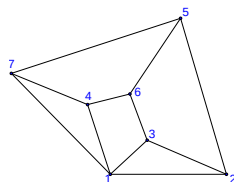

11-bar

Constraints

- Fixed length bars: c_{ij}
- Free revolute joints
- Zero degree of freedom

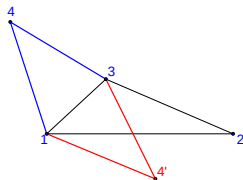

- Several assembly modes
- Number depends on c_{ij}
- Max number of assembly modes?

Properties of Rigid Linkages

- Construction steps



Henneberg steps: H_1 and H_2

- 3-bar rigid linkage

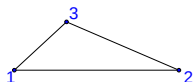

Properties of Rigid Linkages

- Construction steps



Henneberg steps: H_1 and H_2

- 5-bar rigid linkage

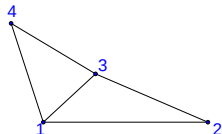

Properties of Rigid Linkages

- Construction steps



Henneberg steps: H_1 and H_2

- 7-bar rigid linkage

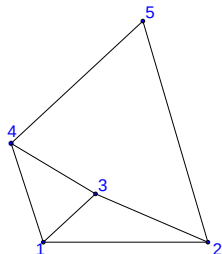

Properties of Rigid Linkages

- Construction steps



Henneberg steps: H_1 and H_2

- 9-bar rigid linkage

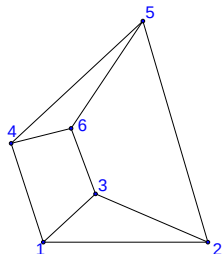

Properties of Rigid Linkages

- Construction steps



Henneberg steps: H_1 and H_2

- 11-bar rigid linkage

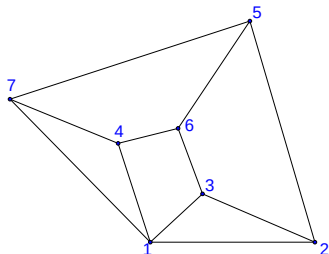

Theorem

A linkage is rigid \Leftrightarrow It can be constructed with H_1 and H_2

Corollary

$$\#Links = 2\#Joints - 3$$

Algebraic Modeling I

- c_{ij} : 10 parameters
- x_i, y_i : 14 variables

$$\begin{cases} x_1 = 0, y_1 = 0 \\ x_2 = 1, y_2 = 0 \end{cases}$$

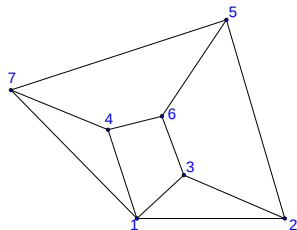

$$\begin{cases} x_3^2 + y_3^2 = c_{13} \\ (x_3 - 1)^2 + y_3^2 = c_{23} \\ (x_5 - 1)^2 + y_5^2 = c_{25} \\ (x_6 - x_3)^2 + (y_6 - y_3)^2 = c_{36} \\ x_4^2 + y_4^2 = c_{14} \end{cases}$$

$$\begin{cases} x_7^2 + y_7^2 = c_{17} \\ (x_6 - x_4)^2 + (y_6 - y_4)^2 = c_{46} \\ (x_5 - x_6)^2 + (y_5 - y_6)^2 = c_{56} \\ (x_7 - x_5)^2 + (y_7 - y_5)^2 = c_{57} \\ (x_4 - x_7)^2 + (y_4 - y_7)^2 = c_{47} \end{cases}$$

Number of solutions

- Mixed Volume: $n! \text{Volume}(\text{Support})$ (same support)

1 variable

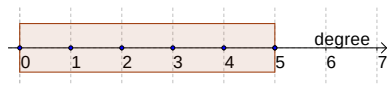

$$1 - X + 3X^2 - X^3 + 6X^4 - 5X^5 = 0$$

2 variables

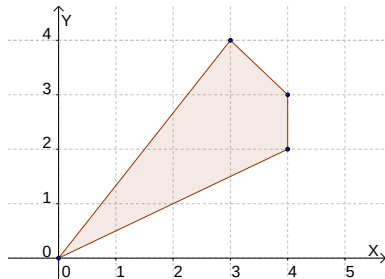

$$\begin{cases} 1 - X^4 Y^2 + 7X^4 Y^3 - 4X^3 Y^4 = 0 \\ 8 + 6X^4 Y^2 - 5X^4 Y^3 - X^3 Y^4 = 0 \end{cases}$$

- Our system: 2^{10}

Algebraic Modeling II

- Cayley-Menger matrix or distance matrix

$$\begin{array}{c} v_1 \\ v_2 \\ v_3 \\ v_4 \\ v_5 \\ v_6 \\ v_7 \end{array} \begin{bmatrix} 0 & 1 & 1 & 1 & 1 & 1 & 1 & 1 \\ 1 & 0 & c_{12} & c_{13} & c_{14} & x_{15} & x_{16} & c_{17} \\ 1 & c_{12} & 0 & c_{23} & x_{24} & c_{25} & x_{26} & x_{27} \\ 1 & c_{13} & c_{23} & 0 & x_{34} & x_{35} & c_{36} & x_{37} \\ 1 & c_{14} & x_{24} & x_{34} & 0 & x_{45} & c_{46} & c_{47} \\ 1 & x_{15} & c_{25} & x_{35} & x_{45} & 0 & c_{56} & c_{57} \\ 1 & x_{16} & x_{26} & c_{36} & c_{46} & c_{56} & 0 & x_{67} \\ 1 & c_{17} & x_{27} & x_{37} & c_{47} & c_{57} & x_{67} & 0 \end{bmatrix}$$

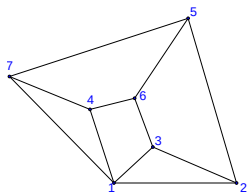

Theorem

The distance matrix has rank 4.

Corollary

All the 5x5 minors vanish.

Algebraic Modeling II

$$\left\{ \begin{array}{l} D(0, 4, 5, 6, 7)(c_{46}, c_{47}, c_{56}, c_{57}, x_{45}, x_{67}) = 0 \\ D(0, 1, 4, 6, 7)(c_{14}, c_{17}, c_{46}, c_{47}, x_{16}, x_{67}) = 0 \\ D(0, 1, 4, 5, 7)(c_{14}, c_{17}, c_{47}, c_{57}, x_{15}, x_{45}) = 0 \\ D(0, 1, 2, 3, 5)(c_{12}, c_{13}, c_{25}, c_{23}, x_{15}, x_{35}) = 0 \\ D(0, 1, 3, 5, 6)(c_{13}, c_{36}, c_{56}, x_{15}, x_{16}, x_{35}) = 0 \end{array} \right.$$

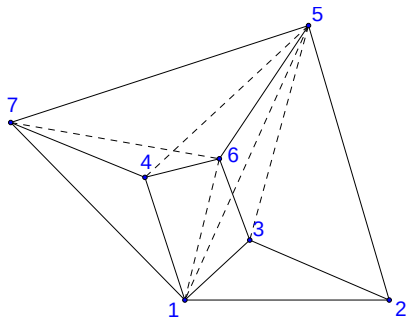

- Upper bound
 - Mixed volume: 56
- Lower Bound?

Sampling

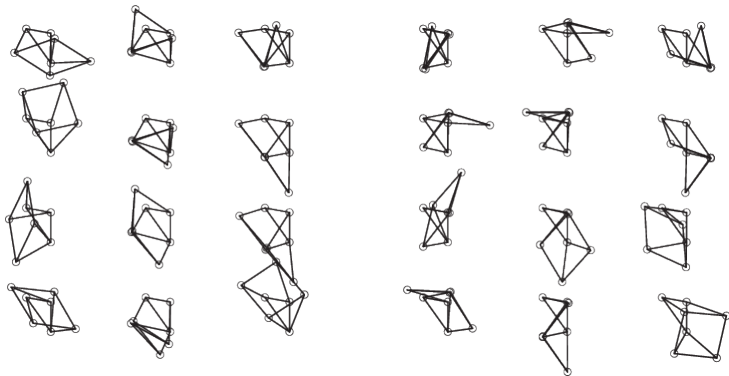

Number of assembly modes

| | Maximal number of assembly modes | | | | | | | |
|-------|----------------------------------|---|---|----|----|-----|-----|-----|
| bars | 3 | 5 | 7 | 9 | 11 | 13 | 15 | 17 |
| upper | 2 | 4 | 8 | 24 | 56 | 136 | 344 | 880 |
| lower | 2 | 4 | 8 | 24 | 56 | 136 | 344 | 860 |

- [Bartzosa, Emiris, Legerský, Tsigaridas 2021]
- Started in 2002 with Borcea
- Bartzosa, Borcea, Emiris, Legerský, M., Streinu, Capco, Gallet, Grasegger, Koutschan, Lubbes, Schicho, Tsigaridas, ...

Rotations matrix in 3D

$$R = \begin{pmatrix} x_1 & x_2 & x_3 \\ y_1 & y_2 & y_3 \\ z_1 & z_2 & z_3 \end{pmatrix}$$

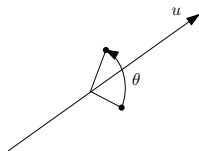

$$R^T R = I$$

- Action of R is a rotation by θ around an axe u
- Set of rotation has dim 3

$$R_x(\theta) = \begin{pmatrix} 1 & 0 & 0 \\ 0 & \cos(\theta) & \sin(\theta) \\ 0 & -\sin(\theta) & \cos(\theta) \end{pmatrix}$$

$$R_y(\varphi) = \begin{pmatrix} \cos(\varphi) & 0 & \sin(\varphi) \\ 0 & 1 & 0 \\ -\sin(\varphi) & 0 & \cos(\varphi) \end{pmatrix}$$

$$R_z(\psi) = \begin{pmatrix} \cos(\psi) & \sin(\psi) & 0 \\ -\sin(\psi) & \cos(\psi) & 0 \\ 0 & 0 & 1 \end{pmatrix}$$

$$R = R_z(\psi)R_y(\varphi)R_x(\theta) \quad \text{or} \quad R = R_z(\psi)R_y(\varphi)R_z(\theta)$$

$$q_i^2 + q_j^2 + q_k^2 + q_r^2 = 1$$

$$R = \begin{pmatrix} 1 - 2(q_j^2 + q_k^2) & 2(q_i q_j - q_k q_r) & 2(q_i q_k + q_j q_r) \\ 2(q_i q_j + q_k q_r) & 1 - 2(q_i^2 + q_k^2) & 2(q_j q_k - q_i q_r) \\ 2(q_i q_k - q_j q_r) & 2(q_j q_k + q_i q_r) & 1 - 2(q_i^2 + q_j^2) \end{pmatrix}$$

Rotation of **axe:** (q_i, q_j, q_k)
angle: $2 \arccos(q_r)$

Anti-symmetric matrix - Exponential map

In 2D

$$\theta \Rightarrow \begin{pmatrix} \cos(\theta) & -\sin(\theta) \\ \sin(\theta) & \cos(\theta) \end{pmatrix}$$

In 3D

$$A = \begin{pmatrix} 0 & z & -y \\ -z & 0 & x \\ y & -x & 0 \end{pmatrix}$$

$$R = e^A$$

Rotation of **axe:** (x, y, z)
angle: $\|(x, y, z)\|_2$

Anti-symmetric matrix - Cayley transform

In 2D

$$t = \tan\left(\frac{\theta}{2}\right) \Rightarrow \begin{pmatrix} \frac{1-t^2}{1+t^2} & \frac{-2t}{1+t^2} \\ \frac{2t}{1+t^2} & \frac{1-t^2}{1+t^2} \end{pmatrix}$$

In 3D

$$A = \begin{pmatrix} 0 & z & -y \\ -z & 0 & x \\ y & -x & 0 \end{pmatrix}$$

$$R = (I - A)(I + A)^{-1}$$

Rotation of **axe:** (x, y, z)
angle: $2 \arctan(\|(x, y, z)\|_2)$

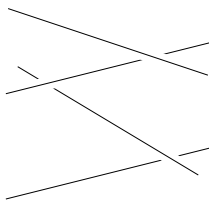

How many lines intersect 4 given lines?

$$P_1 = \begin{pmatrix} x_1 \\ y_1 \\ z_1 \end{pmatrix} \quad P_2 = \begin{pmatrix} x_2 \\ y_2 \\ z_2 \end{pmatrix} \quad M = \begin{pmatrix} x_1 & x_2 \\ y_1 & y_2 \\ z_1 & z_2 \\ 1 & 1 \end{pmatrix}$$

Definition

The Plücker coordinates of the line (P_1P_2) are the 6 minors of M

$$(d_x, d_y, d_z, m_x, m_y, m_z) = (P_2 - P_1, OP_1 \times OP_2)$$

- $(d, m) \in \mathbf{P}_5$ is on the Klein quadric

$$d \cdot m = 0$$

- Lines (d, m) and (d', m') intersect implies

$$d \cdot m' + m \cdot d' = 0$$

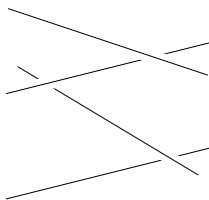

0, 1, 2 or infinitely many lines cross the 4 given lines

$$f_1(\mathbf{q}, \mathbf{x}), \dots, f_m(\mathbf{q}, \mathbf{x})$$

$$B = \begin{matrix} f_1 \\ \vdots \\ f_m \end{matrix} \begin{pmatrix} \frac{\partial}{\partial x_1} \cdots \frac{\partial}{\partial x_m} \\ \frac{\partial f_j}{\partial x_j} \end{pmatrix}$$

- $\det(B)$ multi-linear in its columns/rows
- $\det(B)$ of deg 1 in x_j leads to a parametrization of the singularities
- Simplifies the analysis of the singularities, as in the 3-RPR [Coste 2012]

Plan parallel robot 3-RPR

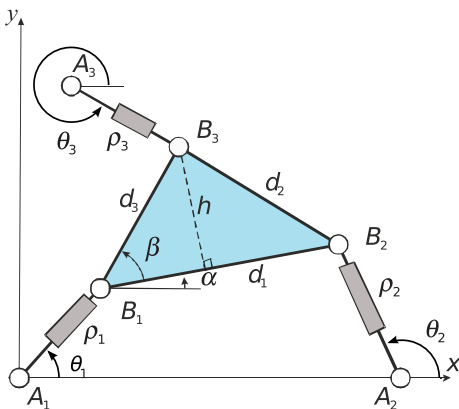

- 3 degrees of freedom
- $d_1, d_2, d_3, A_1, A_2, A_3$ fixed
- Joint variables: r_1, r_2, r_3
- Pose variables: α, B_{1x}, B_{1y}

Demo

Singularity of parallel manipulator with Plücker vectors

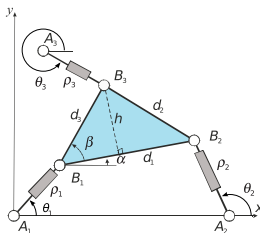
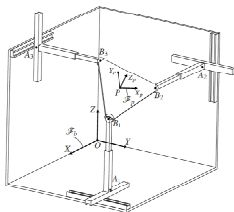

Remark

If the leg-platform joints are spherical, the rows of the inverse kinematic Jacobian matrix $A^{-1}B$ will involve the Plücker coordinates of lines associated to the legs.

⇒ singularities can be interpreted geometrically

Cuspidal configuration

- **Cuspidal point:** point of order ≥ 3
- **Characterization:** A cuspidal robot has at least one cuspidal point

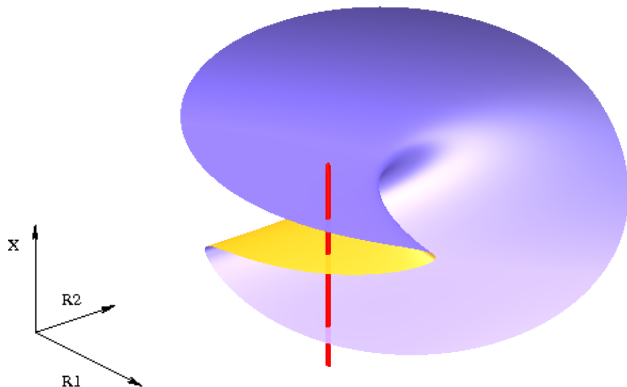

Demo

Further reading

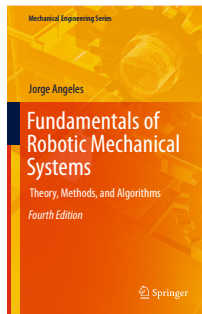
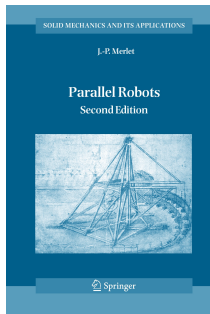

À suivre

Solving systems

- 1 With initial point
 - Newton
- 2 Without initial point
 - Symbolic approaches
 - Numerical approaches

Computational real algebraic geometry and applications to robotics

JNCF lecture, part 2

Guillaume Moroz

Inria Nancy - Grand Est

March 4th, 2021

Solving systems

- ① With initial point
 - Newton
- ② Without initial point
 - Symbolic approaches
 - Numerical approaches

$$f(x) = 0$$

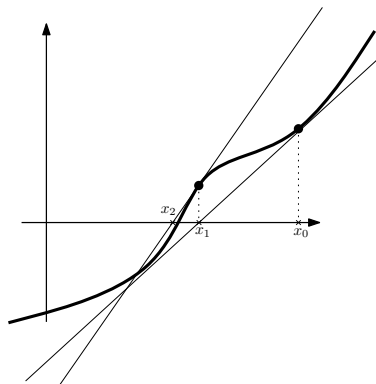

x_0 = initial point

$$x_{n+1} = x_n - \frac{f(x_n)}{f'(x_n)}$$

Good for path tracking

$$f(x) = 0$$

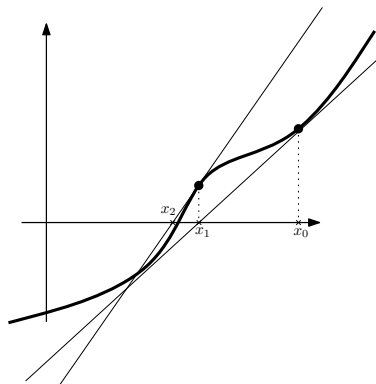

x_0 = initial point

$$x_{n+1} = x_n - Df(x_n)^{-1}f(x_n)$$

Good for path tracking

$$K(f, x_0) = \sup_x \|Df(x_0)^{-1}D^2f(x)\|$$
$$\beta(f, x_0) = \|Df(x_0)^{-1}f(x_0)\|$$

Theorem (Kantorovich)

If $\beta(f, x_0)K(f, x_0) \leq 1/2$,
then f has a unique solution in $B(x_0, 2\beta(f, x_0))$.

$$\gamma(f, x_0) = \sup_{k \geq 2} \left\| Df(x_0)^{-1} \frac{D^k f(x_0)}{k!} \right\|^{\frac{1}{k-1}}$$
$$\beta(f, x_0) = \left\| Df(x_0)^{-1} f(x_0) \right\|$$

Theorem (Smale)

If $\beta(f, x_0)\gamma(f, x_0) \leq 3 - 2\sqrt{2}$,
then f has a unique solution in $B(x_0, \frac{1-\sqrt{2}/2}{\gamma(f, x_0)})$.

Reliable interval Newton

B a box interval containing p

1 variable

$$N(x) = p - \left(\frac{f(x) - f(p)}{x - p} \right)^{-1} f(p)$$

$N(B) \subset B \Rightarrow N$ has a fix point in B
 $\Rightarrow f$ has a solution in B

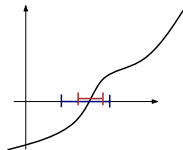

2 variables or more

$$N(B) = p - \square J(B)^{-1} \begin{pmatrix} f(p) \\ g(p) \end{pmatrix}$$

$N(B) \subset B \Rightarrow f = g = 0$ has a solution in B

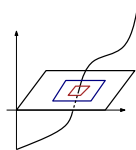

Interval operations

$$[a, b] \oplus [c, d] = [a + c, b + d]$$

$$[a, b] \otimes [c, d] = [\min(ac, ad, bc, bd), \max(ac, ad, bc, bd)]$$

Further reading

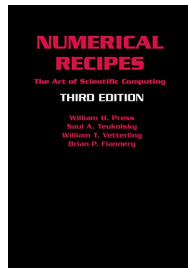
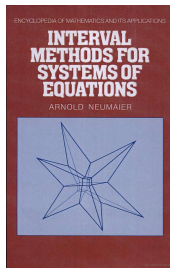
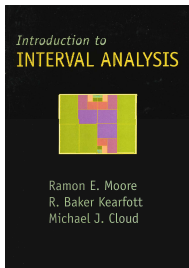
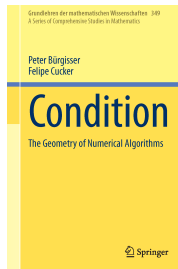
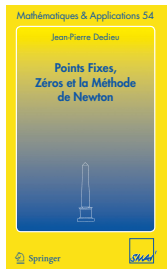
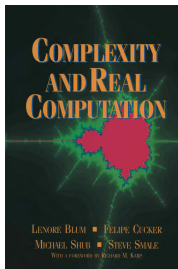

Computer Algebra Systems

- Maple
- Mathematica
- Mathmagix (mmx)
- Matlab
- SageMath
- Xcas
- ...

Numerical Newton

- Boost (C++)
- MPSolve (C) [Bini, Fiorentino, Robol]
- GNU Scientific Library (C)
- Roots, Optim, NLSolve (Julia)
- Scipy (Python)
- ...

Interval and ball arithmetic Libraries

- Arb (C, Python) [Johansson]
- GAOL (C++) [Goualard]
- Intlab (Octave/Matlab) [Rump]
- mpfi (C) [Revol]
- numerix (mmx, C++) [van der Hoeven]
- IntervalArithmetic (Julia) [Benet, Sanders]
- ...

Univariate Representation

Reduce problem to univariate polynomial

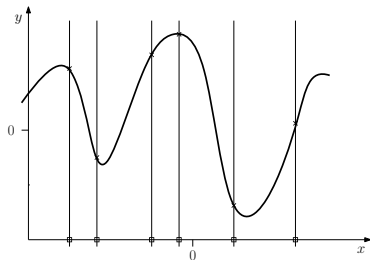

$$p(x) = 0$$
$$y = q(x)$$

Resultant definition

Given two polynomials in $\mathbb{C}[y]$:

- $P = p_0 y^d + \dots + p_d$ with roots $\sigma_1, \dots, \sigma_d$
- $Q = q_0 y^d + \dots + q_d$ with roots τ_1, \dots, τ_d

Definition: Resultant

$$\begin{aligned} \text{Res}(P, Q) &= p_0^d q_0^d \prod_{i,j} (\sigma_i - \tau_j) \\ &= p_0^d \boxed{Q}(\sigma_1) \cdots \boxed{Q}(\sigma_d) \\ &= (-1)^{d^2} q_0^d \boxed{P}(\tau_1) \cdots \boxed{P}(\tau_d) \end{aligned}$$

Resultant definition

Bezout

$$\varphi: \mathbb{C}[y]_{d-1} \times \mathbb{C}[y]_{d-1} \rightarrow \mathbb{C}[y]_{2d-1}$$
$$U, V \mapsto UP + VQ$$

$$\varphi(U, V) = 1 \Leftrightarrow \gcd(P, Q) = 1$$
$$\Leftrightarrow \varphi \text{ invertible}$$

- **Resultant** r is the determinant of the **Sylvester Matrix**
- $r \in \langle P, Q \rangle = I$

Definition: Sylvester matrix

$$\begin{pmatrix} 1 & 2 & \dots & & d+1 & d+2 & d+3 & \dots \\ p_0 & & & & q_0 & & & \\ p_1 & p_0 & & & q_1 & q_0 & & \\ p_2 & p_1 & p_0 & & q_2 & q_1 & q_0 & \\ p_3 & p_2 & p_1 & p_0 & q_3 & q_2 & q_1 & q_0 \\ \vdots & \vdots & \vdots & \vdots & \ddots & \vdots & \vdots & \vdots & \ddots \end{pmatrix}$$

Bivariate case

Given two polynomials in $\mathbb{C}[x, y]$ of degree d in x and y :

- $P = p_0(x)y^d + \dots + p_d(x)$

- $Q = q_0(x)y^d + \dots + q_d(x)$

- $\text{Res}(P, Q)$ is a polynomial in x

- $O(n^{3-1/\omega+\varepsilon})$ arithmetic operations

[Villard 2018]

- $O(n^{2+\varepsilon})$ randomized in a finite field
[van der Hoeven, Lecerf 2019]

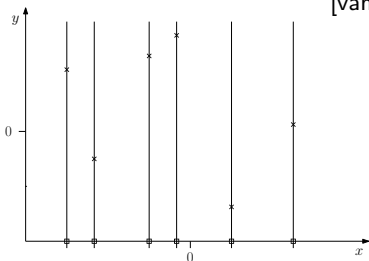

$$\text{Res}_d(P(x, y), Q(x, y))(\alpha) = \text{Res}_d(P(\alpha, y), Q(\alpha, y))$$

First subresultant definition

Given two polynomials in $\mathbb{C}[y]$:

- $P = p_0 y^d + \dots + p_d$ with roots $\sigma_1, \dots, \sigma_d$
- $Q = q_0 y^d + \dots + q_d$ with roots τ_1, \dots, τ_d

Properties

- $Sres_1 = s_1 y + s_0$ has degree at most 1
- $Sres_1 \in \langle P, Q \rangle = I$

Definition: first subresultant

$$Sres_1(P, Q) = p_0^{d-1} \left((y - \sigma_1) \prod_{j \neq 1} \frac{Q(\sigma_j)}{\sigma_j - \sigma_1} + \dots + (y - \sigma_d) \prod_{j \neq d} \frac{Q(\sigma_j)}{\sigma_j - \sigma_d} \right)$$

First subresultant definition

$$\varphi : \mathbb{C}[y]_{d-2} \times \mathbb{C}[y]_{d-2} \rightarrow \mathbb{C}[y]_{2d-2}$$
$$U \quad , \quad V \quad \mapsto UP + VQ$$

The s_0 and s_1 are the determinants of minors of the Sylvester Matrix

Sylvester matrix

$$\begin{pmatrix} 1 & 2 & \dots & & d+1 & d+2 & d+3 & \dots \\ p_0 & & & & q_0 & & & \\ p_1 & p_0 & & & q_1 & q_0 & & \\ p_2 & p_1 & p_0 & & q_2 & q_1 & q_0 & \\ p_3 & p_2 & p_1 & p_0 & q_3 & q_2 & q_1 & q_0 \\ \vdots & \vdots & \vdots & \vdots & \ddots & \vdots & \vdots & \vdots & \ddots \end{pmatrix}$$

Parametrization of y

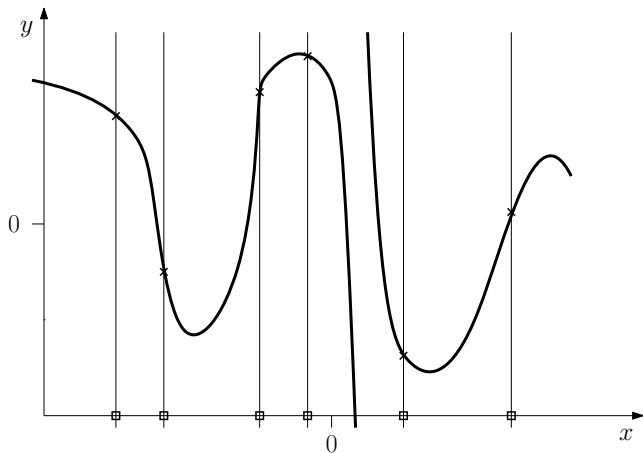

$$s_1(x)y + s_0(x) = 0$$

$$r(x) = 0$$

Three variables and more

$$f_1(x_1, \dots, x_n) = \dots = f_n(x_1, \dots, x_n) = 0$$

Problem

$$\text{Find } p(x_1) = q_1 f_1 + \dots + q_n f_n$$

Matrix of $1, x_1, \dots, x_1^D$ modulo $\langle f_1, \dots, f_n \rangle$

$$M = \begin{matrix} m_1 \\ \vdots \\ m_k \end{matrix} \begin{pmatrix} 1 & \dots & x_1^D \\ \vdots & \ddots & \vdots \\ \vdots & \ddots & \vdots \end{pmatrix}$$

$$\Rightarrow v \in \text{Ker}(M) \text{ iff } v_0 + \dots + v_D x^D \in \langle f_1, \dots, f_n \rangle$$

Three variables and more

$$f_1(x_1, \dots, x_n) = \dots = f_n(x_1, \dots, x_n) = 0$$

Problem

$$\text{Find } p(x_1) = q_1 f_1 + \dots + q_n f_n$$

Matrix of multiplication by x_1 modulo $\langle f_1, \dots, f_n \rangle$

$$M = \begin{matrix} & x_1 m_1 & \dots & x_1 m_k \\ \begin{matrix} m_1 \\ \vdots \\ m_k \end{matrix} & \left(\begin{array}{ccc} & & \\ & & \\ & & \end{array} \right) \end{matrix}$$

$$\Rightarrow \chi_M(x_1) \in \langle f_1, \dots, f_n \rangle$$

Three variables and more

$$f_1(x_1, \dots, x_n) = \dots = f_n(x_1, \dots, x_n) = 0$$

Problem

$$\text{Find } p(x_1) = q_1 f_1 + \dots + q_n f_n$$

Matrix of multiplication by x_1 modulo $f_1(x_1)$

$$M = \begin{pmatrix} 0 & 0 & \dots & 0 & -c_0 \\ 1 & 0 & \dots & 0 & -c_1 \\ 0 & 1 & \dots & 0 & -c_2 \\ \vdots & \vdots & \ddots & \vdots & \vdots \\ 0 & 0 & \dots & 1 & -c_{d-1} \end{pmatrix}$$

$$\Rightarrow \chi_M(x_1) = f_1(x_1) \in \langle f_1 \rangle$$

Normal form and univariate representation

Normal form

$$x_1 m_i \pmod{\langle f_1, \dots, f_n \rangle}$$

- Euclidean division by Gröbner basis

Groebner Bases computation

- $n > 2$ in $\tilde{O}((nd)^{(\omega+1)n})$ operations [Bardet, Faugère, Salvy 2015]
- $n = 2$ in $\tilde{O}(d^2)$ with terse representation [van der Hoeven, Larrieu 2018]

Univariate Representation

- Multivariate subresultant
- Rational Univariate Representation [Kronecker 1882, Rouillier 1999]
 - u-resultant and its derivatives at point (t, a_1, \dots, a_n)

$$\text{u-resultant} = C \prod_{\zeta | F(\zeta)=0} (u_0 + u_1 \zeta_n + \dots + u_n \zeta_n)$$

- Lexicographical Gröbner bases
 - Polynomial parametrization generically, bigger size [Dahan, Schost 2004]

Univariate Representation with Geometric Resolution

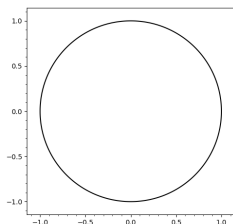

$$f(x, y) = 0$$

Theorem (Hensel lifting)

$$\begin{cases} y_0 & = \text{root of } f(0, y) = 0 \\ y_{n+1}(x) & = y_n(x) - \frac{f(x, y_n(x))}{\frac{\partial f}{\partial y}(x, y_n(x))} \pmod{x^{2^{n+1}}} \end{cases}$$

Then $y_n(x)$ is a root of $f(x, y) = 0 \pmod{x^{2^n}}$.

Univariate Representation with Geometric Resolution

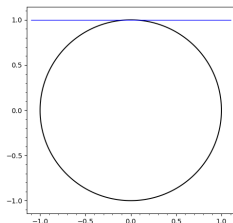

$$f(x, y) = 0$$

Theorem (Hensel lifting)

$$\begin{cases} y_0 & = \text{root of } f(0, y) = 0 \\ y_{n+1}(x) & = y_n(x) - \frac{f(x, y_n(x))}{\frac{\partial f}{\partial y}(x, y_n(x))} \pmod{x^{2^{n+1}}} \end{cases}$$

Then $y_n(x)$ is a root of $f(x, y) = 0 \pmod{x^{2^n}}$.

Univariate Representation with Geometric Resolution

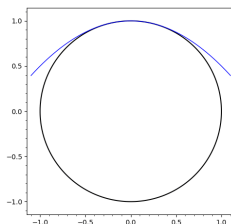

$$f(x, y) = 0$$

Theorem (Hensel lifting)

$$\begin{cases} y_0 & = \text{root of } f(0, y) = 0 \\ y_{n+1}(x) & = y_n(x) - \frac{f(x, y_n(x))}{\frac{\partial f}{\partial y}(x, y_n(x))} \pmod{x^{2^{n+1}}} \end{cases}$$

Then $y_n(x)$ is a root of $f(x, y) = 0 \pmod{x^{2^n}}$.

Univariate Representation with Geometric Resolution

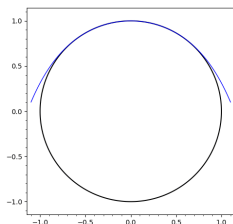

$$f(x, y) = 0$$

Theorem (Hensel lifting)

$$\begin{cases} y_0 & = \text{root of } f(0, y) = 0 \\ y_{n+1}(x) & = y_n(x) - \frac{f(x, y_n(x))}{\frac{\partial f}{\partial y}(x, y_n(x))} \pmod{x^{2^{n+1}}} \end{cases}$$

Then $y_n(x)$ is a root of $f(x, y) = 0 \pmod{x^{2^n}}$.

Univariate Representation with Geometric Resolution

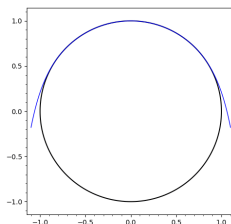

$$f(x, y) = 0$$

Theorem (Hensel lifting)

$$\begin{cases} y_0 & = \text{root of } f(0, y) = 0 \\ y_{n+1}(x) & = y_n(x) - \frac{f(x, y_n(x))}{\frac{\partial f}{\partial y}(x, y_n(x))} \pmod{x^{2^{n+1}}} \end{cases}$$

Then $y_n(x)$ is a root of $f(x, y) = 0 \pmod{x^{2^n}}$.

Univariate Representation with Geometric Resolution

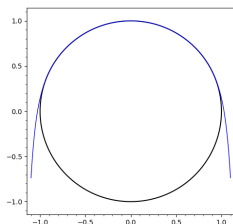

$$f(x, y) = 0$$

Theorem (Hensel lifting)

$$\begin{cases} y_0 & = \text{root of } f(0, y) = 0 \\ y_{n+1}(x) & = y_n(x) - \frac{f(x, y_n(x))}{\frac{\partial f}{\partial y}(x, y_n(x))} \pmod{x^{2^{n+1}}} \end{cases}$$

Then $y_n(x)$ is a root of $f(x, y) = 0 \pmod{x^{2^n}}$.

Univariate Representation with Geometric Resolution

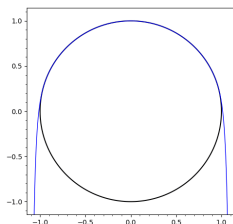

$$f(x, y) = 0$$

Theorem (Hensel lifting)

$$\begin{cases} y_0 & = \text{root of } f(0, y) = 0 \\ y_{n+1}(x) & = y_n(x) - \frac{f(x, y_n(x))}{\frac{\partial f}{\partial y}(x, y_n(x))} \pmod{x^{2^{n+1}}} \end{cases}$$

Then $y_n(x)$ is a root of $f(x, y) = 0 \pmod{x^{2^n}}$.

Univariate Representation with Geometric Resolution

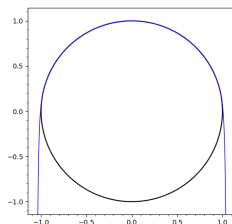

$$f(x, y) = 0$$

Theorem (Hensel lifting)

$$\begin{cases} y_0 & = \text{root of } f(0, y) = 0 \\ y_{n+1}(x) & = y_n(x) - \frac{f(x, y_n(x))}{\frac{\partial f}{\partial y}(x, y_n(x))} \pmod{x^{2^{n+1}}} \end{cases}$$

Then $y_n(x)$ is a root of $f(x, y) = 0 \pmod{x^{2^n}}$.

Univariate Representation with Geometric Resolution

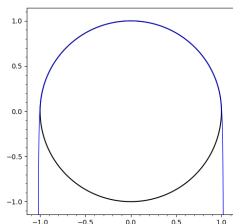

$$f(x, y) = 0$$

Theorem (Hensel lifting)

$$\begin{cases} y_0 & = \text{root of } f(0, y) = 0 \\ y_{n+1}(x) & = y_n(x) - \frac{f(x, y_n(x))}{\frac{\partial f}{\partial y}(x, y_n(x))} \pmod{x^{2^{n+1}}} \end{cases}$$

Then $y_n(x)$ is a root of $f(x, y) = 0 \pmod{x^{2^n}}$.

Univariate Representation with Geometric Resolution

$$f_1(x_1, x_2, x_3) = \dots = f_3(x_1, x_2, x_3) = 0$$

- RUR of $f_1(x_1, x_2, 0)$ and $f_2(x_1, x_2, 0)$

$$p_1(x_1) = 0 \quad x_2 = q_{12}(x_1)$$

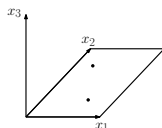

- Lift x_3 in $f_1(x_1, x_2, x_3) = f_2(x_1, x_2, x_3) = 0$

$$\tilde{p}_1(x_1, x_3) = 0 \quad x_2 = \tilde{q}_{12}(x_1, x_3)$$

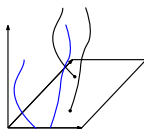

- RUR of $\tilde{p}_{11}(x_1, x_3)$ and $f_3(x_1, \tilde{q}_{12}(x_1, x_3), x_3)$

$$p_2(x_1) = 0 \quad x_2 = q_{22}(x_1) \quad x_3 = q_{23}(x_1)$$

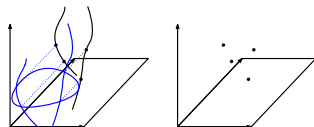

$\tilde{O}(d^{3n})$ operations [Giusti, Lecerf, Salvy 2001]

Further reading

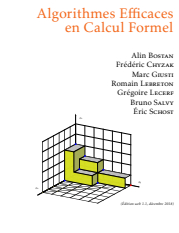
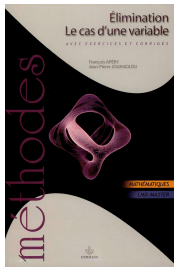
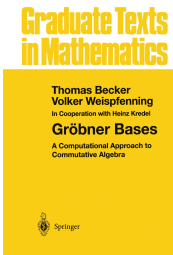
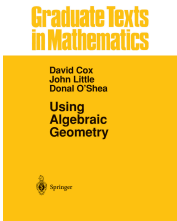
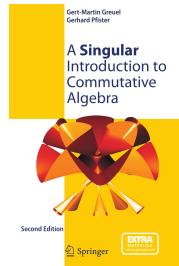
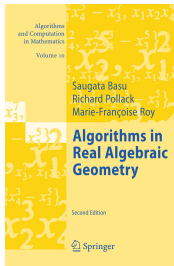
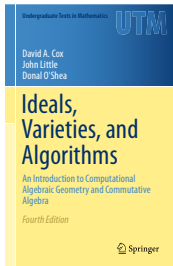
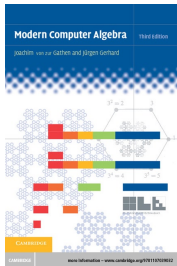

Computer Algebra systems

- Giac/xcas
- Maple
- Magma
- Mathmagix
- Mathematica
- Mcaulay2
- MuPAD
- SageMath
- Singular
- ...

Special purpose libraries/software

- FGb (C) [Faugère]
- Flint (C) [Hart]
- msolve [Berthomieux, Eder, Safey El Din]
- RS/RS3 (C) [Rouillier]
- borderbasis (mmx, C++) [Trebuchet, Mourrain]
- algebramix (mmx, C++) [van der Hoeven, Lecerf]
- geomsolvex (mmx, C++) [Lecerf]
- larrix (mmx, C++) [Larrieu]
- ...

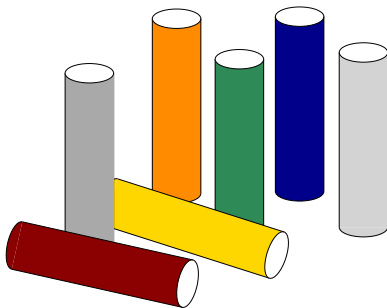

Is it possible to arrange 7 infinite cylinders of unit radius such that they are mutually touching?

Path continuation

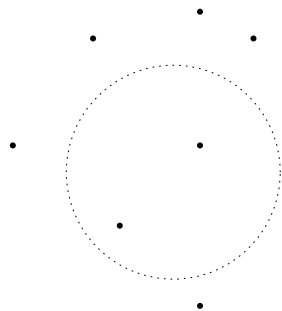

- $f(x) = 0$
- $\deg d$

- We know the solutions of $x^d - 1 = 0$

$$(1 - t)(x^d - 1) + tf(x) = 0$$

- Multivariate case: compute the mixed volume first
- Find 1 solution by following only one path
Polynomial time in $\binom{n+d}{d}$ average [Beltran, Pardo 2009], [Lairez 2017]
- Roots distribution of random polynomials [Edelman, Kostlan 1995]

Path continuation

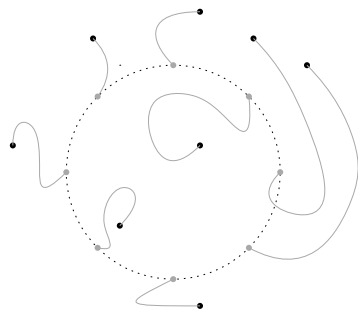

- $f(x) = 0$
- $\deg d$

- We know the solutions of $x^d - 1 = 0$

$$(1 - t)(x^d - 1) + tf(x) = 0$$

- Multivariate case: compute the mixed volume first
- Find 1 solution by following only one path
Polynomial time in $\binom{n+d}{d}$ average [Beltran, Pardo 2009], [Lairez 2017]
- Roots distribution of random polynomials [Edelman, Kostlan 1995]

2 arrangements of 7 cylinders mutually touching [Bozóki et al. 2015]

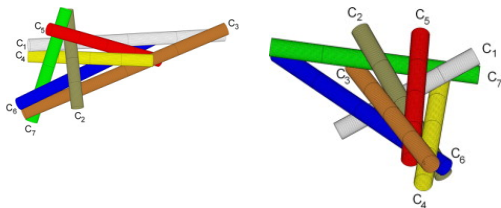

- Modeled with 20 equations in 20 variables
- Mixed volume 121 098 993 664
- First real solution after 80 000 000 paths
- Solution certified with Smale theorem

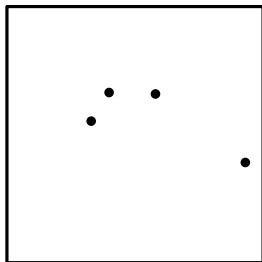

Test each cell

- 1 solution, guaranteed \Rightarrow keep
- 0 solution, guaranteed \Rightarrow remove
- don't know \Rightarrow subdivide

Complexity analysis: continuous amortization [Burr, Krahmer, Yap, 2009]

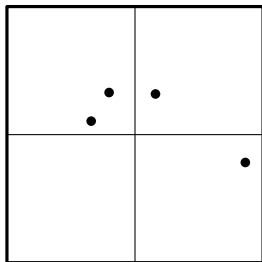

Test each cell

- 1 solution, guaranteed \Rightarrow keep
- 0 solution, guaranteed \Rightarrow remove
- don't know \Rightarrow subdivide

Complexity analysis: continuous amortization [Burr, Krahmer, Yap, 2009]

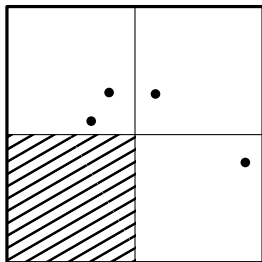

Test each cell

- 1 solution, guaranteed \Rightarrow keep
- 0 solution, guaranteed \Rightarrow remove
- don't know \Rightarrow subdivide

Complexity analysis: continuous amortization [Burr, Krahmer, Yap, 2009]

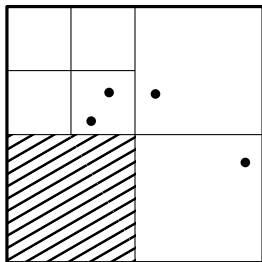

Test each cell

- 1 solution, guaranteed \Rightarrow keep
- 0 solution, guaranteed \Rightarrow remove
- don't know \Rightarrow subdivide

Complexity analysis: continuous amortization [Burr, Krahmer, Yap, 2009]

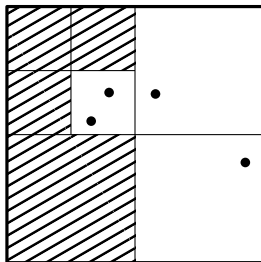

Test each cell

- 1 solution, guaranteed \Rightarrow keep
- 0 solution, guaranteed \Rightarrow remove
- don't know \Rightarrow subdivide

Complexity analysis: continuous amortization [Burr, Krahmer, Yap, 2009]

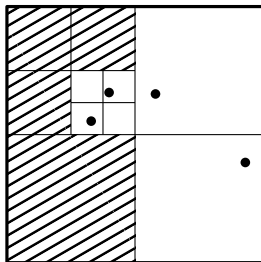

Test each cell

- 1 solution, guaranteed \Rightarrow keep
- 0 solution, guaranteed \Rightarrow remove
- don't know \Rightarrow subdivide

Complexity analysis: continuous amortization [Burr, Krahmer, Yap, 2009]

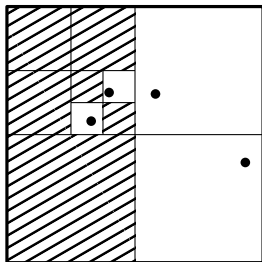

Test each cell

- 1 solution, guaranteed \Rightarrow keep
- 0 solution, guaranteed \Rightarrow remove
- don't know \Rightarrow subdivide

Complexity analysis: continuous amortization [Burr, Krahmer, Yap, 2009]

Further reading

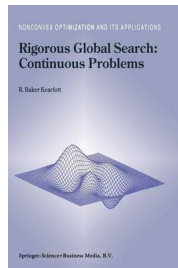
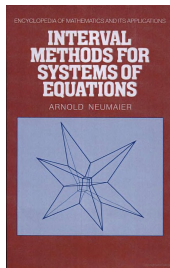
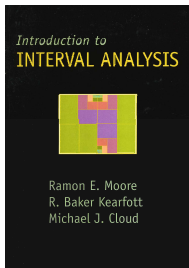
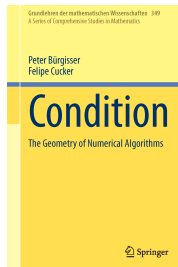
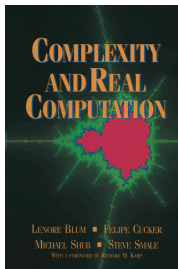

Path continuation

- Bertini (C++, Python) [Bates, Amethyst, Hauenstein, Sommese, Wampler]
- Hom4PS (C++) [Tien-Yien Li, Tianran Chen, Tsung-Lin Lee]
- PHCpack (Ada) [Vershelde]
- analyziz (mmx, C++) [van der Hoeven]
- ...

Subdivision multivariate

- ibex (C++) [Chabert]
- Realpaver (C) [Granvilliers]
- realroot (mmx, C++) [Mourrain]
- subdivision_solver (C++, Python) [Imbach]
- voxelize (C++) [M.]
- ...

Subdivision univariate

- ANewDsc (C) [Kobel, Rouillier, Sagraloff]
- Clenshaw (C, Python) [M.]
- Ccluster (C, Julia) [Imbach, Pan, Yap]
- real_roots (sage) [Witty]
- RS (C) [Rouillier]
- SLV (C) [Tsigaridas]
- ...

Drawing reliably the projection of the solution

- 1 Isotopy
- 2 Projection
- 3 Drawing reliably

Drawing hypersurfaces

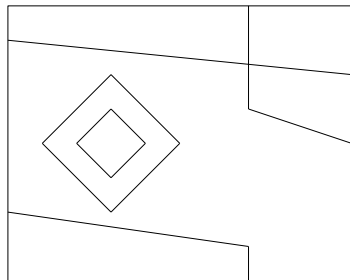
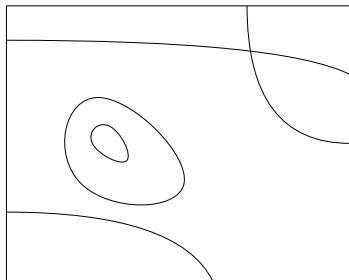

Definition (isotopy)

A triangulation T is isotope to $V \subset \mathbb{R}^n$ if there exists $\varphi : [0, 1] \times T \rightarrow \mathbb{R}^n$ such that:

- φ is continuous
- $\varphi(0, T) = T$ and $\varphi(1, T) = V$
- $\varphi_{t_0} : T \rightarrow \varphi(t_0, T)$ is an homeomorphism

Size of the triangulation [Kerber and Sagraloff 2011]

$f(x_1, \dots, x_n)$ of degree d

2 variables

Theorem

In the worst case $\Omega(d^2)$ vertices and $O(d^2)$ segments

3 variables

Theorem

In the worst case $\Omega(d^3)$ vertices and $O(d^5)$ triangles

n variables

Theorem

In the worst case $\Omega(d^n)$ vertices and $O(d^{3/4 \cdot 2^n - 1})$ simplices

Size of the triangulation [Kerber and Sagraloff 2011]

f of degree d and vertices on the surface

2 variables

Theorem

In the worst case $\Omega(d^{\cancel{2}^3})$ vertices and $O(d^{\cancel{2}^3})$ segments

3 variables

Theorem

In the worst case $\Omega(d^{\cancel{3}^4})$ vertices and $O(d^{\cancel{3}^7})$ triangles

n variables

Theorem

In the worst case $\Omega(d^{n+1})$ vertices and $O(d^{\cancel{3}^4} 2^{n-1})$ simplices

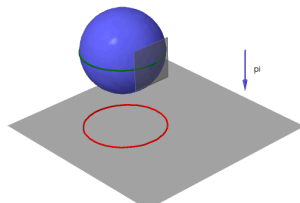
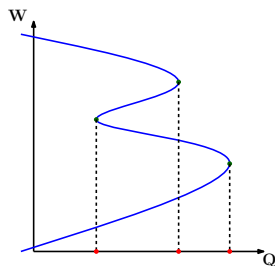

V solutions of $f_1 = \dots = f_k = \det\left(\frac{\partial f_i}{\partial x_j}\right) = 0$ in $\mathbb{R}^n \times \mathbb{R}^k$

Goal: draw the projection of V in Q

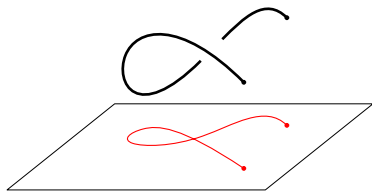

Definition (Semi-algebraic)

A **semi-algebraic** set is a set solution of a system of equalities and inequalities.

Theorem (Tarski-Seidenberg)

The projection of a semi-algebraic set is semi-algebraic.

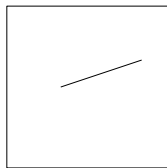
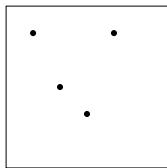
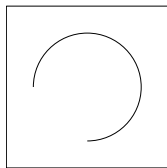

Definition (Zariski closure)

The **Zariski closure** of E is the minimal set \bar{E} containing E that is solution of a system of equalities.

Theorem (elimination)

- V solution of $p_1(q, x) = \dots = p_{k+1}(q, x) = 0$
- G Gröbner basis of F with respect to the lexdeg ordering with $x > q$
- G_q the polynomials in $\underline{G \cap \mathbb{Q}[q]}$
 $\Rightarrow \pi_Q(V) = \text{solutions of } G_q$

Projective elimination

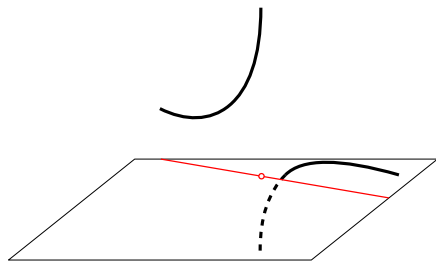

$$p_1(q, x) = \cdots = p_{k+1}(q, x) = 0$$

Theorem

If V_p is the projective closure of V in $\mathbb{C}^n \times \mathbf{P}_k$, then

$$\overline{\pi_Q(V)} = \pi_Q(V_p)$$

Geometry of the projection

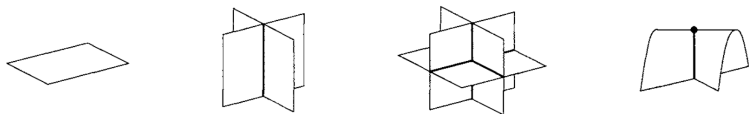

Figure 1: *Local singularities of images of generic maps of surfaces into 3-space*

[Guryonov 1997]

There exists a hypersurface $\Delta \subset C^\infty(M, \mathbb{R}^3)$ s.t. if $f \in C^\infty(M, \mathbb{R}^3) \setminus \Delta$, then the neighborhood of any point of $f(M)$ is one of the 4 above.

- Classification of generic singularities started with Whitney
- Thom introduced the transversality theorem
- Arnold and others provided numerous classifications

Geometry of the projection

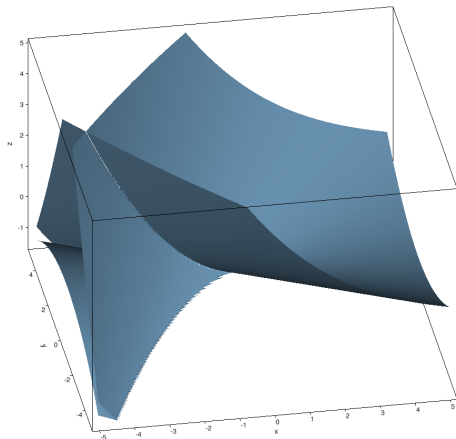

For the projection of critical points, we also have swallowtail singularities

Further reading

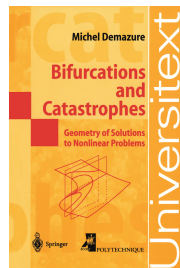
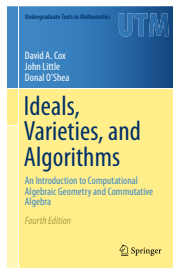
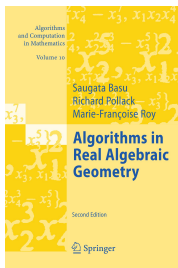

Quantifier elimination

- Redlog (Reduce)
- RegularChains (Maple)
- Resolve (Mathematica)
- QEPCAD (C)
- Tarski (C++)
- ...

[Dolzmann, Sturm]
[Moreno Maza et al]
[Strzebonski]
[Brown]
[Brown]

Satisfiability of formula

- RAGLib (Maple)
- RealCertify (Maple)
- RSolver (OCaml)
- TSSOS (Julia)
- ...

[Safey el Din]
[Magron, Safey el Din]
[Ratschan]
[Lassere, Magron, Wang]

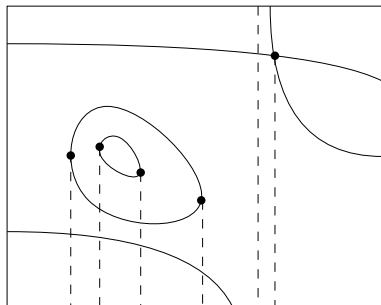

- Topology of curves in $\tilde{O}(d^6 + \tau d^5)$ operations
[Kobel, Sagraloff, 2015], [Niang Diatta, Diatta, Rouillier, Roy, Sagraloff, submitted 2018]
- Topology of surfaces with $O(d^5)$ simplices
[Berberich, Kerber, Sagraloff 2009]

Marching cubes [Lorensen and Cline 1987]

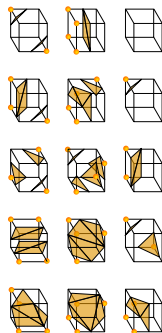
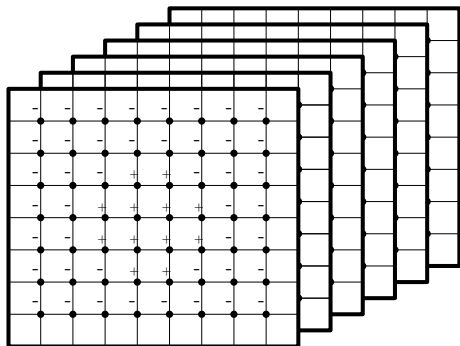

- 1 Evaluate $f(x, y, z)$ of deg d on a grid of size $N = n \times n \times n$
- 2 For each cube, compute a triangle of the surface to plot

Complexity: Cost of evaluating f on 1 point with Hörner: $O(d^3)$

Total naive: $O(d^3 n^3)$

Reuse computation by coordinates: $O(dn^3)$

Subdivision pruning

Interval arithmetic to remove boxes [Snyder 1992, Plantinga-Vegter 2006]

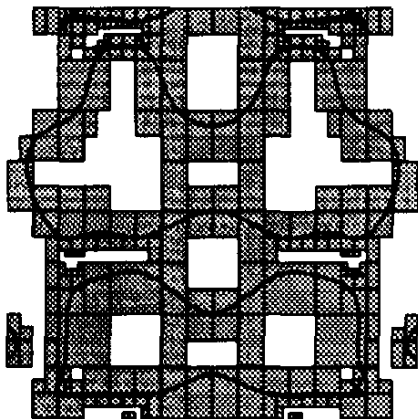
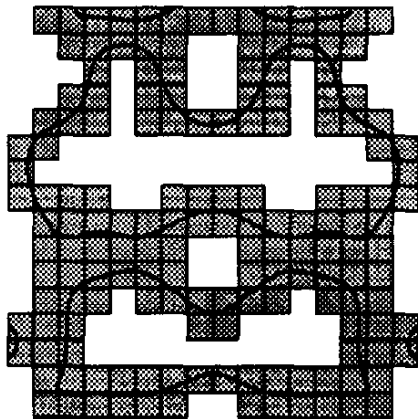

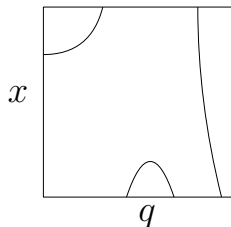

$$0 \notin \square \det(J_x(B)) = \square \det \left(\begin{array}{c} \frac{\partial f_i}{\partial x_j}(B) \end{array} \right)$$

$\Rightarrow V$ is globally parametrized by q in B

Surface tracking

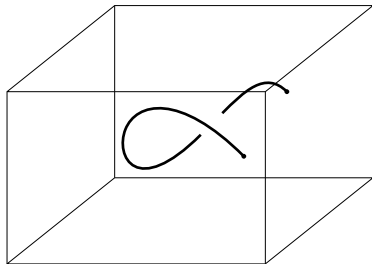

Regular case

- First marching segments [Dobkin et al. 1990]
- First marching triangles [Hilton et al. 1996]
- Recent result on marching simplices, topology guaranteed [Boissonnat, Kachanovich, Wintraecken, 2020]

Singular surfaces

- Use isosingular deflation near singularities [Bates, Brake, Hauenstein, Sommese, Wampler, 2014]

Further reading

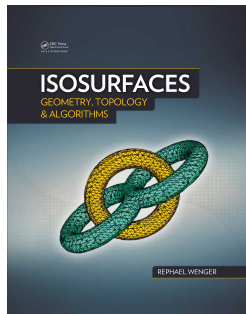
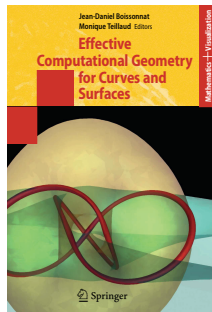

Further computing

Drawing with symbolic approach

- `algsolve` (Maple)
- `isotop` (C, Maple)
- `EXACUS` (C++)
- ...

[Deconink, Patterson, van Hoeij]
[Peñeranda, Pouget, Lazard, Rouillier]
[Melhorn et al]

Drawing with subdivision

- `axl` (C++, `mmx`)
- `ibex` (C++)
- `Realpaver` (C)
- `voxelize` (C++)
- ...

[Christoflorou, Mantzaflaris, Mourrain, Wintz]
[Chabert]
[Granvilliers]
[M.]

Drawing with marching cube

- `JuliaGeometry` (Julia)
- `scikit-image` (C, python)
- `MathMod` (C++)
- ...

[Kelly]
[Lewiner]
[Taha]

Drawing with continuation

- `bertini_real`
- `CGAL` (C++)
- `GUDHI` (C++)
- ...

[Brake et al]
[Rineau, Yvinec]
[Kachanovich]

Merci !

- Complexity of gröbner bases in dimension 3 with terse representation?
- What are the actual bounds on the number of simplices in drawings in 3D, in nD ?
- What if we use polynomial pieces of degree k instead of linear pieces?
- Reliable drawing of singular surfaces with prescribed singularities?