



HAL
open science

A Steerable Yagi-Uda Array Antenna Using a Substrate Integrated Waveguide Rotman Lens

Javad Pourahmadazar, Reza Karimian, Tayeb Denidni

► **To cite this version:**

Javad Pourahmadazar, Reza Karimian, Tayeb Denidni. A Steerable Yagi-Uda Array Antenna Using a Substrate Integrated Waveguide Rotman Lens. 2016 USNC-URSI Radio Science Meeting (Joint with AP-S Symposium), Jun 2016, Fajardo, United States. 10.1109/USNC-URSI.2016.7588489 . hal-04116654

HAL Id: hal-04116654

<https://hal.science/hal-04116654>

Submitted on 5 Jun 2023

HAL is a multi-disciplinary open access archive for the deposit and dissemination of scientific research documents, whether they are published or not. The documents may come from teaching and research institutions in France or abroad, or from public or private research centers.

L'archive ouverte pluridisciplinaire **HAL**, est destinée au dépôt et à la diffusion de documents scientifiques de niveau recherche, publiés ou non, émanant des établissements d'enseignement et de recherche français ou étrangers, des laboratoires publics ou privés.

**IN
RS**

**Institut national
de la recherche
scientifique**

**IN
RS**

**Institut national
de la recherche
scientifique**

Radio Frequency Laboratory (LRF)

Head of Lab:

Tayeb A. Denidni, Ph.D, IEEE Fellow
Scientific Head

Email: denidni@inrs.ca

Phone: [514-228-7017](tel:514-228-7017)

Titre : Antenne en réseau Yagi-Uda orientable utilisant une lentille Rotman à guide d'ondes intégré sur substrat

Auteurs : Javad Pourahmadazar; Reza Karimian; Tayeb Denidni

Résumé : Cet article présente une nouvelle antenne en réseau Yagi-Uda orientable de 8 à 12 GHz utilisant le guide d'ondes intégré sur substrat (SIW). Elle utilise une lentille à guide d'ondes intégrée de type Rotman comme réseau de formation de faisceau (BFN). La lentille micro-ondes proposée est une lentille intégrée de type Rotman réalisée sur un substrat. Un prototype de lentille est conçu avec 7 ports de faisceau, 9 ports de réseau et 8 ports fictifs. Une antenne Yagi-Uda alimentée en SIW de 10 GHz est proposée avec un élément directeur non planaire comme élément rayonnant. Tout au long de cet article, le processus de conception de l'antenne en réseau à phases orientables proposée pour une application de détection de 8 à 12 GHz est démontré en détail.

Mots-clés : antenne en réseau Yagi-Uda orientable, lentille Rotman à guide d'ondes intégré sur substrat, structure de lentille à guide d'ondes intégré sur substrat, réseau de formation de faisceau, BFN, conception de lentille, ports de faisceau, ports de réseau, ports fictifs, antenne Yagi-Uda alimentée en SIW, éléments rayonnants, élément directeur non planaire, antenne en réseau à phases orientables, application de détection micro-ondes, fréquence de 8 GHz à 12 GHz.

A Steerable Yagi-Uda Array Antenna Using a Substrate Integrated Waveguide Rotman Lens

Javad Pourahmadazar, Reza Karimian, and Tayeb Denidni

National Institute of Scientific Research (INRS)
Centre for Energy, Materials and Telecommunication
800, Rue De la Gauchetière Ouest Buro - 6900,
Montreal(QC) - H5A 1K6, CANADA
jpourahmadazar@ieee.org

Abstract— This paper presents a novel steerable 8-12 GHz Yagi-Uda array antenna using substrate integrated waveguide (SIW). It employs an integrated waveguide structure microwave Lens as a beam forming network (BFN). The proposed microwave lens is Rotman type integrated lens in substrate. A prototype lens is designed with 7 beam ports, 9 array ports, and 8 dummy ports. A 10 GHz SIW-fed Yagi-Uda antenna is proposed with nonplanar director element as radiating elements. Throughout this paper, the design process of the proposed steerable phase array antenna for 8-12 GHz sensing application has been demonstrated in details.

Keywords—Substrate Integrated Waveguide (SIW), Beam forming network (BFN), Rotman Lens, Multibeam antenna

I. INTRODUCTION

In recent years, Beam Forming Networks (BFNs) techniques such as Blass, Nolen and Butler matrices, Luneburg, R-KR and Rotman lenses, using substrate integrated waveguides for providing desired far field radiation pattern and pointing direction over the application bands have been developed to produce phased array and array antennas [1]-[9].

II. PHASED ARRAY ANTENNA DESIGN AND RESULTS

The generic block diagram of sensing multi-beam antennas consists of N radiators and M input ports by means of a beam forming network. This paper presents a novel steerable 8-12 GHz Yagi-Uda array antenna using substrate integrated waveguide (SIW) [9]. It employs an integrated waveguide structure microwave Lens as a beam forming network (BFN). The proposed microwave lens is Rotman type integrated lens in substrate. A prototype lens is designed with 7 beam ports, 9 array ports, and 8 dummy ports [2]-[4]. A 10 GHz SIW-fed Yagi-Uda antenna is proposed with nonplanar director element as radiating elements [2]-[4]. The simulated results around the center frequency for X-band application validate the proposed design and scanning capability over $\pm 24^\circ$. The full design process of the proposed phase array antenna is integrated with SIW technology [2]-[4]. In this work, a X-band lens with SIW technology is proposed to feed nine non-planar director Yagi-Uda antenna to generate multiple beams. The proffered steerable array antenna, which is comprised of seven beam ports, eight dummy ports and nine array ports, was designed to operate at the center frequency of 10-GHz, on an RO5880 substrate with electric permittivity of 2.2 and thickness of 0.508 mm [2]-[4]. The proposed Rotman lens

based steerable array antenna is designed for a nine linear non-directive Yagi radiation elements [2]-[4]. Seven beam ports were implemented in the proposed design to steer seven radiating beams at 0° , $\pm 8^\circ$, $\pm 16^\circ$ and $\pm 24^\circ$, respectively. In all previous lenses, the transverse electromagnetic (TEM) propagation incorporated in the design [2]-[4]. One of possible solution for that is to adopt the principle of a non-TEM parallel-plate propagation mode [2]-[4].

III. CONCLUSION

In this paper, a novel 8–12-GHz beam-shaping/steering phased antenna array System using SIW-fed nonplanar director Yagi-Uda antenna is presented.

REFERENCES

- [1] Y. J. Yu Cheng, W. Hong, K. Wu, Z. Q. Kuai, C. Yu, and J. X. Chen, "Substrate integrated waveguide (SIW) Rotman lens and its Ka-band multibeam array antenna applications," *IEEE Trans. Antennas Propag.*, vol. 56, no. 8, pp. 2504–2513, Aug. 2008.
- [2] J Pourahmadazar, TA Denidni, "Multi-beam tapered slot antenna array using substrate integrated waveguide Rotman lens", *Radar Conference (EuRAD)*, 2015 European, 425-428, 2015.
- [3] J Pourahmadazar, TA Denidni, "X-band substarte integrated Rotman Lens with $\pm 24^\circ$ scanning capability", APS, *USNC/URSI National Radio Science Meeting*, 2015.
- [4] J Pourahmadazar, TA Denidni, "X-band substarte integrated waveguide Rotman Lens", APS, *USNC/URSI National Radio Science Meeting*, 2015.
- [5] Xiong Zou, Chuang-Ming Tong, Jun-Song Bao and Wei-Jian Pang, "SIW-Fed Yagi Antenna and Its Application on Monopulse Antenna" *IEEE Antennas Propag. Lett.*, vol. 13, 2014.
- [6] Rafii, V., Nourinia, J., Ghobadi, C., Pourahmadazar, J., Virdee, B. S. "Broadband Circularly Polarized Slot Antenna Array Using Sequentially Rotated Technique For C-Band Applications", *IEEE, AWPL, J.*, vol. 12, p. 128-131, March, 2013.
- [7] Rafii, V.; Nourinia, J.; Pourahmadazar, J.; Jalili, J.; "Circularly Polarized Circular Slot Antenna Array Using Sequentially Rotated Feed Network", *Journal of Communication Engineering*, ISSN: 2322-3936 Vol. 1, No. 1, Oct 2012
- [8] Pourahmadazar, J.; Rafii, V.; "Broadband Circularly Polarized Slot Antenna Array for L and S-Band Applications", *Electronics Letters, J.*, Issue 10, vol. p.542-543, 17 May, 2012
- [9] Xiong Zou, Chuang-Ming Tong, Jun-Song Bao, and Wei-jian Pang, "SIW-Fed Yagi Antenna and its Application on Monopulse Antenna", *IEEE Antennas and Wireless Propagation Letters*, vol. 13, 2014.

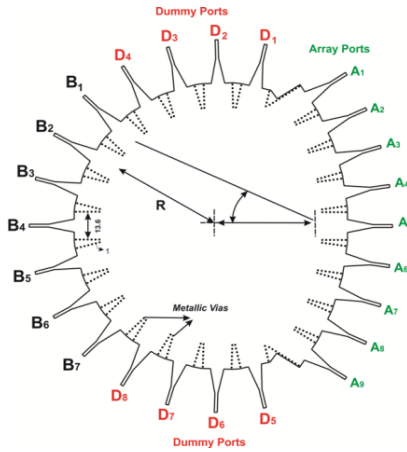
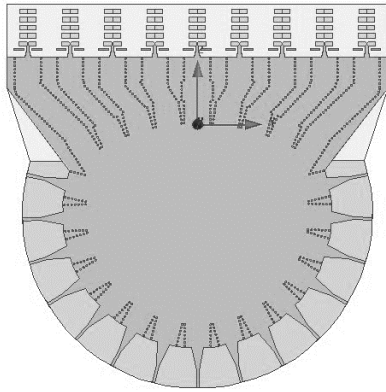

Fig. 1. Geometry of the proposed steerable Rotman lens array antenna

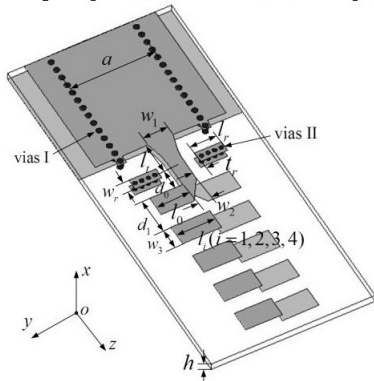

Fig. 2. Geometry of the proposed Single element Yagi-Uda, $a=10.4$, $h=0.508$, $w_1=3.1$, $w_2=1.7$, $r=12$, $d_1=4.6$, $l_0=4$, $l_1=4.75$, $l_2=4.65$, $l_3=4.55$, $l_4=4.45$, $l_r=3.3$ (All in mm).

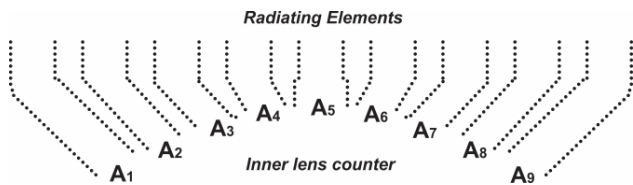

Fig. 3. Geometry of the proposed SIW phase shift network

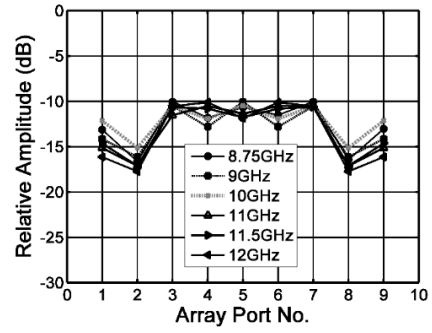

Fig. 4. Relative amplitude distribution across the array ports excited by B_4 beam port (0° beam port) of the SIW Rotman lens at 8.75, 9, 10, 11, 11.5 and 12 GHz, respectively.

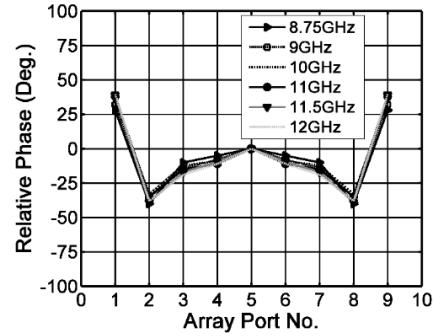

Fig. 5. Relative phase distribution across the array ports excited by B_4 beam port (0° beam port) of the SIW Rotman lens at 8.75, 9, 10, 11, 11.5 and 12 GHz, respectively.

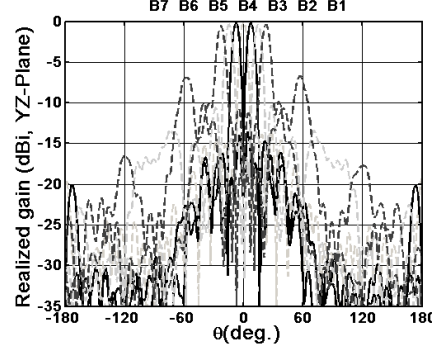
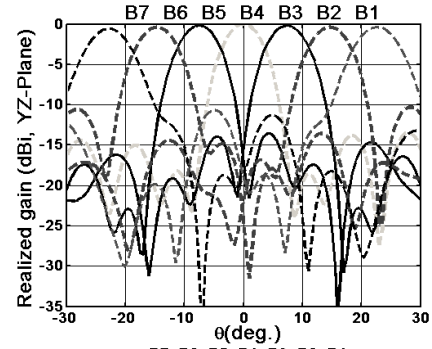

Fig. 6. Simulated 2-D gain patterns spectrum corresponding to B_1 ($+24^\circ$ beam port), B_2 ($+16^\circ$ beam port), B_3 ($+8^\circ$ beam port), B_4 (0° beam port), B_5 (-8° beam port), B_6 (-16° beam port) and B_7 (-24° beam port), beam ports at 10 GHz.

Related Works:

1. J. Pourahmadazar, C. Ghobadi, J. Nourinia, N. Felegari and H. Shirzad, "Broadband CPW-Fed Circularly Polarized Square Slot Antenna With Inverted-L Strips for UWB Applications," in IEEE Antennas and Wireless Propagation Letters, vol. 10, pp. 369-372, 2011, doi: 10.1109/LAWP.2011.2147271.
2. M. Farahani, J. Pourahmadazar, M. Akbari, M. Nedil, A. R. Sebak and T. A. Denidni, "Mutual Coupling Reduction in Millimeter-Wave MIMO Antenna Array Using a Metamaterial Polarization-Rotator Wall," in IEEE Antennas and Wireless Propagation Letters, vol. 16, pp. 2324-2327, 2017, doi: 10.1109/LAWP.2017.2717404.
3. S. R. Emadian, C. Ghobadi, J. Nourinia, M. H. Mirmozafari and J. Pourahmadazar, "Bandwidth Enhancement of CPW-Fed Circle-Like Slot Antenna With Dual Band-Notched Characteristic," in IEEE Antennas and Wireless Propagation Letters, vol. 11, pp. 543-546, 2012, doi: 10.1109/LAWP.2012.2199274.
4. J. Pourahmadazar, C. Ghobadi and J. Nourinia, "Novel Modified Pythagorean Tree Fractal Monopole Antennas for UWB Applications," in IEEE Antennas and Wireless Propagation Letters, vol. 10, pp. 484-487, 2011, doi: 10.1109/LAWP.2011.2154354.
5. N. Felegari, J. Nourinia, C. Ghobadi and J. Pourahmadazar, "Broadband CPW-Fed Circularly Polarized Square Slot Antenna With Three Inverted-L-Shape Grounded Strips," in IEEE Antennas and Wireless Propagation Letters, vol. 10, pp. 274-277, 2011, doi: 10.1109/LAWP.2011.2135832.
6. V. Rafii, J. Nourinia, C. Ghobadi, J. Pourahmadazar and B. S. Virdee, "Broadband Circularly Polarized Slot Antenna Array Using Sequentially Rotated Technique for CC-Band Applications," in IEEE Antennas and Wireless Propagation Letters, vol. 12, pp. 128-131, 2013, doi: 10.1109/LAWP.2013.2237744.
7. J. Pourahmadazar, C. Ghobadi, J. Nourinia and H. Shirzad, "Multiband Ring Fractal Monopole Antenna for Mobile Devices," in IEEE Antennas and Wireless Propagation Letters, vol. 9, pp. 863-866, 2010, doi: 10.1109/LAWP.2010.2071372.
8. Pourahmadazar, J.; Mohammadi, S.: 'Compact circularly-polarised slot antenna for UWB applications', Electronics Letters, 2011, 47, (15), p. 837-838, DOI: 10.1049/el.2011.1430
9. Pourahmadazar, J.; Rafii, V.: 'Broadband circularly polarised slot antenna array for L- and S-band applications', Electronics Letters, 2012, 48, (10), p. 542-543, DOI: 10.1049/el.2012.0294
10. S. Mohammadi, J. Nourinia, C. Ghobadi, J. Pourahmadazar and M. Shokri, "Compact Broadband Circularly Polarized Slot Antenna Using Two Linked Elliptical Slots for C-Band Applications," in IEEE Antennas and Wireless Propagation Letters, vol. 12, pp. 1094-1097, 2013, doi: 10.1109/LAWP.2013.2280457.
11. Pourahmadazar, J., Denidni, T.A. Towards Millimeter-wavelength: Transmission-Mode Fresnel-Zone Plate Lens Antennas using Plastic Material Porosity Control in Homogeneous Medium. *Sci Rep* 8, 5300 (2018). doi: [10.1038/s41598-018-23179-8](https://doi.org/10.1038/s41598-018-23179-8)
12. H. Boudaghi, J. Pourahmadazar and S. A. Aghdam, "Compact UWB monopole antenna with reconfigurable band notches using PIN diode switches," WAMICON 2013, Orlando, FL, USA, 2013, pp. 1-4, doi: 10.1109/WAMICON.2013.6572744.
13. J. Pourahmadazar and T. A. Denidni, "Multi-beam tapered slot antenna array using substrate integrated waveguide Rotman lens," 2015 European Microwave Conference (EuMC), Paris, France, 2015, pp. 1447-1450, doi: 10.1109/EuMC.2015.7346046.

14. Rezaeieh, S.A., Şimşek, S. and Pourahmadazar, J. (2013), Design of a compact broadband circularly-polarized slot antenna for wireless applications. *Microw. Opt. Technol. Lett.*, 55: 413-418. <https://doi.org/10.1002/mop.27303>
15. J. Pourahmadazar, S. Sahebghalam, S. Abazari Aghdam and M. Nouri, "A Millimeter-Wave Fresnel Zone Plate Lens Design Using Perforated 3D Printing Material," 2018 IEEE MTT-S International Microwave Workshop Series on Advanced Materials and Processes for RF and THz Applications (IMWS-AMP), Ann Arbor, MI, USA, 2018, pp. 1-3, doi: 10.1109/IMWS-AMP.2018.8457170.
16. J. Pourahmadazar and T. Denidni, "X-band substrate integrated Rotman Lens with $\pm 24^\circ$ scanning capability," 2015 IEEE International Symposium on Antennas and Propagation & USNC/URSI National Radio Science Meeting, Vancouver, BC, Canada, 2015, pp. 232-233, doi: 10.1109/APS.2015.7304502.
17. B. Zarghooni, A. Dadgarpour, J. Pourahmadazar and T. A. Denidni, "Supershaped metamaterial unit-cells using the gielis formula," 2015 IEEE International Symposium on Antennas and Propagation & USNC/URSI National Radio Science Meeting, Vancouver, BC, Canada, 2015, pp. 458-459, doi: 10.1109/APS.2015.7304615.
18. Pourahmadazar, J, Denidni, TA. Millimeter-wave planar antenna on flexible polyethylene terephthalate substrate with water base silver nanoparticles conductive ink. *Microw Opt Technol Lett.* 2018; 60: 887– 891. <https://doi.org/10.1002/mop.31079>
19. J. Pourahmadazar and T. A. Denidni, "High Gain Substrate Integrated Waveguide Resonant Slot Antenna Array for mm-Wave Band Radio," 2015 IEEE International Conference on Ubiquitous Wireless Broadband (ICUWB), Montreal, QC, Canada, 2015, pp. 1-4, doi: 10.1109/ICUWB.2015.7324455.
20. J. Pourahmadazar, H. Shirzad, C. Ghobadi and J. Nourinia, "Using a MAM and genetic algorithm to optimize UWB microstrip monopole antenna with FEM and HFSS," 2010 5th International Symposium on Telecommunications, Tehran, Iran, 2010, pp. 115-119, doi: 10.1109/ISTEL.2010.5734009.
21. Rafii Vahid, Nourinia Javad, Javad Pourahmadazar, Jalili Faramarz. Circularly Polarized Circular Slot Antenna Array Using Sequentially Rotated Feed Network. *Journal of Communication Engineering*, 2012, 1 (1), pp.38-46. [ffhal-03914171f](https://doi.org/10.1002/mop.31079)
22. Pourahmadazar, J, Denidni, TA. 60 GHz antenna array for millimeter-wave wireless sensor devices using silver nanoparticles ink mounted on a flexible polymer substrate. *Microw Opt Technol Lett.* 2017; 59: 2830– 2835. <https://doi.org/10.1002/mop.30834>
23. M. Dashti Ardakani, J. Pourahmadazar and S. O. Tatu, "A monopole antenna with notch-frequency function for UWB application," 2017 XXXIInd General Assembly and Scientific Symposium of the International Union of Radio Science (URSI GASS), Montreal, QC, Canada, 2017, pp. 1-4, doi: 10.23919/URSIGASS.2017.8105323.
24. J. Pourahmadazar, M. Dashti Ardakani, S. O. Tatu and T. A. Denidni, "V-band dipole phased array antennas on extended hemispherical dielectric lenses," 2017 XXXIInd General Assembly and Scientific Symposium of the International Union of Radio Science (URSI GASS), Montreal, QC, Canada, 2017, pp. 1-4, doi: 10.23919/URSIGASS.2017.8105327.
25. Shirzad, H. ., Virdee, B. ., Ghobadi, C. ., Shokri, M. ., Sedghi, T. ., Asiaban, S. ., & Pourahmadazar, . J. . (2021). Bandwidth Enhancement of Compact Planar Microstrip Antenna. *The Applied Computational Electromagnetics Society Journal (ACES)*, 28(05), 441–445.
26. J. Pourahmadazar, R. Karimian and T. Denidni, "8–12-GHz beam-shaping/steering phased antenna array system using SIW fed nonplanar director Yagi-Uda antenna," 2016 IEEE International

- Symposium on Antennas and Propagation (APSURSI), Fajardo, PR, USA, 2016, pp. 1145-1146, doi: 10.1109/APS.2016.7696280.
27. J. Pourahmadazar and T. A. Denidni, "X-band substrate integrated waveguide Rotman Lens," 2015 USNC-URSI Radio Science Meeting (Joint with AP-S Symposium), Vancouver, BC, Canada, 2015, pp. 188-188, doi: 10.1109/USNC-URSI.2015.7303472.
 28. J. Pourahmadazar, M. Farahani and T. Denidni, "Printed Ridge Gap Waveguide Rotman Lens for Millimetre-wave Applications," 2018 18th International Symposium on Antenna Technology and Applied Electromagnetics (ANTEM), Waterloo, ON, Canada, 2018, pp. 1-2, doi: 10.1109/ANTEM.2018.8572972.
 29. J. Pourahmadazar, R. Karimian, M. Farahani and T. Denidni, "Planar microwave lens based beam-forming phased antenna array system using non-coplanar SIW fed bowtie antenna," 2016 17th International Symposium on Antenna Technology and Applied Electromagnetics (ANTEM), Montreal, QC, Canada, 2016, pp. 1-4, doi: 10.1109/ANTEM.2016.7550154.
 30. J. Pourahmadazar, R. Karimian and T. Denidni, "A steerable Yagi-Uda array antenna using a substrate integrated waveguide Rotman lens," 2016 USNC-URSI Radio Science Meeting, Fajardo, PR, USA, 2016, pp. 15-16, doi: 10.1109/USNC-URSI.2016.7588489.
 31. R. Karimian, J. Pourahmadazar, M. Nedil and T. A. Denidni, "On the design of low SAR CPW antenna with magneto dielectric AMC based ground plane," 2016 10th European Conference on Antennas and Propagation (EuCAP), Davos, Switzerland, 2016, pp. 1-5, doi: 10.1109/EuCAP.2016.7481411.
 32. Y. Yousefzadeh, J. Pourahmadazar and S. A. Aghdam, "Compact UWB microstrip BPF using meander line resonator," 2013 IEEE Antennas and Propagation Society International Symposium (APSURSI), Orlando, FL, USA, 2013, pp. 802-803, doi: 10.1109/APS.2013.6711060.
 33. R. Amiri, B. Zarghooni, A. Dadgarpour, J. Pourahmadazar and T. A. Denidni, "Reconfigurable metamaterial unit-cell with controllable refractive index," 2016 17th International Symposium on Antenna Technology and Applied Electromagnetics (ANTEM), Montreal, QC, Canada, 2016, pp. 1-2, doi: 10.1109/ANTEM.2016.7550155.
 34. M. Farahani, J. Zaid, J. Pourahmadazar, T. A. Denidni and M. Nedil, "Millimeter-wave corrugated surface for mutual coupling reduction between dipole antennas," 2016 17th International Symposium on Antenna Technology and Applied Electromagnetics (ANTEM), Montreal, QC, Canada, 2016, pp. 1-2, doi: 10.1109/ANTEM.2016.7550158.
 35. R. Amiri, B. Zarghooni, A. Dadgarpour, J. Pourahmadazar and T. A. Denidni, "Anisotropic metamaterial unit-cell for millimeter-wave applications," 2016 17th International Symposium on Antenna Technology and Applied Electromagnetics (ANTEM), Montreal, QC, Canada, 2016, pp. 1-2, doi: 10.1109/ANTEM.2016.7550179.
 36. J. Pourahmadazar, R. Karimian and T. A. Denidni, "A High Data-Rate Kiosk Application circularly polarized fractal antenna for mm-wave band radio with 0.18 μ m CMOS technology," 2016 10th European Conference on Antennas and Propagation (EuCAP), Davos, Switzerland, 2016, pp. 1-4, doi: 10.1109/EuCAP.2016.7481317.
 37. Jalili Faramarz, Javad Pourahmadazar, Rafii Vahid, Nourinia Javad, "Circularly Polarized Circular Slot Antenna Array Using Sequentially Rotated Feed Network". *Journal of Communication Engineering*, 2012, 1 (1), pp.38-46.
 38. J. Pourahmadazar and T. Denidni, "V-band Printed Ridge Gap Waveguide Phased Array Antenna with $\pm 40^\circ$ Scanning Angular Sector and ETSI Class II Radiation Pattern," 2018 18th International

- Symposium on Antenna Technology and Applied Electromagnetics (ANTEM), Waterloo, ON, Canada, 2018, pp. 1-2, doi: 10.1109/ANTEM.2018.8572992.
39. M. Farahani, J. Pourahmadazar, T. Denidni and M. Nedil, "Millimeter-Wave High-Gain Ridge Gap Beam Steerable Antenna for 5G wireless Networks," 2018 18th International Symposium on Antenna Technology and Applied Electromagnetics (ANTEM), Waterloo, ON, Canada, 2018, pp. 1-2, doi: 10.1109/ANTEM.2018.8572923.
 40. R. Karimian, J. Pourahmadazar, T. A. Denidni and M. Nedil, "Free space mutual coupling reduction between two SIW antennas at millimeter-wave frequency," 2016 IEEE International Symposium on Antennas and Propagation (APSURSI), Fajardo, PR, USA, 2016, pp. 2183-2184, doi: 10.1109/APS.2016.7696798.
 41. J. Pourahmadazar, R. Karimian, M. Farahani and T.A. Denidni, "10GHz Microwave Lens based Beam-forming Phased Antenna Array System Using SIW Fed Bow-tie antenna", *ANTEM*, 2016.
 42. R. Karimian, M. Dashti, J. Pourahmadazar, S. Ahmadi and M. Zaghoul, "Non-Reciprocal Phased Array antenna," 2021 XXXIVth General Assembly and Scientific Symposium of the International Union of Radio Science (URSI GASS), Rome, Italy, 2021, pp. 1-3, doi: 10.23919/URSIGASS51995.2021.9560450.
 43. M. D. Ardakani, R. Karimian, J. Pourahmadazar, S. Tatu, S. Ahmadi and M. Zaghoul, "Characterization of a Highly Efficient Waveguide Front-End Direct-Conversion Receiver for 60-GHz Wireless Systems," 2021 IEEE International Symposium on Antennas and Propagation and USNC-URSI Radio Science Meeting (APS/URSI), Singapore, Singapore, 2021, pp. 529-530, doi: 10.1109/APS/URSI47566.2021.9703708.
 44. J. Pourahmadazar, R. Karimian, M. D. Ardakani, S. Ahmadi and M. Zaghoul, "Alumide as a Nonmagnetic Fresnel Zone Lens at 30 GHz," 2021 XXXIVth General Assembly and Scientific Symposium of the International Union of Radio Science (URSI GASS), Rome, Italy, 2021, pp. 1-3, doi: 10.23919/URSIGASS51995.2021.9560347.
 45. M. D. Ardakani, R. Karimian, J. Pourahmadazar, S. Tatu, S. Ahmadi and M. Zaghoul, "Compact Parallel Coupled-Line Bandpass Filter Dedicated to S-Band Homodyne Front-End Radars," 2021 IEEE International Symposium on Antennas and Propagation and USNC-URSI Radio Science Meeting (APS/URSI), Singapore, Singapore, 2021, pp. 1391-1392, doi: 10.1109/APS/URSI47566.2021.9704419.
 46. Nader Felegari, Javad Pourahmadazar. A Novel Coaxial-fed Wide Band Circularly Polarised Patch Antenna for WLAN/ WiMax Applications. *International Journal of Natural and Engineering Sciences*, 2019, 5 (2), pp.11. fhal-03914172f
 47. Pourahmadazar, J., Denidni, T.A. Author Correction: Towards Millimeter-wavelength: Transmission-Mode Fresnel-Zone Plate Lens Antennas using Plastic Material Porosity Control in Homogeneous Medium. *Sci Rep* 8, 10293 (2018). <https://doi.org/10.1038/s41598-018-28407-9>
 48. J. Pourahmadazar and T. A. Denidni, "Extended hemispherical integrated lens antenna for F-band application," 2017 XXXIInd General Assembly and Scientific Symposium of the International Union of Radio Science (URSI GASS), Montreal, QC, Canada, 2017, pp. 1-2, doi: 10.23919/URSIGASS.2017.8105165.
 49. R. Amiri, B. Zarghooni, J. Pourahmadazar and T. A. Denidni, "The fabrication and test of paraffin-based dielectric lenses for metamaterial characterization using the free-space method for 10–18 GHz," 2017 11th European Conference on Antennas and Propagation (EuCAP), Paris, France, 2017, pp. 3235-3238, doi: 10.23919/EuCAP.2017.7928499.

50. J. Pourahmadazar, R. Karimian and M. D. Ardakani, "Towards E-band Wavelength: 3D Printed Gaussian Corrugated Horn for Cassegrain Antenna Application," 2022 United States National Committee of URSI National Radio Science Meeting (USNC-URSI NRSM), Boulder, CO, USA, 2022, pp. 86-87, doi: 10.23919/USNC-URSINRSM57467.2022.9881470.
51. Yousefzadeh, Y., Pourahmadazar, J. and Aghdam, S., 2013, January. 312.10: COMPACT UWB MICROSTRIP BPF USING MEANDER LINE RESONATOR. In *INTERNATIONAL SYMPOSIUM DIGEST ANTENNAS AND PROPAGATION* (Vol. 1, No. 2, pp. 802-802). IEEE.
52. Yasin Yousefzadeh, Javad Pourahmadazar. Compact Low Pass Filter using Inter-Digital Loaded Defected Rectangular Stub Resonators. *International journal of Microwave and Optical Technology*, 2012, 7 (1), pp.35-38. fhal-03914108f
53. Pourahmadazar, Javad (2018). *Nouvelles antennes millimétriques à lentille utilisant des structures périodiques poreuses en plastique*. Thèse. Québec, Université du Québec, Institut national de la recherche scientifique, Doctorat en télécommunications, 196 p.
54. Javad Pourahmadazar. NEW MILLIMETRIC LENS ANTENNAS USING PERIODIC POROUS PLASTIC STRUCTURES. Engineering Sciences [physics]. Université du Québec, Institut national de la recherche scientifique,, 2018. English. (NNT :). (tel-03911562)
55. Javad Pourahmadazar. Design and Fabrication of a Novel UWB Antenna with New Geometrical Structures (Fractal and Euclidean). Engineering Sciences [physics]. Urmia University, 2011. English.
56. Javad Pourahmadazar. Towards BLUETOOTH: TECHNOLOGY, APPLICATIONS, and ANTENNAS. Engineering Sciences [physics]. Urmia University, 2011. English.
57. Javad Pourahmadazar. Towards Fractal Antennas: A multiband Sierpinski Triangle (Gasket) Fractal Vivaldi Antenna. Institut National de la Recherche Scientifique [Québec]. 2023, pp.38. (hal-03974528)
58. R. Karimian, Javad Pourahmadazar, T. Denidni, Mourad Nedil. Réduction de couplage mutuel sans fil entre deux antennes SIW à fréquence millimétrique. 2016 IEEE International Symposium on Antennas and Propagation & USNC/URSI National Radio Science Meeting, Jun 2016, Fajardo, United States. pp.2183-2184, ff10.1109/APS.2016.7696798ff. fhal-04116343f
59. R. Karimian, Javad Pourahmadazar, T. Denidni, Mourad Nedil. Réduction de couplage mutuel sans fil entre deux antennes SIW à fréquence millimétrique. 2016 IEEE International Symposium on Antennas and Propagation & USNC/URSI National Radio Science Meeting, Jun 2016, Fajardo, United States. pp.2183-2184, ff10.1109/APS.2016.7696798ff. fhal-04116343f
60. Javad Pourahmadazar, Reza Karimian, Tayeb Denidni. Système de réseau d'antennes à commande de formation de faisceau/de direction à 8-12 GHz utilisant une antenne Yagi-Uda avec alimentation par guide d'ondes intégré à substrat. 2016 IEEE International Symposium on Antennas and Propagation & USNC/URSI National Radio Science Meeting, Jun 2016, Fajardo, United States. pp.1145-1146, ff10.1109/APS.2016.7696280ff. fhal-04116024
61. Javad Pourahmadazar, Reza Karimian, Tayeb Denidni. 8–12-GHz beam-shaping/steering phased antenna array system using SIW fed nonplanar director Yagi-Uda antenna. 2016 IEEE International Symposium on Antennas and Propagation & USNC/URSI National Radio Science Meeting, Jun 2016, Fajardo, United States. pp.1145-1146, ff10.1109/APS.2016.7696280ff. fhal-04116007f
62. Mohammadmahdi Farahani, Jamal Zaid, Javad Pourahmadazar, Tayeb Denidni, Mourad Nedil. Surface ondulée à ondes millimétriques pour la réduction du couplage mutuel entre antennes dipôles. 2016 17th International Symposium on Antenna Technology and Applied Electromagnetics (ANTEM), Jul 2016, Montreal, Canada. pp.1-2, (10.1109/ANTEM.2016.7550158). (hal-04116347)

63. Mohammadmahdi Farahani, Jamal Zaid, Javad Pourahmadazar, Tayeb Denidni, Mourad Nedil. Millimeter-wave corrugated surface for mutual coupling reduction between dipole antennas. 2016 17th International Symposium on Antenna Technology and Applied Electromagnetics (ANTEM), Jul 2016, Montreal, Canada. pp.1-2, [\(10.1109/ANTEM.2016.7550158\)](#). [\(hal-04116344\)](#)
64. Javad Pourahmadazar, Reza Karimian, Mohammadmahdi Farahani, Tayeb Denidni. Système de réseau d'antennes à formation de faisceaux basé sur une lentille micro-onde plane utilisant une antenne Bowtie alimentée par SIW non coplanaire. 2016 17th International Symposium on Antenna Technology and Applied Electromagnetics (ANTEM), Jul 2016, Montreal, Canada. pp.1-4, [\(10.1109/ANTEM.2016.7550154\)](#)
65. Javad Pourahmadazar, Mohammadmahdi Farahani, Tayeb Denidni. Lentille Rotman à guide d'ondes imprimé avec encoche pour applications en ondes millimétriques. 2018 18th International Symposium on Antenna Technology and Applied Electromagnetics (ANTEM), Aug 2018, Waterloo, Canada. pp.1-2, [\(10.1109/ANTEM.2018.8572972\)](#)
66. Javad Pourahmadazar, Tayeb Denidni. Lentille Rotman intégrée au substrat en bande X avec une capacité de balayage de $\pm 24^\circ$. 2015 IEEE International Symposium on Antennas and Propagation & USNC/URSI National Radio Science Meeting, Jul 2015, Vancouver, Canada. pp.232-233, [\(10.1109/APS.2015.7304502\)](#)
67. Hamid Boudaghi, Javad Pourahmadazar, Sajjad Abazari Aghdam. Antenne monopôle UWB compacte avec encoches de bande reconfigurables utilisant des commutateurs à diode PIN. 2013 IEEE 14th Annual Wireless and Microwave Technology Conference (WAMICON), Apr 2013, Orlando, United States. pp.1-4, [\(10.1109/WAMICON.2013.6572744\)](#)
68. Javad Pourahmadazar, Tayeb Denidni. V-band Printed Ridge Gap Waveguide Phased Array Antenna with $\pm 40^\circ$ Scanning Angular Sector and ETSI Class II Radiation Pattern. 2018 18th International Symposium on Antenna Technology and Applied Electromagnetics (ANTEM), Aug 2018, Waterloo, Canada. pp.1-2, [\(10.1109/ANTEM.2018.8572992\)](#)
69. Javad Pourahmadazar, Tayeb Denidni. Antenne en réseau à formation de faisceaux V-band à guides d'ondes imprimés en ondulation de crête avec secteur angulaire de balayage de $\pm 40^\circ$ et motif de rayonnement de classe II ETSI. 2018 18th International Symposium on Antenna Technology and Applied Electromagnetics (ANTEM), Aug 2018, Waterloo, Canada. [\(10.1109/ANTEM.2018.8572992\)](#). [\(hal-04116388\)](#)
70. Reza Amiri, Behnam Zarghooni, Javad Pourahmadazar, Tayeb Denidni. Fabrication et test de lentilles diélectriques à base de paraffine pour la caractérisation des métamatériaux utilisant la méthode en espace libre de 10 à 18 GHz. 2017 11th European Conference on Antennas and Propagation (EuCAP), Mar 2017, Paris, France. pp.3235-3238, [\(10.23919/EuCAP.2017.7928499\)](#). [\(hal-04116390\)](#)
71. Javad Pourahmadazar, Tayeb Denidni. Réseau d'antennes à fente effilée multi-faisceaux utilisant une lentille Rotman intégrée au substrat. 2015 European Radar Conference (EuRAD), Sep 2015, Paris, France. pp.425-428, [\(10.1109/EuRAD.2015.7346328\)](#)
72. Javad Pourahmadazar, Tayeb Denidni. Multi-beam tapered slot antenna array using substrate integrated waveguide Rotman lens. 2015 European Microwave Conference (EuMC 2015), Sep 2015, Paris, France. pp.1447-1450, [\(10.1109/EuMC.2015.7346046\)](#)
73. Javad Pourahmadazar, T. Denidni. Lentille de Rotman intégrée à un guide d'ondes à substrat de bande X. 2015 USNC-URSI Radio Science Meeting (Joint with AP-S Symposium), Jul 2015, Vancouver, Canada. pp.188-188, [\(10.1109/USNC-URSI.2015.7303472\)](#)

74. Javad Pourahmadazar, T. Denidni. X-band substarate integrated waveguide Rotman Lens. 2015 USNC-URSI Radio Science Meeting (Joint with AP-S Symposium), Jul 2015, Vancouver, France. pp.188-188, [\(10.1109/USNC-URSI.2015.7303472\)](#)
75. Javad Pourahmadazar, Changiz Ghobadi, Javad Nourinia. Using a MAM and genetic algorithm to optimize UWB microstrip monopole antenna with FEM and HFSS. 2010 5th International Symposium on Telecommunications (IST), Dec 2010, Tehran, Iran. pp.115-119, [\(10.1109/ISTEL.2010.5734009\)](#)
76. Javad Pourahmadazar, Hamed Shirzad, Changiz Ghobadi, Javad Nourinia. Utilisation d'une MAM et d'un algorithme génétique pour optimiser une antenne monopôle à microbande UWB avec FEM et HFSS . 2010 5th International Symposium on Telecommunications (IST), Dec 2010, Tehran, Iran. pp.115-119
77. Behnam Zarghooni, Abdolmehdi Dadgarpour, Javad Pourahmadazar, Tayeb Denidni. Unités cellulaires de métamatériaux superformés utilisant la formule de Gielis. 2015 IEEE International Symposium on Antennas and Propagation & USNC/URSI National Radio Science Meeting, Jul 2015, Vancouver, Canada. pp.458-459, [\(10.1109/APS.2015.7304615\)](#)
78. Behnam Zarghooni, Abdolmehdi Dadgarpour, Javad Pourahmadazar, Tayeb Denidni. Supershaped metamaterial unit-cells using the gielis formula. 2015 IEEE International Symposium on Antennas and Propagation & USNC/URSI National Radio Science Meeting, Jul 2015, Vancouver, France. pp.458-459, [\(10.1109/APS.2015.7304615\)](#)
79. Reza Karimian, Javad Pourahmadazar, Mourad Nedil, Tayeb Denidni. Conception d'une antenne CPW à faible SAR avec un plan de masse AMC à base de magnéto-diélectrique. 2016 10th European Conference on Antennas and Propagation (EuCAP), Apr 2016, Davos, Swaziland. pp.1-5, [\(10.1109/EuCAP.2016.7481411\)](#)
80. Javad Pourahmadazar, Tayeb Denidni. Réseau d'antennes à fentes résonantes à guide d'ondes intégré sur substrat à gain élevé pour les radios en bande mm. 2015 IEEE International Conference on Ubiquitous Wireless Broadband (ICUWB), Oct 2015, Montreal, Canada. pp.1-4, [\(10.1109/ICUWB.2015.7324455\)](#). [\(hal-04116650\)](#)
81. Hamid Boudaghi, Javad Pourahmadazar, Sajjad Abazari Aghdam. Compact UWB monopole antenna with reconfigurable band notches using PIN diode switches. 2013 IEEE International Symposium on Antennas and Propagation & USNC/URSI National Radio Science Meeting, Jul 2013, Orlando, United States. pp.1758-1759, [\(10.1109/APS.2013.6711538\)](#)
82. Hamid Boudaghi, Javad Pourahmadazar, Sajjad Abazari Aghdam. Antenne monopôle UWB compacte avec encoches de bande reconfigurables utilisant des interrupteurs à diode PIN. 2013 IEEE 14th Annual Wireless and Microwave Technology Conference (WAMICON), Apr 2013, Orlando, United States. pp.1-4, [\(10.1109/WAMICON.2013.6572744\)](#)