



HAL
open science

Thermal modeling of the occupied multi-zone buildings taking into account the uncertainties of occupant behavior

Walid Belazi, Salah-Eddine Ouldboukhitine, Alaa Chateauneuf, Abdelhamid Bouchair

► To cite this version:

Walid Belazi, Salah-Eddine Ouldboukhitine, Alaa Chateauneuf, Abdelhamid Bouchair. Thermal modeling of the occupied multi-zone buildings taking into account the uncertainties of occupant behavior. *Case Studies in Thermal Engineering*, 2022, 33, pp.101978. 10.1016/j.csite.2022.101978. hal-04116628

HAL Id: hal-04116628

<https://hal.science/hal-04116628>

Submitted on 22 Jul 2024

HAL is a multi-disciplinary open access archive for the deposit and dissemination of scientific research documents, whether they are published or not. The documents may come from teaching and research institutions in France or abroad, or from public or private research centers.

L'archive ouverte pluridisciplinaire **HAL**, est destinée au dépôt et à la diffusion de documents scientifiques de niveau recherche, publiés ou non, émanant des établissements d'enseignement et de recherche français ou étrangers, des laboratoires publics ou privés.



Distributed under a Creative Commons Attribution - NonCommercial 4.0 International License

Thermal modeling of the occupied multi-zone buildings taking into account the uncertainties of occupant behavior

Walid Belazi, Salah-Eddine Ouldboukhitine, Alaa Chateaneuf, Abdelhamid Bouchair

Université Clermont Auvergne, CNRS, SIGMA Clermont, Institut Pascal, F-63000 Clermont-Ferrand, France

Abstract

In this paper, the interaction between residential apartments in the same building is considered by including the occupant behavior. The study is applied to three-floor residential building. First, a multi-zone building model was implemented and validated by comparison with thermal simulation tools. Deterministic study allows us to determine the worst case of energy highest consumption. The interior insulation thickness is then progressively increased to obtain its optimal value with respect to heat loss and equilibrated energy consumption between apartments. Finally, a random variation of family absence number and duration has been applied to evaluate their influence on energy demand considering heat interaction between apartments.

Keywords: building, energy performance, uncertainties, occupant behavior.

1. Introduction

At present, population growth and rising living standards are the principal source of increased energy demand worldwide [1, 2]. In the building sector, the greatest potential for energy savings lies in reducing heating and cooling [3]. Therefore, it is considered a major energy consumer and source of pollution among all economic sectors [4].

In 2016, the building sector accounted for almost 40% of total global energy consumption and 33% of total greenhouse gas (GHG) emissions [5], which would be even higher if the energy consumption for the whole life cycle of buildings was considered [6-8]. In France, the building sector is responsible for 44% of total national energy consumption and generates around 21.9% of total CO₂ emissions [9].

Currently, the main challenge is to reduce CO₂ emissions to achieve decarbonization of the building sector. To achieve this, the United States of America (USA) has targets to reduce GHG emissions by 17% by 2020 and 26-28% by 2025, compared to 2005. Regarding the European Union (EU), its target is to reduce GHG emissions by 40% by 2030 compared to 1990 [10].

This increase is notably linked to the development of housing (the appearance of innovative energy-consuming technologies) and to changes in occupant comfort. In other terms, the occupant consumes energy for his comfort and daily activities inside his building. To reduce this consumption, the occupant must first think about changing their behavior.

1.1 Energy consumption in the residential sector

In this section, we propose to present an overview of the energy consumption related to the residential sector¹. In 2015, the Energy Information Administration (EIA) report indicated that the building sector includes the residential and commercial sectors (EIA, 2016). Indeed, any place where people live is considered a residential building. However, commercial buildings include offices, shops, hospitals, restaurants and schools.

The residential sector consumes much more energy than commercial sector and is responsible for over 40% of total CO₂ emissions from buildings [11]. Heating, ventilation and cooling (HVAC) are the main subsystems contributing to the energy consumption, accounting for 43% of residential energy consumption in the United States of America (USA) and 61% in Canada. In France, heating and cooling are the largest contributors to energy consumption (60%), accompanied by domestic hot water (20%) and lighting and auxiliary equipment (10%) [11].

In residential buildings, the energy performance is influenced by a variety of factors, such as physical characteristics (orientation, surface, insulation materials...), internal systems (heating, cooling and ventilation systems), external environment (temperature, solar flux and humidity) and especially its occupants [12]. The experience underlines the significant influence of occupant's behavior on the energy performance of buildings [13]. Indeed, occupants use energy to satisfy certain activities of everyday life such as heat, cooling, and light [14]. Several studies show that the influence of occupants on the energy performance of

¹ Generally, we use the term 'sector' to describe a type of building, such as an office or residential building, while a 'subsystem' refers to a group of appliances, such as lighting or the heating, ventilation and cooling (HVAC) system.

buildings can be reflected by their presence (internal heat gains, emissions of CO₂, etc.) and activities, as well as their interactions with inherent system controls to adjust the indoor environment. For example, they will heat, cool, or ventilate their environment to improve their thermal comfort. Similarly, they adjust lighting systems or blinds to optimize their visual comfort [14]. These interactions have a significant impact on the energy consumption of the building and affect both the indoor environment and the energy needs. In fact, the presence of occupants in a building has a significant impact on energy consumption [16].

Energy consumption can vary considerably between different households in residential buildings. According to Seryak and Kissock [17], occupant behavior in the residential sector can lead to variability in energy consumption of almost 100% for a given dwelling. Similar works have also demonstrated this variability [13, 18-20]. Many studies have identified occupant-related parameters that are responsible for this variation, such as the number of occupants and the presence profile [20, 21].

1.2 Uncertainties in the estimation of energy performance

Currently, the 'performance gap'² has received a lot of attention. Many studies show that actual energy consumption, especially for heating, can be up to three times that expected even for very efficient buildings. In a study of a residential building group in Germany, the difference between calculated and measured heating consumption was 300% [22]. The study by Cali et al. [23] found a large variation in energy consumption, ranging from 0 to over 280% in three different buildings in Germany.

In 2008, CarbonBuzz provides a platform to compare and track the energy consumption of projects from the design phase to the exploitation phase. The platform allows designers to compare the energy consumption predicted in the design phase with that measured. The results show that, on average, buildings consume between 150% and 250% more than the design values (CarbonBuzz).

The 'performance gap' can be caused by many factors that can be influenced by the design, construction and exploitation of buildings. Understanding the causes of the gap is essential to improve the system in its various phases from design to operation.

² In 1994, Norford et al. [25] described the phenomenon known as the 'performance gap' which expresses the difference between the energy performance estimated by the models and that measured in situ.

1.3 Importance of the zone's position and internal insulation in a multi-zone building

While most of the research has focused on the insulation of the external building envelope, such as external walls and roofs [24], there is a gap in the literature regarding the energy saving effects of thermal insulation of internal walls. In fact, internal wall insulation is an important key to reducing building energy consumption by reducing heat transfer between adjacent zones at different temperatures, especially for multi-zone buildings.

Innovations in heating systems allow occupants to control room temperature independently. However, this can also lead to significant heat transfer between adjacent zones. In the case of residential buildings, the transfer of heat between adjacent zones is usually not considered and leads to an over or underestimation of the heating/cooling demand of each zone. The heat flow between two adjacent zones can be called "stolen energy", which depends on several factors: (1) The direction of the transfer; (2) the change of the indoor temperature set point by the occupant [26].

Siggelsten [27] presented a study to develop a cost-efficient method for estimating the size of heat transfer between adjacent apartments in multi-zone buildings. He found that this type of heat loss could be as high as 9 %. The aim is to use these estimates to assign heating costs due to heat transfer when measuring the amount of heating energy provided to a zone. Liu et al [28] also found that heat transfer through the floor can increase heating by 20-30% when neighbors are not heated. Therefore, thermal insulation of the interior walls and floor is very important for residential buildings.

Xuan et al [29] have demonstrated that internal wall insulation is more efficient than floor insulation under difficult climatic conditions. It is suggested to insulate both the interior walls and the floor to achieve higher total heating energy savings. They confirmed that the potential heating energy savings with 20 mm insulation thickness on the interior walls and floor were 12.3% and 11.4% in Harbin and Beijing, respectively.

2. Literature review

2.1 Identification of uncertainties types

In many studies, large differences between actual and simulated consumptions have been observed, even when the thermal insulation of the envelope is considered [17]. These differences can be attributed to the uncertainties introduced by several components such as the

accuracy of the simulation software, the accuracy of the input parameters describing the building envelope, as well as the heating, ventilation and cooling system [2, 24].

Although many explanations have been given to understand these differences, it has been shown that the lack of consideration of occupant behavior is one of the major sources of uncertainties in dynamic thermal simulation [30]. Thus, it is necessary to consider the key role of occupant activity in simulation models to correctly predict the real building consumptions.

Occupant interactions [12, 31-35] that can influence the indoor environment are often modelled using deterministic data [36]. To consider the diversity of occupant behavior, new probabilistic approaches are being developed to reduce the performance gap. These approaches consider random variation, according to defined probability distributions [10, 37, 38].

Uncertainty analysis provides information on the reliability and influence of input parameters. Researchers affirm that the simulation result should always include information on the uncertainties of the input variables and the result. Indeed, Heiselberg et al. [39] states that evaluating the result of a thermal simulation based on deterministic variables, without information on the deviation or error of this result, can result a false conclusion.

2.2 Uncertainties of occupant behavior

In 1978, a study was carried out on a group of identical houses in Twin Rivers, USA. One of the main questions of the Twin Rivers programme was why energy consumption varied so much between identical houses. The authors concluded that 71% of the unexplained variation in energy use was due to occupant habits [40]. Ten years later, Schipper et al. [41] have found that about 45-55% of total energy consumption is influenced by occupant behavior in developed states.

In 2009, Juodis et al. [42] presented a comparison study on heating and domestic hot water consumption. The data of 2280 buildings are compared. The authors found that the largest difference in heating consumption is between older buildings (similar floor area). A ratio of four or more is observed between the maximum and minimum values.

Andersen [43] examined the distribution of heating consumption in 290 identical houses. They found that the consumption varied significantly from one house to another. The results showed that the consumption varies between 9.7 kWh/m² and 197 kWh/m², which is a ratio of

20 between the highest and lowest consumption. The most probable explanation for this diversity is the way in which the occupants live.

Clevenger [13] studied 11 factors related to occupant behavior. These factors are classified into two categories: presence (occupancy time, lighting time, equipment use time) and loads (Number of occupants, metabolic gains, equipment gains, temperature set point, ventilation rate). Three values are assigned for each factor (a low, medium and high value). A 'typical' behavior is defined by setting all factors to average values. The simulation results show that the impact of occupant behavior on the energy consumption of the building is significant. Indeed, the energy consumption is increased by more than 150% compared to a 'typical' occupant behavior.

Yan et al. [44] investigated the influence of occupant behavior uncertainties on the thermal performance of a naturally ventilated building. They used Markov chain and Monte Carlo methods to develop a behavioral algorithm to evaluate the impacts of occupant behavior. Also, Azar and Menassa [45] conducted a sensitivity analysis study of occupancy behavioral parameters in office buildings of different sizes and climate zones. A sensitivity index was calculated. As a result, the highest sensitivity index was observed when the setpoint temperature was varied.

Silva and Ghisi [46] analyzed uncertainties using a probabilistic approach. The EnergyPlus software was used to evaluate the energy consumption of a house located in Florianopolis, southern Brazil. The Latin hypercube sampling method was used to create samples. As a result, specific heat, material thickness, solar absorption, floor temperatures, physical parameters, occupancy schedules, equipment power densities and number of occupants were found to be the influential parameters in the analysis. As a result of this study, the uncertainty values obtained are 19.5% for the physical parameters and 36.5% for the occupant behavior parameters during the heating season. For the cooling season, these uncertainty values are 43.5% and 38.0% respectively.

To regulate the indoor environment, the occupant searches through actions to achieve thermal comfort such as operations on the temperature set point, windows, blinds, lighting etc. All these practices and reactions have a considerable impact on the energy performance of buildings. Zhou et al. [47] have modeled the occupant behavior in open-plan offices by using the random forest (R F) algorithm developed to simulate the effect of window openings. The

aim of this study was to determine the influencing window operating behavior. The occupant behavior related to window opening is studied through experimental measurements and surveys collected in three open-plan offices in Nanjing, Jiangsu Province, China. As a result, the indoor temperature, indoor humidity, the CO₂ concentration as well as the outdoor parameters and time of day are the key influencing parameters in window opening.

2.3 Uncertainty analysis: the Monte Carlo method

For several years, much attention has been given to the consideration of uncertainty in the analysis of building energy performance [48]. The development of uncertainty quantification methods is facilitating research to properly control the nature of uncertainty associated with building energy performance.

One of the main objectives of this paper is to have a model that allows to obtain as output distributions of the building energy consumptions (heating and cooling). Thus, rather than a single value obtained using a deterministic occupancy scenario, we chose to work with the Monte Carlo method. In fact, the Monte Carlo method is widely used to study the propagation of inputs uncertainties in many works such as [49-51]. However, in the literature there are two methods of uncertainty propagation: (i) the direct method [52] and (ii) the inverse method [53]. Indeed, in the direct method, the uncertainty propagation is based on the quantification of energy needs (outputs) from uncertain input variables. In opposite, the inverse uncertainty analysis allows the determination of unknown variables by using the existing energy consumption.

2.4 Dynamic thermal simulation

Nowadays, many simulation tools are available on the market such as Energy-Plus [54], Pleiades [55] and TRNSYS [56]. This software can simulate the energy performance of the building. In this study, Pleiades +COMFIE is the STD software used to validate the RC model. Pleiades+COMFIE was developed at the École des Mines de Paris energy centre where it continues to be enhanced. This software is distributed by the company Izuba énergies³. The accuracy of the results given by Pleiades+COMFIE has been tested on several occasions by comparing the results of the tool with measurements. In the work of Munaretto et al. [57], the convective and long-wave radiative heat transfer models are investigated in COMFIE, a dynamic energy simulation platform. More detailed internal heat transfer models

³ For more information : <https://www.izuba.fr/>

are developed by decoupling convective and long-wave radiative heat transfers and using time-dependent coefficients. Moreover, two detailed models (model 1 for the thermal network and internal long-wave radiation model, and model 2 for internal convection model) were implemented in a modal based dynamic BES software COMFIE. Furthermore, an empirical validation process on both simplified and detailed models is carried out. The results of the simulation platform were compared with on-site measurements on a passive house, located in Chambéry (France), considering different sources of uncertainty (measurements, input parameters and model accuracy). It appeared that the simulation platform performed satisfactorily over all the experimental scenarios.

Recht et al. [55] present an empirical validation process of the dynamic thermal simulation tool COMFIE, based on temperature measurements of the INCAS⁴ experimental platform located at Le Bourget du Lac, is presented. The most influential uncertain factors of the model were identified by Morris screening in order to make possible uncertainty propagation. This variability caused on the results was quantified and compared to the measurement uncertainty. In addition, a global sensitivity analysis via Sobol indices was carried out to evaluate the contribution of each factor on the global uncertainty. The results show a good fitting between the experimental measurements and the model and also with benchmarks such as EnergyPlus. Thus, the most influential factor of the study, the outdoor temperature, presents a relatively high uncertainty.

2.5 Purpose of the study

All the work done above, shows the importance of the position of a zone in a multi-zone building. Today, the problem of "stolen energy" between adjacent zones is evoked since the heating temperature varies significantly between households [58], resulting in variable costs between zones due to their positions. To highlight this difference, a model of presence is developed and coupled with the multi-zone model. Absences are generated randomly by considering different types of households for each zone. The choice of this approach allows to study the effect of the temperature variation of an empty zone (absent occupants) on the energy consumption of other zones. Furthermore, a multi-zone model is proposed, based on the mono-zone RC thermal model.

⁴ The INCAS platform is located at the Institut National de l'Énergie Solaire : <https://bit.ly/3sH1x1h>

The document is structured as follows: Section 3 presents the multi-zone RC model as well as its validation. In this study, we use a less complicated method, based on numerical simulation. This consists of using an RC model to model a building (geometry, wall composition, window and door openings, etc.) and simulate the heating consumption of the building. To examine without disturbance, the influence of the position of the zone and the importance of the interior insulation, we consider identical uses in all zones. Similarly, the external insulation and window and door openings are homogeneous between all zones. The differences in consumption between dwellings can only be due to their position (section 4). Section 5 present details of the uncertainty analyses and the effect of long absences on energy consumption. Thus, an occupancy pattern is generated in each zone of the building to consider the long occupant absences related to holidays based on the data obtained from the National Institute of Statistics and Economic Studies INSEE data.

3. Modeling and validation

3.1. Analogical modeling of heat transfers

Thermal modelling is used to predict the energy needs of the building. Methods for calculating heat transfer in buildings can be divided into two categories:

- **Static models:** These models predict the energy needs of a building in permanent regime. In fact, the temperature inside the building is equal to the set temperature at each time t , so the loads are constant over time. An example is the method that uses the concept of Degree Day (DD) to evaluate the energy needs of a building [59]. On the other hand, static models do not consider the thermal behaviour of the building under transient conditions. According to Zayane [60], "these models are not able to account for heating control, although the two components (building and heating and cooling system) necessarily interact".

The degree-day method provides an estimate of the heating and cooling needs of a building. This method is based on a permanent analysis of the heat balance, including heat transfer by conduction, convection and radiation. However, the heat transfer by conduction and radiation is mostly transient. Therefore, the degree-day method is limited since the calculation of heat transfer in a building must consider transient effects.

- **Dynamic models:** These models use the methods for calculation of transient heat transfer in buildings. Indeed, they consider the evolution of different thermal loads to simulate the thermal behavior of the building. Thus, simplified models based on electrical equivalences are widely used. Indeed, they consist in modelling the thermal dynamics of the building through an equivalent electrical circuit whose number of resistors and capacities can be easily modified to fit any specific building.

One of our objectives is to propose a model of the thermal behavior of the building that will be coupled with a model of the occupant's presence. Given the diversity of existing models, the most interesting candidate is the family of simplified models. We have chosen to work with RC (resistance-capacity) models. These models are a good compromise between simplicity and reasonable accuracy. In addition, they consider different specific characteristics of buildings, such as wall materials, types of windows/doors, internal thermal mass, etc. Many authors have used RC models to represent heat transfer [61-63].

3.2. Model

In this section, the R3C2 model is used to model a multi-zone building. Figure 1 and 2 shows a zone in a multi-zone building that is composed of an exterior wall, window and door and interior spaces. The main heat transfer mechanisms are: (1) thermal conduction through external and internal walls, windows, doors and ceiling; (2) thermal convection with external air and with internal air between zones; (3) solar radiation through window and external wall; (4) heat gain from occupants and equipment and (5) air infiltration.

The following assumptions are made: (a) the temperature gradient within the volume delimiting the zone is negligible since the air inside the zone is well mixed, so that we have one uniform temperature in the zone. (b) Each zone is coupled to the other building elements by coupling terms (convective exchange coefficient between the wall separating two zones). (c) Solar gains are considered here as having a direct influence on the zone (through wall heating). (d) Air flow between zones is not considered.

The R3C2 model with three resistors and two capacitors (R_i , R_o , R_f , C_s and C_{res}) which are detailed in Table 1 is used to model heat transfer through a compact surface separating the indoor and outdoor environments. As the window has a very low thermal capacity, it is

modelled as a simple resistor R_f . A solar flux Q_s is injected at the node representing the internal surface of the T_s structure. The total power Q_{res} (heating power and internal gain) is injected at the node representing the internal temperature T_{int} . An additional resistor is included in R3C2 to model the heat transfer between the building zones by conduction and convection of the internal air of the zone. The structure of the full-scale model is shown in Figure 1.

S_{room} denotes the surface of the room, $S_{ceiling}$ is the ceiling surface, S_{floor} is the floor surface, S_{wallV} is the surface of the walls, h_{iwallV} , h_{ifloor} and h_{iroof} are respectively the coefficients of internal heat exchange for vertical walls, floor and roof, C_{air} is the heat capacity of air, ρ_{air} is the density of air and V_{room} is the volume of the room.

The modelling is considered by decomposing the building as follows: (1) Environment: a set of meteorological conditions constituting the boundary conditions. (2) Zones: volumes where all properties and temperature states are homogeneous. (3) Walls: The walls of the envelope such as walls, ceilings, partitions and windows. Heat conduction in these elements is unidirectional. (4) Indoor air equipment: all systems that have a thermal influence by convection or radiation exchange (heating, air conditioning, etc.).

The ordinary differential equation describing the temperature gradient of each zone of building is written as follows:

$$\left\{ \begin{array}{l} \frac{dT_{int-Zone(i)}}{dt} = \frac{1}{C_{res-Zone(i)}} \times \left[- \left(\frac{1}{R_{i-Zone(i)}} + \frac{1}{R_{f-Zone(i)}} + \sum_{j=1}^n \frac{1}{R_{Zone(i)-Zone(j)}} \right) \times T_{int-Zone(i)} + \frac{1}{R_{i-Zone(i)}} \times T_{s-Zone(i)} \right. \\ \left. + \frac{1}{R_{f-Zone(i)}} \times T_{ext} + Q_{res-Zone(i)} + \sum_{j=1}^n \frac{1}{R_{Zone(i)-Zone(j)}} \times T_{Zone(j)} \right] \\ \frac{dT_{s-Zone(i)}}{dt} = \frac{1}{C_{s-Zone(i)}} \times \left[\frac{1}{R_{i-Zone(i)}} \times T_{int-Zone(i)} - \left(\frac{1}{R_{i-Zone(i)}} + \frac{1}{R_{o-Zone(i)}} \right) \times T_{s-Zone(i)} + \frac{1}{R_{o-Zone(i)}} \times T_{ext} + Q_{s-Zone(i)} \right] \end{array} \right.$$

Where j is the number of zones in contact with the zone i .

The indoor air equipment (air conditioner, radiator) is modeled by a PI controller (Proportional-Integral) characterized by two coefficients K : the controller gain and the controller integration time τ . The power exchanged between the heating and the zone representing by a convective coupling term Q_{ch} . It can be determined through a differential equation per zone (2) [64].

$$Q_{ch} = K \times ((T_c - T_{int}) + \frac{1}{\tau} \times \int_0^t (T_c - T_{int})) \quad (2)$$

3.3. Model validation

To validate the multi-zone model, a comparison with the Pleiades software was undertaken. For a brief demonstration, a comparison case is presented here which consists of a multi-zone building, located in the city of Montluçon in France. The building is composed of three floors. Each floor contains three zones of 20 m² each. In each zone there is a window (1.5 x 1.5 m) in the north wall and a door (0.83 x 2.04) in the south wall (Figure 2).

The thermal properties of ceilings, roofs, partitions, walls (north, east, west and south), windows and doors are given in table 2. The outer walls are composed of concrete layer and insulated from the outside.

To validate this model, the results are compared to those obtained by the dynamic thermal simulation software Pleiades using the same input data. The comparison is undertaken, with a time step of one hour, for indoor air temperature. The results are given in Figure 2. The relative difference in indoor temperature ΔT_{indoor} is calculated by equation (3). This factor verifies the ability of the RC model to predict the indoor temperature of the building over the forecast period.

$$\Delta_{Indoor} = \frac{\int_0^t T dt - \int_0^t T_{int} dt}{\int_0^t T dt} \quad (3)$$

where T and T_{int} are respectively the reference and RC indoor temperatures.

Figure 2 shows that the R3C2 model provides very good predictions compared to the reference model (Pleiades). Over the time, the maximum difference between the two models is less than 1.5 °C for all the zones of the building as shown in Figure 2. This difference can be explained by the modelling approaches in considering thermal inertia by the R3C2 thermal model and the Pleiades software.

The model validation is performed by calculating the error between the R3C2 model and the reference model. This error is calculated according to the formula (3) for indoor temperature.

The results are presented by the histogram in Figure 2 representing the error distribution over one year of simulation.

4. Deterministic part: highlighting loss of energy and impact of interior insulation

To evaluate deeply the importance of thermal insulation of interior walls between zones, a parametric analysis was carried out by considering six different configurations predicated step by step to each zone constituting the building. The case studies, given in Table 3, were studied to allow the impact of occupant presence/absence on total energy consumption. A standard scenario is considered. It is based on an indoor temperature set at 20°C when the zone is occupied and reduced to 16°C when the zone is unoccupied.

For example, in case one, when zone 01 is empty, the other zones are occupied. Then, the same for each study case. Keeping one zone empty for each study allows determining the worst case that maintains a maximum energy consumption of the whole building. In this section, a residential building with nine zones and twelve thermal interaction areas (six vertical thermal interactions and six horizontal thermal interactions) for the whole building are presented in Figure 2. The following assumptions are made for all case studies: The zones of thermal interactions are not insulated; all the areas of the buildings are insulated from the exterior; the heat gain due to occupation is not considered. When a zone considered not occupied, all sources of internal gain are off.

Each zone is considered as an apartment and each zone has a thermal interaction with adjacent zones. The corner zones (01, 03, 21 and 23) of each floor have two thermal interaction zones while the central zones (02, 11, 13 and 22) of each floor have three interaction zones; only zone 12 has four thermal interaction zones.

Table 4 and Table 5 shows respectively heating and cooling energy needs for a cold week in winter and a hot week in summer for each studied case. The simulation results are presented in two steps: (1) without interior insulation and (2) with interior insulation. It is shown that case 4 is less energy-efficient than the other cases during the winter and summer period. Proportionally, the biggest difference between these cases is observed when the zone 12 is empty: the difference in heating loads reaches 116 kWh/week, 7.33 %, while the difference in cooling load reaches 55 kWh/week, 7 %. Tables 4 and 5 also reveal the importance of the location of the zones in the building. The change from one case of study to another makes it

possible to observe large differences in heating and cooling energy needs. Moreover, the case study 4, which represents the highest energy consumption, is the one which represents the highest number of thermal interactions. These results show that, the number of thermal interactions between zones has a very important impact on energy consumption. Furthermore, the location of an apartment in a building can have significant effect on its needs for heat. For example, the location on top floor means greater proportion of outer walls and therefore a greater demand for heat in winter.

To highlight the importance of the internal insulation between building zones, it has been decided to insulate all the thermal interactions for the worst configuration (case 4). Glass wool insulation was used on the four thermal interactions of the zone 12. The insulation is considered to range between 0 cm and 20 cm.

Figure 3 shows the importance of the level of interior insulation. It is noted that the energy consumption of zones 01, 03, 21 and 23 is stable since there are no thermal interactions with zone 12. However, the energy consumption is decreased progressively for other zones (02, 11, 13 and 22) in contact with zone 12 due to thermal interaction. The energy consumption for these zones decreases with the reduction of insulation thickness. The difference between these four zones is summarized at the level of the slope of decrease in the energy consumption in each zone when the thickness of the insulator is varied. However, the decrease in consumption is slower for zones 11 and 13 compared to zones 02 and 22. This difference is due to the addition air gap in the vertical partitions. In fact, this air gap represents an additional thermal resistance that gives the vertical partitions a better insulation compared to the floor or the ceiling where the air gap is not a part of composition.

5. Impact of occupant behavior

5.1 The effect of long absences on energy consumption

Long occupant absences related to holidays, sick leaves or business travels have a significant effect on the overall annual presence. However, they are generally neglected in deterministic scenarios. Based on the measures available, Page et al. [38] tried to identify periods of long absence from the workplace and integrate them into their model. They calculated the probability that the occupant would begin a period of long absence as well as the distribution of the durations of these periods. Their algorithm tests at each time step the possibility that an occupant leaves for a long period and, in case of departure, associates to him a fixed duration.

The objective of this section is to generate stochastic occupancy patterns in each zone of the building that can then be used by the R3C2 thermal model to estimate the energy consumption. The basic idea of the model is that the occupancy of each zone of the building is a direct result of the absence and presences processes of a household that occur in each zone of the building. The method of random sampling is selected to simulate the process of absence and presence of occupants in the building. The implementation of the model is carried out determining the typology of the building and occupant parameters (household type, number of households absent for a year, etc.). The model is implemented as a Matlab routine. Family type and size, presence and absence of the occupant are simulated randomly. During the absence of the occupant, a constant temperature of 16 ° C was applied in winter and 28 ° C in summer. Otherwise (presence), a variation of the weekly temperature as it is presented in Table 3 is applied.

Figure 4 shows the flowchart of the algorithm. Each building contains a well-defined number of zones per floor. (1) Each zone of the building is occupied by a type of household in a random manner. (2) Defining the probability of being absent during each season of the year (winter and summer) for each household type. (3) decide the number of times that each family will go out for vacation (absent state). The algorithm considers the probability of leaving on vacation. If this is the case, a vacation period begins. The duration of absence is determined according to the type of household and the summer or winter season. (4) Once the number of absences is defined for each household, and for each simulation sampling, the weekly energy consumption is calculated.

5.2 Data

Regarding the input data, each type of household created is therefore associated to a building zone and attached, afterward, to a category of presence schedules. The category of schedules can be predefined or randomly chosen at different scales. It is then applied for all the building or for each zone considering the number of occupants. For example, we supposed that the occupants of the zone “i” are all present during the year, while those of zone “j” have different schedules. Therefore, it would be very useful to have more complete data to define with precision a range of variation of these absences and presences parameters.

Performing an experimental platform to collect database information regarding the presence and absence of occupant in residential building is excessively expensive. It

is also difficult to carry out regular measurements, especially when the occupant is not cooperating or is uninterested in the survey. The alternative proposed in this section is the use of statistical data on the departure rates of different types of households on a national basis. The construction of the model is based on data from several holiday surveys completed by INSEE in 1994, 1999 and 2004 [65]. According to the results of the 2004 Holiday Survey, the probability of going on holiday and duration of stays according to the type of household is distributed as shown in Table 6.

5.3 Results of simulation

In this study, the year is divided into two seasons; the heating season which begins from week 1 until week 24 and week 39 to week 52, and the cooling season from week 25 to week 38, as shown in Figure 5. The occupancy profiles of each zone in the building as well as the type of household are randomly defined in each simulation according to the data in Table 6. To be precise, the number of absences for each type of household is given in weeks. That is, in the summer, the number of weeks of absence varies between 3 and 4 weeks, while in the winter it is between 2 and 3 weeks. It is not only the number of weeks of absence that is randomly chosen, but also the number of times per year. These numbers vary between 0 (Min) and 2 times (Max). In other words, Figure 5 shows the distribution of the number of absences according to the type of household and the period for a single simulation. The household in each zone goes on holiday twice a year, once in the summer and once in the winter. It should be noted that in some cases, we can find that the period of vacancy starts at the end of winter and ends in summer and vice versa, this is the case for zone 02, 21 and 23. Furthermore, in the case of zone 11, the winter and summer vacancy period is combined to form a very long absence period of 8 weeks (4 weeks in summer and 4 weeks in winter). In summary, this algorithm can generate all combinations of absence in a multi-zone building.

The objective is to evaluate the impact of short and long absences for residential energy consumption. The simulation for each apartment runs 1000 times of the year consecutively, with different random samples for each simulation. Figure 6 summarizes the results of 1000 simulations only for apartments 01, 02 and 03. There are 3 profiles, as explained in the previous paragraph:

- 0 absence throughout the year:
- 1 time: during winter or summer: this profile includes all the simulations where the households for each zone will be absent one time a year (during the summer or winter).
- 2 times: once during winter and once during summer: it is presented by the simulations where the household of each zone will be absent twice a year (one during the summer and the other during the winter).

For clarity, Figure 7 presents the results of 1000 simulations in the form of a whisker box. For each week, the model can predict the percentage of going on holiday for such a household according to the number of total absences per year. For example, for the household in zone 01, the probability of going on holiday once is equal to 0.241 (going once), 0.618 (going twice) and 0.141 for the case of zero absences. In addition, this model allows us to determine the average number of absences in the building, during each week, through the results presented in the form of box plots.

Figure 8 shows part of the temperature profile. It is 16°C in winter and 28°C in summer, while the household is absent. It should be noted that the temperature profile assumption is respected in each zone and during each simulation. Figure 8 shows the evolution of the indoor temperature in zone 01 during a period of household presence and absence (between weeks 4 and 10). The indoor temperature reaches the target temperature. Consequently, these results show the ability of the proposed model to reproduce the occupant's profile with respect to indoor temperature by respecting the profile presented in Table 3.

5.4 Energy consequences

Figure 9 represents the yearly distribution of building heating and cooling loads for each zone, according to the number of absences per year. To evaluate the impact of the long absence on the energy consumptions, the results are compared with a standard case where the entire zones are occupied during the year. To compare the different results with each other, 1000 Monte Carlo simulations have been performed with time steps of 60 minutes to evaluate the distribution of energy consumptions.

The consumption resulting from the standard case is not always superior to consumption from other cases (absent two times, absent one time or mixed). Therefore, the standard case does not always represent an over-evaluation of the energy consumptions, since it represents a

determinist scenario used by default in the software tools. The integration of periods of long absences inevitably reduces the presence in the zone and therefore the consumptions for heating and cooling. However, it may increase or decrease consumption in adjacent zones depending on the location of the zone in the building as well as on the period of absence of the households in each zone.

It is noted that for different absence configurations (standard, two times, one time and mixed), the central zone in each floor (zones 02, 12 and 22) have the lowest heating consumption as shown in Figure 9. Contrary, the corner zones in each floor have the highest heating consumption.

6. Conclusion

This paper evaluates the thermal interaction between zones in the same building regarding the occupant behavior. An approach for occupancy simulation based on the random variation was proposed. Occupancy is represented as a direct result of the presence or absence of occupants in their zones. By using the Monte Carlo method to simulate presence and absence, the proposed model can generate the number of absences per year and per season for each household type. Various holiday surveys conducted by INSEE are used to input the model.

For the case study of multi-zone building, the model can produce the realist occupancy variation in the building for each zone. Especially, it can produce a different number of absences between apartments, which can later determine the effect of this absence in energy needs between zones. Running simulations with a model capable of generating short and long holiday periods has a significant impact on energy consumption compared to simulations with standard occupancy scenarios.

Regarding insulation between zones, the results show the importance of the level of interior insulation for the central zone. The energy consumption for this later situated on the middle floor is always low comparing to other zones in other floors. Furthermore, the energy consumption for zones in interaction with the central one decrease progressively with the reduction of insulation thickness but it stays stable for zones without interaction with the central one.

In the future, an experimental validation should be carried out to validate this occupation model. In addition, more events such as sick leaves, maternity leaves or

paternity leaves should be considered in each zone. The capacity of the model in other types of buildings, such as office buildings, should be tested and calibrated.

Acknowledgements

The Allier General Council – France, is grateful to have provided financial support for this study.

References

- [1]: Al-Sanea, S. A., Zedan, M. F., & Al-Hussain, S. N. (2012). Effect of masonry material and surface absorptivity on critical thermal mass in insulated building walls. *Applied Energy*, 102, 1063–1070. <https://doi.org/10.1016/j.apenergy.2012.06.016>.
- [2]: Aïssani, A., Chateaufneuf, A., Fontaine, J. P., & Audebert, P. (2016). Quantification of workmanship insulation defects and their impact on the thermal performance of building facades. *Applied Energy*, 165, 272–284. <https://doi.org/10.1016/j.apenergy.2015.12.040>.
- [3]: Martin, K., Escudero, C., Erkoreka, A., Flores, I., & Sala, J. M. (2012). Equivalent wall method for dynamic characterisation of thermal bridges. *Energy and Buildings*, 55, 704–714. <https://doi.org/10.1016/j.enbuild.2012.08.024>.
- [4]: Roetzel, A., Tsangrassoulis, A., Dietrich, U., & Busching, S. (2010). On the influence of building design, occupants and heat waves on comfort and greenhouse gas emissions in naturally ventilated offices. A study based on the EN 15251 adaptive thermal comfort model in Athens, Greece. *Building Simulation*, 3(2), 87–103. <https://doi.org/10.1007/s12273-010-0002-7>.
- [5]: Spandagos, C., & Ng, T. L. (2017). Equivalent full-load hours for assessing climate change impact on building cooling and heating energy consumption in large Asian cities. *Applied Energy*, 189, 352–368. <https://doi.org/10.1016/j.apenergy.2016.12.039>.
- [6]: Steg, L., Perlaviciute, G., & van der Werff, E. (2015). Understanding the human dimensions of a sustainable energy transition. *Frontiers in Psychology*, 6. <https://doi.org/10.3389/fpsyg.2015.00805>.
- [7]: Dixit, M. K., Fernández-Solís, J. L., Lavy, S., & Culp, C. H. (2010). Identification of parameters for embodied energy measurement: A literature review. *Energy and Buildings*, 42, 1238–1247. <https://doi.org/10.1016/j.enbuild.2010.02.016>.
- [8]: Yan, D., O'Brien, W., Hong, T., Feng, X., Burak Gunay, H., Tahmasebi, F., & Mahdavi, A. (2015). Occupant behavior modeling for building performance simulation: Current state and future challenges. *Energy and Buildings*, 107, 264–278. <https://doi.org/10.1016/j.enbuild.2015.08.032>.
- [9]: Enerdata et ADEME. (2018). *Climat, Air et Énergie-Chiffres Clés*. https://www.ademe.fr/sites/default/files/assets/documents/2018-climat-air-energie_chiffres-cles-010354.pdf.
- [10]: Wang, C., Wu, Y., Shi, X., Li, Y., Zhu, S., Jin, X., & Zhou, X. (2020). Dynamic occupant density models of commercial buildings for urban energy simulation. *Building and Environment*, 169, 106549. <https://doi.org/10.1016/j.buildenv.2019.106549>.
- [11]: WBCSD. (2009). *The Energy Efficiency in Buildings project*.
- [12]: Balvedi, B. F., Ghisi, E., & Lamberts, R. (2018). A review of occupant behaviour in residential buildings. *Energy and Buildings*, 174, 495–505. <https://doi-org.ezproxy.uca.fr/10.1016/j.enbuild.2018.06.049>.
- [13]: Clevenger, C. M., & Haymaker, J. (2006, June). The impact of the building occupant on energy modeling simulations. In Joint International Conference on Computing and Decision Making in Civil and Building Engineering, Montreal, Canada (pp. 1–10). <https://itc.scix.net/pdfs/w78-2006-tf565.pdf>.
- [14]: Kashif, A., Ploix, S., Dugdale, J., & Le, X. H. B. (2013). Simulating the dynamics of occupant behaviour for power management in residential buildings. *Energy and buildings*, 56, 85–93. <https://doi.org/10.1016/j.enbuild.2012.09.042>.
- [15]: Page, J., Robinson, D., Morel, N., & Scartezzini, J. L. (2008). A generalised stochastic model for the simulation of occupant presence. *Energy and buildings*, 40(2), 83–98. <https://doi.org/10.1016/j.enbuild.2007.01.018>.
- [16]: Robinson, D. Some trends and research needs in energy and comfort prediction. Windsor Conference 2006.
- [17]: Seryak, J., & Kissock, K. (2003). OCCUPANCY AND BEHAVIORAL AFFECTS ON RESIDENTIAL ENERGY USE. *Proceedings of the Solar Conference*, 21–26. <https://www.sbse.org/sites/sbse/files/attachments/scholarships/Seryak1.pdf>.

- [18] : Emery, A. F., & Kippenhan, C. J. (2006). A long term study of residential home heating consumption and the effect of occupant behavior on homes in the Pacific Northwest constructed according to improved thermal standards. *Energy*, 31(5), 677-693.
<https://doi.org/10.1016/j.energy.2005.04.006>.
- [19] : Masoso, O. T., & Grobler, L. J. (2010). The dark side of occupants' behaviour on building energy use. *Energy and buildings*, 42(2), 173-177.
<https://doi.org/10.1016/j.enbuild.2009.08.009>.
- [20] : Yun, G. Y., & Steemers, K. (2011). Behavioural, physical and socio-economic factors in household cooling energy consumption. *Applied Energy*, 88(6), 2191-2200.
<https://doi.org/10.1016/j.apenergy.2011.01.010>.
- [21] : Guerin, D. A., Yust, B. L., & Coopet, J. G. (2000). Occupant predictors of household energy behavior and consumption change as found in energy studies since 1975. *Family and Consumer Sciences Research Journal*, 29(1), 48-80.
- [22] : Erhorn, H. (2007). *Bedarf-Verbrauch: Ein Reizthema ohne Ende oder die Chance für sachliche Energieberatung?*
- [23] : Cali, D., Osterhage, T., Streblov, R., & Müller, D. (2016). Energy performance gap in refurbished German dwellings: Lesson learned from a field test. *Energy and Buildings*, 127, 1146–1158. <https://doi.org/10.1016/j.enbuild.2016.05.020>.
- [24] : Aissani, A., Chateaneuf, A., Fontaine, J. P., & Audebert, P. (2014). Cost model for optimum thicknesses of insulated walls considering indirect impacts and uncertainties. *Energy and buildings*, 84, 21-32.
<https://doi.org/10.1016/j.enbuild.2014.07.090>.
- [25] : Norford, L. K., Socolow, R. H., Hsieh, E. S., & Spadaro, G. V. (1994). Two-to-one discrepancy between measured and predicted performance of a 'low-energy' office building: insights from a reconciliation based on the DOE-2 model. *Energy and buildings*, 21(2), 121-131.
[https://doi.org/10.1016/0378-7788\(94\)90005-1](https://doi.org/10.1016/0378-7788(94)90005-1).
- [26] : Gafsi, A., & Lefebvre, G. (2003). Stolen heating or cooling energy evaluation in collective buildings using model inversion techniques. *Energy and buildings*, 35(3), 293-303.
[https://doi.org/10.1016/S0378-7788\(02\)00093-2](https://doi.org/10.1016/S0378-7788(02)00093-2).
- [27] : Siggelsten, S. (2014). Reallocation of heating costs due to heat transfer between adjacent apartments. *Energy and Buildings*, 75, 256-263.
<https://doi.org/10.1016/j.enbuild.2014.02.022>.
- [28] : Liu, L., Fu, L., Jiang, Y., & Guo, S. (2011). Major issues and solutions in the heat-metering reform in China. *Renewable and Sustainable Energy Reviews*, 15(1), 673-680.
<https://doi.org/10.1016/j.rser.2010.08.009>.
- [29] : Cao, X., Liu, J., Cao, X., Li, Q., Hu, E., & Fan, F. (2015). Study of the thermal insulation properties of the glass fiber board used for interior building envelope. *Energy and Buildings*, 107, 49-58. <https://doi.org/10.1016/j.enbuild.2015.08.007>.
- [30] : O'Brien, W., & Gunay, H. B. (2014). The contextual factors contributing to occupants' adaptive comfort behaviors in offices - A review and proposed modeling framework. In *Building and Environment* (Vol. 77, pp. 77–87). Elsevier Ltd. <https://doi.org/10.1016/j.buildenv.2014.03.024>.
- [31] : Daum, D., Haldi, F., & Morel, N. (2011). A personalized measure of thermal comfort for building controls. *Building and Environment*, 46(1), 3–11.
<https://doi.org/10.1016/j.buildenv.2010.06.011>.
- [32] : Correia da Silva, P., Leal, V., & Andersen, M. (2013). Occupants interaction with electric lighting and shading systems in real single-occupied offices: Results from a monitoring campaign. *Building and Environment*, 64, 152–168. <https://doi.org/10.1016/j.buildenv.2013.03.015>.
- [33] : Tijani, K., Kashif, A., Ploix, S., Haas, B., & Dugdale, J. (2015). Comparison between purely statistical and multi-agent based approaches for occupant behaviour modeling in buildings. arXiv preprint arXiv:1510.02225.
- [34] : Haldi, F., & Robinson, D. (2009). Interactions with window openings by office occupants. *Building and Environment*, 44, 2378–2395. <https://doi.org/10.1016/j.buildenv.2009.03.025>.
- [35] : Andersen, R., Fabi, V., Toftum, J., Corgnati, S. P., & Olesen, B. W. (2013). Window opening behaviour modelled from measurements in Danish dwellings. *Building and Environment*, 69, 101–113. <https://doi.org/10.1016/j.buildenv.2013.07.005>.

- [36] : CSTB. (2012). *ANNEXE Méthode de calcul Th-BCE*.
- [37] : Vorger, E. (2014). *Study of the influence of occupant behaviour on the energy performance of buildings*. École nationale supérieure des mines de Paris.
- [38] : Page, J., Robinson, D., Morel, N., & Scartezzini, J.-L. (2008). A generalised stochastic model for the simulation of occupant presence. *Energy and Buildings*, 40, 83–98. <https://doi.org/10.1016/j.enbuild.2007.01.018>.
- [39] : Heiselberg, P., Brohus, H., Hesselholt, A., Rasmussen, H., Seinre, E., & Thomas, S. (2009). Application of sensitivity analysis in design of sustainable buildings. *Renewable Energy*, 34(9), 2030–2036. <https://doi.org/10.1016/j.renene.2009.02.016>.
- [40] : Socolow, R. H. (1978). The twin rivers program on energy conservation in housing: Highlights and conclusions. *Energy and buildings*, 1(3), 207-242. [https://doi.org/10.1016/0378-7788\(78\)90003-8](https://doi.org/10.1016/0378-7788(78)90003-8).
- [41] : Schipper, L., Bartlett, S., Hawk, D., & Vine, E. (1989). Linking life-styles and energy use: a matter of time?. *Annual review of energy*, 14(1), 273-320. <https://www.annualreviews.org/doi/pdf/10.1146/annurev.eg.14.110189.001421>.
- [42] : Juodis, E., Jaraminiene, E., & Dudkiewicz, E. (2009). Inherent variability of heat consumption in residential buildings. *Energy and Buildings*, 41, 1188–1194. <https://doi.org/10.1016/j.enbuild.2009.06.007>.
- [43] : Andersen, R. K. (2012). The influence of occupants' behaviour on energy consumption investigated in 290 identical dwellings and in 35 apartments. *Proceedings of Healthy Buildings 2012*, Brisbane, Australia.
- [44] : Yun, G. Y., Tuohy, P., & Steemers, K. (2009). Thermal performance of a naturally ventilated building using a combined algorithm of probabilistic occupant behaviour and deterministic heat and mass balance models. *Energy and Buildings*, 41(5), 489–499. <https://doi.org/10.1016/j.enbuild.2008.11.013>.
- [45] : Azar, E., & Menassa, C. C. (2012). A comprehensive analysis of the impact of occupancy parameters in energy simulation of office buildings. *Energy and Buildings*, 55, 841–853. <https://doi.org/10.1016/j.enbuild.2012.10.002>.
- [46] : Silva, A. S., & Ghisi, E. (2014). Uncertainty analysis of user behaviour and physical parameters in residential building performance simulation. *Energy and Buildings*, 76, 381–391. <https://doi.org/10.1016/j.enbuild.2014.03.001>.
- [47] : Zhou, X., Ren, J., An, J., Yan, D., Shi, X., & Jin, X. (2021). Predicting open-plan office window operating behavior using the random forest algorithm. *Journal of Building Engineering*, 42, 102514. <https://doi.org/10.1016/j.jobe.2021.102514>.
- [48] : Heo, Y., Graziano, D. J., Guzowski, L., & Muehleisen, R. T. (2015). Evaluation of calibration efficacy under different levels of uncertainty. *Journal of Building Performance Simulation*, 8(3), 135–144. <https://doi.org/10.1080/19401493.2014.896947>.
- [49] Breesch, H., & Janssens, A. (2010). Performance evaluation of passive cooling in office buildings based on uncertainty and sensitivity analysis. *Solar energy*, 84(8), 1453-1467. <https://doi.org/10.1016/j.solener.2010.05.008>.
- [50] Burhenne, S., Jacob, D., & Henze, G. P. (2010). Uncertainty analysis in building simulation with Monte Carlo techniques. *Proceedings of SIMBUILD*, 4(1), 419-426.
- [51] De Wilde, P., & Tian, W. (2010). Predicting the performance of an office under climate change: A study of metrics, sensitivity and zonal resolution. *Energy and Buildings*, 42(10), 1674-1684. <https://doi.org/10.1016/j.enbuild.2010.04.011>.
- [52] : Hopfe, C. J., & Hensen, J. L. M. (2011). Uncertainty analysis in building performance simulation for design support. *Energy and Buildings*, 43, 2798–2805. <https://doi.org/10.1016/j.enbuild.2011.06.034>.
- [53] : Braun, M. R., Altan, H., & Beck, S. B. M. (2014). *Using regression analysis to predict the future energy consumption of a supermarket in the UK*. <https://doi.org/10.1016/j.apenergy.2014.05.062>.
- [54] : Crawley, D. B., Hand, J. W., Kummert, M., & Griffith, B. T. (2008). Contrasting the capabilities of building energy performance simulation programs. *Building and environment*, 43(4), 661-673. <https://doi.org/10.1016/j.buildenv.2006.10.027>.

- [55] : Recht, T., Munaretto, F., Schalbart, P., & Peuportier, B. (2014). Analyse de la fiabilité de COMFIE par comparaison à des mesures. Application à un bâtiment passif. Proceedings IBPSA France, 8.
http://ibpsa.fr/jdownloads/Conferences_et_Congres/IBPSA_France/2014_conferenceIBPSA/Articles/recht-1144.pdf.
- [56] : Bonte, M., Thellier, F., & Lartigue, B. (2014). Impact of occupant's actions on energy building performance and thermal sensation. *Energy and Buildings*, 76, 219-227.
<https://doi.org/10.1016/j.enbuild.2014.02.068>.
- [57] : Munaretto, F., Recht, T., Schalbart, P., & Peuportier, B. (2018). Empirical validation of different internal superficial heat transfer models on a full-scale passive house. *Journal of Building Performance Simulation*, 11(3), 261-282.
<https://www.tandfonline.com/doi/abs/10.1080/19401493.2017.1331376>.
- [58] : Haldi, F. (2010). Towards a unified model of occupants' behaviour and comfort for building energy simulation (No. THESIS). EPFL.
- [59] : Sha, H., Xu, P., Hu, C., Li, Z., Chen, Y., & Chen, Z. (2019). A simplified HVAC energy prediction method based on degree-day. *Sustainable Cities and Society*, 51.
<https://doi.org/10.1016/j.scs.2019.101698>.
- [60] : Zayane, C. (2011). *Identification of a building thermal behaviour model from its load profile*. École Nationale Supérieure des Mines de Paris.
<https://pastel.archives-ouvertes.fr/pastel-00590810>.
- [61] : Baker, N. (2002). A Simplified Thermal Resistance Network Model for Building Thermal Simulation, Sim2002. *Proceedings of ESim, Montreal, Canada*.
https://www.academia.edu/16769880/A_Simplified_Thermal_Resistance_Network_Model_for_Building_Thermal_Simulation_Sim2002.
- [62] : Achterbosch, G. G. J., De Jong, P. P. G., Krist-Spit, C. E., Van Der Meulen, S. F., & Verberne, J. (1985). The development of a convenient thermal dynamic building model. *Energy and Buildings*, 8(3), 183-196. [https://doi.org/10.1016/0378-7788\(85\)90003-9](https://doi.org/10.1016/0378-7788(85)90003-9).
- [63] : Kramer, R., Van Schijndel, J., & Schellen, H. (2012). Simplified thermal and hygric building models: A literature review. *Frontiers of Architectural Research*, 1, 318–325.
<https://doi.org/10.1016/j.foar.2012.09.001>.
- [64] : J.M.Retif, «Automatique régulation». INSA Lyon.2008.
- [65] : <https://www.insee.fr/fr/statistiques?taille=100&debut=100&theme=9>

List of Figures

Fig. 1 Schematic figure of the RC model

Fig. 2 Response of the model: black line (Matlab: R3C2), purple line (Pleiades),
Distribution of indoor temperature error

Fig. 3 Indoor insulation of zone 12

Fig. 4 The workflow of algorithm

Fig. 5 Example for vacancy period for each zone (for one simulation)

Fig. 6 Number of absences per year for 1000 simulations for apartments 01, 02 and 03

Fig. 7 Number of absences over a year for all zones: two times per year

Fig. 8 Evolution of the internal temperature (blue) and the set point temperature (red)
for zone 01

Fig. 9 Yearly space heating-cooling thermal load (KWh/m² of heated and cooled area)
per zone and according to the number of absences per year

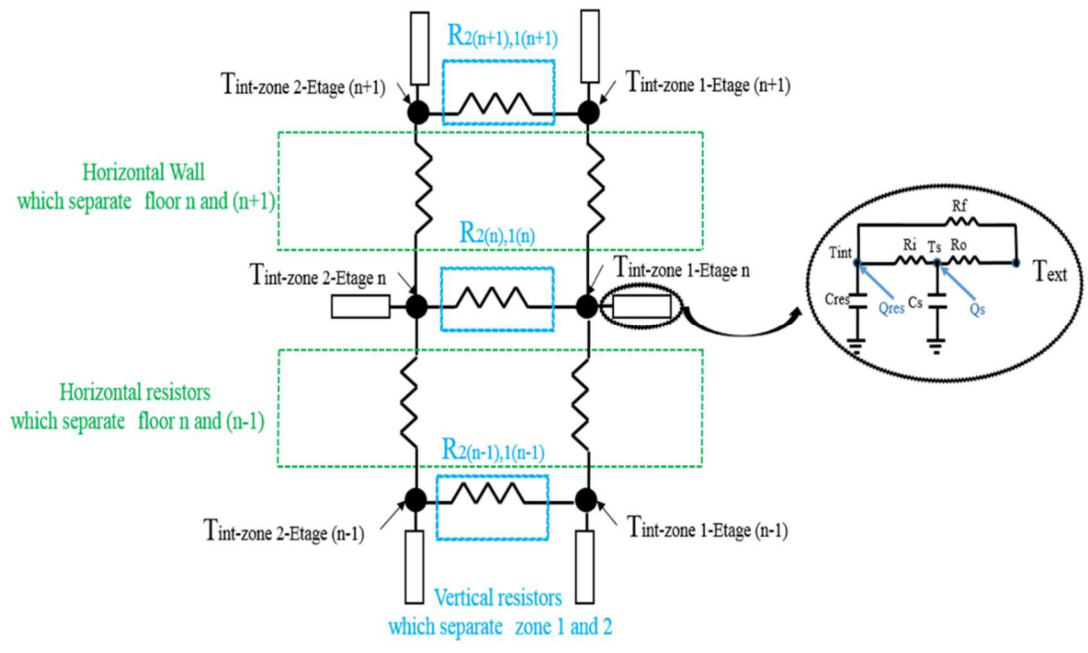
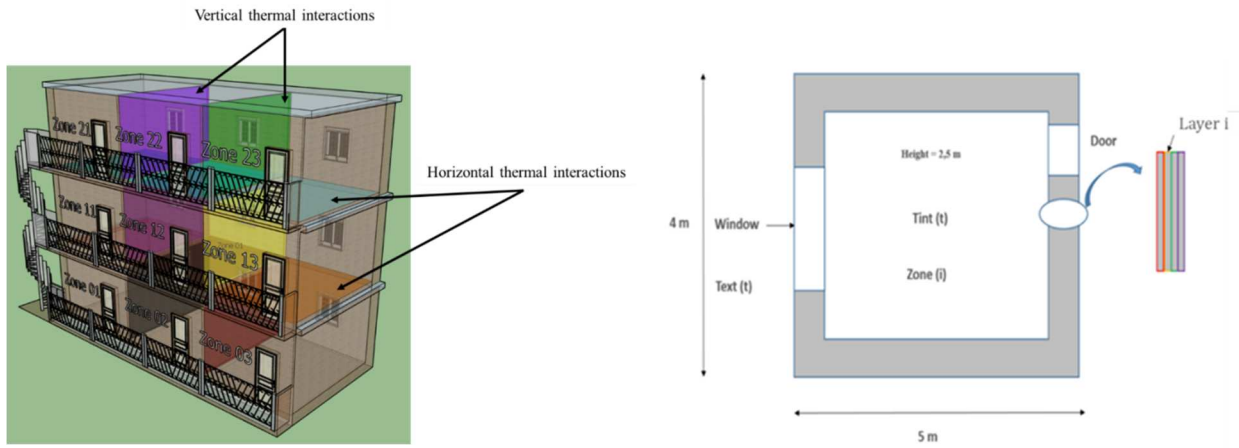

Fig. 1 Schematic figure of the RC model



Building model and the different thermal interactions

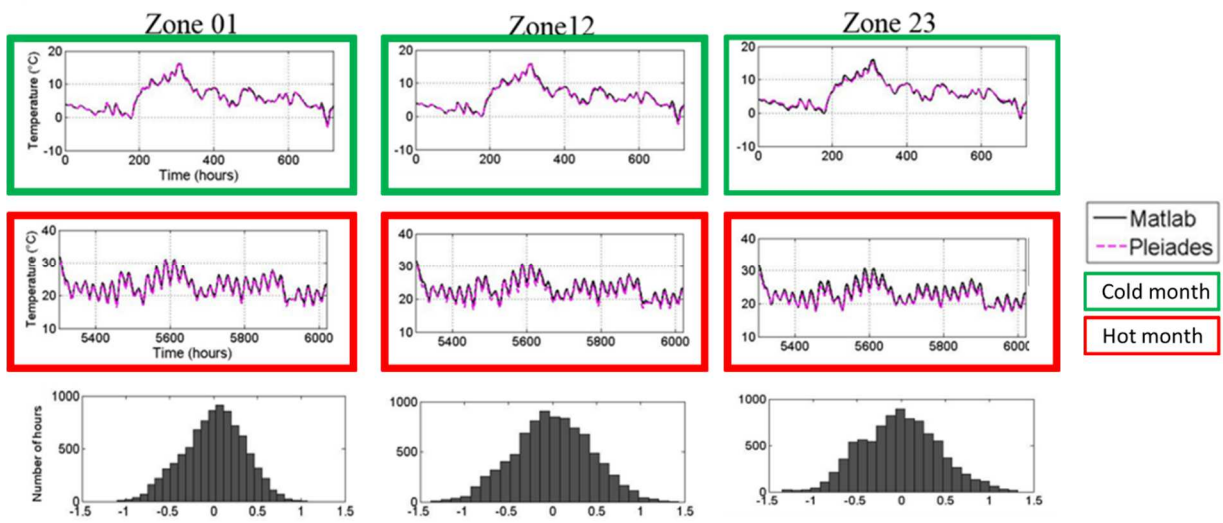

Fig. 2 Response of the model: black line (Matlab: R3C2), purple line (Pleiades), Distribution of indoor temperature error

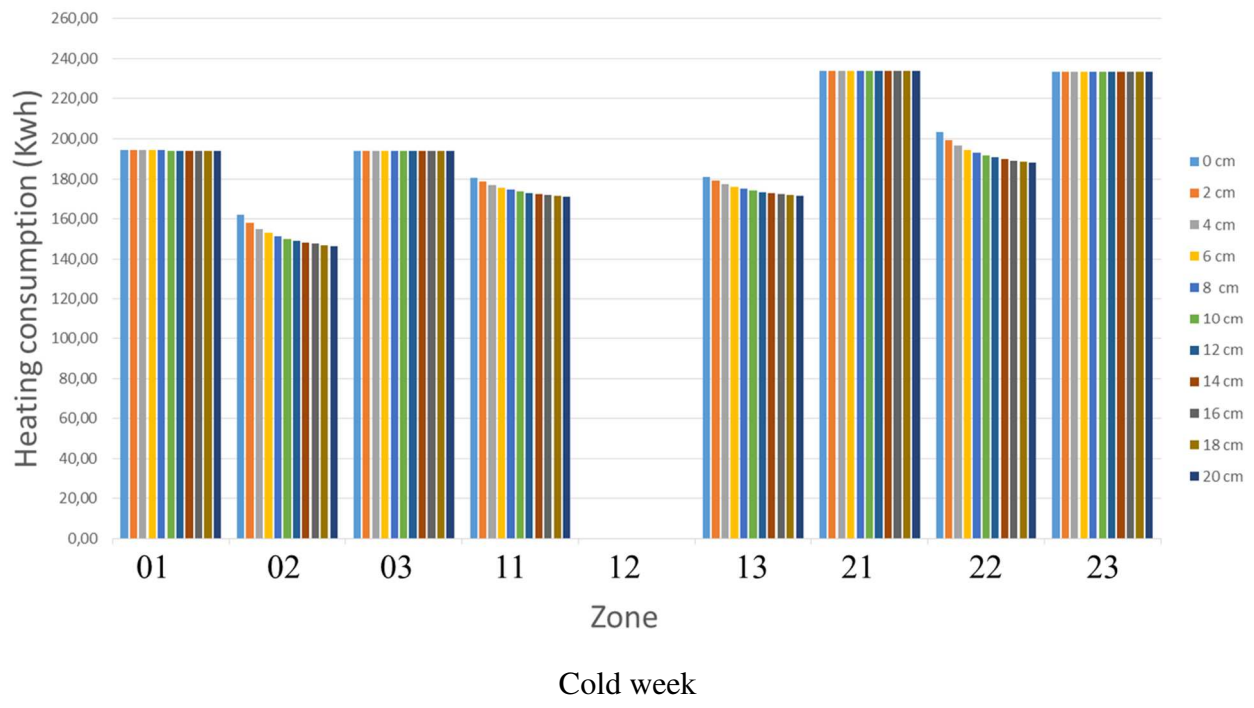

Fig. 3 Indoor insulation of zone 12

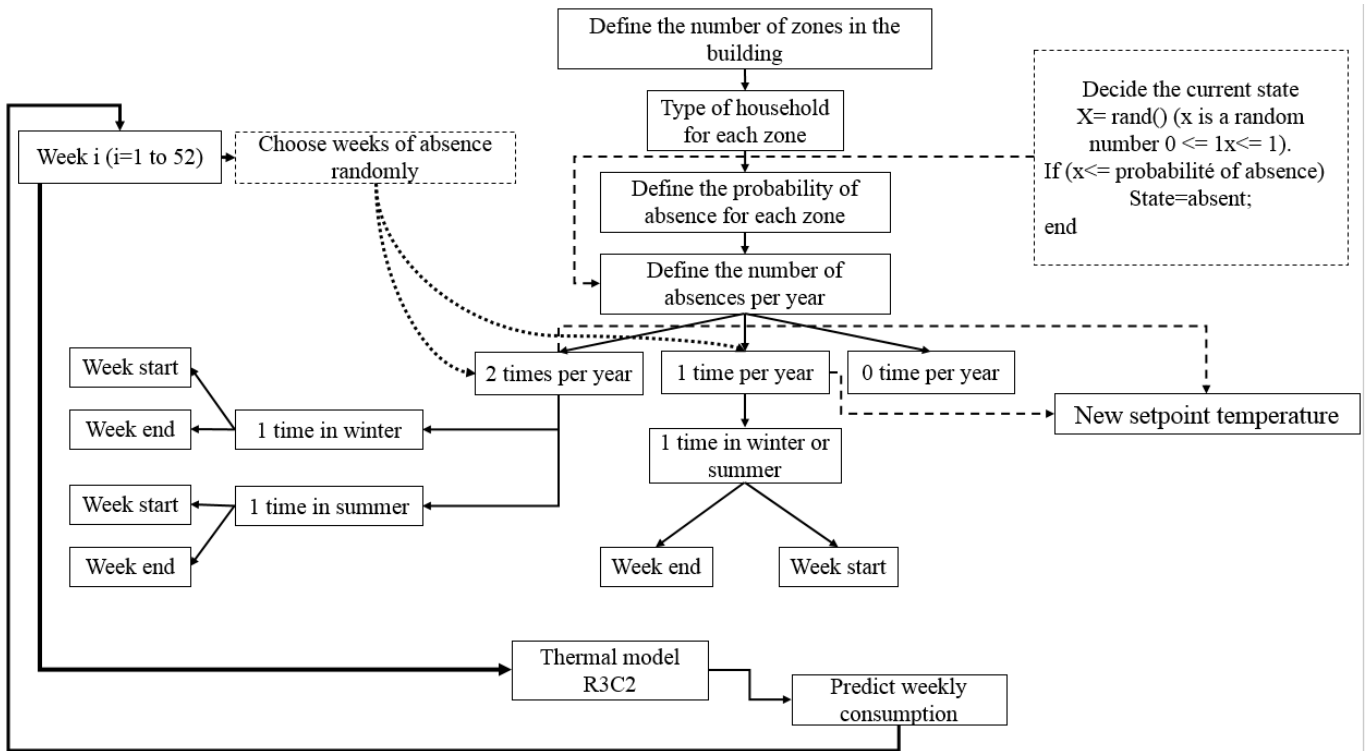

Fig. 4 The algorithm workflow

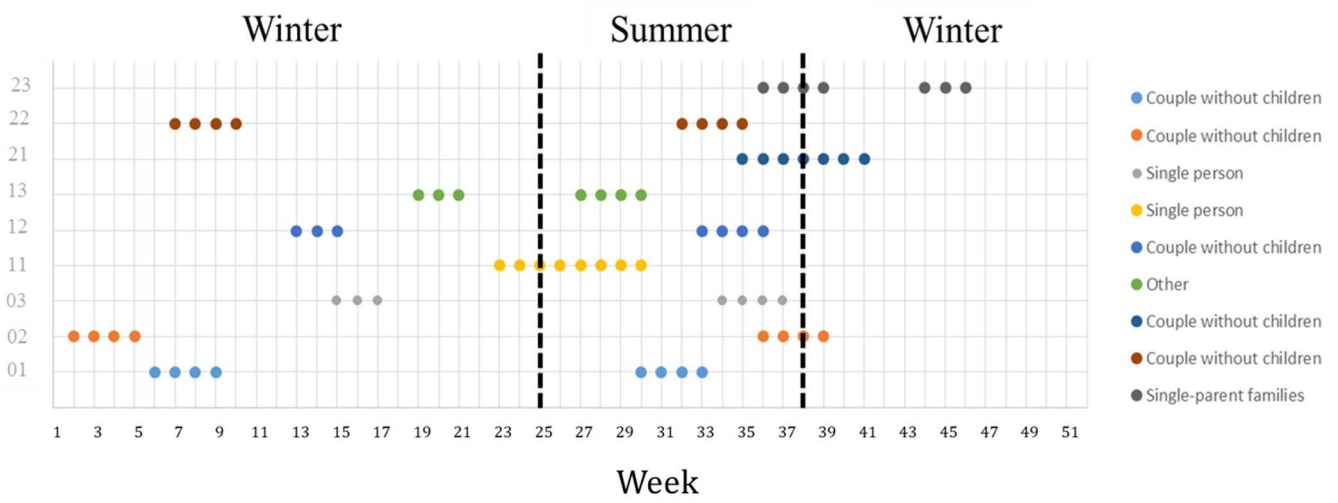
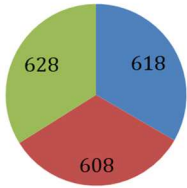
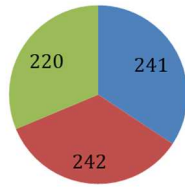

Fig. 5 Example for vacancy period for each zone (for one simulation)

Two times per year



One time per year



0 time per year

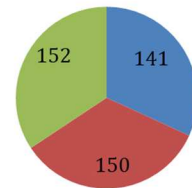

■ Apartment 01 ■ Apartment 02 ■ Apartment 03 ■ Apartment 01 ■ Apartment 02 ■ Apartment 03 ■ Apartment 01 ■ Apartment 02 ■ Apartment 03

Fig. 6 Number of absences per year for 1000 simulations for apartments 01, 02 and 03

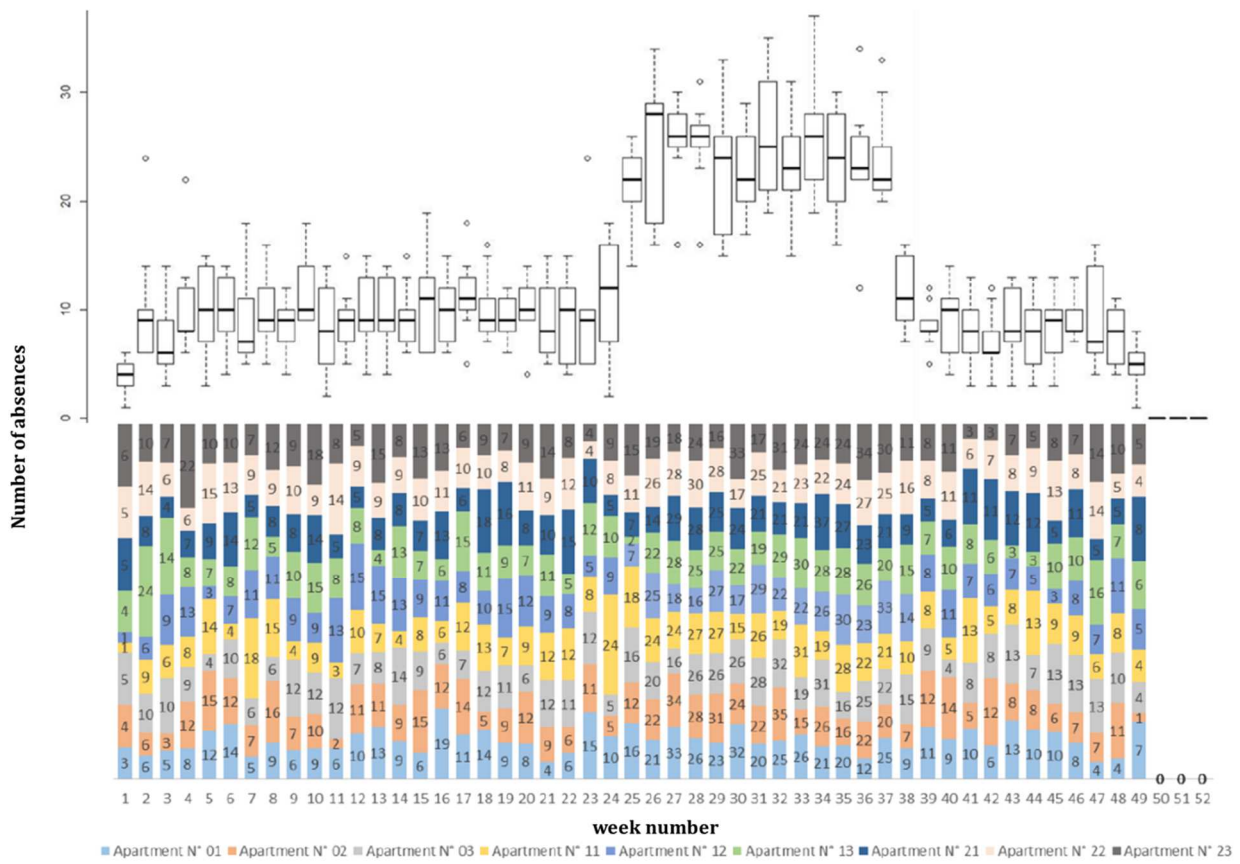

Fig. 7 Number of absences over a year for all zones: two times per year

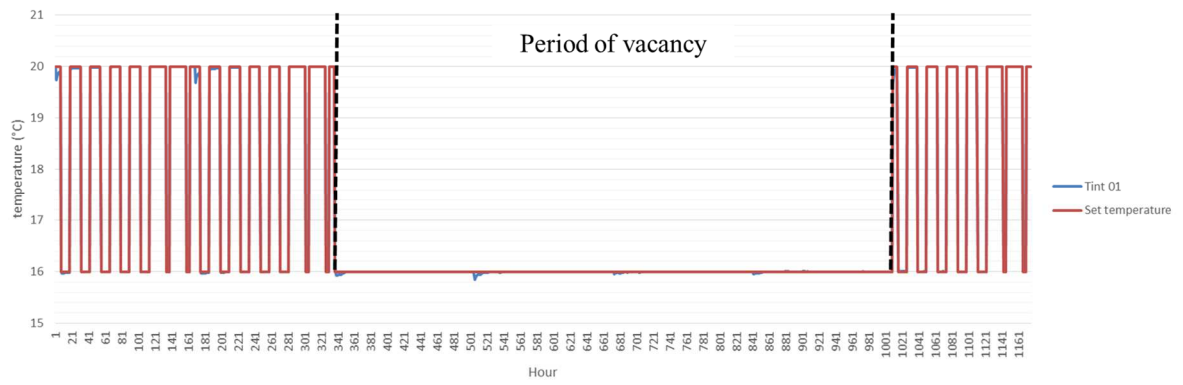

Fig. 8 Evolution of the internal temperature (blue) and the set point temperature (red) for zone 01

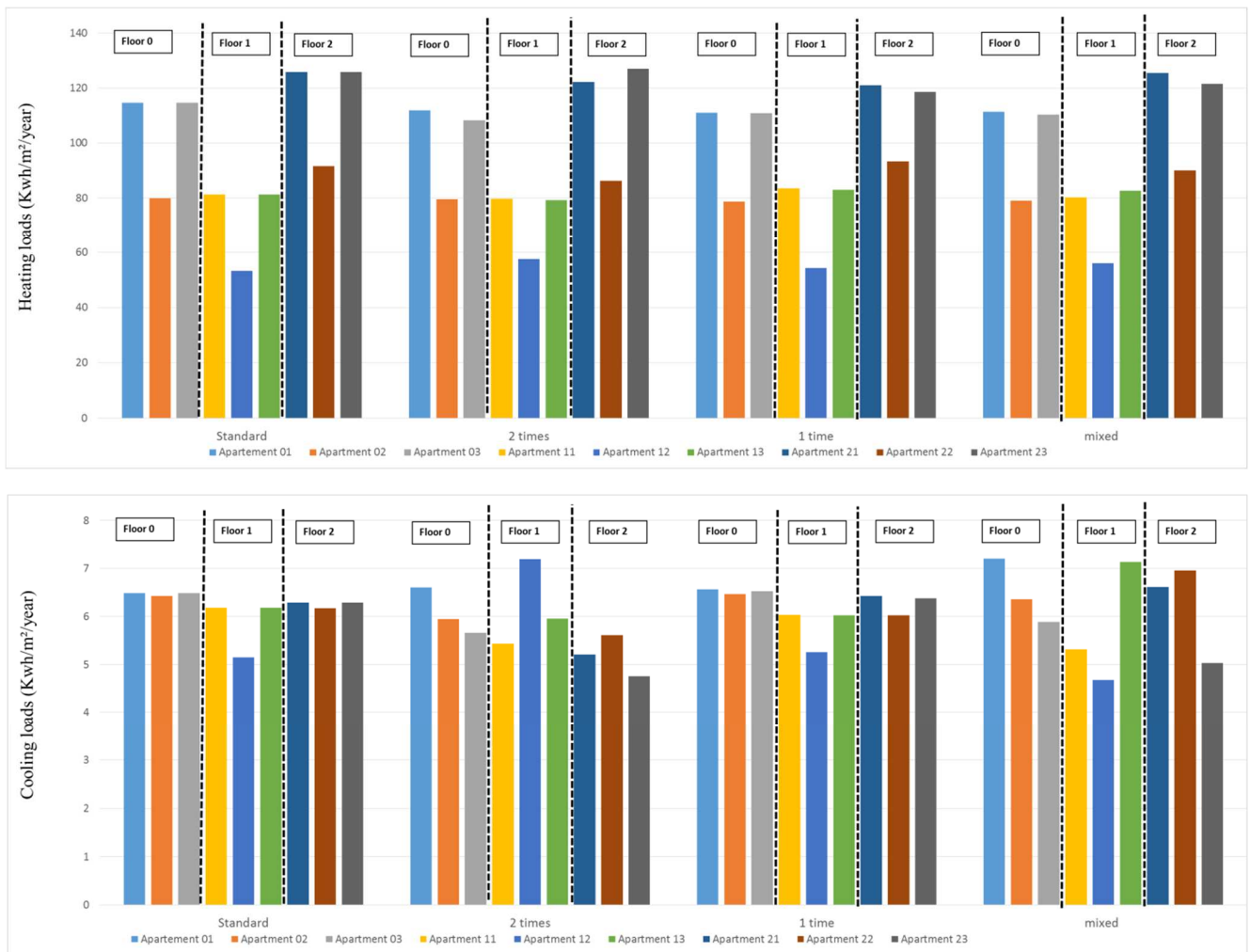

Fig. 9 Yearly space heating-cooling thermal load (KWh/m² of heated and cooled area) per zone and according to the number of absences per year

List of Tables

Tab. 1 Parameters of the R3C2 model

Tab. 2 Composition and thermal proprieties

Tab. 3 studies case.

Tab. 4 Heating loads (kWh/week) for the different case studies: cold week

Tab. 5 Cooling loads (Kwh/week) for the different case studies: hot week

Tab. 6 Distribution of holiday periods [65]

Tab. 1 Parameters of the R3C2 model

Parameter	Description	Formula
R_i (K/W)	Internal resistance	$\frac{1}{S_{\text{wallV}} \times h_{\text{iwallV}} + S_{\text{roof}} \times h_{\text{iroof}} + S_{\text{floor}} \times h_{\text{ifloor}}}$
R_o (K/W)	Outer resistance	$R_o = \frac{1}{U_{\text{office}}}$
R_f (K/W)	Losses through openings (windows) and due to air infiltration	$\frac{R_{\text{infiltration}} \times R_{\text{Window}}}{R_{\text{infiltration}} + R_{\text{Window}}}$
C_s (J/K)	Capacity of structure walls	$C_s = \text{Daily capacity} \times S_{\text{office}}$
C_{res} (J/K)	Indoor capacity of the building	$C_{\text{res}} = \rho_{\text{air}} \times C_{\text{air}} \times V_{\text{air}} + \text{Impact of furnitures on air capacity}$
Q_s (W)	Solar flux	
Q_{res} (W)	Heating power inputs and Internal gain	

Tab. 2 Composition and thermal proprieties

Materials	Thickness (mm)	Thermal conductivity (W/m.K)
Vertical walls		
Terracotta	50	1.15
LDR	100	0.041
Terracotta	160	1.75
Plaster	10	0.420
Low floor		
Plaster	50	1.15
LDR	100	0.041
Concrete	160	1.75
Plaster	10	0.420
Roof		
Terracotta	50	1.15
LDR	100	0.041
Terracotta	160	1.75
Plaster	10	0.420
Partition		
Plasterboard	13	0.325
Air blade	15	0.094
Plasterboard	13	0.325
Intermediate floor		
Concrete	200	1.75
Mortar	50	1.15
Tiling	20	1.7
Door		
		U_w (W/K.m²)
Area (m ²)	1.7	5
Windows		
		U_w (W/K.m²)
Area (m ²)	2.25	3.536

Tab. 3 studies case.

Cases	State
Standard	All zones are occupied
Case 1	Zone 01 unoccupied
Case 2	Zone 02 unoccupied
Case 3	Zone 11 unoccupied
Case 4	Zone 12 unoccupied
Case 5	Zone 21 unoccupied
Case 6	Zone 22 unoccupied

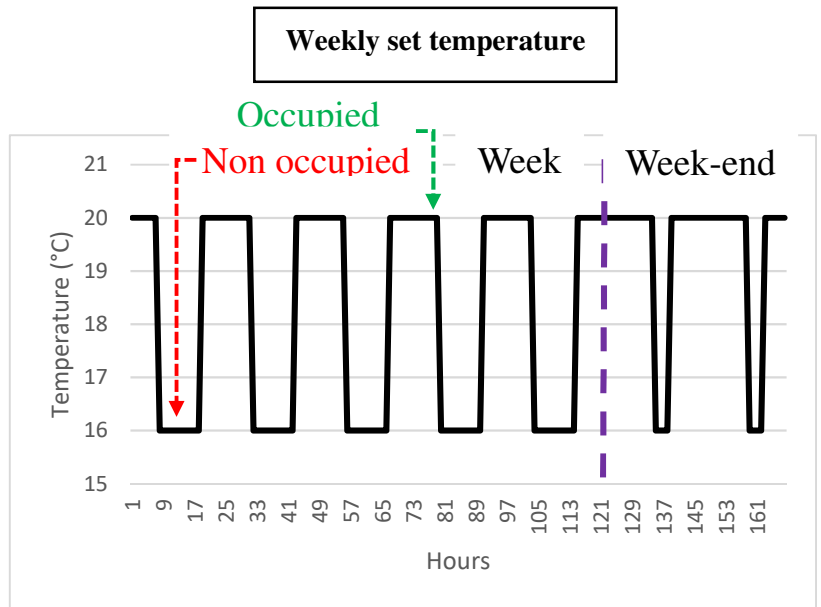

Tab. 4 Heating loads (kWh/week) for the different case studies: cold week

Zone	Standard	Case 1	Case 2	Case 3	Case 4	Case 5	Case 6
01	194,1	0	214,7	227,5	194,1	194,1	194,1
02	138,8	166,9	0	138,8	162	138,8	138,8
03	194,1	194,1	214,7	194,1	194	194,1	194,1
11	165,4	210,8	165,4	0	180,4	214,2	165,4
12	115,6	115,6	148,1	136,7	0	115,6	153
13	165,4	165,4	165,4	165,4	180,9	165,4	165,4
21	233,7	233,7	233,7	267,6	233,7	0	257,784
22	180,2	180,2	180,2	180,2	203,4	210,3	0
23	233,4	233,4	233,4	233,4	233,3	233,4	257,4
Total	1620,9	1500,4	1555,9	1544	<u>1582,3</u>	1466,3	1526,2
Max	<u>1582,3</u>						
Min	1466,3						

Tab. 5 Cooling loads (Kwh/week) for the different case studies: hot week

Zone	Standard	Case 1	Case 2	Case 3	Case 4	Case 5	Case 6
01	95,9	0	106,3	112,2	95,9	95,9	95,9
02	71,7	85,3	0	71,7	83,3	71,7	71,7
03	95,9	95,9	106,3	95,9	95,9	95,9	95,9
11	81,3	103,7	81,3	0	88,9	105	81,3
12	58,7	58,7	75,3	69	0	58,7	77,4
13	81,3	81,3	81,3	81,3	88,9	81,3	81,3
21	113,7	113,7	113,7	130,1	113,7	0	125,5
22	91,2	91,2	91,2	91,2	102,8	105,5	0
23	113,6	113,6	113,6	113,6	113,6	113,6	125,3
Total	803,6	743,6	769,9	765,3	<u>783,3</u>	727,9	754,6
Max	783,3						
Min	727,9						

Tab. 6 Distribution of holiday periods (INSEE 2004 [65])

Period	Holiday departure rate %		Average number of days	
	Summer	Winter	Summer	Winter
Type of household				
Single person	50,3	32,3	20,9	14,3
Couple without children	58,2	35,4	22,8	18,2
Couple with children	63,0	32,3	23,7	16,5
Single-parent families	55,2	26,3	19,3	12,3
Other	43,0	21,5	21,9	14,5