



**HAL**  
open science

## **Towards global indicator of durability performance and carbon footprint of clinker-slag-limestone cement-based concrete exposed to carbonation**

Imane Elkhaldi, Emmanuel Rozière, Philippe Turcry, Ahmed Loukili

### ► To cite this version:

Imane Elkhaldi, Emmanuel Rozière, Philippe Turcry, Ahmed Loukili. Towards global indicator of durability performance and carbon footprint of clinker-slag-limestone cement-based concrete exposed to carbonation. *Journal of Cleaner Production*, 2022, 380, pp.134876. <10.1016/j.jclepro.2022.134876>. <hal-04115746>

**HAL Id: hal-04115746**

**<https://hal.science/hal-04115746v1>**

Submitted on 27 Jan 2025

**HAL** is a multi-disciplinary open access archive for the deposit and dissemination of scientific research documents, whether they are published or not. The documents may come from teaching and research institutions in France or abroad, or from public or private research centers.

L'archive ouverte pluridisciplinaire **HAL**, est destinée au dépôt et à la diffusion de documents scientifiques de niveau recherche, publiés ou non, émanant des établissements d'enseignement et de recherche français ou étrangers, des laboratoires publics ou privés.



Distributed under a Creative Commons CC BY-NC 4.0 - Attribution - Non-commercial use - International License

# 1      **Towards global indicator of durability performance and** 2      **carbon footprint of clinker-slag-limestone cement-based** 3      **concrete exposed to carbonation**

4      Imane ELKHALDI<sup>1,2</sup>, Emmanuel ROZIERE<sup>1\*</sup>, Philippe Turcry<sup>3</sup>, Ahmed LOUKILI<sup>1</sup>

5      <sup>1</sup> Institut de recherche en génie civil et mécanique, UMR CNRS 6183, Ecole Centrale de Nantes, 44321, Nantes cedex 3,  
6      France

7      <sup>2</sup> Edycem, Rue du Fléchet, 85600 Boufféré, France

8      <sup>3</sup> La Rochelle University, LaSIE UMR CNRS 7356, Avenue Michel Crepeau, 17042, La Rochelle Cedex 1, France

9      \* Corresponding author, [emmanuel.roziere@ec-nantes.fr](mailto:emmanuel.roziere@ec-nantes.fr)

## 10     **Abstract**

11     This article aims at defining an effective global warming potential criterion for qualifying a  
12     concrete mixture based on a CO<sub>2</sub> calculation and durability performance tests, as well as  
13     understanding the parameters that influence the duration of initiation and propagation of  
14     corrosion in concretes exposed to carbonation-induced corrosion. An experimental study was  
15     conducted in order to assess the resistance to carbonation and the electrical resistivity for  
16     concretes made of multi-composite cements with ground-granulated blast furnace slag  
17     (GGBS) and limestone in the limits of new cement European standard EN 197-5, and to  
18     understand the link between these properties and the composition of the cements. A model is  
19     presented which allows to predict the service life of the concrete cover from the material data  
20     of the concrete (accelerated carbonation rate, electrical resistivity), environmental parameters  
21     (HR, T, CO<sub>2</sub>) and minimum cover. It was found that the reactive CaO content of cements  
22     influences the carbonation rate of concrete, and the electrical resistivity and the GGBS  
23     content of cements were found to have a good correlation. The model used allows comparing  
24     the studied cements from the CO<sub>2</sub> emission/service life ratios.

25     **Keywords:** Slag; Limestone; Durability; Carbonation; Resistivity; CO<sub>2</sub>

26

27

28

29

## 30 **1- Introduction**

31 The greenhouse gases emissions (GHGE) of building sector have two main causes: the energy  
32 used for heating, cooling, and lighting the buildings and the production of construction  
33 materials. Historically, environmental regulations have first focused on energy efficiency of  
34 buildings by reducing their energy consumption but the recent regulations, such as French  
35 environmental regulation RE2020, also set targets the GHGE associated to materials  
36 throughout their whole life cycle. This performance objective is called E+C- (Ministry for the  
37 ecological and solidary transition, 2020), as the energy efficiency must be improved and the  
38 carbon footprint should be reduced by using construction materials with low environmental  
39 impact. Thus, research works are recently moving towards exploring ways to reduce carbon  
40 emissions of concrete, which is the most widely used construction material. Cement is  
41 responsible for more than 75% of the carbon emissions of concrete from its manufacturing  
42 phase to its placement (Di Filippo et al., 2019). This is mainly due to clinker production  
43 which is both energy-intensive and polluting. The CO<sub>2</sub> emissions related to the production of  
44 cement represent 4 to 5% of all greenhouse gases produced worldwide in 2019 (IPCC, 2022).  
45 Nonetheless, normatively speaking, there is no regulatory definition of “low-carbon  
46 concrete”. In the literature, several indicators have been defined, such as the carbon cost of 1  
47 MPa compressive strength in (Bolte et al., 2019). This has also been designated by CO<sub>2</sub>  
48 efficiency to characterize low carbon concrete (Yang et al., 2017). This concept is interesting  
49 as it takes into account the performance of the concrete that represents its functional unit from  
50 a life cycle analysis (LCA) point of view. However, it does not take into account the  
51 durability aspect of concrete, which is equally important. The long term performance of  
52 concrete is actually an important factor to consider since maintenance work on reinforced  
53 concrete structures induces a significant carbon cost which is added to the primary carbon  
54 cost of the structure (Gartner, 2004).

55 Compressive strength is not a fully satisfactory durability indicator, as it cannot provide a  
56 reliable estimation of the service life (SL) duration of reinforced concrete structures, which  
57 depends on several factors, especially environmental actions. In the current concrete standard  
58 in Europe (EN 206-1), the environmental conditions are represented by the exposure class.  
59 For the general case of buildings, which are neither close to the sea nor exposed to chemical  
60 attacks, the most considered exposure class is XC class (XC1 to XC4) which concerns  
61 concretes subjected to the risk of corrosion induced by carbonation The environmental  
62 conditions concerned by this exposure class are described in table 1.

**Table 1: Environmental conditions described by XC exposure class**

	<b>Description of the environment</b>
<b>XC1</b>	Permanently dry or wet
<b>XC2</b>	Wet, rarely dry
<b>XC3</b>	Moderate humidity
<b>XC4</b>	Alternating wet and dry

64

65 This standard includes deemed-to-satisfy provisions, i.e. for each class the maximum W/C  
66 ratio, the minimum cement content as well as requirements on the contents of mineral  
67 additions (MAs) which can be used as a MA as a replacement of Portland cement with a high  
68 clinker content (> 80%). To deviate from these prescriptions, it remains possible to use  
69 performance-based specifications (Rozière et al., 2009).

70 In parallel with the new environmental regulation, the new cement standard EN 197-5 (2021)  
71 has also been published. It describes two categories of ternary cements with lower clinker  
72 contents, namely Portland CEM II/C-M cements that incorporates a higher percentage of  
73 MAs (up to 50%) than existing CEM II Portland cements, and a new category of cements  
74 which is CEM VI with a clinker content ranging from 35 to 49%. This standard aims at  
75 facilitating the integration of cements with low clinker content into the market by including  
76 them in a regulatory framework. However, as long as “low-carbon concrete” has not been  
77 defined, it cannot be said that CEM II/C-M and CEM VI are “low-carbon cements”; it  
78 actually depend on the durability of concretes made with these cements.

79 Ternary cements based on a MA rich in reactive silico-aluminates, such as metakaolin and  
80 ground granulated blast furnace slag (GGBS) have been the subject of many research works  
81 recently (Arumugam, 2022). The particular interest in these binders lies in their great  
82 potential to maximize the clinker replacement rate (Proske et al., 2018). The synergy between  
83 aluminates and limestone enhances the mechanical properties in the short and long term. The  
84 nucleation effect of limestone powder actually accelerates the hydration of the clinker at early  
85 age (Palm et al., 2016), and the GGBS, given its latent hydraulicity and its pozzolanic  
86 properties, improves the mechanical properties in the long term (Giergiczny, 2019). In  
87 addition, the reaction of the calcium carbonates with the aluminates from the clinker and the  
88 GGBS, stabilizes ettringite and carboaluminates, which densifies the microstructure

89 (Matschei et al., 2007). The hydration and microstructure of this type of binders has been  
90 largely studied in the literature (Adu-Amankwah, 2016).

91 However, few data can be found on the durability of concrete based on these cements with  
92 respect to corrosion induced by carbonation. The carbonation risk of these binders has been  
93 studied in (Bolte et al., 2019) and (Proske et al., 2018). In both papers, it was shown that the  
94 carbonation resistance of concrete containing composite cements is similar to that of concrete  
95 made with CEM III/A GGBS cements with the same mechanical strength but remains low  
96 compared to Portland cement. The carbonation rate has been found to be inversely  
97 proportional to the clinker content of the cements (Bolte et al., 2019). The resistance to  
98 carbonation is an important parameter since it provides information on the initiation phase of  
99 corrosion, but remains insufficient to quantify the service life of concrete structures with  
100 respect to corrosion induced by carbonation. The corrosion propagation phase is actually  
101 significant under certain environmental conditions (Farissi, 2020; Tuutti, 1982). According to  
102 (Tuutti, 1982) , this phase depends on the electrical resistivity of the concrete which provides  
103 information on the corrosion rate of the reinforcements (Andrade, 2010). Data on the  
104 electrical resistivity ( $\rho$ ) or the conductivity ( $1/\rho$ ) of cementitious materials containing GGBS  
105 have been published (Alonso et al., 2012), but there are very few published data about  
106 electrical resistivity of concretes containing clinker-GGBS-limestone (K-S-LL) multi-  
107 composite cements.

108 This article deals with the ternary cements K-S-LL within the scope of the new cement  
109 European standard EN 197-5. The approach of this study aims at evaluating the service life  
110 duration, the CO<sub>2</sub> emissions related to the production of concretes made up with K-S-LL  
111 cements and binary limestone and GGBS cements respectively. The purpose of the  
112 experimental study is to assess the influence of durability parameters on the SL of concrete  
113 exposed to carbonation-induced corrosion, namely carbonation resistance and electrical  
114 resistivity, as well as to understand the link between those properties and cement composition.  
115 The results are incorporated into an empirical model to predict the service life of the concretes  
116 studied. The ratio of the CO<sub>2</sub> emissions related to the production of concrete to the service life  
117 will be used as a new indicator to estimate the interest in using the new cements.

118

119

120

121 **2- Experimental program and procedures**

122 2.1. Materials and mixtures

123 The ternary cements were manufactured in the laboratory using a V-shaped rotary mixer from  
 124 four powders: ordinary Portland cement (CEM I), limestone Portland cement (CEM II/B-LL)  
 125 with a limestone filler (LL) content of 30% by mass, ground granulated blast furnace GGBS  
 126 (GGBS), and gypsum. CEM I and CEMII/B-LL were commercial cements made with the  
 127 same clinker (K). The chemical composition and the physical properties of the raw materials  
 128 are given in table 2. The particle size distribution of the raw materials are given in figure 2.

129 **Table 2: Chemical and physical properties of the raw powders**

	CEM I	CEMII/B-LL	GGBS
<b><i>Chemical Composition [%]</i></b>			
CaO	63.6	60.4	41.6
SiO <sub>2</sub>	20.1	15.9	35.9
Al <sub>2</sub> O <sub>3</sub>	4.4	3.4	11.7
Fe <sub>2</sub> O <sub>3</sub>	2.2	1.7	0.5
SO <sub>3</sub>	3.3	2.9	0.1
MgO	4	3.1	7.4
TiO <sub>2</sub>	0.2	-	0.7
S--	0.02	-	0.7
Na <sub>2</sub> O <sub>eq</sub>	0.6	0.42	0.58
Loss On Ignition (LOI)	1.4	12.5	-
Clinker percentage (%)	100	70	-
<b><i>Clinker Mineralogical composition [%]</i></b>			
C <sub>3</sub> S	67	68	-
C <sub>2</sub> S	11	10	-
C <sub>3</sub> A	9	9	-
C <sub>4</sub> AF	7	7	-
Gypsum	4.9	4.9	-
<b><i>Physical and mechanical properties</i></b>			
Density	3.14	3.01	2.9
Blaine surface [cm <sup>2</sup> /g]	4882	5168	>4200
Time of initial setting	1h55	2h36	-
f <sub>c2j</sub> (MPa)	44	25	-
f <sub>c28j</sub> (MPa)	63	44	-

131 The CaCO<sub>3</sub> content of limestone in CEM II/B-LL was 95.5%. Additional gypsum was  
132 incorporated in order to reach a Calcium sulfate/(Clinker+GGBS) ratio of at least 3% to have  
133 enough calcium sulphate to control the short-term hydration of the aluminates contained in  
134 both clinker and GGBS. The gypsum was the same as included in CEM I and CEM II/B-LL.

135 The compositions of studied cements are shown in table 3 and on the K-S-LL ternary diagram  
136 of figure 1. This diagram also includes the boundaries of new CEM II/C (green zone) and  
137 CEM VI (yellow zone) cements defined in standard EN 197-5 (EN 197-5:2021). The raw  
138 materials were proportioned by mass in order to obtain four different binders: 2 ternary  
139 binders C1 (CEM VI) and C3 (limit between CEM II/C and CEM VI), and 2 conventional  
140 binary cements, CEM II, limestone Portland cement, widely used today, and CEM III, which  
141 comply with the existing cement standard EN 197-1. CEM II and CEM III are used as  
142 references to evaluate the relevance of the new ternary cements. C1 and C3 have the same  
143 Limestone/Clinker (LL/K) ratio of 0.4, a preliminary study on 15 ternary cements showed that  
144 C1 and C3 cements had the same strength on standardized mortar from 7 days, and both  
145 concrete had the same characteristic strength (table 5). C1 and CEM III have the same clinker  
146 content with 15% of the slag substituted in limestone for C1. Studying these two cements  
147 allows to study the effect of limestone on the durability of concrete based on ternary cements  
148 with high clinker replacement.

149

**Table 3: Composition of the studied cements (mass proportions)**

Mix designation	Clinker	GGBS	Limestone	LL/K
CEM II	90	0	10	0.11
CEM III	35	65	0	0
C1	35	50	15	0.43
C3	50	30	20	0.40

150

151 The homogeneity of the powders prepared was confirmed using X-ray fluorescence  
152 spectrometry (XRF) analysis by determining the atomic composition of the raw and mixed  
153 powders. The theoretical composition calculated from the measured composition of the raw  
154 powders was compared to the actual measured composition of the mixed ones. The relative  
155 errors found were small especially for the preponderant elements, namely Ca and Si  
156 (maximum error < 2%)

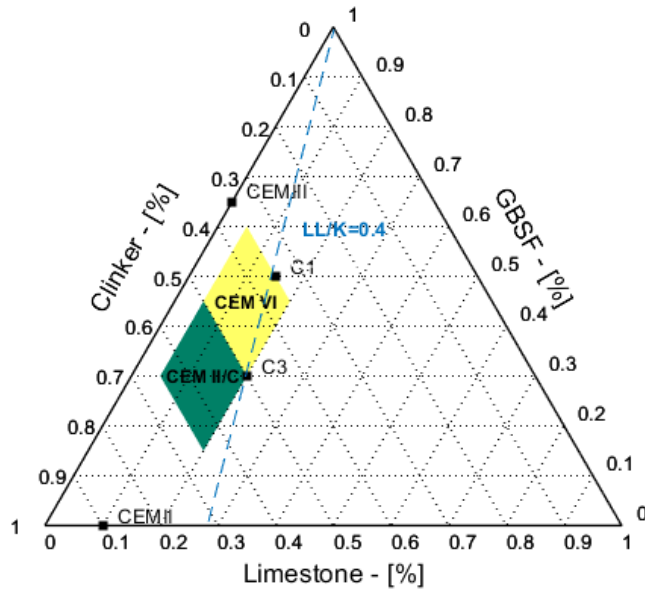

157

158 **Figure 1: Studied cements, and boundaries of new ternary cements CEM II/C and CEM VI**

159

160 Four concrete mixtures were designed keeping all the mass ratios constant; only the cement  
 161 composition varied. The properties of aggregates are given in Table 4. The particle size  
 162 distribution of the aggregates used is given in figure 2. A polycarboxylate-type plasticizer  
 163 showing a good compatibility with the binders studied was used. The plasticizer content was  
 164 adjusted to reach around 150 mm slump of fresh concrete. The compositions of concrete  
 165 mixtures comply with the requirements of the NF 206/CN standard with regard to the  
 166 maximum W/C ratios (0.65 and 0.60), the minimum cement content (260 and 280 kg/m<sup>3</sup>) for  
 167 XC1-XC2 and XC3-XC4 exposure classes respectively. It is noteworthy that the compressive  
 168 strengths obtained at 28 days comply with the minimum strength classes of 20 and 25 MPa  
 169 characteristic compressive strength respectively. The maximum aggregate size was 10 mm.  
 170 The concrete mixtures and properties are given in table 5 with  $f_{ck}$  the characteristic  
 171 compressive strength.

172

173

**Table 4: Physical properties of the aggregates**

Mix designation	Sand 0/4	Sand 0/2	Gravel 6.3/10
Mineralogy	Siliceous rolled sand	Amphibolite crushed sand	Amphibolite crushed gravel
Water absorption (%)	0.40	0.50	0.60
Density (kg/m <sup>3</sup> )	2620	2960	2960

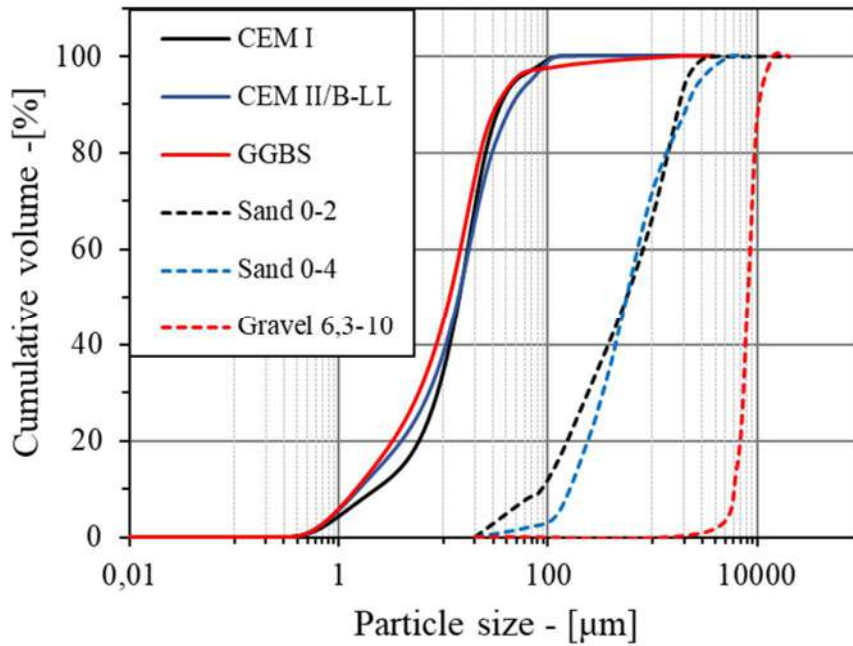

174

175

**Figure 2: Particle size distribution of the raw powders and aggregates**

176

177

**Table 5: Mixture composition (in kg/m<sup>3</sup>) and properties of the studied concretes**

	CEM II	CEM III	C1	C3
Sand 0/4		434		
Sand 0/2		424		
Gravel 6,3/10		1051		
Cement		313		
Water		188		
Plasticizer (%)	0.3	0.3	0.45	0.45
Paste volume (l)	292	290	290	291
W/C		0.60		
$f_{ck}$ (MPa) <sup>(*)</sup>	40.2	32.7	25.3	25.4

178

<sup>(\*)</sup>  $f_{ck}$  is the characteristic strength deduced from the average 28d strength according to

179

Eurocode 2.

180

## 2.2. Experimental program

181

The concrete and cement pastes prepared have the same W/C ratio. The concrete specimens

182

were demolded after 24 hours and kept in water for 90 days in a room at 20 °C. Six

183

cylindrical concrete specimens of  $\varnothing 110 \times 220$  mm<sup>3</sup> were manufactured for the accelerated

184

carbonation test and three cubic specimens of 150\*150\*150 mm<sup>3</sup> size for the electrical

185

resistivity tests.

186 Cylindrical cement paste samples of  $\text{Ø}25*50 \text{ mm}^3$  dimensions were prepared with the same  
187 W/C and cement composition as the studied concretes. Xanthan gum, which is a  
188 polysaccharide-based viscosity modifying admixture, was added to the cement paste to limit  
189 bleeding at proportions ranging from 0.6 to 1 wt% to the liquid fraction; as it was found to  
190 have limited effect on binders reactivity and cement hydration and therefore can be  
191 considered inert (Aboulayt et al., 2018). Xanthan gum was used at a constant W/C ratio. The  
192 cement pastes were demolded after 24 hours and kept in water in a room at 20 °C for 90 days  
193 to guarantee a degree of maturity comparable to the cement paste contained in the concretes.  
194 One paste sample was used to assess the microstructure of sound cement paste and another  
195 one was carbonated.

### 196 2.2.1. Durability tests:

#### 197 a) Accelerated carbonation test

198 The accelerated carbonation testing procedure was adapted from European standard  
199 prCEN/TS 12390-12 to increase its sensitivity to materials performance (Turcry et al., 2019).  
200 The samples were obtained by sawing in two  $\text{Ø}110*220 \text{ mm}^3$  specimens; the lower and upper  
201 part of the sample were covered by adhesive aluminum to allow lateral carbonation.  
202 Subsequently, the specimens underwent the following pre-treatment to promote optimal  
203 conditions to accelerate carbonation:

204 - Drying at 45 °C +/- 5 °C with 3 specimens of standardized mortar  $40*40*160 \text{ mm}^3$  made of  
205 CEM II/A-L prepared 35 days before the start date of drying. Drying lasts a minimum of 14  
206 days until the mass loss of the control mortar specimens reaches at least 5.5%.

207 - Humidification in a climatic room at 20 °C and 52% RH for 7 days.

208 The interest of these two steps is to ensure optimal carbonation conditions. The drying step  
209 favours the CO<sub>2</sub> diffusion through concrete porous network, then humidification results in  
210 higher water saturation in the external part of the samples, which restores an aqueous phase in  
211 the porosity allowing carbonation reactions to take place. After preconditioning, the samples  
212 were placed in a carbonation chamber at 20 °C, 65% RH and 3% CO<sub>2</sub>. The carbonation rate  
213 was estimated by monitoring the progress of the carbonation front at 0, 28, 42, and 70 days  
214 using phenolphthalein, on 3 specimens split in two.

215 For the cement pastes samples, the sample used for carbonation was cut into thin discs about  
216 5 mm thick to be carbonated in the same conditions as concrete specimens. Before putting

217 them in the carbonation chamber (20°C, 65% RH, 3% CO<sub>2</sub>), these discs were dried for 2  
218 hours at 40°C and placed in a room at 20°C and 50% RH for 24h to ensure optimal  
219 carbonation conditions without altering their phase composition. The carbonation time was 42  
220 days for all cement pastes. At the end of this period, a phenolphthalein test was carried out on  
221 a fragment of disc to check the complete carbonation of the disc.

#### 222 b) Electrical resistivity

223 The measurements were carried out on three cylindrical Ø75\*70 mm<sup>3</sup> specimens cored in the  
224 middle of cubic concrete samples and cut in two. The device consists of two halves insulating  
225 cylinders with 5 ring-electrodes equally spaced along the height (du Plooy et al., 2013).  
226 Figure 3 shows the arrangement of the electrodes and the measurement points. This  
227 configuration allows 4 measurement points on different slices of the sample and accounts for  
228 any heterogeneities. Indeed, it has been reported that the configuration with 4 measurement  
229 points gives more reliable results than that with two points (Hornbostel et al., 2013). The  
230 current is injected through two stainless steel disk electrodes, and the current measurement is  
231 made between two ring-electrodes. The measurement cell is connected to a commercial  
232 resistivity meter (Syscal Pro, Iris instrument). The current injected is a square alternating  
233 current at a frequency of 4Hz. The electrical resistivity is given by equation 1.

$$234 \quad \rho = G \frac{\Delta V}{I} \quad (1)$$

235  $\rho$ : is the electrical resistivity in ( $\Omega$ .m),  $\Delta V$  (V) is the measured potential difference, I (A) is  
236 the injected current and G is the geometric coefficient which is equal to the section to length  
237 A/L ratio (m). A is the cross-sectional area of the specimen and L is the length of the  
238 specimen.

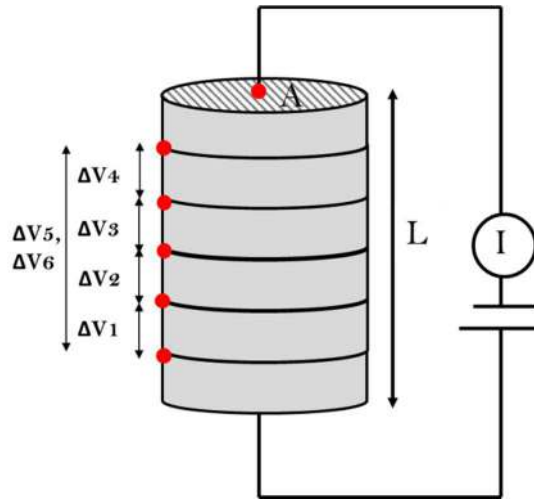

239

240 **Figure 3: Schematic view of the resistivity measurement, adapted from (du Plooy et al., 2013)**

241 The G coefficients for each measurement range are calculated by numerical modelling, the  
 242 details are provided in (du Plooy et al., 2013).

243 **2.2.2. Microstructural characterization**

244 In order to assess the effect of hydration and carbonation on the pore size distribution (PSD),  
 245 MIP analyses were performed on non-carbonated and carbonated concrete cubes. The cubes  
 246 were cut from partially carbonated cylindrical  $\varnothing 75 \times 70$  mm<sup>3</sup> specimens with a minimum  
 247 carbonation depth of 13 mm. The non-carbonated samples were taken from the center and the  
 248 carbonated one from the carbonated external layer. Measurements were carried out on with a  
 249 Micromeritics AUTOPORE IV 9500 porosimeter at increasing pressures up to 400 MPa  
 250 which corresponds to a minimum pore radius of 1.5 nm. The uncertainty on the threshold pore  
 251 diameter was  $\pm 5\%$  of the average value.

252 TGA analyses were performed on 50 mg sample of ground carbonated (C) and non  
 253 carbonated (NC) cement pastes. Hydration was stopped before the test using isopropanol  
 254 (Cardinaud et al., 2021). The temperature increased from 20 to 1000 °C at a rate of 10  
 255 °C/min. Water loss between 40 °C and 400 °C refers to bound water (**BW**<sub>40-400°C</sub>) and it is  
 256 attributed to C-S-H, ettringite, AFm and carboaluminates decomposition. It is calculated using  
 257 stepwise method and reported to anhydrous cement (equation 2). The CO<sub>2</sub> which decomposes  
 258 from the initial limestone ( $L_{ini}$ ) present in the cement is added to the remaining mass after  
 259 900°C heating to obtain the anhydrous cement.:

260 
$$m_{anh} = m_{900^{\circ}C} + L_{ini} \frac{M_{CO_2}}{M_{CaCO_3}} \quad (2)$$

261 with:  $m_{900^{\circ}\text{C}}$  the weight at  $900^{\circ}\text{C}$ ,  $L_{ini}$  the percentage of the initial limestone present in the  
262 cement, and  $M_{\text{CO}_2}$  and  $M_{\text{CaCO}_3}$  the molar masses of  $\text{CO}_2$  and  $\text{CaCO}_3$  which are equal to 44  
263 g/mol and 100 g/mol respectively.

264 Water loss between  $400^{\circ}\text{C}$  and  $550^{\circ}\text{C}$  is attributed to portlandite decomposition. It was  
265 calculated using tangent method (Kocaba, 2009). The portlandite (**CH**) content was then  
266 calculated using the molar masses of CH and water. For non carbonated cement paste, CH  
267 content was corrected with the mass loss between 550 and 850 C corresponding to the  $\text{CO}_2$   
268 released by the decomposition of  $\text{CaCO}_3$  formed from carbonated portlandite according to  
269 (Cardinaud et al., 2021). The total CH content was reported to the mass of anhydrous cement.  
270 The sum of the two water losses mentioned above refers to the total bound water (**BW<sub>40-550°C</sub>**)  
271 which gives information about the hydration degree of the binder. The uncertainty on the CH  
272 content was  $\pm 4\%$  of the average value, and the uncertainty on the **BW<sub>40-550°C</sub>** content was  $\pm 2\%$   
273 of the average value.

274 XRD analysis was performed on carbonated and non carbonated ground cement pastes using  
275 a Malvern Panalytical Aeris instrument. Scanning program consisted in rotating between 7  
276 and  $70^{\circ}2\theta$  with a step size of  $0.01^{\circ}2\theta$  and a 480.165 ms per step.

### 277 **3- Service life prediction model**

278 The service life (SL) of concrete structures is largely determined by the durability of its  
279 concrete cover, which protects steel reinforcement from the corrosion induced by  
280 environmental actions. Theoretically, the SL of the cover can be quantified based on the  
281 environment of the structure, the mechanisms that govern aggressive agent penetration, and  
282 the properties of the concrete.

283 According to the conceptual model of Tuutti (Tuutti, 1982) (figure 4) the SL of reinforced  
284 concrete structure can be divided into two phases: initiation and propagation phase.

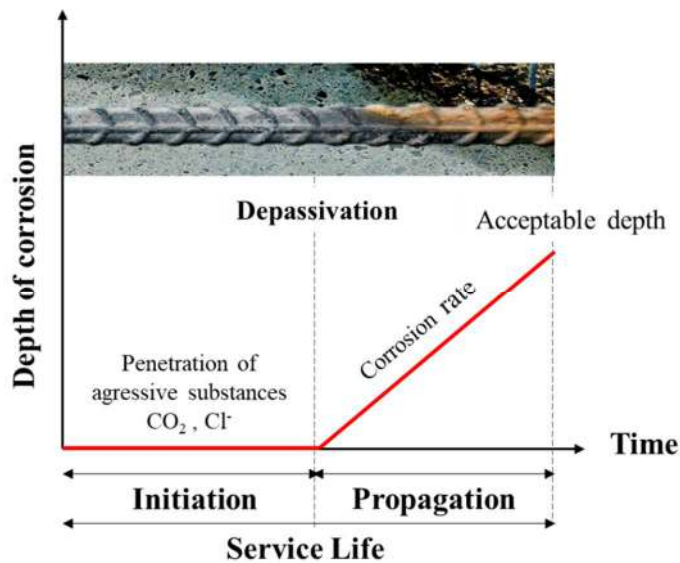

285

286

**Figure 4: Service life phases according to Tuutti's model (Tuutti, 1982)**

287

288 -The initiation phase characterizes the period when the aggressive agents (CO<sub>2</sub>, Cl<sup>-</sup>) penetrate  
 289 the concrete cover and reach the reinforcement. This diffusion is accompanied by a change in  
 290 the microstructure and the pore solution.

291 - The propagation phase: Corrosion does not occur totally once the carbonation front or  
 292 chlorides reach the reinforcement. The reinforcement corrodes gradually until it reaches a  
 293 critical corrosion depth ( $X_{crit}$ ), which corresponds to a diameter loss and results in a crack  
 294 opening on the concrete surface. For a fracture opening of 0.1 mm, there are empirical  
 295 formulas that give  $X_{crit}$  (Torres-Acosta and Sagues, 2004). The propagation phase can be  
 296 divided into several sub-periods describing different limit states (Markeset and Myrdal,  
 297 2008). In our study, we consider only the first limit state, i.e. the appearance of the first cracks  
 298 due to corrosion.

299 There are models based on a performance-based approach to predict the corrosion initiation  
 300 phase, such as the fib model (fib Model-Code, 2010). These models were mostly developed  
 301 from concretes made with Portland cement and binary binders. As a result, their predictions  
 302 need some improvements when it comes to the impact of material properties (concretes with  
 303 high replacements of clinker by MAs) and exposure conditions. It should also be emphasized  
 304 that most of existing models only deal with the initial phase of corrosion.

305 The model shown below was developed by A. El Farissi (Farissi, 2020). It uses empirical  
 306 laws derived from the exploitation of a database of 42 concretes of various mixture

307 proportions with various types of aggregates and MAs as part of a French National project  
308 (PerfDuB), as well as data from the literature, to quantify the phase of corrosion initiation and  
309 propagation(Carcasses et al., 2021).

### 310 3.1. Initiation period

311 The modeling procedure is explained in Figure 5. Diffusion is assumed to control the  
312 evolution of the carbonation depth ( $x_c$ ) as a function of time, as done in most analytical  
313 carbonation models, such as the fib model (fib model-code 2010). As a result, the carbonation  
314 front  $x_c$  (mm) is expressed as a function of the square root of time ( $\text{year}^{1/2}$ ) (equation 3):

$$315 \quad x_c(t) = V_{NAT} \sqrt{t_{eff}} \quad (3)$$

316 Where :

$$317 \quad V_{NAT} = V_{NAT,0} \cdot k_{RH,ini} \quad (4)$$

318  $V_{NAT}$  ( $\text{mm} \cdot \text{year}^{-1/2}$ ): the natural carbonation rate under actual environmental conditions (T,  
319 RH)

320  $V_{NAT,0}$  ( $\text{mm} \cdot \text{year}^{-1/2}$ ) : the carbonation rate under reference conditions (T=20°C, RH=65%)

321  $k_{RH,ini}$ : relative humidity parameter related to the corrosion initiation period

322  $t_{eff}$  ( $\text{years}$ ): the effective carbonation time

323 Each term will be discussed and quantified separately in the following paragraphs.

324 Carbonation rate is influenced by both material properties and environmental factors. The  
325 model accounts for each parameter by decomposing each effect into distinct empirical  
326 functions.  $V_{NAT,0}$  can be estimated from the results of an accelerated carbonation test because  
327 atmospheric carbonation is a long process. The accelerated carbonation test is described in  
328 section 2.2.1.a. An empirical relationship between natural carbonation rate under reference  
329 conditions  $V_{NAT,0}$  ( $\text{mm} \cdot \text{year}^{-1/2}$ ) and accelerated carbonation rate  $V_{ACC}$  ( $\text{mm} \cdot \text{d}^{-1/2}$ ) could be  
330 determined from the PerfDuB database (equation 5).

331

$$332 \quad V_{NAT,0} = 3.03 V_{ACC} \quad (5)$$

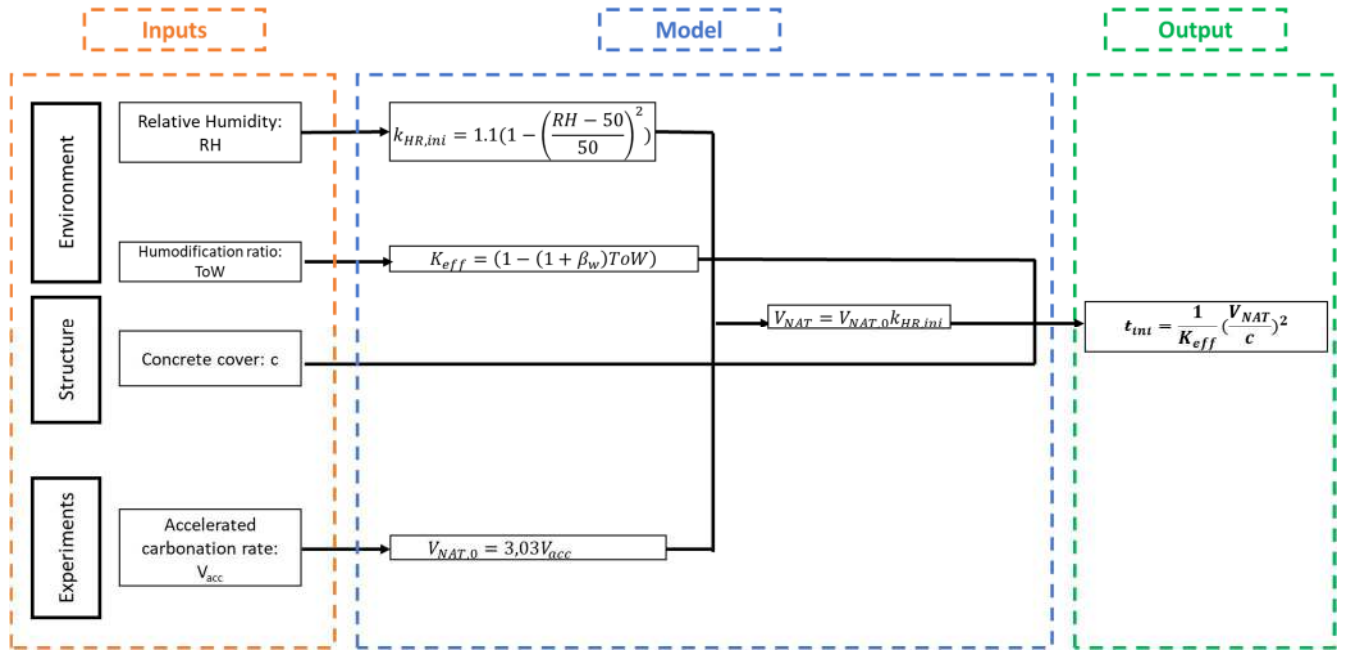

Figure 5: Diagram of the modelling procedure of the initiation period

The influence of ambient relative humidity on the initiation phase is expressed by  $k_{RH,ini}$  (unitless). The carbonation rate is primarily controlled by the kinetics of chemical reactions at high RH and by the diffusion of  $CO_2$  at low RH. Carbonation is assumed to be controlled by gas diffusion in the model proposed for carbonation. The effect of low RH cannot be taken into consideration with this model since we assume that the carbonation reaction is immediate. However, an empirical function is used to model the influence of RH over the entire range (0 to 100%) in a phenomenological approach (equation 6):

$$k_{RH,ini} = 1.1 \left( 1 - \left( \frac{RH - 50}{50} \right)^2 \right) \quad (6)$$

With RH the ambient relative humidity (%)

It should be noted that this empirical function is maximum at 50% RH, in the literature it has been shown that the RH leading to maximum carbonation rate can reach 60% (Wierig HJ, 1984). The function can be adapted if specific data on this maximum is available.

$t_{eff}$  (year), the effective carbonation time: rain-induced wetting/drying cycles have a significant impact on the progress of carbonation front. When the surface of the material is saturated with rainwater, carbonation stops as the gaseous diffusion of  $CO_2$  is not possible anymore. Then a drying phase is required so that the drying front exceeds  $X_c$ , allowing  $CO_2$

352 diffusion and carbonation to proceed (R.F.M. Bakker, 1993). This slows down the  
353 carbonation process.

354 An effective carbonation time can be calculated based on this observation (equation 7).

355 
$$t_{eff} = t - (t_w + t_d) = (1 - (1 + \beta_w)ToW)t = K_{eff}t \quad (7)$$

356 With

357 
$$K_{eff} = (1 - (1 + \beta_w)ToW) \quad (8)$$

358 Where  $t$  the overall exposure time,  $t_w$  the total wetting time, and  $t_d$  the time it takes for the  
359 "drying front" to reach the carbonation front.

360 We assume that the relationship between  $t_d$  and  $t_w$  is linear to simplify this equation. These  
361 two times spans are actually tied to the same property: water permeability.  $t_d$  could be actually  
362 estimated with a drying model, as done in (Thiery et al., 2012) but this requires numerical  
363 resolution and the determination of water permeability determination which requires both  
364 additional experiments and numerical model (Poyet, 2013). Our objective was to design a  
365 relatively simple analytical model with a limited number of input parameters. This  
366 conservative approach results in the introduction of two parameters: a constant  $\beta_w$ , and the  
367 fraction of rainy days per year  $ToW$  (Time of Wetness). These recent findings originate from a  
368 study conducted by Vu et al. (Huy Vu et al., 2019) on 45 concretes exposed to natural  
369 carbonation over 5 years in various countries, whether shielded or not from the rain.  $\beta_w$  was  
370 found to be at least 1.5 from these data, and this is the value that was kept.

371  $ToW$  depends on the exposure class: for classes XC1 to XC3, it is 0; for class XC4, it was set  
372 equal to 0.05.

373 Thus corrosion will be initiated when the carbonation front will reach the reinforcement front  
374 and therefore  $x_c=c$ ,  $c$  being the concrete cover which is a structural parameter. By inverting  
375 equation 4, we obtain:

376 
$$t_{ini} = \frac{1}{K_{eff}} \left( \frac{c}{V_{Nat}} \right)^2 \quad (9)$$

### 377 3.2. Propagation period

378 The modeling procedure is explained in Figure 6. The electrical resistivity of concrete has a  
379 direct impact on the corrosion process because it depicts the current flow between the anodic  
380 and cathodic regions. The association between electrical resistivity and corrosion rate has

381 been established; for a concrete with a high electrical resistivity, the corrosion current is low,  
 382 and thus corrosion propagation is expected to be slower (Hornbostel et al., 2013).

383

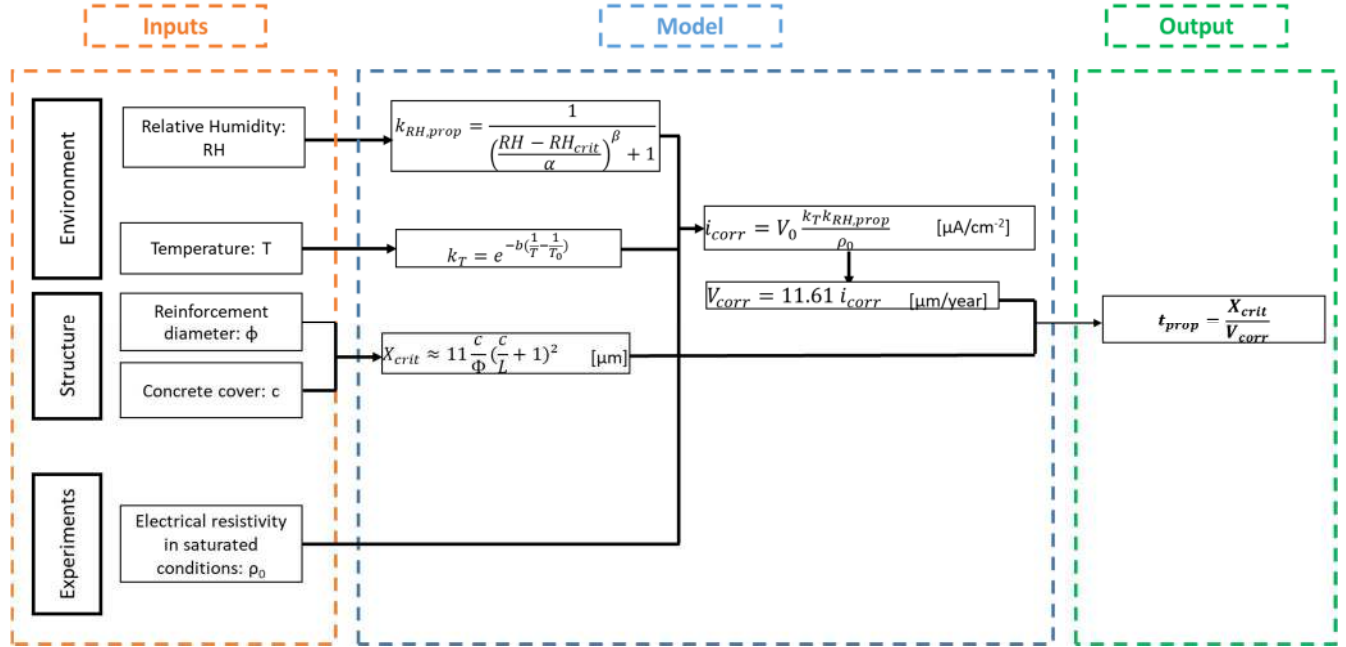

384

385 **Figure 6: Diagram of the modelling procedure of the propagation phase**

386

387 The equation 10 determines the time of corrosion propagation ( $t_{prop}$  - [years]).

388 
$$t_{prop} = \frac{X_{crit}}{V_{corr}} \quad (10)$$

389 where  $X_{crit}$  is the critical diameter loss for a crack opening of 0.1 mm and  $V_{corr}$  the corrosion  
 390 rate.  $X_{crit}$  (m) was first proposed by Torres-Acosta et al (Torres-Acosta and Sagues, 2004) and it  
 391 was calculated as follows: (equation 11).

392 
$$X_{crit} \approx 11 \frac{c}{\Phi} \left( \frac{c}{L} + 1 \right)^2 \quad (11)$$

393 With :

394  $c$  = concrete cover (mm)

395  $\Phi$  = reinforcement diameter (mm)

396  $L$  = length of the anodic zone (mm).

397 Note that the concrete cover  $c$  is the same parameter as used in equation 9. In the case of  
398 carbonation, we consider uniform corrosion and therefore the ratio  $c/L$  is close to 0.

399  $V_{corr}$  can be calculated as a function of the corrosion current density  $i_{corr}$  using equation 12  
400 derived from Faraday's law (valid in the case of uniform corrosion) (François et al., 2018).

$$401 \quad V_{corr} = \frac{\Delta s}{\Delta t} = \frac{M_{Fe}}{\rho_s \cdot F \cdot z_a} i_{corr} = 11.61 i_{corr} \quad (12)$$

402 With  $V_{corr}$  ( $\mu\text{m}/\text{year}$ ) the corrosion rate,  $\Delta s$  (m) the loss in diameter,  $\Delta t$  (s) the duration (s),  
403  $M_{Fe}$  (56 g/mol) the molar mass of iron,  $\rho_s$  [ $\text{g}/\text{m}^3$ ] the density of the steel,  $F$  the Faraday  
404 constant (96500 C),  $z$  the number of electrons exchanged at the anode and  $i_{corr}$  ( $\mu\text{A}/\text{cm}^2$ ) the  
405 corrosion current density.

406 The corrosion current density is determined by an empirical formula obtained from the works  
407 of A. Farissi (Farissi, 2020) based on a bibliographic data analysis (Andrade et al., 1998)  
408 (equation 13).

$$409 \quad i_{corr} = V_0 \frac{k_T \cdot k_{RH,prop}}{\rho_0} \quad (13)$$

410 -  $V_0$  ( $= 168.9 \mu\text{A} \cdot \Omega\text{m} \cdot \text{cm}^{-2}$ ) constant which reflects the corrosion potential, obtained from the  
411 analysis of literature data

412 -  $k_{RH,prop}$  parameter which expresses the influence of RH on the propagation phase.

413 -  $k_T$  parameter which accounts for the influence of the temperature on the propagation phase.

414 -  $\rho_0$  [ $\Omega \cdot \text{m}$ ] the electrical resistivity of concrete in saturated conditions.

415 The temperature effect is taken into account using an Arrhenius law (equation 14) as it was  
416 done in (Jäggi et al., 2007), where  $T$  is the ambient temperature equal to the average annual  
417 temperature for a given environment (K),  $T_0$  the reference temperature (293 K ) and  $b$  is a  
418 regression constant equal to 4220 K.

$$419 \quad k_T = e^{-b\left(\frac{1}{T} - \frac{1}{T_0}\right)} \quad (14)$$

420 For relative humidity, it is considered that the corrosion process in the case of carbonation has  
421 an optimum which corresponds to  $\text{RH}_{crit}$  for which the corrosion current density is maximum.  
422 Given the lack of consensus in the literature on the influence of relative humidity on the  
423 corrosion process and after exploitation of a large number of data from the literature

424 (Bouteiller et al., 2012; Stefanoni et al., 2018), the expression of  $k_{RH,corr}$  was suggested  
425 (equation 15) where

$$426 \quad k_{RH,corr} = \frac{1}{\left(\frac{RH - RH_{crit}}{\alpha}\right)^\beta + 1} \quad (15)$$

427 With:

428 RH: the relative humidity (%)

429 RHcrit: the critical relative humidity which is considered equal to 95%

430  $\alpha$  and  $\beta$  : regression parameters.

431 Note that RH is the same parameter used to calculate  $k_{RH,ini}$  in equation 7. In dry conditions  
432 (RH<60%) the corrosion is limited. It was found in (Stefanoni et al., 2018) that for HR=50%  
433 the corrosion current is actually reduced by a factor of 200. According to the authors, neither  
434 the electrochemistry of the corroding system nor kinetic restrictions resulting from the ohmic  
435 resistivity of the pore system nor restricted oxygen availability explain the substantial  
436 variation in the corrosion rate when changing RH but rather a surface effect which results  
437 from the wetting of the steel surface depending on the relative humidity in the concrete pore  
438 system. To take this effect into account, the parameters  $\alpha$  and  $\beta$  are defined as follows:

$$439 \quad \begin{array}{lll} HR \geq 60\% & \alpha = 6, & \beta = 2 \\ HR < 60\% & \alpha = 21, & \beta = 7 \end{array}$$

## 440 **4- Results and discussion**

### 441 **4.1. Carbonation and its effects on microstructure**

442 The carbonation of concrete is a physico-chemical process in which three mechanisms  
443 intervene:

- 444 - The diffusion of CO<sub>2</sub> inside the concrete, which depends on the transport properties,
- 445 - The dissolution of CO<sub>2</sub> and hydration products and their diffusion in the pore solution,
- 446 - The chemical reaction that produces calcium carbonates.

447 These mechanisms are summarized in the simplified Papadakis model (V. G. Papadakis et al.,  
448 1991) that allows, for a case of unidirectional diffusion of CO<sub>2</sub>, to describe the progress of the  
449 carbonation front (equation 16):

450 
$$x_c = \sqrt{\frac{2De_{CO_2}[CO_2]_0}{[CaO]_0}} \sqrt{t} \quad (16)$$

451 Where:

452  $x_c$ : the carbonation front (mm)

453  $De_{CO_2}$ : Effective diffusivity of CO<sub>2</sub> in carbonated concrete (m<sup>2</sup>/s)

454  $[CO_2]_0$ : The molar concentration of CO<sub>2</sub> per unit volume of the gas phase (mol/m<sup>3</sup>)

455  $[CaO]_0$ : The total molar concentration of carbonatable CaO (mol/m<sup>3</sup>)

456 They are concomitant and the carbonation resistance of a material depends on both its  
 457 physical and chemical properties. In this section the carbonation rate of the studied concretes  
 458 is analyzed in the light of these properties.

459 Figure 7 shows the progress of the carbonation front of concretes II, III, C1 and C3 as a  
 460 function of the square root of time. As a diffusive phenomenon, carbonation can be modeled  
 461 by Fick's law. Under simplifying assumptions (V. Papadakis et al., 1991), the solution can be  
 462 expressed in the form of equation 17:

463 
$$x_c(t) = V_{ACC} \sqrt{t} \quad (17)$$

464 The curves were approximated by a linear curve. The R<sup>2</sup> of the four regressions were higher  
 465 than 0.98. The table 6 summarizes the slopes of the curves that represent the accelerated  
 466 carbonation rate of each concrete.

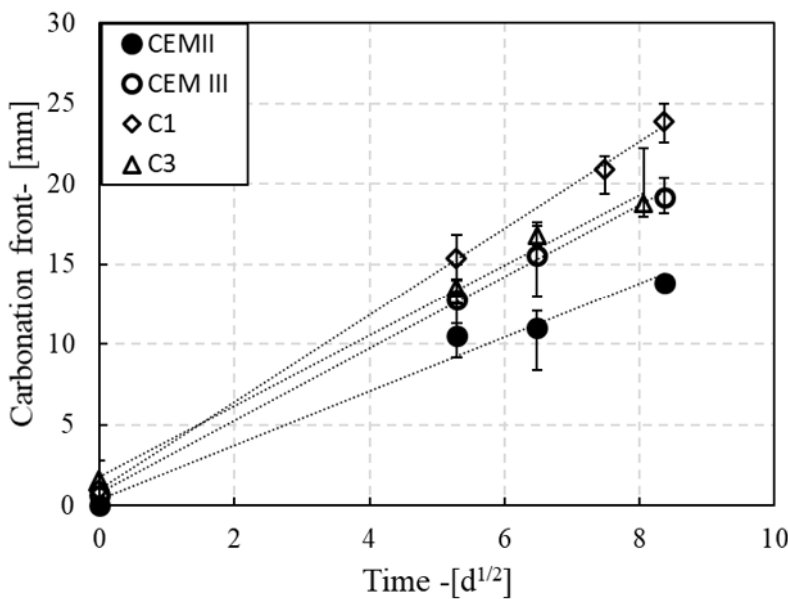

**Table 6: Accelerated carbonation rates of the studied concretes**

Concrete	$V_{ACC}$ (mm.t <sup>-1/2</sup> )
CEM II	1.67
CEM III	2.23
C1	2.70
C3	2.19

467 **Figure 7: Accelerated carbonation depths of the studied concretes at 0, 28, 42 and 70 days**

468 CEM II had the highest clinker content and it exhibited the highest carbonation resistance, C1  
469 the lowest, and CEM III and C3 had approximately equal rates. A comparison between CEM  
470 III and C1, which have the same clinker content, reveals the negative effect of limestone on  
471 the carbonation resistance of the cement. The low carbonation rate observed for CEM II can  
472 be ascribed to his high clinker content, which results in higher content of carbonatable  
473 material thus higher carbonation resistance. This result is consistent with the findings of  
474 (Bolte et al., 2019) for the case of Clinker-Slag-Limestone ternary systems and (Medjigbodo  
475 et al., 2018) for Clinker-Metakaolin-Limestone systems.

476 From these data, the carbonation resistance of the studied concretes cannot be simply  
477 correlated with cement composition. As previously stated, the resistance to carbonation  
478 influences the initiation time of corrosion and, under specific RH conditions, the SL of  
479 concrete cover. The influence of microstructural properties and cement composition will be  
480 discussed from the experimental results in the following sections. Two microstructural  
481 variables may be relevant to investigate in order to understand concretes carbonation results:  
482 the chemistry of the microstructure and the PSD, which influences transport properties. We  
483 will first attempt to link carbonation resistance to microstructural features, then establish a  
484 link between cement composition and the microstructure of cementitious matrix.

#### 485 a- Influence of the chemical parameters

486 CH content before carbonation and after 42 days of carbonation are shown in figure 8. The  
487 initial CH content of the various binders varies according to their initial composition; it  
488 depends on their clinker content and hydration reactions. After carbonation, the amount of CH  
489 consumed varied depending on cement paste initial composition. It was almost entirely  
490 consumed for cements with a low clinker content i.e. C1 and CEM III but significant CH  
491 content was observed for CEM II after carbonation.

492 To qualify the hydration products affected by carbonation as well as the carbonation products,  
493 XRD analyzes were carried out on C1 cement paste before and after carbonation; the results  
494 are shown in figure 9. Before carbonation, significant peaks of ettringite and carboaluminates  
495 can be observed. This is due to the presence of calcium carbonates which favors the  
496 stabilization of ettringite and hinders AFm formation (Adu-Amankwah et al., 2017). The peak  
497 of hemicarboaluminates is preponderant compared to monocarboaluminates. At high  
498 carbonate to aluminate ratios, the most stable form of the carboaluminates is

499 monocarboaluminate (Lothenbach, 2010), and this reaction consumes the portlandite and the  
500 calcite present in the limestone (Antoni et al., 2012).

501 After carbonation, TGA show that the portlandite is partially consumed for all the cement  
502 pastes, this observation is validated by XRD analysis on C1 (figure 9 –b). C-S-H being an  
503 amorphous phase, its presence is detected by a large bump around  $2\theta=30^\circ$ . This bump  
504 flattened after carbonation, which indicates C-S-H carbonation. This reaction results in the  
505 formation of vaterite which is detected in carbonated cement paste spectrum (Morandeu et  
506 al., 2014). Ettringite was also partially consumed by carbonation. This reaction releases water  
507 and leads to the formation of aragonite (Nishikawa et al., 1992). Furthermore, there is a  
508 significant reduction in the amplitude of the hemicarboaluminate peak, this may be due either  
509 to their carbonation or to their transformation into monocarboaluminates given the formation  
510 of calcium carbonates resulting from the carbonation of portlandite and other hydrated phases.

511 Several authors have shown the influence of the initial CH content on the resistance to  
512 carbonation (Bucher et al., 2017). CH actually has a buffering effect which allows  
513 maintaining a high pH and promotes reinforcements depassivation. Shi et al (Shi et al., 2016)  
514 claim that the pH drop after carbonation is not only due to CH carbonation but also to C-S-H  
515 carbonation, especially high-Ca C-S-H. Since three studied binders are rich in GGBS, CH is  
516 consumed by GGBS hydration to form C-(A)-S-H. The model proposed by Papadakis  
517 (equation 16) actually states that the resistance to carbonation reflected by the carbonation  
518 front depends on the carbonatable products which include the C-S-H, ettringite,  
519 carboaluminates and other hydration products as well as some anhydrous phases (Shi et al.,  
520 2016). Figure 10 actually shows a inverse relationship ( $R^2=0.97$ ) between the carbonation rate  
521 and all the hydrates formed which can be quantified from TGA by  $BW_{40-550}$ .

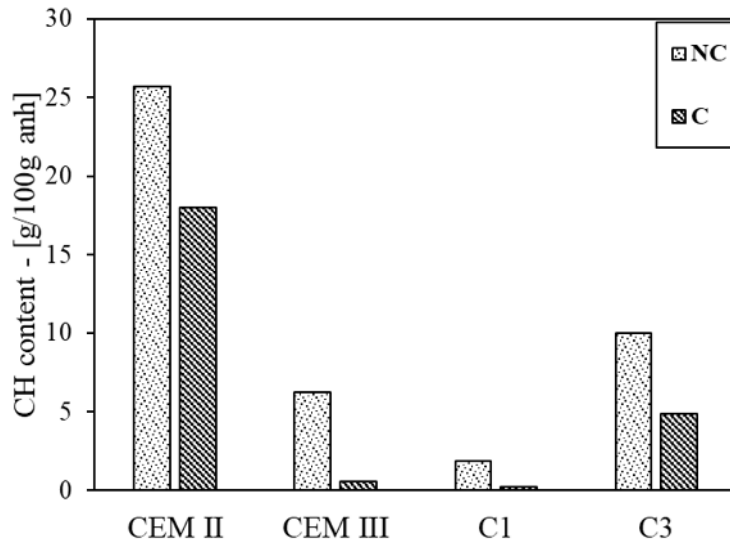

522

523 **Figure 8: Portlandite and bound water (BW<sub>40-400°C</sub>) content of carbonated and non carbonated**  
 524 **cement pastes. NC is for non carbonated and C is for carbonated cement paste**

525

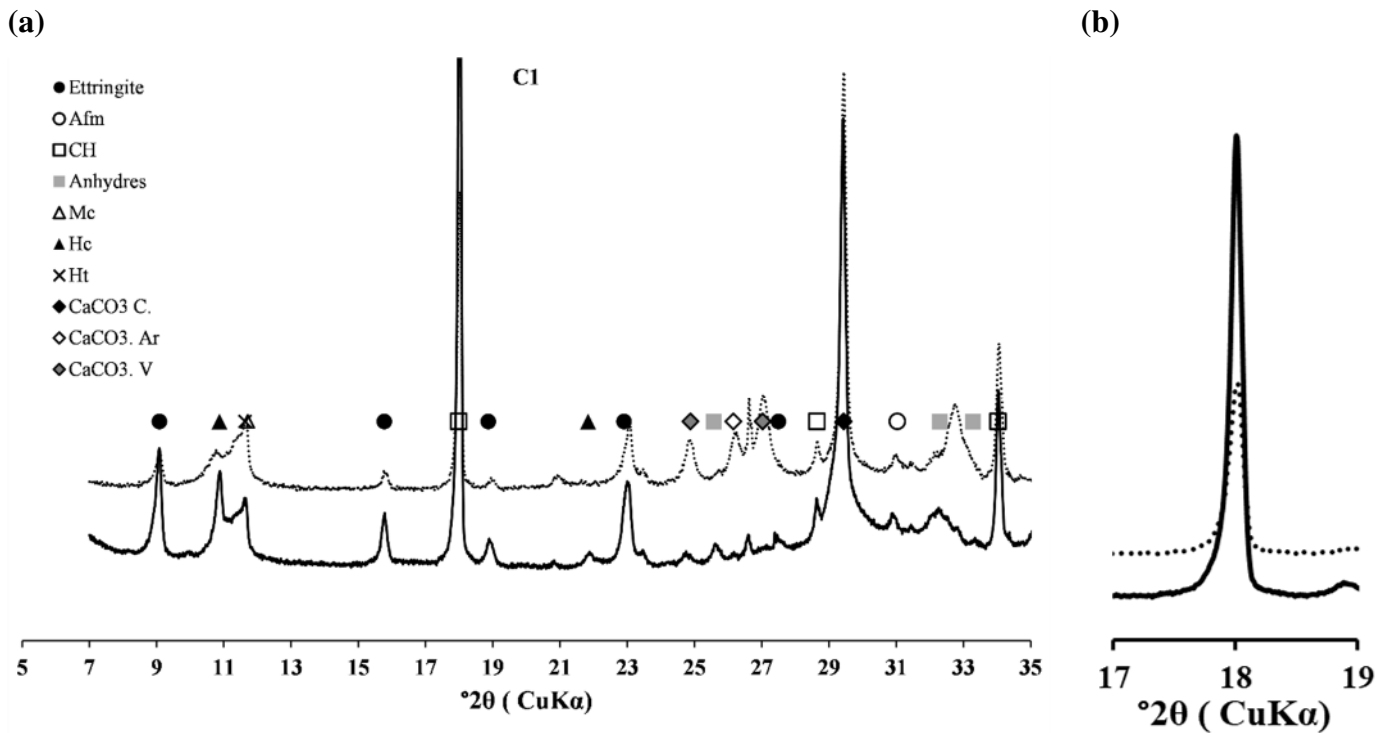

526 **Figure 9: (a) Influence of the carbonation on the microstructure of C1 cement paste (b)**  
 527 **Portlandite peak before and after carbonation. Solid line for non carbonated, and dashed line**  
 528 **for carbonated cement paste. AFm: monosulfoaluminate, CH: portlandite, Mc: monocarbonate,**  
 529 **Hc: Hemicarbonate, Ht: hydrotalcite, CaCO<sub>3</sub> C: calcite, Ar: aragonite, V: vaterite**

530

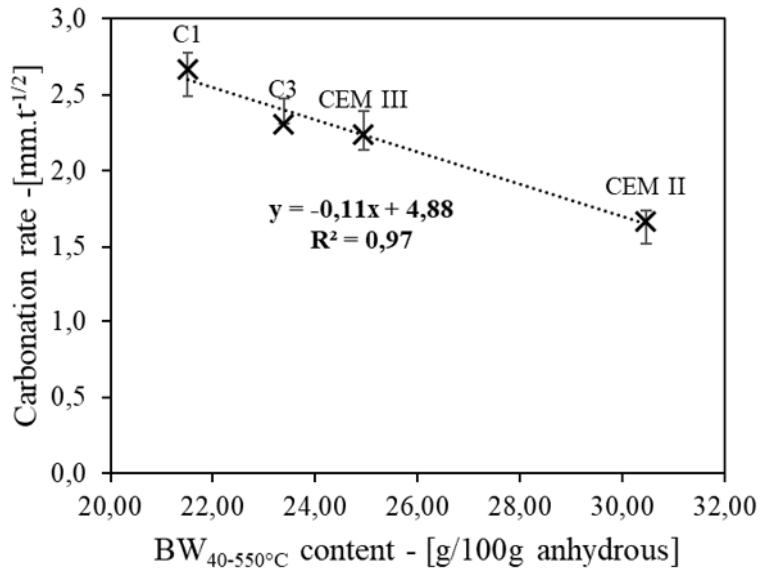

531

532 **Figure 10: Influence of total bound water on the carbonation rates of studied concretes**

533

534 b- Influence of the physical parameters

535 The PSD of carbonated and non-carbonated concrete cubes in figure 11 show that before

536 carbonation, the critical pore size decreased when increasing GGBS fraction.

(a)

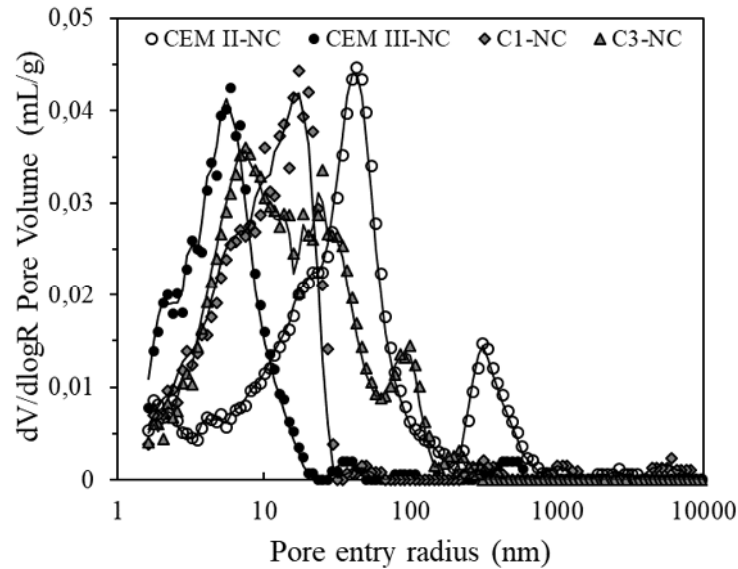

(b)

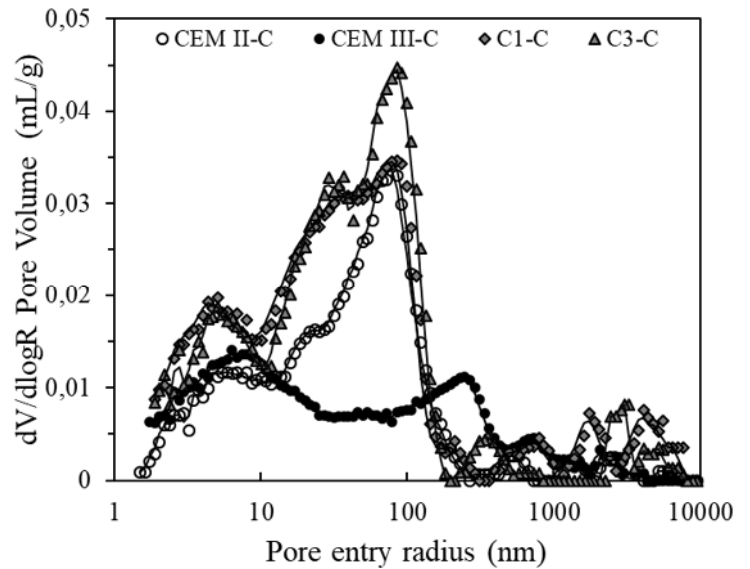

537 **Figure 11: Differential pore size distribution of (a) non carbonated (NC) and (b) carbonated (C)**  
 538 **concrete cubes**

539

540 The same trend has already been reported in [28]. After carbonation, the peaks are  
 541 approximately at the same pore size, which is around 80nm except for CEM III which present  
 542 two peaks, at 6 and 250nm. As shown in figure 8 CEM III cement paste actually had low CH  
 543 content at later age and given its mineralogical composition, it had lower calcium to silicate  
 544 (C/S) ratio than CEM I. These conditions allow: 1- C-S-H carbonation which leads to silica  
 545 gel formation and therefore coarsens the microstructure (Gruyaert et al., 2013), and 2-  
 546 ettringite carbonation which releases a lot of water (Nishikawa et al., 1992). In order to  
 547 understand the effect of the carbonation of hydrates such as CH on the evolution of the pore  
 548 size, the difference in the threshold radius before and after the carbonation has been plotted as  
 549 a function of the quantity of carbonated CH expressed as the difference between the CH  
 550 content before and after carbonation (cf figure 12).

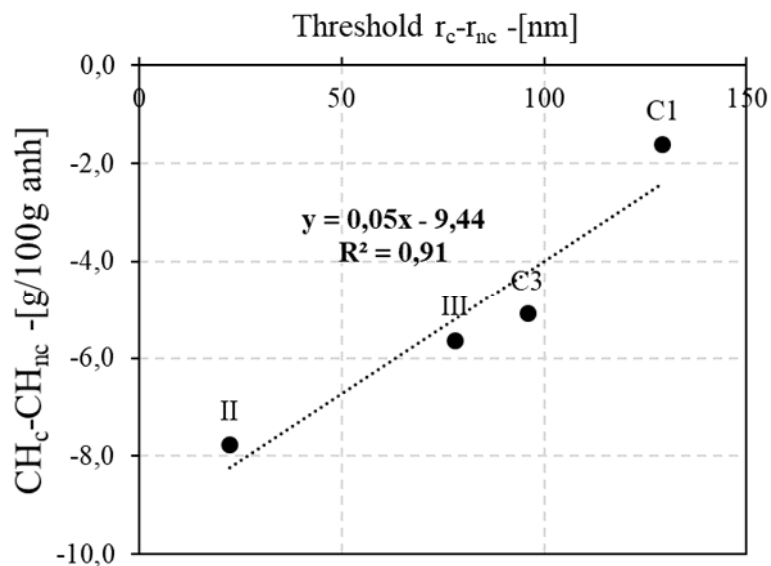

551

552 **Figure 12: Correlation between the change in threshold pore size before and after carbonation**  
 553 **and the portlandite content consumed by carbonation.  $r_c$  and  $r_{nc}$  represent radii of carbonated**  
 554 **and non carbonated samples respectively.**

555

556 Irrespective of the amount of CH consumed by carbonation, the difference in pore size before  
 557 and after carbonation is positive. For CEM II, this difference is very small ( $<0.05\mu\text{m}$ ).  
 558 Furthermore, the higher the increase in the size of the pore radii, the lower the CH consumed  
 559 by carbonation was, this suggests that it is not the carbonation of CH that is responsible for  
 560 this increase in pore size, but rather the other hydrates. For the other cements, there was a  
 561 higher coarsening of the pores, this can be explained by two factors: 1- The carbonation of C-  
 562 (A)-S-H which produces silica gel and less stable polymorphs of calcium carbonates and

563 ettringite which releases a lot of water, 2- Carbonation shrinkage that occurs at the level of the  
564 pores. In fact, the latter results in decalcification and polymerization of C-S-H followed by  
565 formation of amorphous silica (Kangni-Foli et al., 2021). For ternary cements for whom little  
566 CH is available for carbonation, the PSD is negatively influenced. A similar result was  
567 observed in (Shah et al., 2018) for cement pastes made of clinker, metakaolin which has a  
568 pozzolanic activity, and limestone. This confirms the observations of Kangni-Foli et al.  
569 (Kangni-Foli et al., 2021) who found that carbonation of C-S-H leads to pore size coarsening.  
570 It was also found in the same study that the carbonation shrinkage of C-S-H pastes is more  
571 pronounced than that of  $C_3S$  paste and CH, this may further coarsen even more the  
572 microstructure. The authors also concluded that the lower carbonation resistance of some  
573 blended cement pastes was due to an increase in  $CO_2$  diffusion coefficient induced by  
574 microcracking.

575 Ettringite crystals tend to grow in a direction that is less constrained by solid pores, such as  
576 into or around the pores rather than within the solid matrix (directed or non-directed). This  
577 crystal development in solid pores can substantially reduce the diameter of micro pores.  
578 Furthermore, after carbonation, ettringite is dehydrated and thus its crystals suffer a  
579 significant change in a and c lattice parameters, resulting in a decrease in crystal volume  
580 (Chen et al., 2019). As a result, the size and volume of pores containing ettringite might be  
581 increased.

582 In response to the first question concerning the link between the composition of cement and  
583 its resistance to carbonation, a good correlation was found between the rate of accelerated  
584 carbonation and the total bound water content of cements (figure 10). Calcium is present in  
585 almost all the hydrated phases and it mainly comes from the initial CaO present in the cement  
586 and GGBS. In (Shah et al., 2018) the author assumes that only the CaO contained in the  
587 clinker is able to bind  $CO_2$ . In our study, the active CaO content was calculated as the sum of  
588 the CaO contained in the clinker and the GGBS, as the GGBS has latent hydraulic properties  
589 which are activated by the hydration of the clinker (Roy and Idorn, 1982). Figure 13 shows a  
590 good correlation between the initial content of active CaO and the bound water content of  
591 long-term hydrated cement paste, which provides information on the  $CO_2$  binding capacity of  
592 binary and ternary cements.

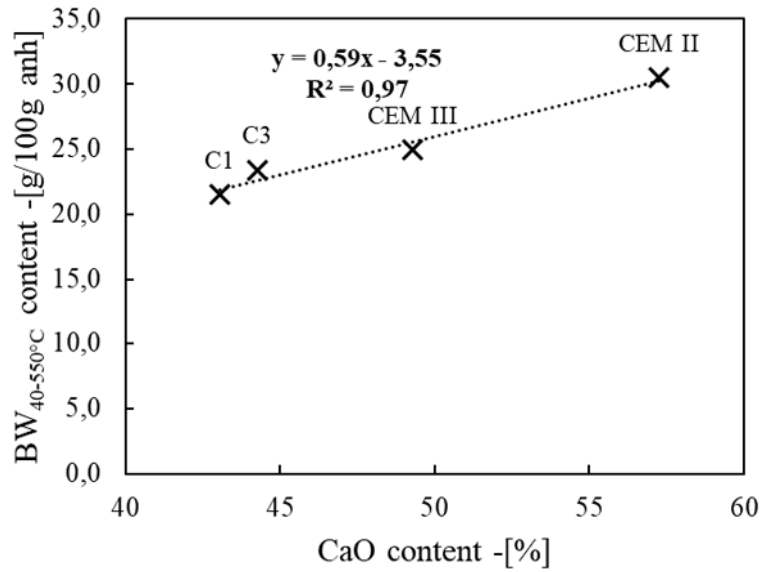

593

594 **Figure 13: Correlation between total bound water content of mature cement pastes and initial**  
 595 **reactive CaO content**

596

~~598~~

600

#### 4.2. Electrical resistivity

601 To standardize the results, the resistivity value retained for each sample corresponds to the  
 602 slice closest to the center of the cubic sample. The figure 14-a shows the resistivity values  
 603 plotted as a function of the threshold pore radius. CEM III and C1 had the same clinker  
 604 content, and their values of electrical resistivity were very close, the difference could not be  
 605 significant since the error bars overlap. In general, limestone does not have the same  
 606 refinement effect on the microstructure as GGBS. A high clinker replacement by limestone  
 607 has been reported to result in increased porosity in (Palm et al., 2016). Moreover, the pore  
 608 solution composition has also an effect on concrete resistivity. It has been found that the  
 609 cements containing pouzzolanic MAs are characterized by a lower alkalinity, since the alkali  
 610 are bound in the C-S-H (Vollpracht et al., 2016). This results in high resistivity values, as  
 611 observed in Chopperla et al. (Chopperla and Ideker, 2022) for the case of GGBS cement-  
 612 based materials. Since limestone has a long-term diluting effect (Mounanga et al., 2011), its  
 613 alkalinity-reducing effect may be insignificant.

614 The plot of electrical resistivity versus the threshold pore entry radius shown in figure 14-a  
 615 reveals an exponential relationship and figure 14-b shows a strong correlation between  
 616 threshold pore radius and GGBS content of the cements. This is in accordance with what has

617 been found in (Medeiros-Junior and Lima, 2016). For a given concrete mixture, GGBS  
 618 content of cement appeared as a good indicator of corrosion propagation time as it gives  
 619 information about relative variations of electrical resistivity. However, it has been found that  
 620 the GGBS source may strongly influence the electrical resistivity (van Noort et al., 2016).  
 621 Otieno et al, (Otieno et al., 2014) have also found that the oxydes composition of slag  
 622 negatively influences the chloride penetration resistance of concrete since it affects the  
 623 refinement of concrete microstructure. Thus, since there is a correlation between chloride  
 624 diffusion coefficient and electrical resistivity (Chidiac and Shafikhani, 2020) this confirms the  
 625 findings of (Van Noort et al., 2016).

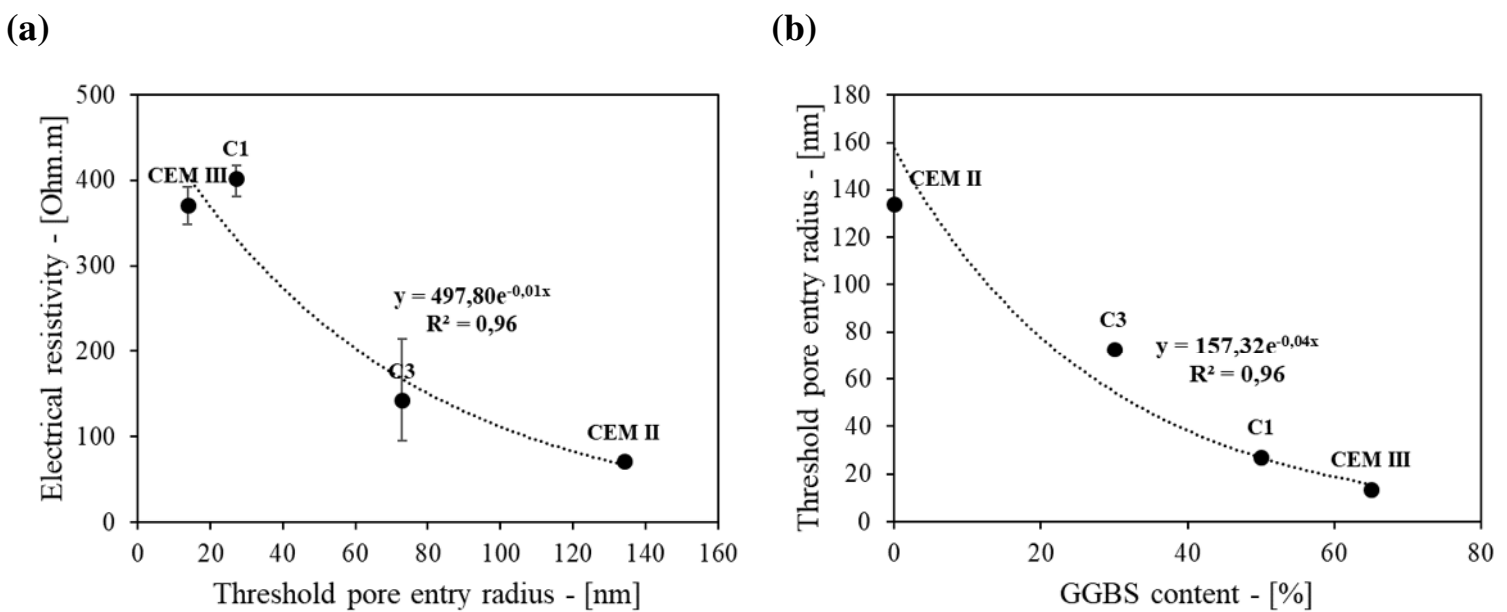

626 **Figure 14: Correlation between (a) electrical resistivity and threshold pore radius and (b)**  
 627 **threshold pore radius and GGBS content of the studied concretes**

628

### 629 4.3. Service life prediction

630 The service life values given in this section correspond to the sum of initiation and  
 631 propagation times of carbonation-induced corrosion. The prediction model is used to assess  
 632 the influence of the main material properties used to characterize each process, respectively  
 633 accelerated carbonation resistance and resistivity, on the total service life. The environmental  
 634 conditions correspond to the XC exposure classes. The 4 subclasses XC1-XC4 are defined  
 635 depending on the specific RH and rain conditions. The effects of temperature and curing  
 636 conditions are out of the scope of this study. Table 7 describes the input data of RH and ToW  
 637 (Time of Wetness i.e. the fraction of annual rainy days) for the 4 exposure classes. The cover

638 values taken for each exposure class are those recommended by Eurocode 2 for buildings and  
 639 SL of 50 years. These values correspond to the minimum cover value ( $c_{min}$ ) required by this  
 640 standard, but in reality, an allowance in design for deviation ( $\Delta c_{dev}$ ) of 10mm is applied for  
 641 cast-in-situ concrete, it is mentioned in the reinforcement design to take into account the  
 642 possible movements of the reinforcements in the formwork at the time of implementation, the  
 643 sum of the minimum cover value and the allowance in design for deviation is the nominal  
 644 cover ( $c_{nom} = c_{min} + \Delta c_{dev}$ ). The reinforcements diameter has been set at 20mm, which is a  
 645 common value in construction projects.

646

647 **Table 7: Environmental conditions described by XC exposure class and minimum concrete**  
 648 **cover recommended for each class in Eurocode 2**

	<b>RH (%)</b>	<b>ToW (-)</b>	<b>Minimum cover <math>c_{min}</math> (mm)</b>
<b>XC1</b>	50	0	15
<b>XC2</b>	90	0	25
<b>XC3</b>	75	0	25
<b>XC4</b>	65	0.05	30

649

650 The isolines of concrete cover SL are shown in figure 15. The duration presented is the sum  
 651 of the corrosion initiation and propagation times ( $t_{SL} = t_{ini} + t_{prop}$ ). The experimental results were  
 652 used to predict the SL of the studied concretes for the different exposure classes. CEM III and  
 653 CEM II are denoted in the graph by “III” and “II” respectively. It is noteworthy that the  
 654 studied concrete mixtures comply with the requirements of standard EN 206 for an exposure  
 655 class XC3/XC4 with regard to the minimum cement content and the maximum W/C ratio, and  
 656 consequently they also comply with XC1 and XC2 classes which are less demanding. In  
 657 addition, the mixture proportions and constituents of studied concretes were close to the  
 658 concretes of the database of PerfDuB project concretes, which was used to establish the  
 659 empirical laws of the model.

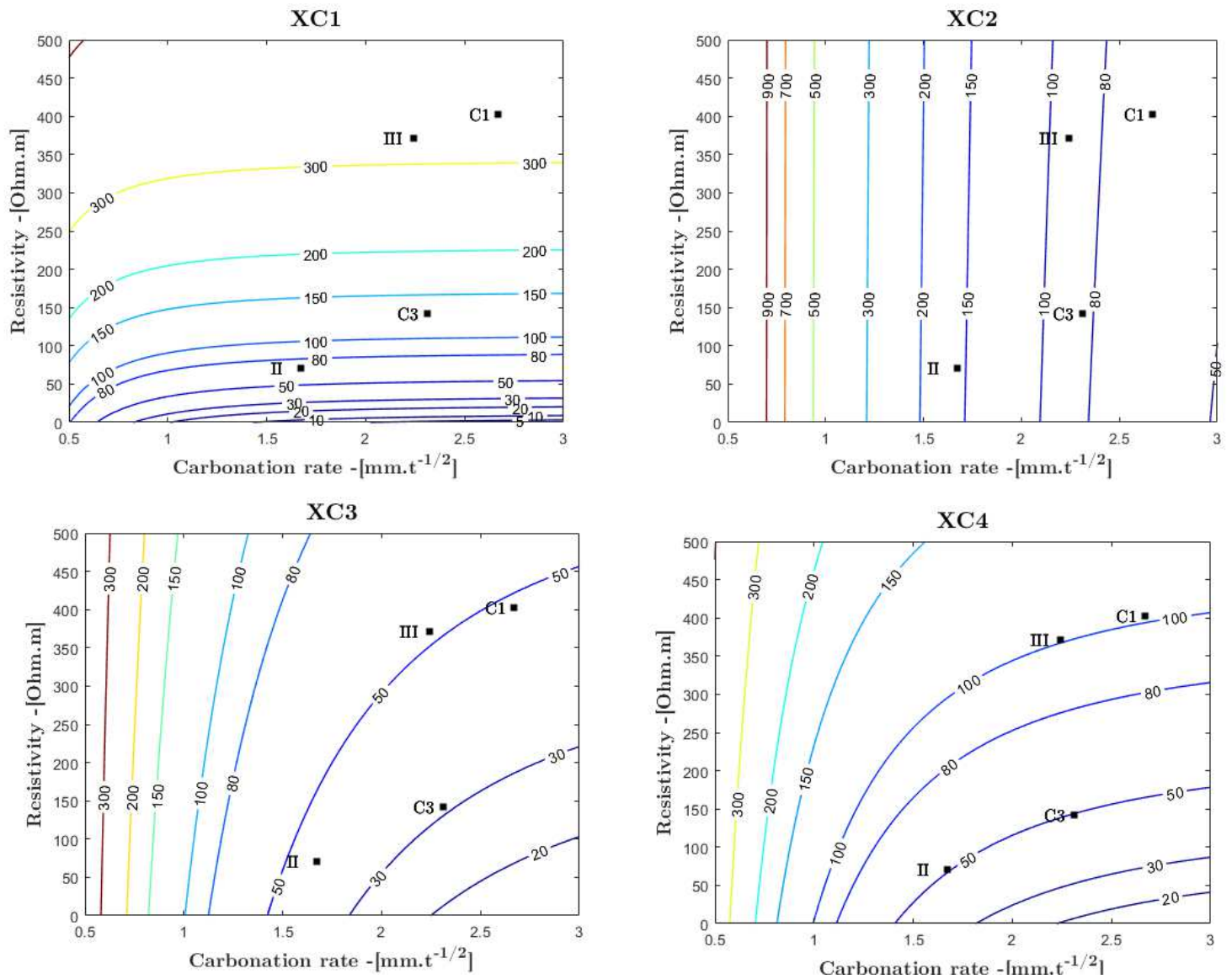

660 **Figure 15: Service life duration isolines in years predicted by the model for XC exposure classes**

661

662 The results of the sensitivity study on the cover value (Figure 16) show that for the most  
 663 demanding classes, namely XC3 and XC4, taking into account the safety margin clearly  
 664 improves the service life of the concrete cover and makes it possible to reach the target  
 665 lifetime for the structural class considered for all the concretes studied.

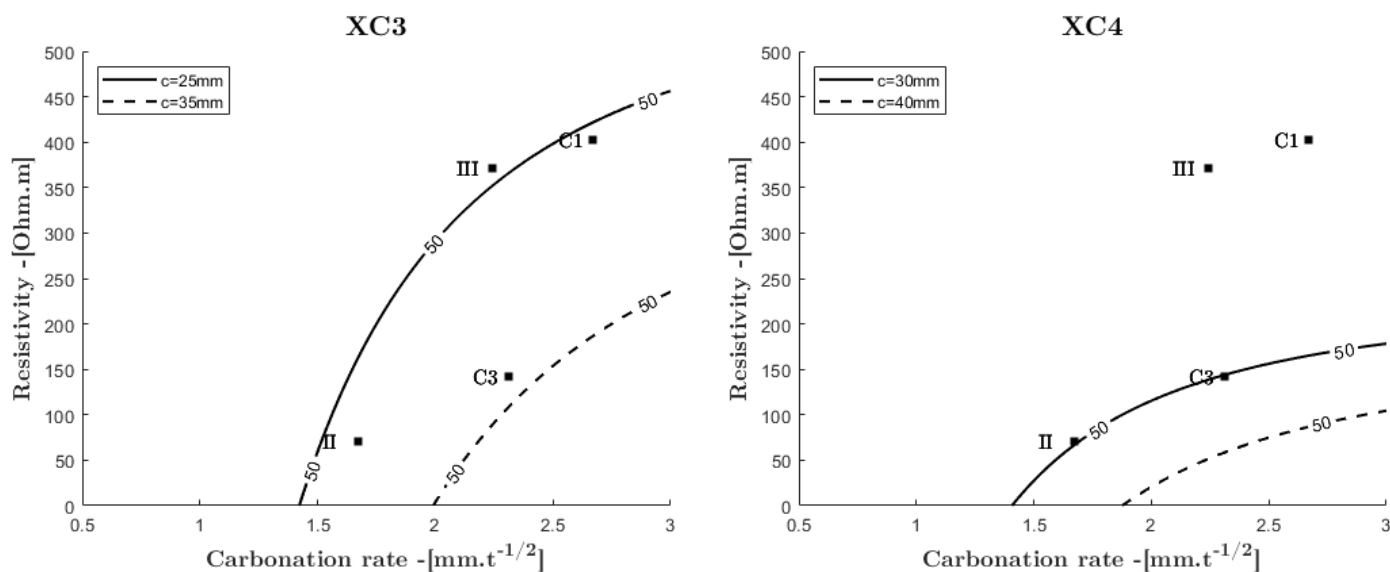

666 **Figure 16: Sensitivity study of the concrete cover depth value for 50 years service life: minium**  
 667 **cover  $c_{min}$  (solid lines) and nominal cover  $c_{nom}$  (dotted lines)**

668 For XC1, the model predicts very long service lives and the iso-SL curves are almost parallel  
 669 to the abscissa axis. Since the resistivity is much lower, the propagation time is much higher  
 670 than the initiation time which becomes almost negligible ( $t_{SL} \approx t_{prop}$ ). For all the studied  
 671 concretes, the model predictions exceed 150 years, which is beyond the target SL for  
 672 buildings (50 years). This reflects the relatively low corrosion risk in XC1 environments.

673 For XC2 class, the curves are almost parallel to the y-axis and slightly inclined. Considering  
 674 the environmental conditions for this class (wet and very rarely dry), the corrosion is  
 675 enhanced. Therefore, the time of propagation of corrosion is negligible compared to that of  
 676 initiation ( $t_{SL} \sim t_{ini}$ ). Hence, the carbonation rate has a key role for this exposure class. In  
 677 general, all the studied concrete covers have a SL duration of more than 50 years. High RH  
 678 actually results in low carbonation rate.

679 For XC3 and XC4, the plots tend to be curved as the SL decreases; for concretes with low  
 680 carbonation resistance, a high electrical resistivity significantly contributes to improving their  
 681 SL, as is the case for C1 and CEM III (denoted III on the graph), which have a resistivity of  
 682 the order of 400 Ohm.m. The curvature of the plots reflects the dominance of one phase over  
 683 the other. For the domain of  $\rho$  and  $V_{ACC}$  presented in the graphs, the isolines begin to stabilize  
 684 from  $V_{ACC} = 1.25$  for a SL of 50 years (in XC3), for the XC4 this can be observed for a  $V_{acc}$   
 685  $< 1 \text{ mm.d}^{-1/2}$  for a SL of 100 year life.

686 From the results above, if the corrosion propagation time is taken into account, concretes  
 687 made with ternary cements and relatively low resistance to carbonation can under certain

688 environmental conditions lead to more durable structures, as is the case for C1 for a XC1,  
 689 XC3 and XC4 classes.

690 4.4. CO<sub>2</sub> efficiency indicator (CO<sub>2</sub>/Service Life)

691 In order to assess the environmental impact of these new cements, a calculation of CO<sub>2</sub>  
 692 emissions was carried out. This calculation is based on the emission factors of the various  
 693 constituents (clinker, GGBS, limestone) collected from LCA analyses and environmental  
 694 product declaration (EPD)(AFNOR, 2014). The clinker data were provided by French  
 695 Technical Association of Hydraulic Binders (ATILH) for the year 2017. Emission factors for  
 696 each component are given in table 8. It is noteworthy to mention that the clinker emission  
 697 factors are not universal, but rather based on specific production process used in France. This  
 698 value could vary, for example, if clinker was produced using either fossil fuels or nuclear  
 699 energy as energy sources.

700 **Table 8: CO<sub>2</sub> emission factors used for the environmental analysis**

	<b>Emission factor (kg CO<sub>2</sub>/kg)</b>		<b>Reference</b>
<b>Clinker</b>	0.881		(ATILH, 2017)
<b>GGBS</b>	with allocation <sup>(*)</sup>	0.114	(Chen et al., 2010)
	without allocation	0.085	(Miller, 2018)
<b>Limestone</b>	0.0278		(Proske et al., 2018)
<b>Sand</b>	0.0026		(Bolte et al., 2019)
<b>Gravels</b>	0.0075		(Wang and Lee, 2019)
<b>Superplasticizer</b>	0.767		(Miller, 2018)

701 <sup>(\*)</sup> Economic allocation

702 These data were used to calculate the carbon emission of one cubic meter of concrete for each  
 703 cement studied. This emission was reported to the SL of the concrete cover predicted by the  
 704 model. This ratio, which is noted CO<sub>2</sub> efficiency indicator (CEI) is a more effective indicator  
 705 of the environmental impact of these cements since it provides information on the carbon cost  
 706 of one year of service of the concrete cover, which is proposed as a more representative  
 707 functional unit for the use of cement. Figure 17 shows the emission factors of the four studied  
 708 cements as well as their CEI for the composition of the concrete studied for exposure classes  
 709 XC1-XC4. The values presented are calculated for an average GGBS emission factor. The

710 error bars reflect whether or not the carbon allocation of the GGBS has been taken into  
 711 account.

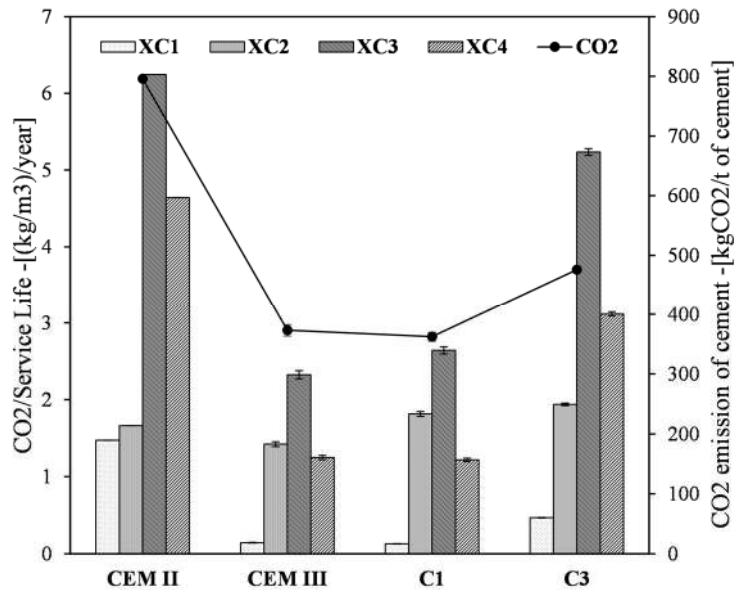

712

713 **Figure 17: CO<sub>2</sub> emission factor and effective global warming potential (CEI) of the cements**  
 714 **studied for XC1-XC4 exposure classes**

715

716 A low CEI indicates a lower contribution of concrete production and use to climate change.  
 717 CEM II, having a relatively high carbon footprint, has a relatively high CEI compared to other  
 718 cements for almost all exposure classes except XC2 for which the initiation time prevails.  
 719 CEM III, on the other hand, has a low CEI because there is a good compromise between his  
 720 CO<sub>2</sub> emission and durability material properties. C1 show low CEI as well, in addition, this  
 721 has the advantage of containing limestone, which is a natural resource that replace GGBS.  
 722 GGBS is a more interesting MA since it is reactive in the long term (Giergiczny, 2019).  
 723 Nevertheless, its carbon allocation is still questioned (Chen et al., 2010). GGBS is an  
 724 industrial by-product and cannot be considered as waste since its production requires an  
 725 investment to install granulators in iron manufacturing plants (Scrivener et al., 2018), in  
 726 addition to the grinding, drying and filtration process necessary to make the product suitable  
 727 for use in cement. Thus, depending on the carbon allocation of the GGBS, the CEI of these  
 728 cements will evolve. Moreover, the importance of using GGBS efficiently given its limited  
 729 availability has been highlighted in the study by Proske et al. (Proske et al., 2018) by  
 730 introducing a “slag efficiency factor” into their analysis. Moreover, the difference in CEI is  
 731 not very significant in the case of this study since the difference in the emission factor of the  
 732 GGBS with and without allowance is not very large (table 8). Note that the allocation

733 considered is economic; the error bars for GGBS-containing cements could have been larger  
734 if another allocation type had been taken into account. Finally, the use of limestone presents  
735 an interesting prospect for partially replacing the GGBS in a ternary cement. Its  
736 environmental contribution is very low, and the results obtained show that, for a suitable  
737 concrete mixture, the material properties are good for an acceptable SL, on the other hand.

## 738 **5- Conclusion**

739 This paper is focused on the durability performance of concrete made with the ternary  
740 cements of the new European standard EN 197-5 relatively to their environmental impact. A  
741 new characterization of so-called “low-carbon cements” is proposed based on the CO<sub>2</sub>  
742 emission/service life of the concrete cover under carbonation induced corrosion which takes  
743 into account the propagation time as well as the initiation time. An experimental study aimed  
744 at determining the durability parameters of several concretes based on binary and ternary  
745 cements was carried out. An empirical model that takes into account both the initiation and  
746 propagation phases of corrosion process was used to predict the service life of the cover of the  
747 concretes studied from material properties. The findings of this study can be summed up as  
748 follows:

- 749 1- All the hydration products formed seem to contribute to the carbonation resistance of  
750 concretes
- 751 2- The initial reactive CaO content of cements, which comes from clinker and slag,  
752 provides information on the amount of water bound in the long term and thus it could  
753 be an indicator of the carbonation resistance for a given concrete mixture depending  
754 on the cement used.
- 755 3- The slag, by its positive influence on the refinement of the porosity, seems to have a  
756 significant effect on the extension of the corrosion propagation time as it contributes  
757 to the improvement of the electrical resistivity
- 758 4- The model used shows that the propagation duration can predominate over the  
759 initiation duration, especially under low relative humidity conditions, such as the  
760 environment described in the XC1 exposure class.
- 761 5- The new ternary binders seem to have a low CO<sub>2</sub> efficiency indicator (CEI) coefficient  
762 given their low carbon emission and acceptable service life. The combination of  
763 clinker, slag and limestone offer new possibilities in reducing the CO<sub>2</sub> emissions of  
764 building materials while meeting the required durability.

765 Finally, since resistivity depends on the pore size and pore solution, it is interesting to explore  
766 the evolution of the resistivity of concrete due to carbonation, as carbonation induces  
767 modifications on those properties. This will allow a more precise and realistic prediction  
768 given the chronology of the facts: the propagation of corrosion follows its initiation. Further  
769 research would be necessary to draw clear conclusions on this issue.

## 770 **CRedit authorship contribution statement**

771 Imane Elkhaldi: Writing – original draft, Investigation, Visualization, Formal analysis  
772 Emmanuel Roziere: Conceptualization, Methodology, Writing – review & editing,  
773 Supervision  
774 Philippe Turcry: Conceptualization, Writing – review & editing,  
775 Ahmed Loukili: Conceptualization, Supervision, Funding acquisition, Project administration

## 776 **Declaration of competing interest**

777 The authors declare that they have no known competing financial interests or personal  
778 relationships that could have appeared to influence the work reported in this paper.

## 779 **Acknowledgements**

780 The authors would like to thank EDYCEM company and Ecole Centrale de Nantes for their  
781 financial support and ATILH (Association Technique de l'Industrie des Liants Hydrauliques –  
782 French Technical Association of the Industry of Hydraulic Binders) for fruitful discussions.  
783 Geraldine Villain from University Gustave Eiffel is also gratefully acknowledged for her  
784 support in performing the resistivity tests.

## 785 **References**

- 786 Aboulayt, A., Jaafri, R., Samouh, H., Cherki El Idrissi, A., Roziere, E., Moussa, R., Loukili,  
787 A., 2018. Stability of a new geopolymer grout: Rheological and mechanical  
788 performances of metakaolin-fly ash binary mixtures. *Constr. Build. Mater.* 181, 420–  
789 436. <https://doi.org/10.1016/j.conbuildmat.2018.06.025>  
790 Adu-Amankwah, S., 2016. Relationship between Microstructure, Durability and Performance  
791 of CEM X Composite Cements - PhD Thesis. The University of Leeds.  
792 Adu-Amankwah, S., Zajac, M., Stabler, C., Lothenbach, B., Black, L., 2017. Influence of  
793 limestone on the hydration of ternary slag cements. *Cem. Concr. Res.* 100, 96–109.  
794 <https://doi.org/10.1016/j.cemconres.2017.05.013>  
795 AFNOR, 2014. NF EN 15804+A1, Sustainability of construction works - Environmental  
796 product declarations - Core rules for the product category of construction products.

797 Alonso, C., Andrade, C., González, J.A., 1988. Relation between resistivity and corrosion rate  
798 of reinforcements in carbonated mortar made with several cement types. *Cem. Concr.*  
799 *Res.* 18, 687–698. [https://doi.org/10.1016/0008-8846\(88\)90091-9](https://doi.org/10.1016/0008-8846(88)90091-9)

800 Andrade, C., 2010. ELECTRICAL RESISTIVITY AS MICROSTRUCTURAL  
801 PARAMETER FOR THE MODELLING OF SERVICE LIFE OF REINFORCED  
802 CONCRETE STRUCTURES. 2nd Int. Symp. Serv. Life Des. *Infrastruct.* 10.

803 Andrade, C., Alonso, C., Sarría, J., 1998. Influencia de la humedad relativa y la temperatura  
804 en las velocidades de corrosión de estructuras de hormigón. *Mater. Constr.* 48, 5–17.  
805 <https://doi.org/10.3989/mc.1998.v48.i251.468>

806 Antoni, M., Rossen, J., Martirena, F., Scrivener, K., 2012. Cement substitution by a  
807 combination of metakaolin and limestone. *Cem. Concr. Res.* 42, 1579–1589.  
808 <https://doi.org/10.1016/j.cemconres.2012.09.006>

809 Arumugam, C., 2022. Polymer and non-polymer admixtures for concrete roofs: Thermal and  
810 mechanical properties, energy saving and carbon emission mitigation prospective. *J.*  
811 *Build. Eng.* 16.

812 ATILH, 2017. Déclaration Environnementale de Produit in French / Environmental Product  
813 Declaration - CEM I.

814 Berodier, E., Scrivener, K., 2015. Evolution of pore structure in blended systems. *Cem.*  
815 *Concr. Res.* 73, 25–35. <https://doi.org/10.1016/j.cemconres.2015.02.025>

816 Bolte, G., Zajac, M., Skocek, J., Ben Haha, M., 2019. Development of composite cements  
817 characterized by low environmental footprint. *J. Clean. Prod.* 226, 503–514.  
818 <https://doi.org/10.1016/j.jclepro.2019.04.050>

819 Bouteiller, V., Cherrier, J.-F., L’Hostis, V., Rebolledo, N., Andrade, C., Victoire, E.M., 2012.  
820 Influence of humidity and temperature on the corrosion of reinforced concrete prisms.  
821 *Eur. J. Environ. Civ. Eng.* 16, 471. <https://doi.org/10.1080/19648189.2012.668004>

822 Bucher, R., Diederich, P., Escadeillas, G., Cyr, M., 2017. Service life of metakaolin-based  
823 concrete exposed to carbonation. *Cem. Concr. Res.* 99, 18–29.  
824 <https://doi.org/10.1016/j.cemconres.2017.04.013>

825 Carcasses, M., Cussigh, F., toutlemonde, F., 2021. Definition of performance thresholds  
826 according to exposure classes in french “Définition de seuils de performance en  
827 fonction des classes d’exposition.”

828 Cardinaud, G., Rozière, E., Martinage, O., Loukili, A., Barnes-Davin, L., Paris, M., Deneele,  
829 D., 2021. Calcined clay – Limestone cements: Hydration processes with high and low-  
830 grade kaolinite clays. *Constr. Build. Mater.* 277, 122271.  
831 <https://doi.org/10.1016/j.conbuildmat.2021.122271>

832 Chen, B., Kuznik, F., Horgnies, M., Johannes, K., Morin, V., Gengembre, E., 2019.  
833 Physicochemical properties of ettringite/meta-ettringite for thermal energy storage:  
834 Review. *Sol. Energy Mater. Sol. Cells* 193, 320–334.  
835 <https://doi.org/10.1016/j.solmat.2018.12.013>

836 Chen, C., Habert, G., Bouzidi, Y., Jullien, A., Ventura, A., 2010. LCA allocation procedure  
837 used as an incitative method for waste recycling: An application to mineral additions  
838 in concrete. *Resour. Conserv. Recycl.* 54, 1231–1240.  
839 <https://doi.org/10.1016/j.resconrec.2010.04.001>

840 Chidiac, S.E., Shafikhani, M., 2020. Electrical resistivity model for quantifying concrete  
841 chloride diffusion coefficient. *Cem. Concr. Compos.* 113, 103707.  
842 <https://doi.org/10.1016/j.cemconcomp.2020.103707>

843 Chopperla, K.S.T., Ideker, J.H., 2022. Using electrical resistivity to determine the efficiency  
844 of supplementary cementitious materials to prevent alkali-silica reaction in concrete.  
845 *Cem. Concr. Compos.* 125, 104282.  
846 <https://doi.org/10.1016/j.cemconcomp.2021.104282>

847 Di Filippo, J., Karpman, J., DeShazo, J.R., 2019. The impacts of policies to reduce CO2  
848 emissions within the concrete supply chain. *Cem. Concr. Compos.* 101, 67–82.  
849 <https://doi.org/10.1016/j.cemconcomp.2018.08.003>

850 du Plooy, R., Palma Lopes, S., Villain, G., Dérobert, X., 2013. Development of a multi-ring  
851 resistivity cell and multi-electrode resistivity probe for investigation of cover concrete  
852 condition. *NDT E Int.* 54, 27–36. <https://doi.org/10.1016/j.ndteint.2012.11.007>

853 EN 197-5:2021, CEN/TC 51, Cement — Part 5: Portland-composite cement CEM II/C-M and  
854 Composite cement CEM VI, 2021.

855 Farissi, A.E., 2020. Prédiction de la durée d'utilisation des ouvrages en béton armé par une  
856 approche performantielle dans le cas de la corrosion induite par la carbonatation ou  
857 l'attaque des ions chlorure in French / Prediction of the duration of use of reinforced  
858 concrete structures by a performance approach in the case of corrosion induced by  
859 carbonation or attack of chloride ions (phdthesis). Université de La Rochelle.  
860 <https://doi.org/10/document>

861 François, R., Laurens, S., Deby, F., 2018. Steel Corrosion in Reinforced Concrete, in:  
862 Corrosion and Its Consequences for Reinforced Concrete Structures. Elsevier, pp. 1–  
863 41. <https://doi.org/10.1016/B978-1-78548-234-2.50001-9>

864 Gartner, E., 2004. Industrially interesting approaches to “low-CO2” cements. *Cem. Concr.*  
865 *Res.* 34, 1489–1498. <https://doi.org/10.1016/j.cemconres.2004.01.021>

866 Giergiczny, Z., 2019. Fly ash and slag. *Cem. Concr. Res.* 124, 105826.  
867 <https://doi.org/10.1016/j.cemconres.2019.105826>

868 Gruyaert, E., Van den Heede, P., De Belie, N., 2013. Carbonation of slag concrete: Effect of  
869 the cement replacement level and curing on the carbonation coefficient – Effect of  
870 carbonation on the pore structure. *Cem. Concr. Compos.* 35, 39–48.  
871 <https://doi.org/10.1016/j.cemconcomp.2012.08.024>

872 Hope BB, Ip AKC, 1987. Corrosion of steel in concrete made with slag cement. *ACI Mater J*  
873 525–31.

874 Hornbostel, K., Larsen, C.K., Geiker, M.R., 2013. Relationship between concrete resistivity  
875 and corrosion rate – A literature review. *Cem. Concr. Compos.* 39, 60–72.  
876 <https://doi.org/10.1016/j.cemconcomp.2013.03.019>

877 Huy Vu, Q., Pham, G., Chonier, A., Brouard, E., Rathnarajan, S., Pillai, R., Gettu, R.,  
878 Santhanam, M., Aguayo, F., Folliard, K.J., Thomas, M.D., Moffat, T., Shi, C., Sarnot,  
879 A., 2019. Impact of different climates on the resistance of concrete to natural  
880 carbonation. *Constr. Build. Mater.* 216, 450–467.  
881 <https://doi.org/10.1016/j.conbuildmat.2019.04.263>

882 IPCC, 2022. Climate Change 2022: Mitigation of Climate Change. Contribution to the IPCC  
883 Sixth Assessment Report.

884 Jäggi, S., Böhni, H., Elsener, B., 2007. Macrocell corrosion of steel in concrete – experiments  
885 and numerical modelling, in: *Corrosion of Reinforcement in Concrete*. Elsevier, pp.  
886 75–88. <https://doi.org/10.1533/9781845692285.75>

887 Kangni-Foli, E., Poyet, S., Le Bescop, P., Charpentier, T., Bernachy-Barbé, F., Dauzères, A.,  
888 L'Hôpital, E., d'Espinose de Lacaillerie, J.-B., 2021. Carbonation of model cement  
889 pastes: The mineralogical origin of microstructural changes and shrinkage. *Cem.*  
890 *Concr. Res.* 144, 106446. <https://doi.org/10.1016/j.cemconres.2021.106446>

891 Kocaba, V., 2009. Development and evaluation of methods to follow microstructural  
892 development of cementitious systems including slags - PhD Thesis. Ecole  
893 Polytechnique Fédérale de Lausanne (EPFL).

894 Lothenbach, B., 2010. Thermodynamic equilibrium calculations in cementitious systems.  
895 *Mater. Struct.* 43, 1413–1433. <https://doi.org/10.1617/s11527-010-9592-x>

896 Lübeck, A., Gastaldini, A.L.G., Barin, D.S., Siqueira, H.C., 2012. Compressive strength and  
897 electrical properties of concrete with white Portland cement and blast-furnace slag.  
898 *Cem. Concr. Compos.* 34, 392–399.  
899 <https://doi.org/10.1016/j.cemconcomp.2011.11.017>

900 Markeset, G., Myrdal, R., 2008. Modeling of reinforcement corrosion in concrete - State of  
901 art (No. 7).

902 Matschei, T., Lothenbach, B., Glasser, F.P., 2007. The role of calcium carbonate in cement  
903 hydration. *Cem. Concr. Res.* 37, 551–558.  
904 <https://doi.org/10.1016/j.cemconres.2006.10.013>

905 Medeiros-Junior, R.A., Lima, M.G., 2016. Electrical resistivity of unsaturated concrete using  
906 different types of cement. *Constr. Build. Mater.* 107, 11–16.  
907 <https://doi.org/10.1016/j.conbuildmat.2015.12.168>

908 Medjigbodo, G., Rozière, E., Charrier, K., Izoret, L., Loukili, A., 2018. Hydration, shrinkage,  
909 and durability of ternary binders containing Portland cement, limestone filler and  
910 metakaolin. *Constr. Build. Mater.* 183, 114–126.  
911 <https://doi.org/10.1016/j.conbuildmat.2018.06.138>

912 Mehdipour, S., Nikbin, Iman.M., Dezhampannah, S., Mohebbi, R., Moghadam, H., Charkhtab,  
913 S., Moradi, A., 2020. Mechanical properties, durability and environmental evaluation  
914 of rubberized concrete incorporating steel fiber and metakaolin at elevated  
915 temperatures. *J. Clean. Prod.* 254, 120126.  
916 <https://doi.org/10.1016/j.jclepro.2020.120126>

917 Miller, S.A., 2018. Supplementary cementitious materials to mitigate greenhouse gas  
918 emissions from concrete: can there be too much of a good thing? *J. Clean. Prod.* 178,  
919 587–598. <https://doi.org/10.1016/j.jclepro.2018.01.008>

920 Ministry for the ecological and solidary transition, 2020. National low carbon strategy-The  
921 ecological and inclusive transition towards carbon neutrality 176.

922 Morandeu, A., Thiéry, M., Dangla, P., 2014. Investigation of the carbonation mechanism of  
923 CH and C-S-H in terms of kinetics, microstructure changes and moisture properties.  
924 *Cem. Concr. Res.* 56, 153–170. <https://doi.org/10.1016/j.cemconres.2013.11.015>

925 Mounanga, P., Khokhar, M.I.A., El Hachem, R., Loukili, A., 2011. Improvement of the early-  
926 age reactivity of fly ash and blast furnace slag cementitious systems using limestone  
927 filler. *Mater. Struct.* 44, 437–453. <https://doi.org/10.1617/s11527-010-9637-1>

928 Nishikawa, T., Suzuki, K., Ito, S., Sato, K., Takebe, T., 1992. Decomposition of synthesized  
929 ettringite by carbonation. *Cem. Concr. Res.* 22, 6–14. [https://doi.org/10.1016/0008-8846\(92\)90130-N](https://doi.org/10.1016/0008-8846(92)90130-N)

930

931 Otieno, M., Beushausen, H., Alexander, M., 2014. Effect of chemical composition of slag on  
932 chloride penetration resistance of concrete. *Cem. Concr. Compos.* 46, 56–64.  
933 <https://doi.org/10.1016/j.cemconcomp.2013.11.003>

934 Palm, S., Proske, T., Rezvani, M., Hainer, S., Müller, C., Graubner, C.-A., 2016. Cements  
935 with a high limestone content – Mechanical properties, durability and ecological  
936 characteristics of the concrete. *Constr. Build. Mater.* 119, 308–318.  
937 <https://doi.org/10.1016/j.conbuildmat.2016.05.009>

938 Papadakis, V., Vayenas, C., Fardis, M., 1991. Physical and Chemical Characteristics  
939 Affecting the Durability of Concrete. *ACI Mater. J.* 88, 186–196.

940 Papadakis, V.G., Vayenas, C.G., Fardis, M.N., 1991. Fundamental Modeling and  
941 Experimental Investigation of Concrete Carbonation. *Mater. J.* 88, 363–373.  
942 <https://doi.org/10.14359/1863>

943 Poyet, S., 2013. Determination of the intrinsic permeability to water of cementitious  
944 materials: Influence of the water retention curve. *Cem. Concr. Compos.* 35, 127–135.  
945 <https://doi.org/10.1016/j.cemconcomp.2012.08.023>

- 946 Proske, T., Rezvani, M., Palm, S., Müller, C., Graubner, C.-A., 2018. Concretes made of  
 947 efficient multi-composite cements with slag and limestone. *Cem. Concr. Compos.* 89,  
 948 107–119. <https://doi.org/10.1016/j.cemconcomp.2018.02.012>
- 949 R.F.M. Bakker, 1993. Model to calculate the rate of carbonation resistance of concrete under  
 950 different climatic conditions,. Rapp CEMIJ Bv Lab Imuiden Holl.
- 951 Roy, D.M., Idorn, G.M., 1982. Hydration, Structure, and Properties of Blast Furnace Slag  
 952 Cements, Mortars, and Concrete. *ACI J. Proc.* 79. <https://doi.org/10.14359/10919>
- 953 Rozière, E., Loukili, A., Cussigh, F., 2009. A performance based approach for durability of  
 954 concrete exposed to carbonation. *Constr. Build. Mater.* 23, 190–199.  
 955 <https://doi.org/10.1016/j.conbuildmat.2008.01.006>
- 956 Scrivener, K.L., John, V.M., Gartner, E.M., 2018. Eco-efficient cements: Potential  
 957 economically viable solutions for a low-CO2 cement-based materials industry. *Cem.*  
 958 *Concr. Res.* 114, 2–26. <https://doi.org/10.1016/j.cemconres.2018.03.015>
- 959 Shah, V., Scrivener, K., Bhattacharjee, B., Bishnoi, S., 2018. Changes in microstructure  
 960 characteristics of cement paste on carbonation. *Cem. Concr. Res.* 109, 184–197.  
 961 <https://doi.org/10.1016/j.cemconres.2018.04.016>
- 962 Shi, Z., Lothenbach, B., Geiker, M.R., Kaufmann, J., Leemann, A., Ferreira, S., Skibsted, J.,  
 963 2016. Experimental studies and thermodynamic modeling of the carbonation of  
 964 Portland cement, metakaolin and limestone mortars. *Cem. Concr. Res.* 88, 60–72.  
 965 <https://doi.org/10.1016/j.cemconres.2016.06.006>
- 966 Stefanoni, M., Angst, U.M., Elsener, B., 2018. Electrochemistry and capillary condensation  
 967 theory reveal the mechanism of corrosion in dense porous media. *Sci. Rep.* 8, 7407.  
 968 <https://doi.org/10.1038/s41598-018-25794-x>
- 969 Thiery, M., Cremona, C., Baroghel-Bouny, V., 2012. Application of the reliability theory to  
 970 the assessment of carbonation-induced corrosion risk of rebars. *Eur. J. Environ. Civ.*  
 971 *Eng.* 16, 273–287. <https://doi.org/10.1080/19648189.2012.667987>
- 972 Torres-Acosta, A.A., Sagues, A.A., 2004. Concrete Cracking by Localized Steel Corrosion--  
 973 Geometric Effects. *Mater. J.* 101, 501–507. <https://doi.org/10.14359/13489>
- 974 Turcry, P., J. Mai-Nhu, E. Rozière, B. Thauvin, F. Cussigh, 2019. French project “PerfDub”  
 975 on performance-based approach: from Round-Robin tests to new test procedures for  
 976 durability indicators and accelerated carbonation. *Proc. Fib Symp. Concr. – Innov.*  
 977 *Mater. Des. Struct.* 505–512.
- 978 Tuutti, K., 1982. Corrosion of steel in concrete. *Swed. Cem. Concr. Res. Inst. Stockh.*
- 979 van Noort, R., Hunger, M., Spiesz, P., 2016. Long-term chloride migration coefficient in slag  
 980 cement-based concrete and resistivity as an alternative test method. *Constr. Build.*  
 981 *Mater.* 115, 746–759. <https://doi.org/10.1016/j.conbuildmat.2016.04.054>
- 982 Vollpracht, A., Lothenbach, B., Snellings, R., Haufe, J., 2016. The pore solution of blended  
 983 cements: a review. *Mater. Struct.* 49, 3341–3367. <https://doi.org/10.1617/s11527-015-0724-1>
- 984
- 985 Wang, X.-Y., Lee, H.-S., 2019. Effect of global warming on the proportional design of low  
 986 CO2 slag-blended concrete. *Constr. Build. Mater.* 225, 1140–1151.  
 987 <https://doi.org/10.1016/j.conbuildmat.2019.07.134>
- 988 Wierig HJ, 1984. Longtime studies on the carbonation of concrete under normal outdoor  
 989 exposure. In: *Proceedings of the RILEM seminar on the durability of concrete*  
 990 *structures under normal outdoor exposure* 239–49.
- 991 Yang, K.-H., Jung, Y.-B., Cho, M.-S., Tae, S.-H., 2017. Effect of Supplementary  
 992 Cementitious Materials on Reduction of CO2 Emissions From Concrete, in:  
 993 *Handbook of Low Carbon Concrete.* Elsevier, pp. 89–110.  
 994 <https://doi.org/10.1016/B978-0-12-804524-4.00005-1>
- 995