

Houses divided

The stratigraphy of Khafajeh's
ED III residential neighbourhoods
around the Oval Temple

Amaury Havé, PhD candidate

@amaury_h@freeradical.zone
have.amaury@gmail.com



VEPMO
Du Village à l'État
au Proche et Moyen-Orient



Introduction



ED stemmed dishes, subtype A

18 stemmed-dishes subtypes

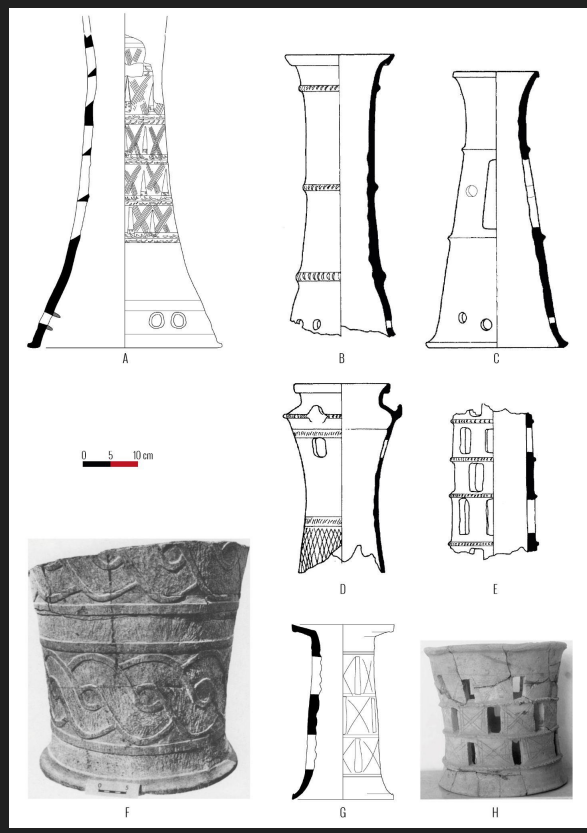
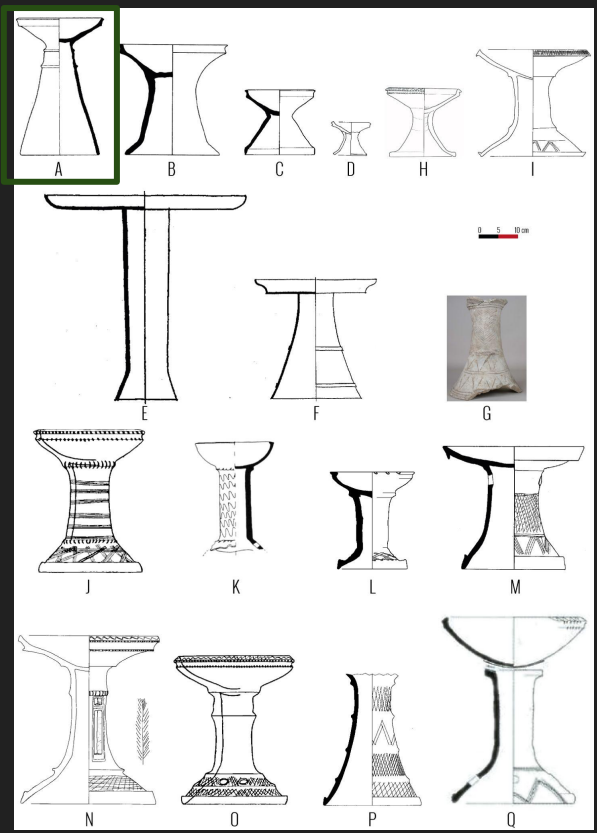

ED stemmed dishes, subtype A

Subtype A: elongated shape, various decoration

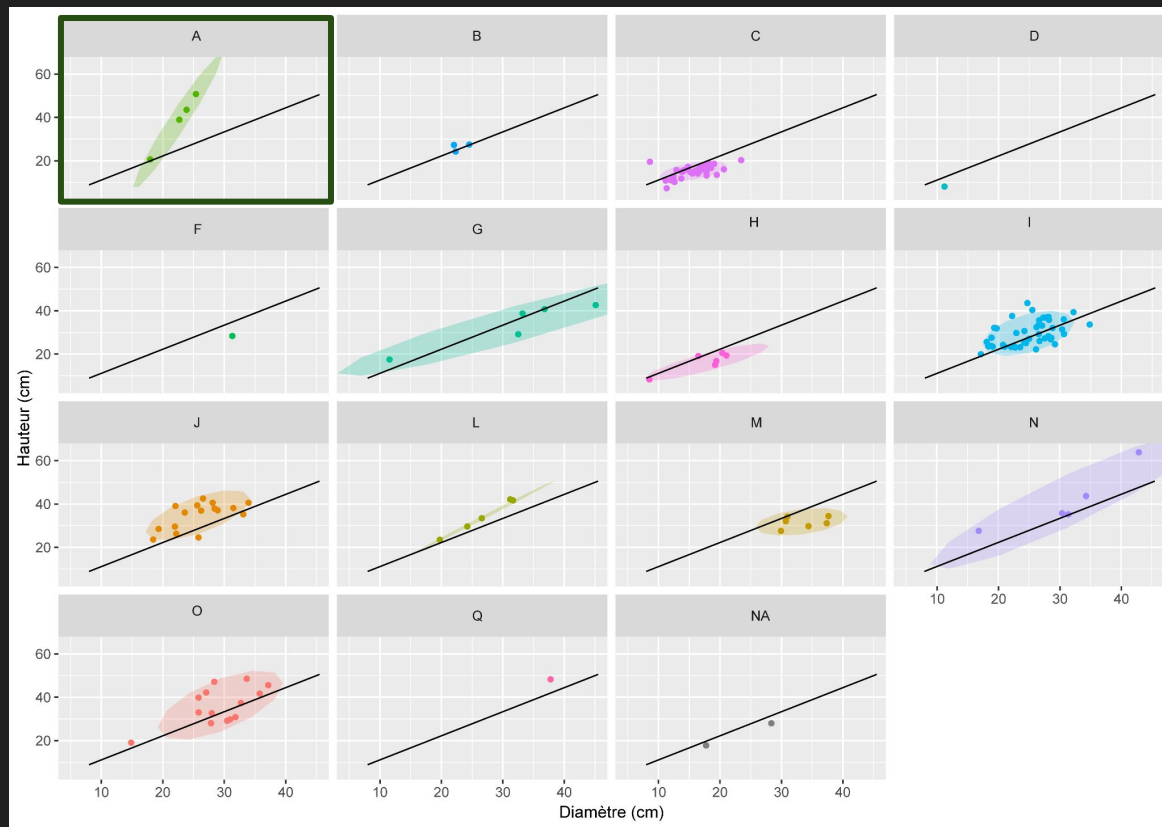
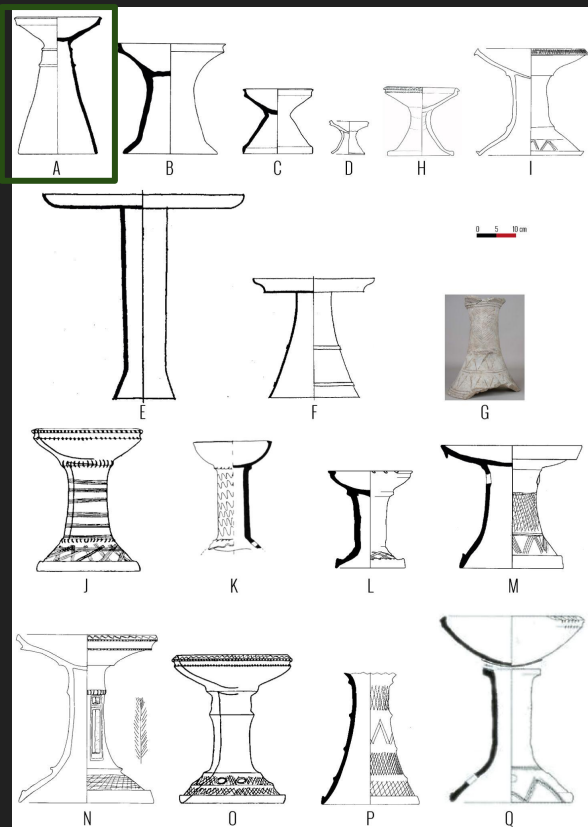

ED stemmed dishes, subtype A

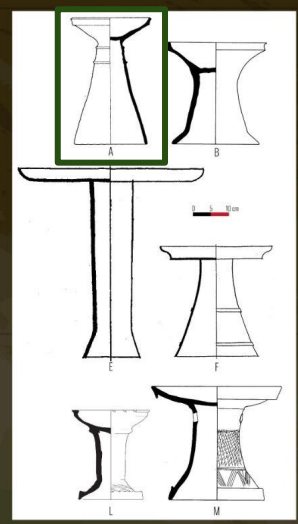
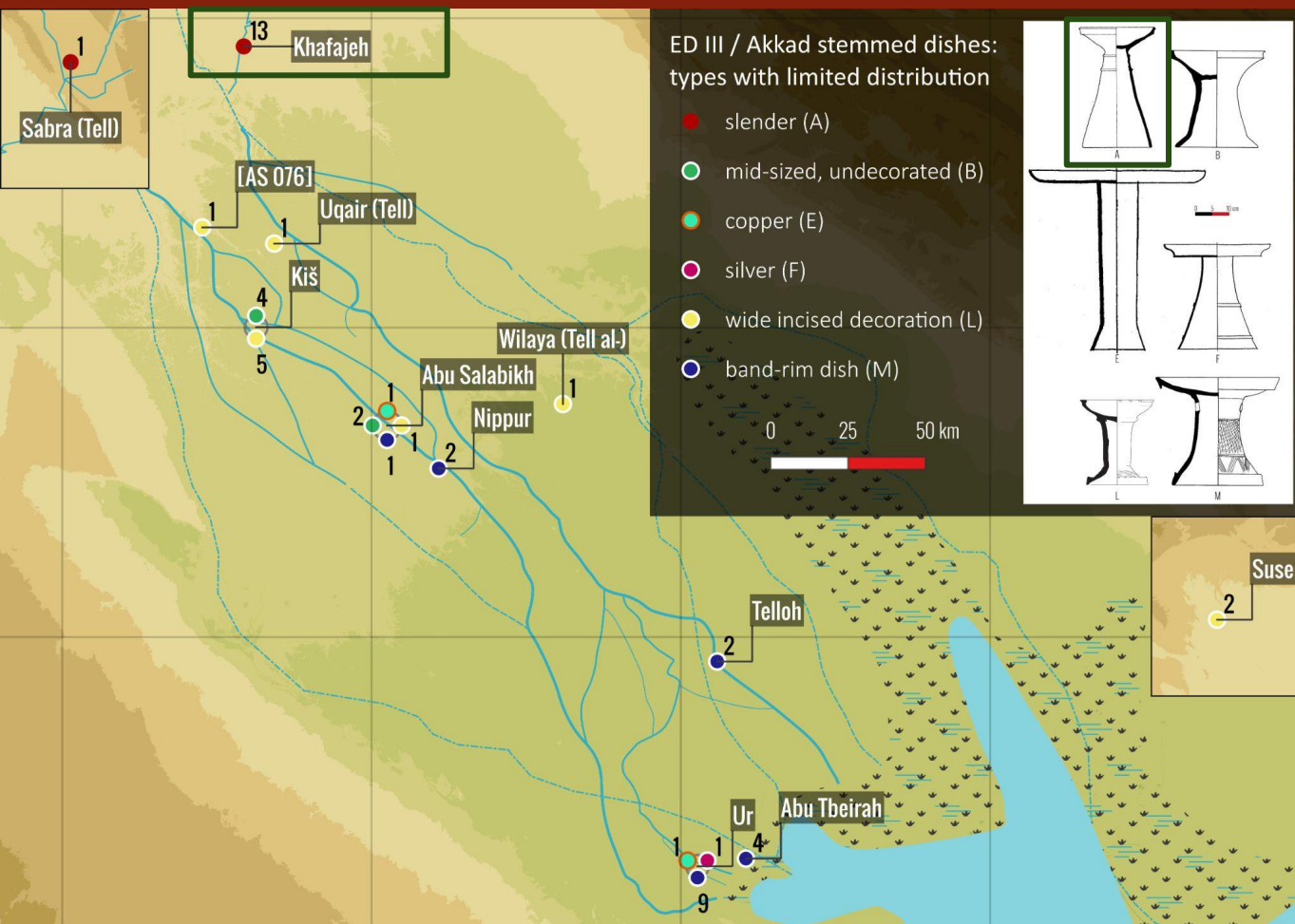

Once upon a time in the Diyala region

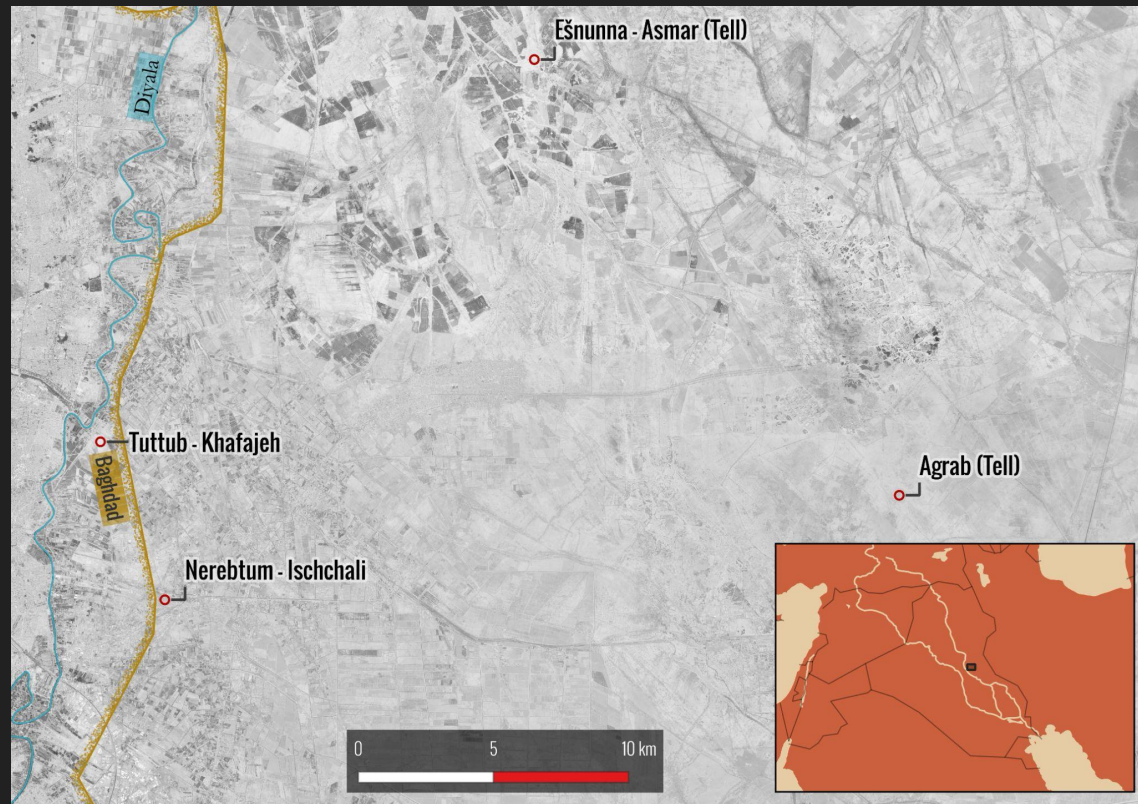

Excavation at Khafajeh in 1930-1938, focus around the Oval Temple

Once upon a time in the Diyala region

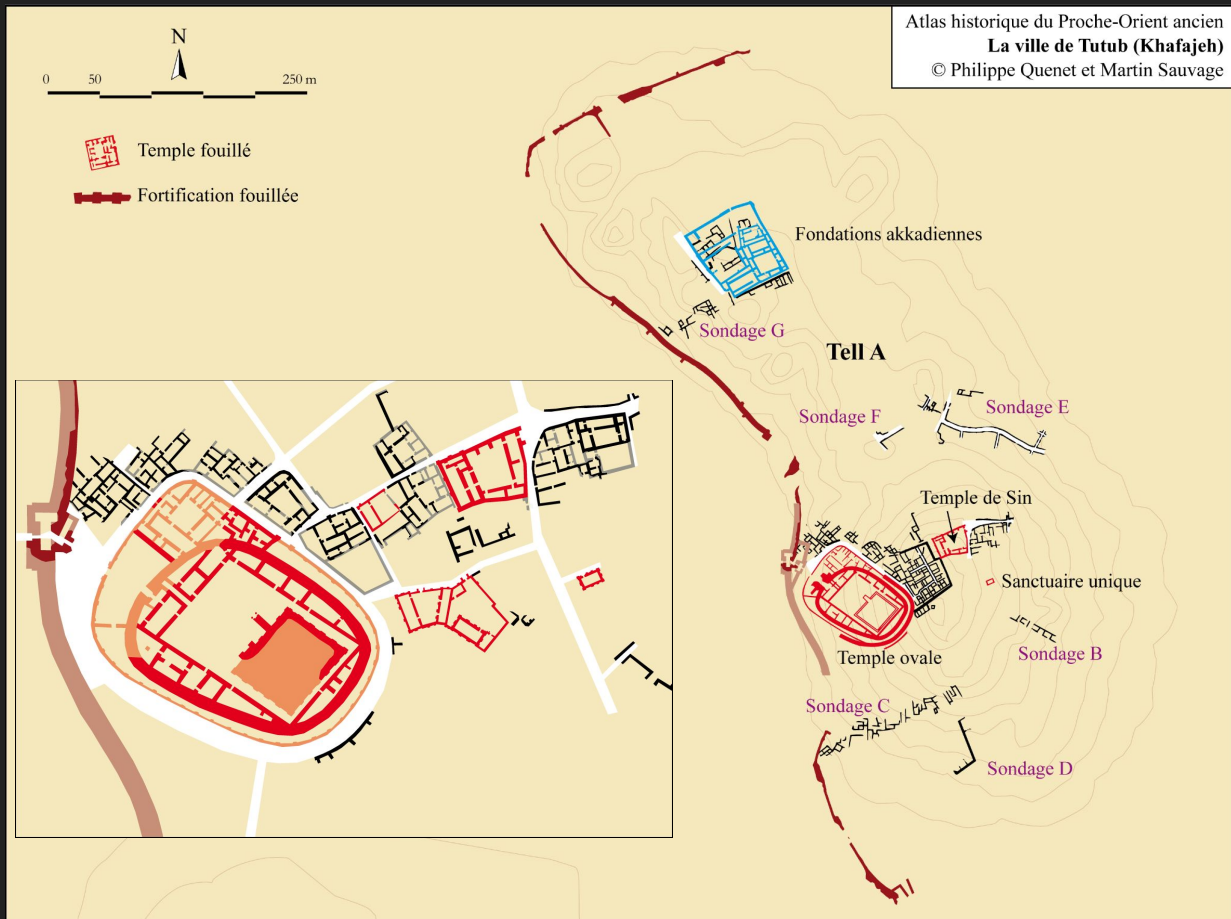

12 successive residential areas between the Oval Temple and the Sin Temple

Once upon a time in the Diyala region

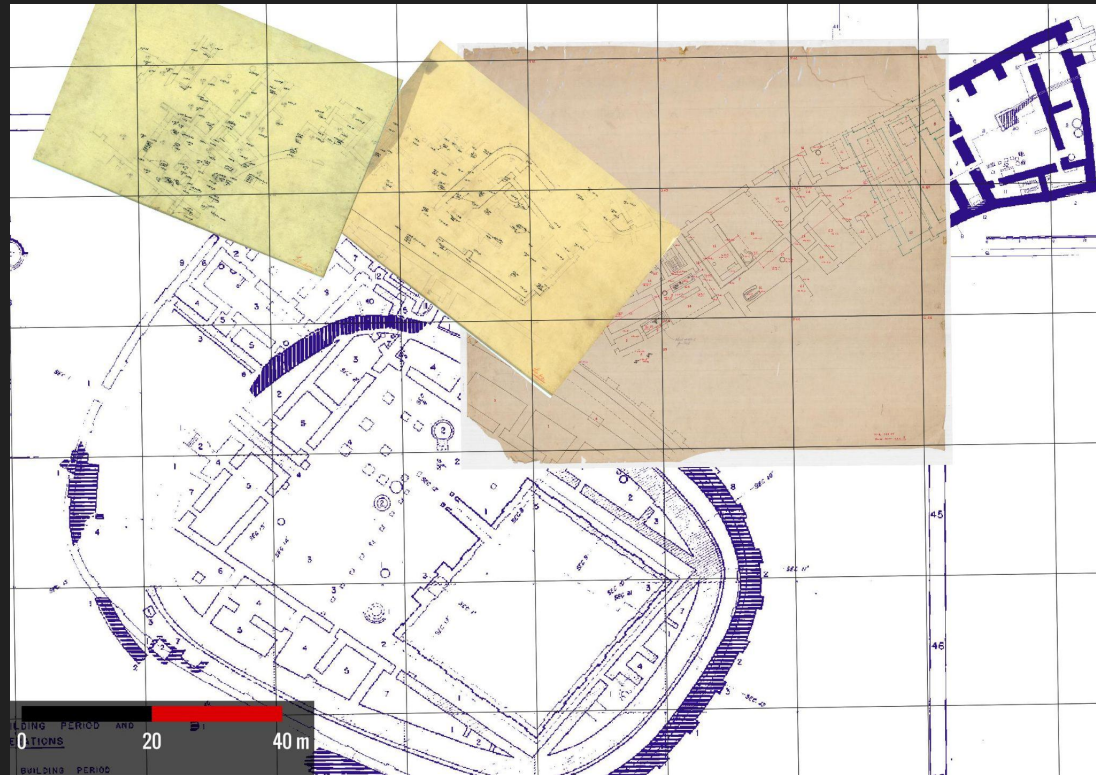

Sunday, February 26th., 1933.

Work continued at the same points. Besides we started on following all drains coming out of the oval and House D, in order to establish time connection between different levels inside and outside the Oval.

All the drains, as well as the stairs and the gate, seem to indicate that a higher level inside the oval is contemporary with a lower level outside it, so that the ruins and graves at the K-42, J-42 area seem to be of a later building period than House D, and the part of the Oval connected with it.

DiyArDa : <https://dialadb01.uchicago.edu/>



Creating a post-excavation GIS from the DiyArDa plans

Houses 3, a composite level

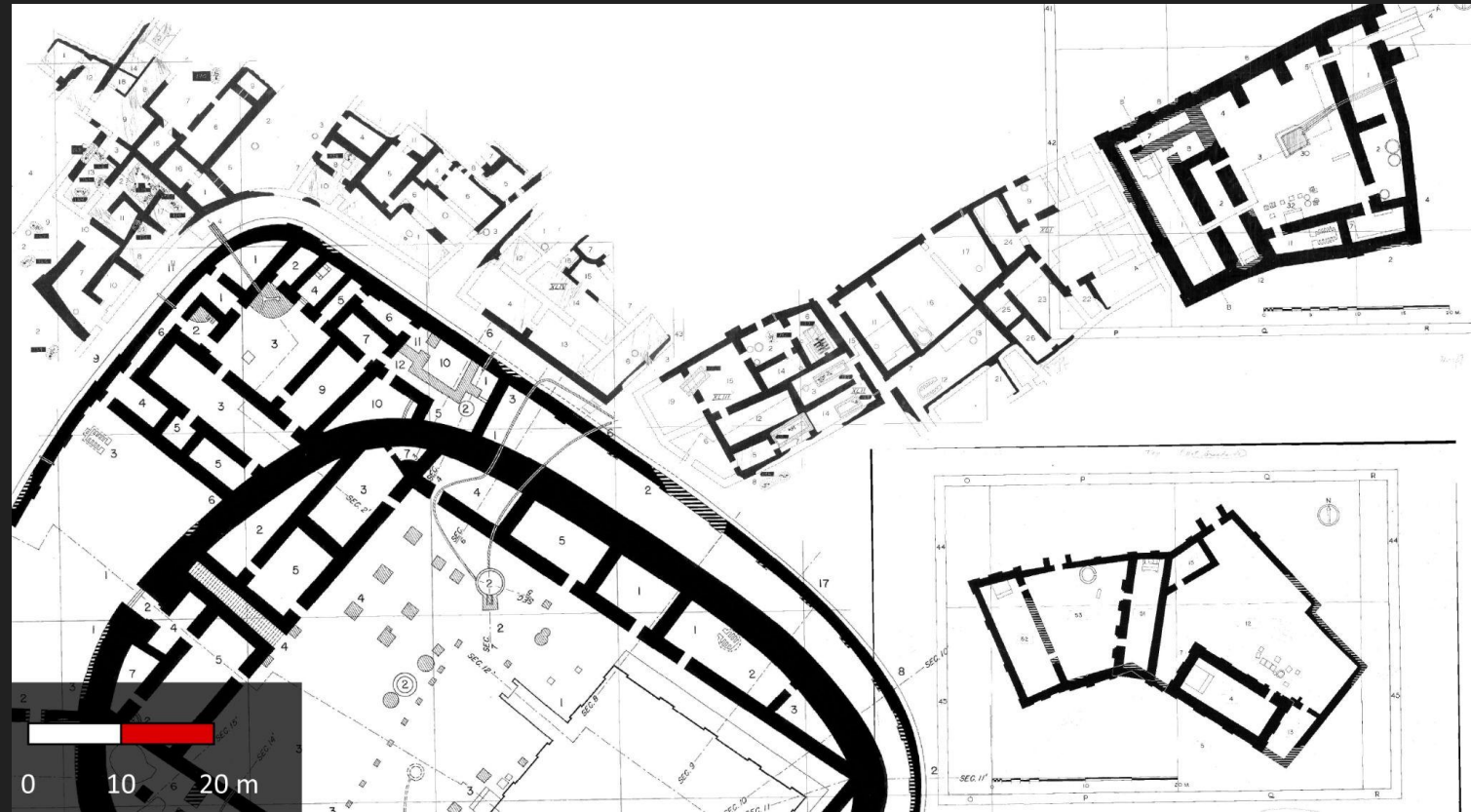

Houses 3, a composite level



Stemmed dishes from Houses 4-3, Oval I and Sin IX

Houses 3, a composite level



Stemmed dishes from Houses 4-3, Oval I and Sin IX

Houses 3, a composite level



No transversal section through the Houses area(s)

Houses 3, a composite level

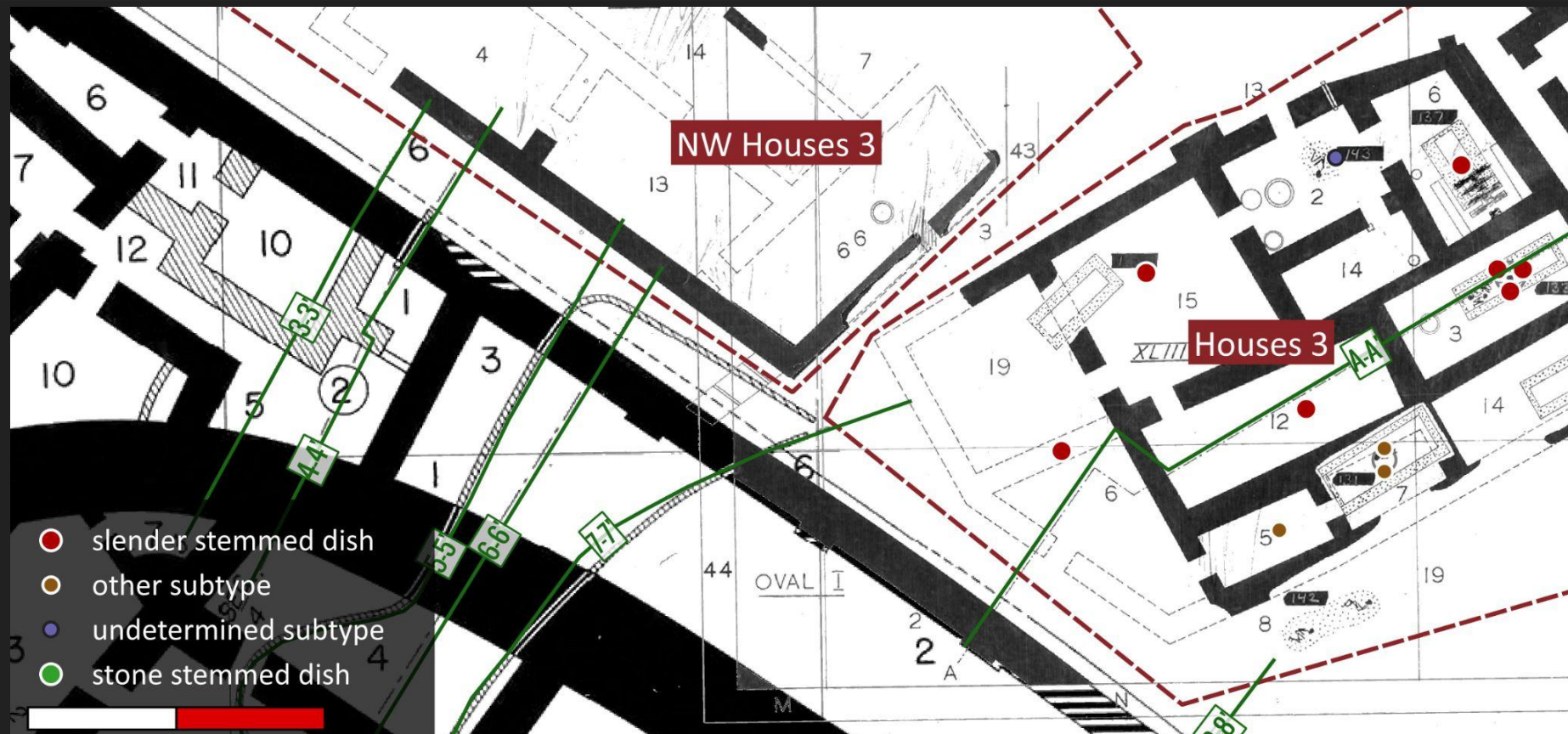

No transversal section through the Houses area(s)

Divergent chronological attributions

Houses	Delougaz et al. 1967	ARCANE (2009)	Gibson 2011	Marchesi & Marchetti 2011	Dittmann 2015	Stefanski 2018
1	ED IIIB	Early Akkad	ED IIIB / Early Akkad		F	Early-Late Akkad
2	ED III A / ED IIIB	ED IIIB	ED IIIA	ED IIIB		Early Akkad
Ash						
3	ED IIIA	ED IIIA	ED IIIA	ED IIIA	E	Transitional
4	ED II					ED III
5					D ?	Late ED I (=ED II)

In the burnt building we found in the central room J-4^B/5, a fragment of Akkadian tablet.

Delougaz excavation journal, 1933, p. 132

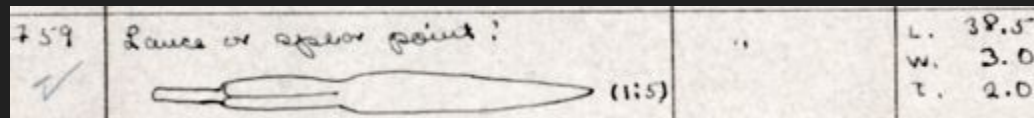

Spearhead Kh. III 759: close parallel at Ur (Stefanski 2018)

Divergent chronological attributions

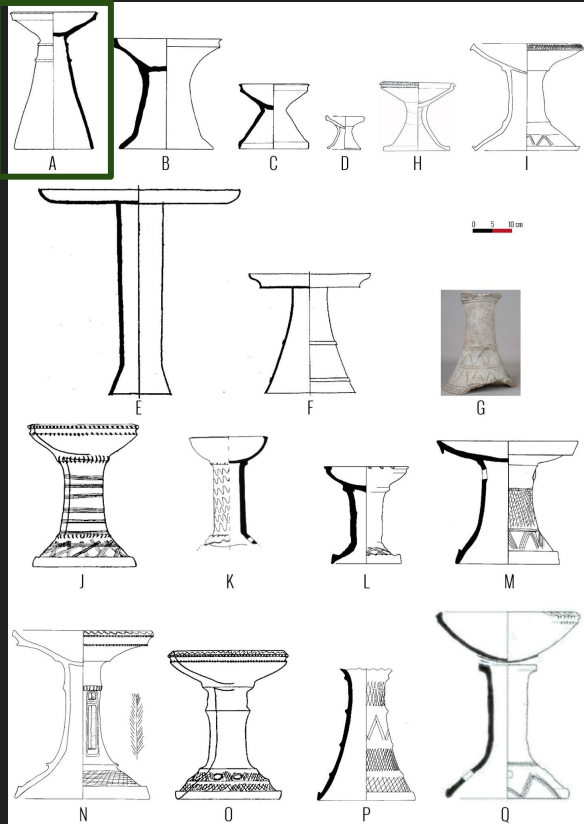

Propozed periods	Houses Level	Subtype A	Other subtypes
ED IIIB to Late Akkad	H1		
ED IIIA to Early Akkad	H2		
ED IIIA to transitional	H3		
ED II to ED III	H4		
ED II to ED IIIA	H5		
	H6		

Oval Temple II: two main subphasing possibilities



3 main architectural parts probably belonging to the same building (Oval II), but with several combination possibilities

Oval Temple II: two main subphasing possibilities

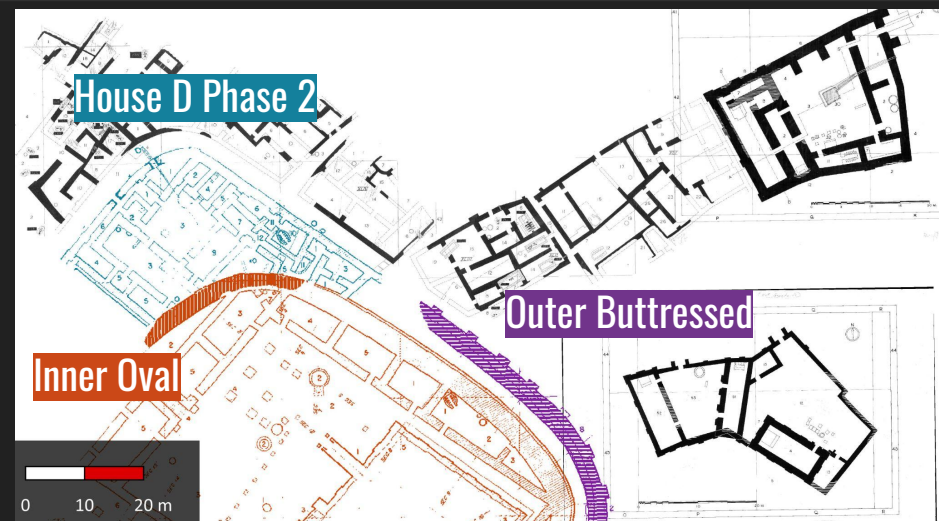

Delougaz 1940:

Two subphases (Oval IIA/ Oval IIB) with complete buttressed wall (covering House D), or one phase (Oval II) with partial buttressed wall (not covering House D).

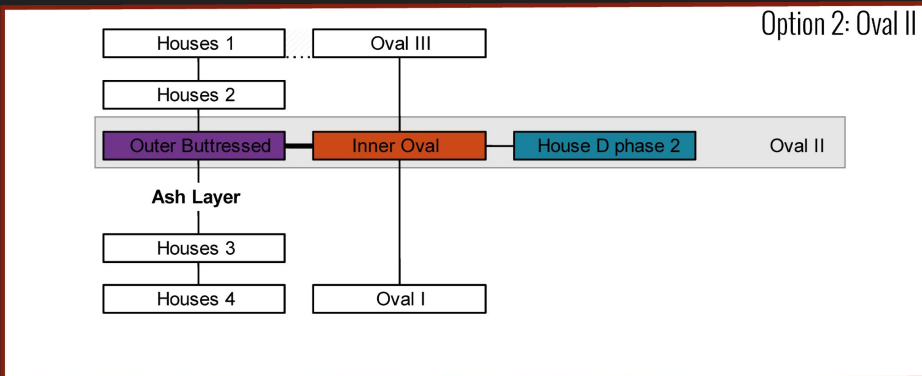
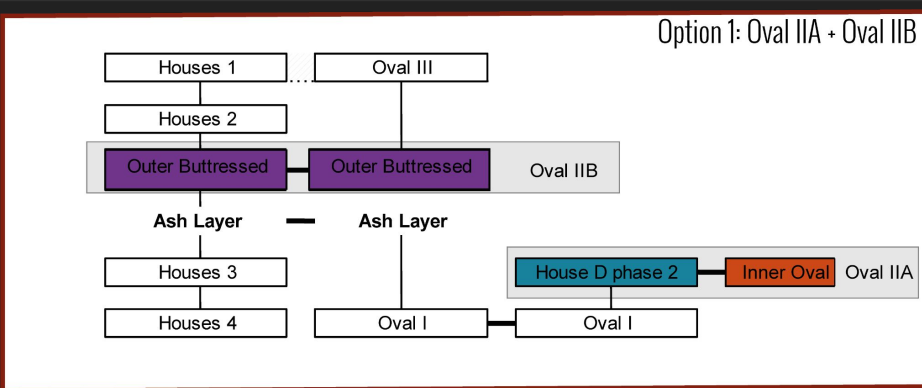

Other options dismissed already by Delougaz.

Oval Temple II: two main subphasing possibilities

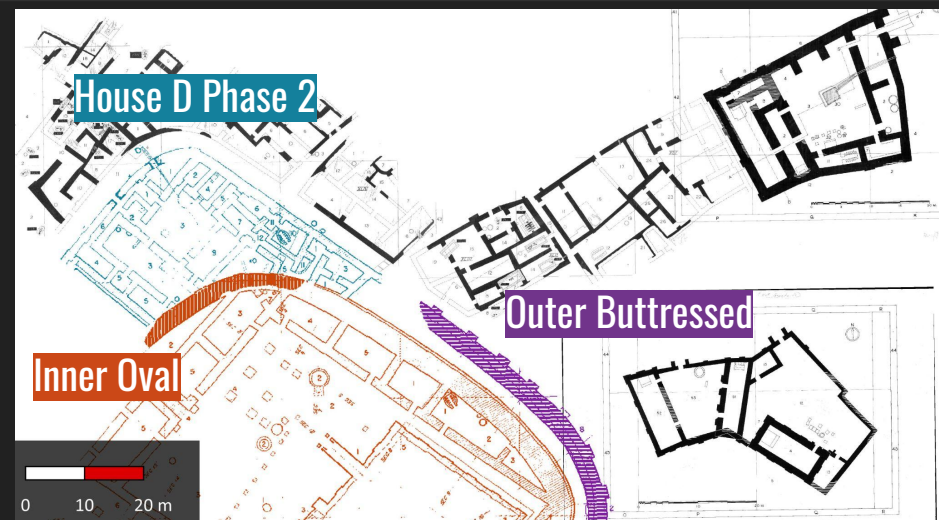

Other interpretations: Tunca 1984 (Outer Buttressed = «Oval IV»), Palmero Fernández 2019 (strong continuity between Oval I and II)

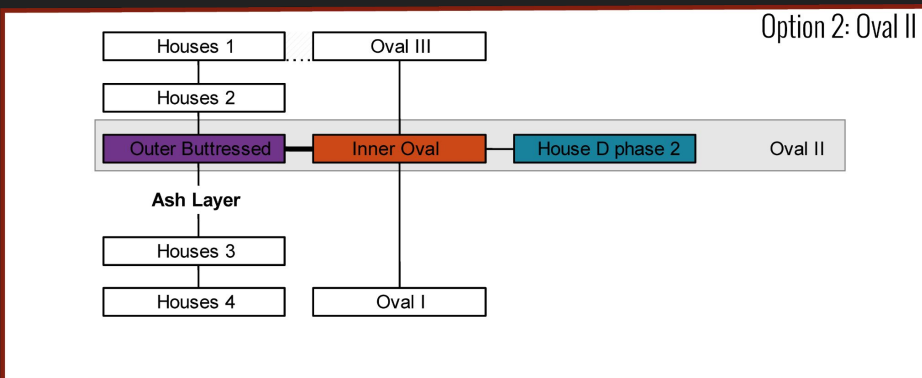
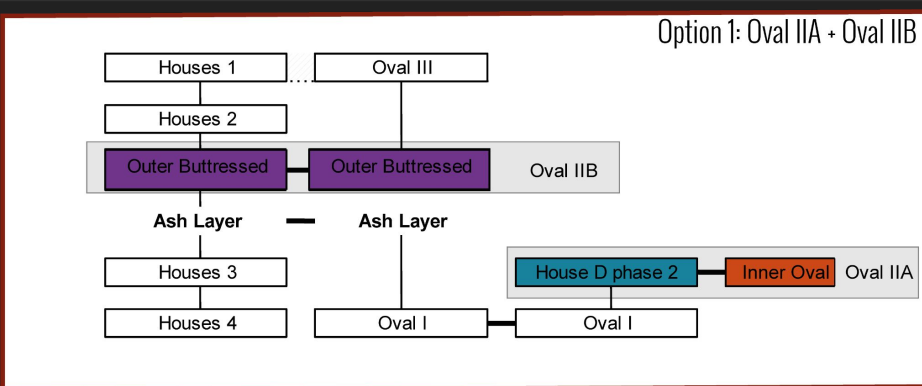

Option 1: adopted & expanded by Vallet (2001, 2019, 2020), Stefanski (2018)
Option 2: preferred by Delougaz (1940, p. 107), followed by Margueron (2007)

Oval Temple II: two main subphasing possibilities

A misleading hatch pattern on sections 11-11' and 8-8'

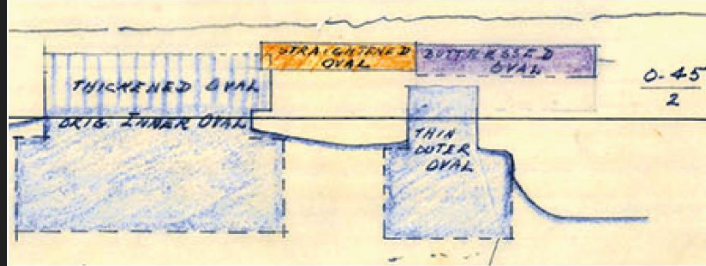
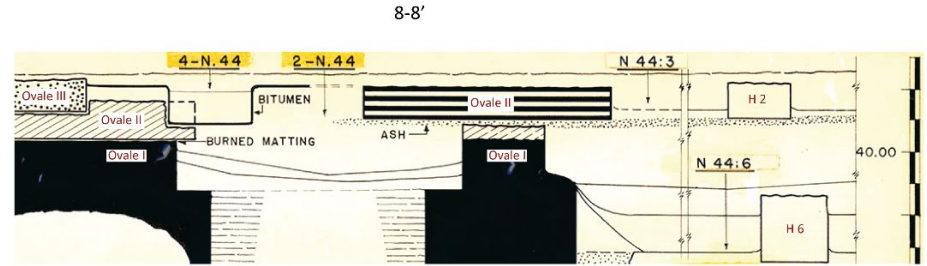
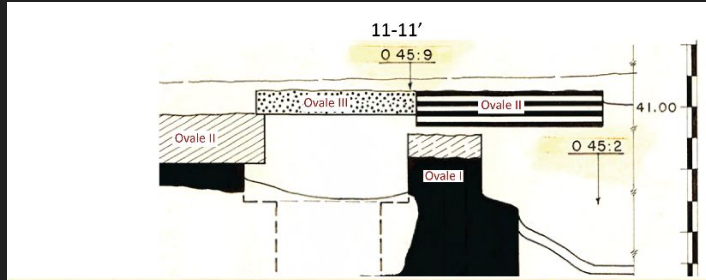

G

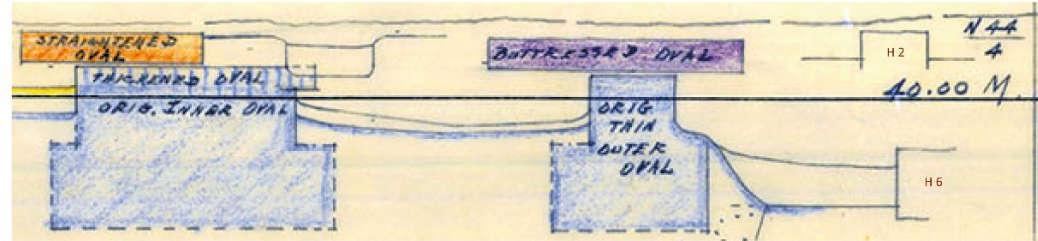

D

Vallet 2019 p. 243: [about section 8-8'] : « La coupe montre qu'à cet endroit, l'enceinte à pilastres repose sur la couche de cendres, et que cette dernière recouvre non pas l'enceinte du niveau I, mais une reconstruction à l'identique de celle-ci. »

Delougaz 1940 p. 107: « the [Oval I] outer wall [...] presumably remained undamaged » // « we are led to assume that the building of the buttressed outer wall was carried out simultaneously with, or not much later than, the rebuilding of the oval inner wall and the platform »

Oval Temple II: two main subphasing possibilities

A misleading hatch pattern on sections 11-11' and 8-8

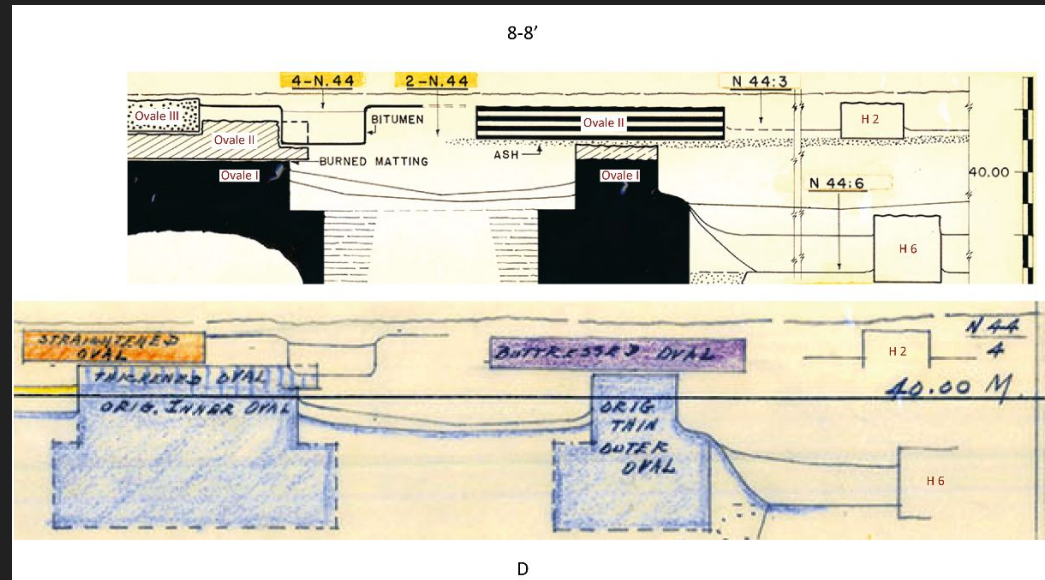
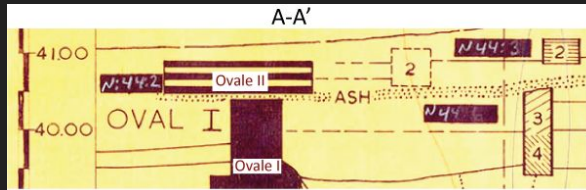

Vallet 2019 p. 243: [about section 8-8'] : « La coupe montre qu'à cet endroit, l'enceinte à pilastres repose sur la couche de cendres, et que cette dernière recouvre non pas l'enceinte du niveau I, mais une reconstruction à l'identique de celle-ci. »

Delougaz 1940 p. 107: « the [Oval I] outer wall [...] presumably remained undamaged » // « we are led to assume that the building of the buttressed outer wall was carried out simultaneously with, or not much later than, the rebuilding of the oval inner wall and the platform »

Linking Houses 3 and an "option 2" Oval II

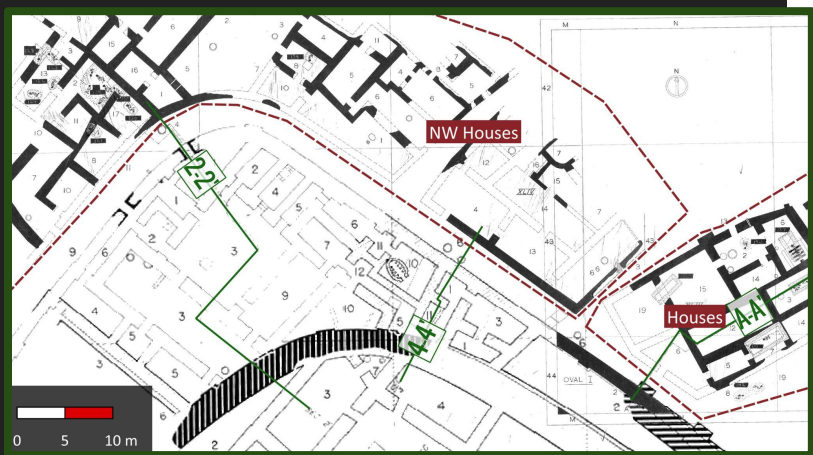
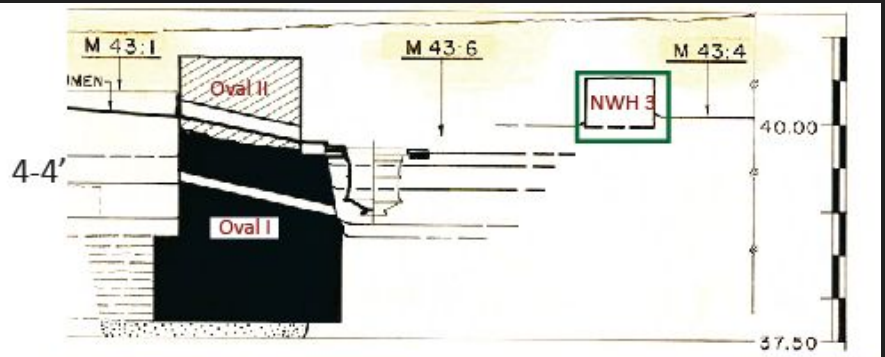
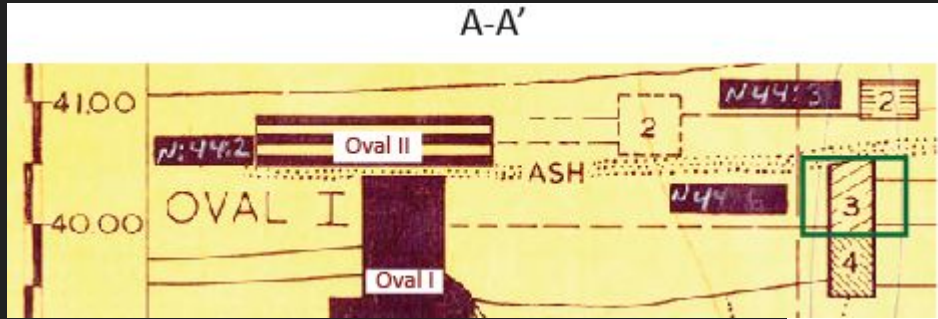

2-2' (=C-C')

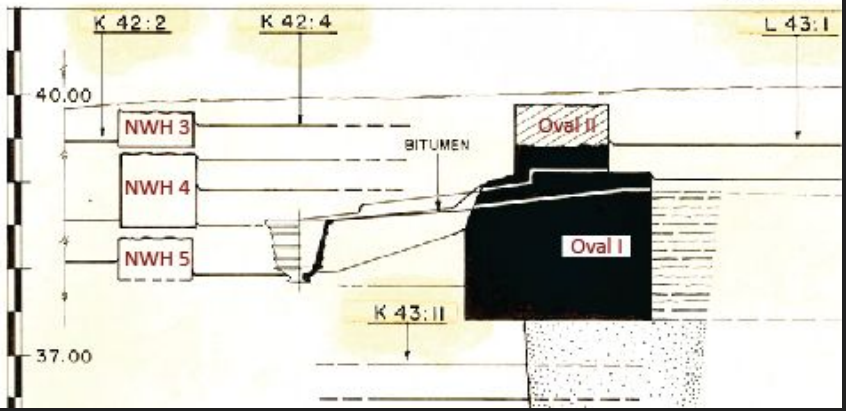

Opposite relationship on each side of the Houses area

Linking Houses 3 and an "option 2" Oval II

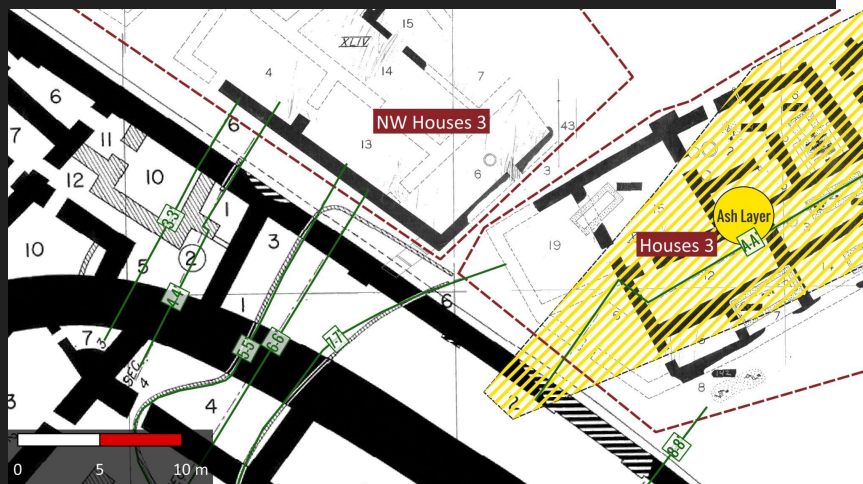
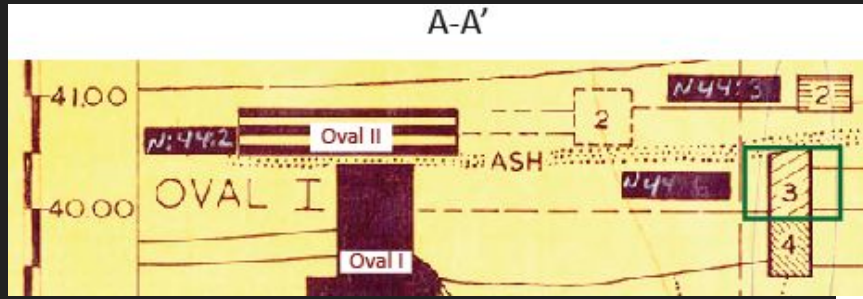

Heights for Houses levels and Oval II features

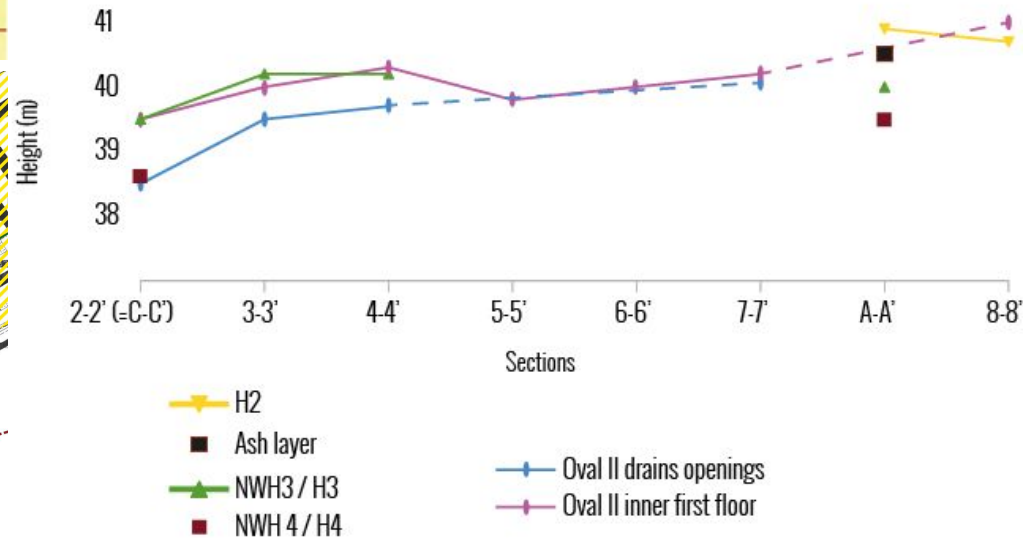

Ashes over easter Houses, not appearing on the western part

Linking Houses 3 and an "option 2" Oval II

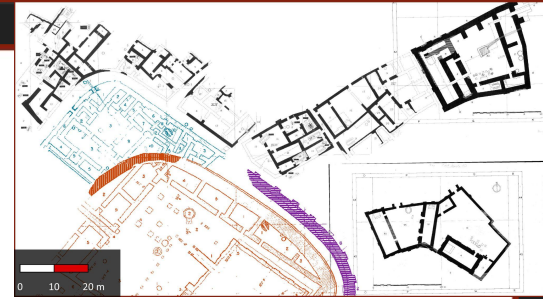
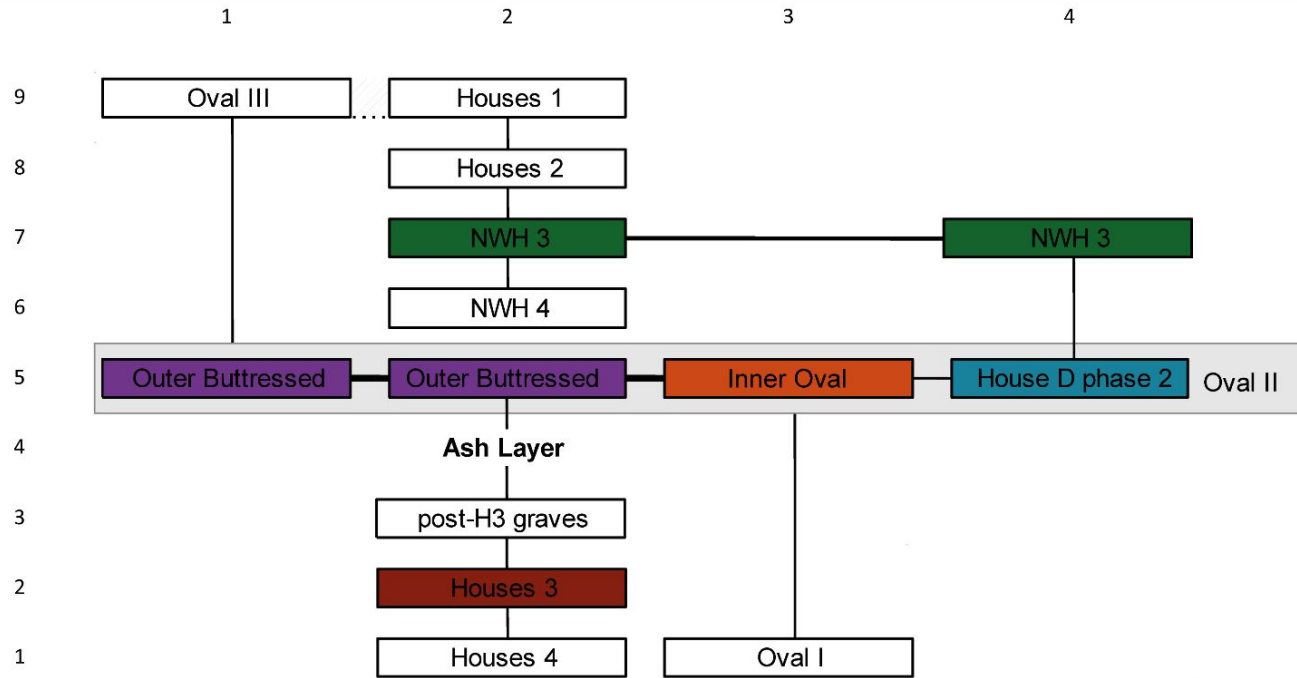

Linking Houses 3 and an "option 2" Oval II

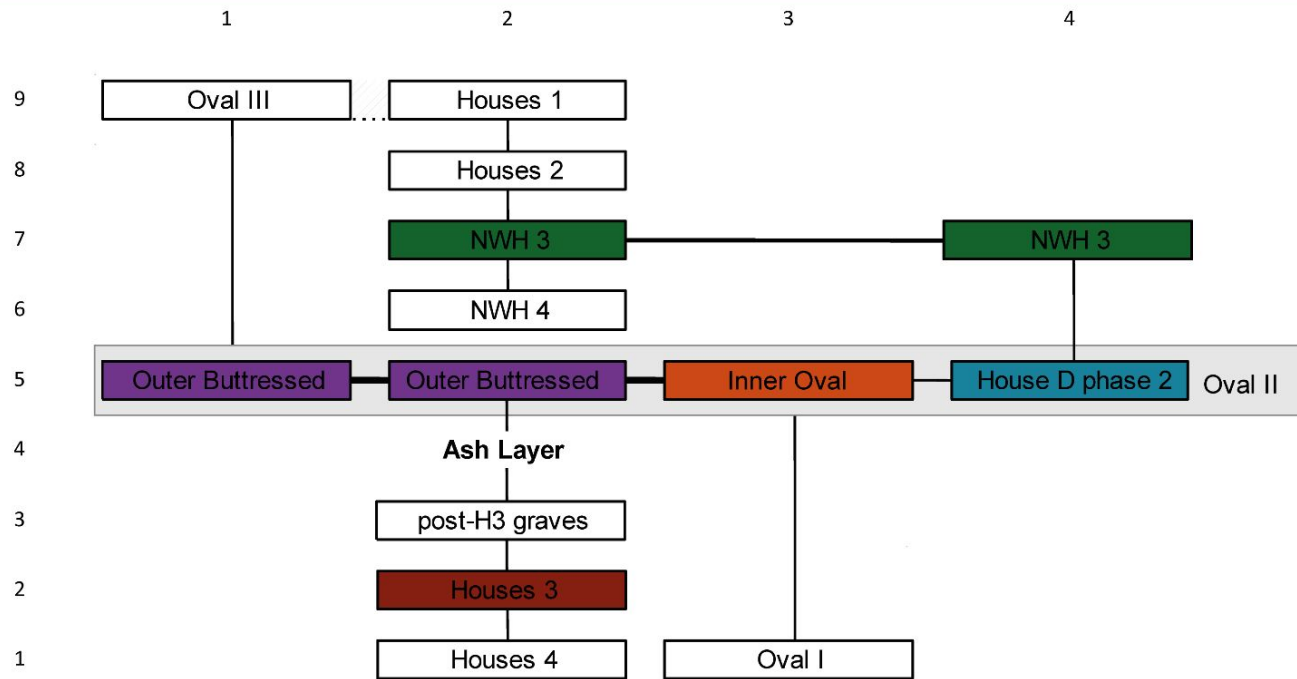

Linking Houses 3 and an "option 2" Oval II

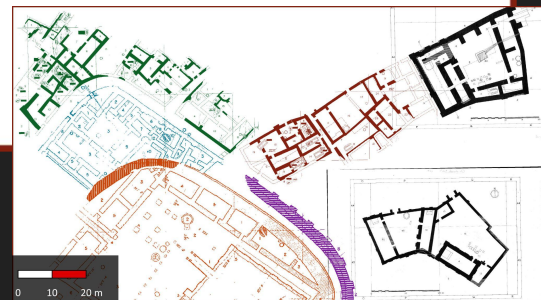
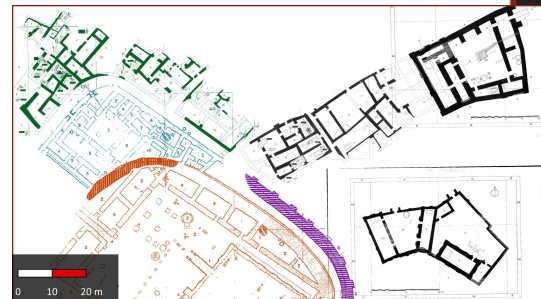
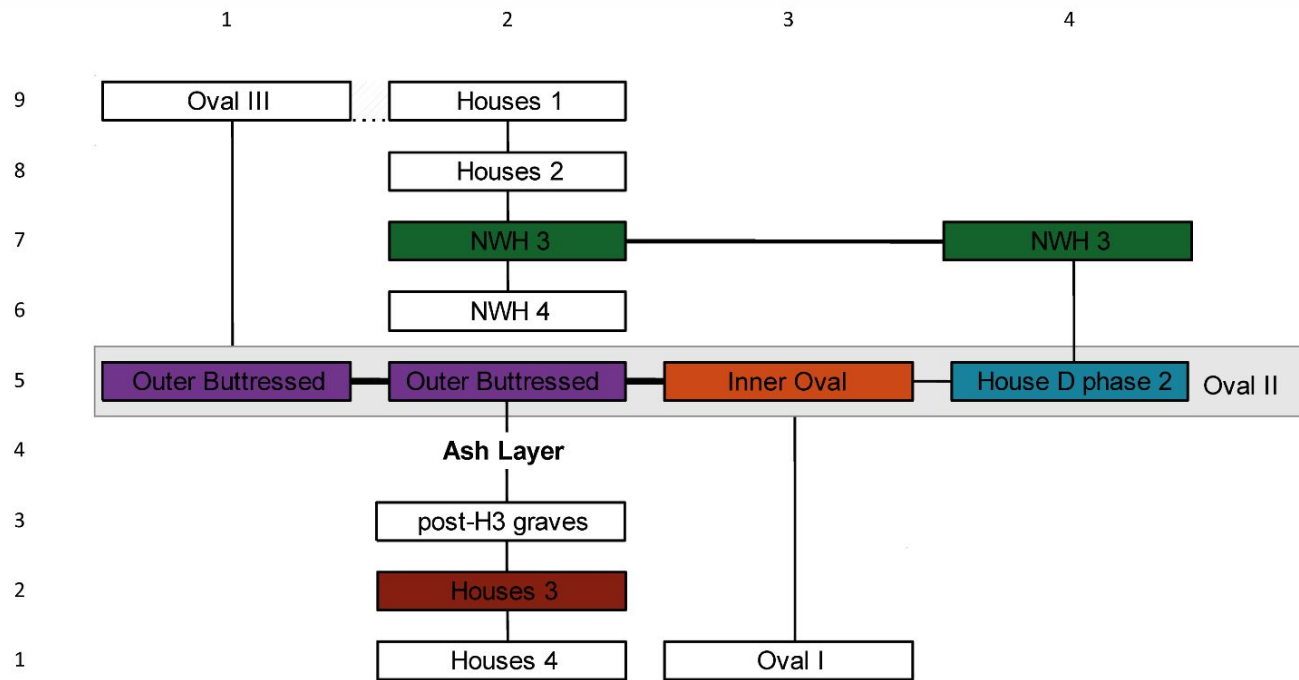

Linking Houses 3 and an "option 2" Oval II

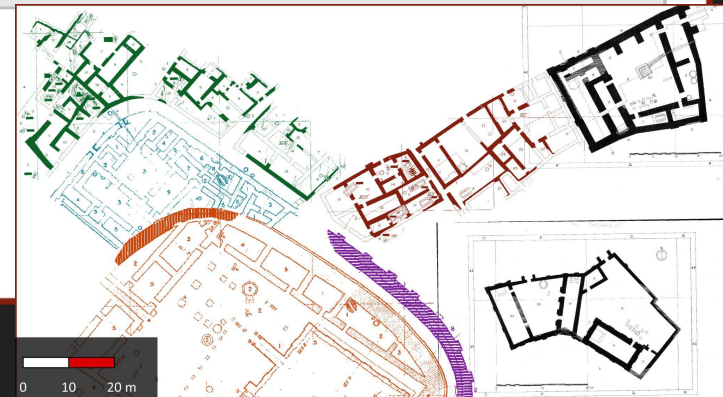
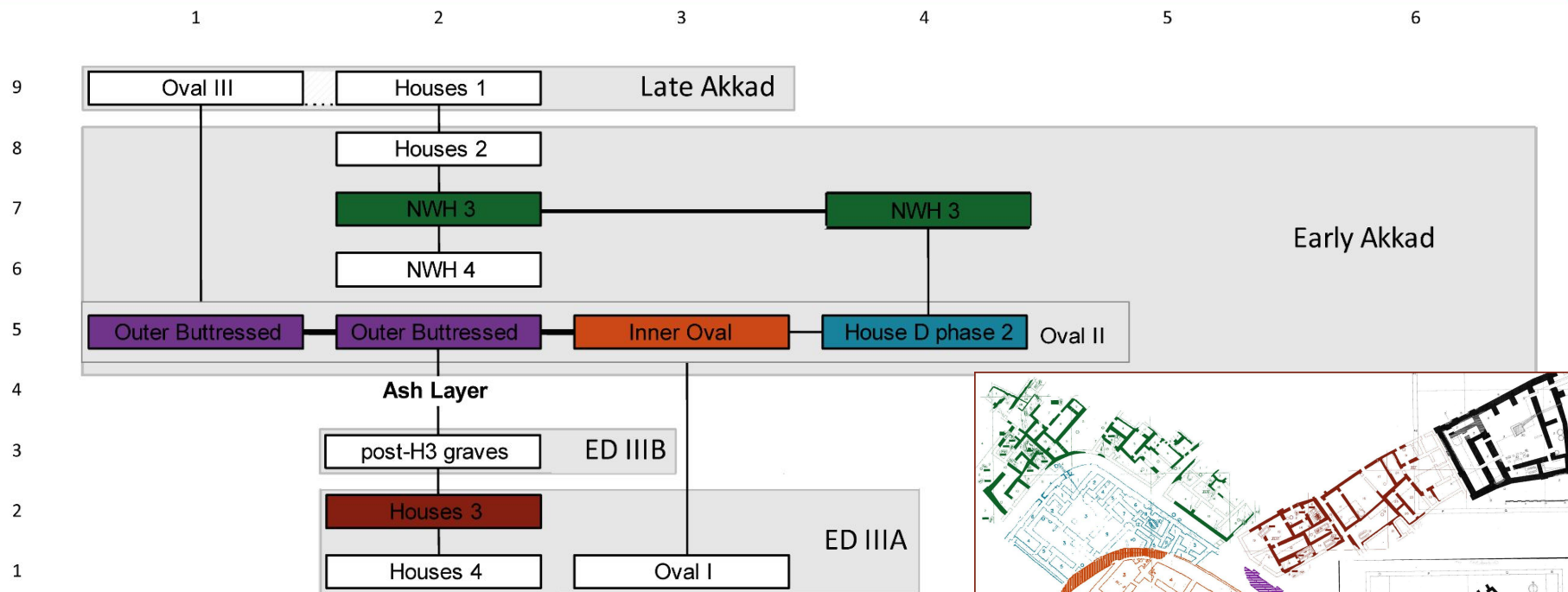

Conclusions



Proposed periods	Houses Level	Subtype A	Other subtypes
ED IIIB to Late Akkad	H1		
ED IIIB to Early Akkad	H2		
	NWH3		
	NWH4		
ED IIIB ?	Post-H3 Graves		
ED IIIA	H3		
ED II to ED III	H4		
ED II to ED IIIA	H5		
	H6		

Conclusions

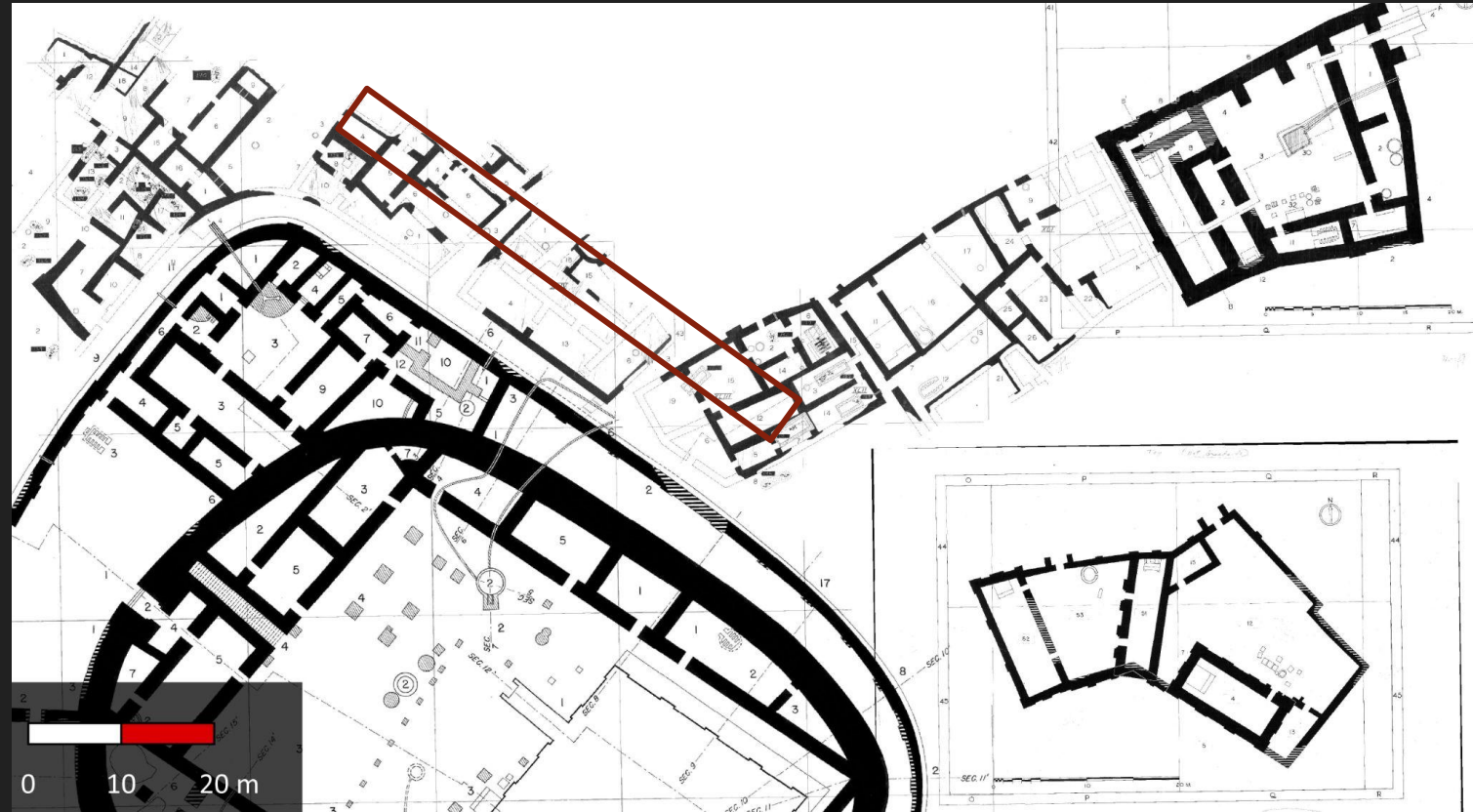

Thank you for your attention

05/03/1932, « P. Delougaz
with the dumb level »

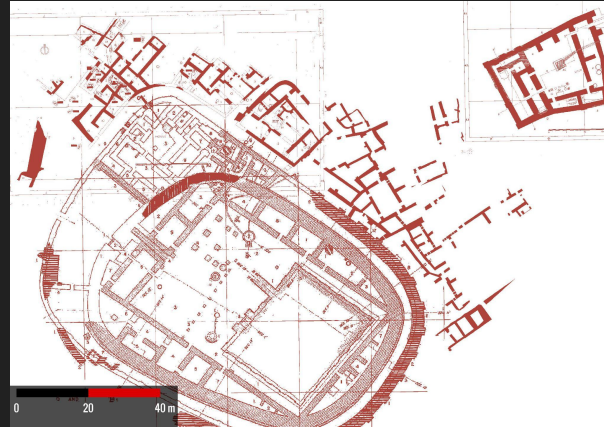

Oval phases from I to III with neighbouring quarters

References (1/3)

Delougaz, Pinhas. 1933. Daybook of the excavations at Khafaje - season 1932-1933. rapport de fouilles. Oriental Institute.

Delougaz, Pinhas. 1935. Daybook of the excavations at Khafaje - Fifth season: 1934-1935. rapport de fouilles. Oriental Institute.

Delougaz, Pinhas. 1940. The Temple oval at Khafājah. Chicago: Oriental Institute.

Delougaz, Pinhas. 1952. Pottery from the Diyala Region. Chicago: University of Chicago Press.

Delougaz, Pinhas, Harold D. Hill, et Seton Lloyd. 1967. Private houses and graves in the Diyala region. Chicago: University of Chicago Press.

Dittmann, Reinhard. 2015. « Genesis and Changing Inventories of Neighborhood Shrines and Temples in the Diyala Region. From the Beginning of the Early Dynastic Period ». P. 71-128 in It's a long way to a historiography of the Early Dynastic Period(s), *Altertumskunde des Vorderen Orients*, édité par R. Dittmann, G. J. Selz, et E. Rehm. Münster: Ugarit-Verlag.

Evans, Jean M. 2007. « The Square Temple at Tell Asmar and the Construction of Early Dynastic Mesopotamia, ca. 2900-2350 B.C.E. » *American Journal of Archaeology* 111(4):599-632.

Gibson, McGuire. 1982. « A Re-Evaluation of the Akkad Period in the Diyala Region on the Basis of Recent Excavations at Nippur and in the Hamrin ». *American Journal of Archaeology* 86(4):531.

Gibson, McGuire. 2011. « The Diyala Sequence : Flawed at Birth ». P. 59-84 in *Between the Cultures: The central Tigris region from the 3rd to the 1st millennium BC. Conference at Heidelberg, January 22nd - 24th, 2009*, *Heidelberger Studien zum alten Orient*, édité par P. A. Miglus et S. Mühl. Heidelberg: Heidelberger Orientverlag.

Henrickson, Elizabeth F. 1981. « Non-religious residential settlement patterning in the late Early Dynastic of the Diyala region ». *Mesopotamia* 16:43-133.

Henrickson, Elizabeth F. 1982. « Functional analysis of elite residences in the late Early Dynastic of the Diyala region ». *Mesopotamia* 17:5-33.

References (2/3)

Marchesi, Gianni, et Nicolò Marchetti. 2011. *Royal Statuary of Early Dynastic Mesopotamia*. Winona Lake: Eisenbrauns.

Margueron, Jean-Claude. 2007. « Un centre administratif religieux dans l'espace urbain à Mari et à Khafadjé (fin DA et Agadé) ». P. 245-77 in *Akh Purattim 2*, édité par J.-C. Margueron, O. Rouault, et P. Lombard. Lyon: MOM.

Margueron, Jean-Claude. 2012. « Notes d'archéologie et d'architecture orientales 16 - De la strate à la « couche architecturale » : réexamen de la stratigraphie de Tuttub/Khafadjé - I - L'architecture civile ». *Syria* 89:59-84.

Margueron, Jean-Claude. 2014. « Notes d'archéologie et d'architecture orientales 17 - De la strate à la « couche architecturale » : réexamen de la stratigraphie de Tuttub/Khafadjé - II - Les temples ». *Syria* 91.

Moon, Jane. 1982. « The Distribution of Upright-Handled Jars and Stemmed Dishes in the Early Dynastic Period ». *Iraq* 44(1):39. doi: 10.2307/4200151.

Palmero Fernández, Monica. 2019. « Shaping the Goddess Inanna/Aštar: Temple Construction, Gender and Elites in Early Dynastic Mesopotamia (ca. 2600–2350 B.C.) ». thèse de doctorat, University of Reading.

Reichel, Clemens D. 2009. *Central Mesopotamia (RG 10) - Second Regional Workshop in Blauberer - February 5-9, 2009*. ARCANE.

Stefanski, Arthur. 2018. « The Material Culture of Early Dynastic and Akkadian Period Conflict: Copper and Bronze Melee Weapons from Khafajah ». *The Canadian Society for Mesopotamian Studies / La Société Canadienne Des Études Mésopotamiennes : Journal* 13:15-40.

References (3/3)

Vallet, Régis. 2001. « Khafadjé ou les métamorphoses d'un quartier urbain au III^e millénaire ». P. 449-61 in *Etudes mésopotamiennes : recueil de textes offerts à Jean-Louis Huot*, Bibliothèque de la Délégation Archéologique Française en Iraq, édité par C. Breniquet et C. Kepinski-Lecomte. Paris: Recherche sur les Civilisations.

Vallet, Régis. 2019. « Le Temple Ovale de Khafajeh: histoire et insertion urbaine ». *Archimède* 9:239-49.

Vallet, Régis. 2020. « Town Planning in Third-Millennium Mesopotamia: A View from the Alluvial Plain ». P. 353-71 in *Circular Cities of Early Bronze Age Syria*, Subartu, édité par C. Castel, J.-W. Meyer, et P. Quenet. Turnhout: Brepols.