



HAL
open science

Multi path and jam resistant antennas for GNSS receivers

Cedric Martel, Guillaume Carrie, Nicolas Capet, Sébastien Rougerie, François Vincent, Thierry Deloues, Franck Letestu, Jérôme Sokoloff, Olivier Pascal

► To cite this version:

Cedric Martel, Guillaume Carrie, Nicolas Capet, Sébastien Rougerie, François Vincent, et al.. Multi path and jam resistant antennas for GNSS receivers. European Test and Telemetry Conference (ETTC) 2011, Jun 2011, Toulouse, France. pp.0. hal-04104531

HAL Id: hal-04104531

<https://hal.science/hal-04104531>

Submitted on 24 May 2023

HAL is a multi-disciplinary open access archive for the deposit and dissemination of scientific research documents, whether they are published or not. The documents may come from teaching and research institutions in France or abroad, or from public or private research centers.

L'archive ouverte pluridisciplinaire **HAL**, est destinée au dépôt et à la diffusion de documents scientifiques de niveau recherche, publiés ou non, émanant des établissements d'enseignement et de recherche français ou étrangers, des laboratoires publics ou privés.



Open Archive Toulouse Archive Ouverte (OATAO)

OATAO is an open access repository that collects the work of Toulouse researchers and makes it freely available over the web where possible.

This is an author-deposited version published in: <http://oatao.univ-toulouse.fr/>
Eprints ID: 5237

To cite this document: Martel, Cedric and Carrie, Guillaume and Capet, Nicolas and Rougerie, Sébastien and Vincent, François and Deloues, Thierry and Letestu, Franck and Sokoloff, Jerome and Pascal, Olivier *Multi path and jam resistant antennas for GNSS receivers.* (2011) In: European Test and Telemetry Conference (ETTC) 2011, 14-16 Jun 2011, Toulouse, France.

Any correspondence concerning this service should be sent to the repository administrator: staff-oatao@inp-toulouse.fr

Multi path and jam resistant antennas for GNSS receivers

Cédric MARTEL¹, Guillaume CARRIE¹, Nicolas CAPET¹, Sébastien ROUGERIE¹, François VINCENT², Thierry DELOUES¹, Franck LETESTU³, Jérôme SOKOLOFF⁴, Olivier PASCAL⁴.

1: ONERA/DEMR - 2 av. Edouard Belin, BP 74025, 31055 Toulouse Cedex 4

2: ISAE - 10 av. Edouard Belin, BP 54032, 31055 Toulouse Cedex 4

3: THALES - 25 rue Jules Védrières, 26027 Valence

4: UPS LAPLACE/GRE - 118 route de Narbonne, 31062 Toulouse

5: CNES - 18 av. Edouard Belin, 31400 Toulouse

Abstract: In GNSS applications, multipath errors and jamming threats are still one of the major error sources or service unavailability in conventional receivers. Antenna array algorithms are introduced as a possible solution to both these threats. Nevertheless, the performances of such techniques are degraded when considering technological defects and especially mutual coupling. To face this limitation, a HIS based antenna array design is presented. This design aims at minimizing the array mutual coupling coefficients while not increasing the size of the array.

Keywords: GNSS, CRPA, mutual coupling, antenna, HIS

1. Introduction

In Global Navigation Satellite Systems (GNSS) applications, multipath errors are still one of the major error sources in conventional receivers. Furthermore, due to low SNR, single antenna GNSS receivers are susceptible to jamming threats. In the last two decades, the use of adaptive antenna arrays to mitigate the detrimental effects of jamming upon GNSS receivers has gained significant interest in the signal processing community. More recently, antenna array algorithms have also shown their ability in mitigating the GNSS multipaths. Nevertheless, the performances of antenna array are strongly affected by technological defects such as channel mismatch or mutual coupling. The first part of this paper will therefore analyze the impact of mutual coupling, on antenna array performances. These defects can be partially mitigated by signal processing techniques. But the induced computational load can quickly become crippling.

The second part of the paper will focused on the reduction of the mutual coupling at the RF level. Mutual coupling between closely spaced elements is complex and may come from various contributions such as the direct radiation through the air, surface waves propagating on the antenna plane and also waves propagating inside dielectric materials. High impedance surfaces (HIS) are proposed to isolate the radiating elements of the array. The integration of the HIS is optimised in an array of cavity backed patch elements. The decoupling capability

of the HIS is validated experimentally with the manufacture and test of a demonstrator.

2. Impact of mutual coupling on antenna array performances

2.1. Data Model

Consider an array of m sensors illuminated by one useful and one jamming signals (respectively ‘ u ’ and ‘ j ’), the output can be written:

$$\mathbf{y}(t) = \mathbf{a}_u \cdot u(t) + \mathbf{a}_j \cdot j(t) + \mathbf{n}(t) \quad (1)$$

where $\mathbf{n}(t)$ is a White Gaussian Noise. \mathbf{a}_u , \mathbf{a}_j denote the steering vectors of the array. Single sensor radiation patterns are included into the steering vectors.

The complex weight vector \mathbf{w} is controlled in phase and amplitude by the array processor to provide the Controlled Radiation Pattern Antenna (CRPA) output $y_s(t)$:

$$y_s(t) = \mathbf{w}^H \mathbf{y}(t) \quad (2)$$

where the superscript H stands for Hermitian. All the incoming signals are assumed **uncorrelated**, the auto-correlation matrix \mathbf{R} of the array is then defined as follows:

$$\mathbf{R} = \mathbf{E}(\mathbf{y}\mathbf{y}^H) = P_u \mathbf{a}_u \mathbf{a}_u^H + P_j \mathbf{a}_j \mathbf{a}_j^H + \sigma^2 \mathbf{I} \quad (3)$$

where P_u , P_j denote the powers of the incoming signals, σ^2 is the noise power and \mathbf{I} the m order identity matrix.

Consider now that mutual coupling exists between the array sensors. Under the narrow band assumption, the array output model is modified as:

$$\mathbf{y}(t) = \mathbf{C} \times (\mathbf{a}_u \cdot u(t) + \mathbf{a}_j \cdot j(t)) + \mathbf{n}(t) \quad (4)$$

where \mathbf{C} is the coupling matrix. The coefficients of \mathbf{C} are a function of the load impedance, single sensor impedance and array mutual impedance [1]. Usually, the diagonal coefficients of \mathbf{C} are close to unity, and the non diagonal coefficients are very close to the ones of the Scattering matrix \mathbf{S} .

To analyze the impact of (4) on the array performances, a 2×2 square antenna array with half-wavelength spaced patches has been simulated with HFSS.

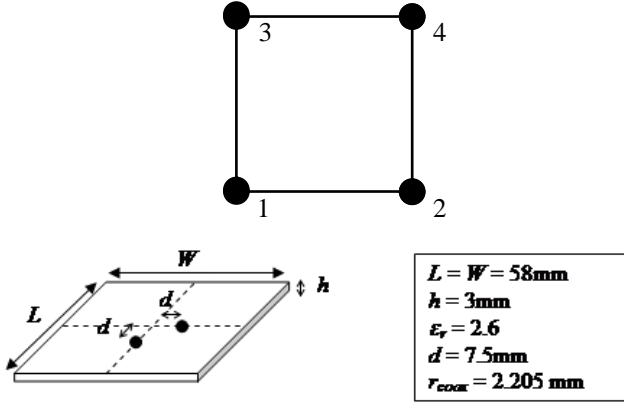

Figure 1: Square array configuration and patch design

The array configuration and the patch design are depicted on Figure 1. The obtained mutual coupling coefficients for the L1 GNSS band are illustrated on Figure 2.

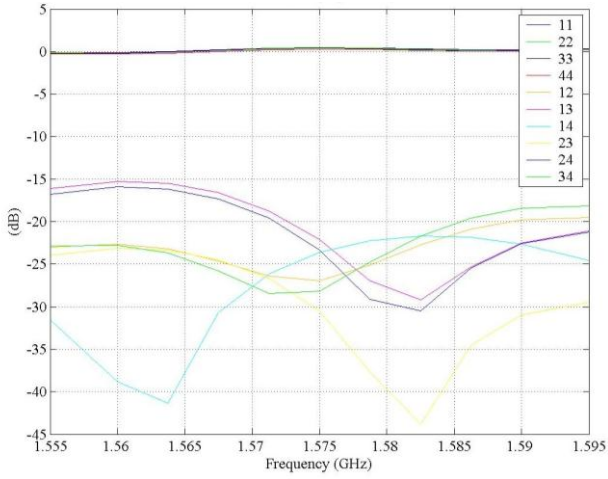

Figure 2: Array mutual coupling coefficients

From Figure 2, it is clear that the narrow band assumption is no more valid on a 20 MHz bandwidth and the array output model (4) has to be replaced by the wide band model:

$$\mathbf{y}(f) = \mathbf{C}(f) \times (\mathbf{a}_u(f) \cdot u(f) + \mathbf{a}_j(f) \cdot j(f)) + \mathbf{n}(f) \quad (5)$$

2.2. Mitigating Jammers

Due to low SNR (lower than -30dB with a 20MHz bandwidth for GPS BPSK(10) signals), \mathbf{R} is assumed to contain interference plus noise only. Thus we can write:

$$\mathbf{R} \approx P_j \mathbf{a}_j \mathbf{a}_j^H + \sigma^2 \mathbf{I} \quad (6)$$

Classically in the GNSS context, adaptive CRPA are designed so as to receive signals from as many satellites as possible while rejecting strong interferers. The most widely used solutions consist in linearly constrained power minimization techniques. One aims at minimizing the array output power while trying to maintain the interference free case beampattern:

$$\min_{\mathbf{w}} \mathbf{w}^H \mathbf{R} \mathbf{w} / \mathbf{w}^H \mathbf{w}_0 = 1, \quad (7)$$

where \mathbf{w}_0 is the weight vector design for the desired beampattern. The well known solution is given by:

$$\mathbf{w} = \frac{\mathbf{R}^{-1} \mathbf{w}_0}{\mathbf{w}_0^H \mathbf{R}^{-1} \mathbf{w}_0}. \quad (8)$$

Due to their low power, GNSS signals will not be cancelled by this technique.

The equation (8) can either be used to design beamformers if the useful signal Direction Of Arrival (DOA) are known a priori, or nullformers if no prior information is available. The most popular application of this latest technique, named Power Inversion [2] [3], is obtained with $\mathbf{w}_0 = [1 \ 0 \ \dots \ 0]^T$ and simply consists in minimizing the output power of the array while not weighting a reference sensor. Note that in the interference free case, the radiation pattern of the array is the same as the reference sensor.

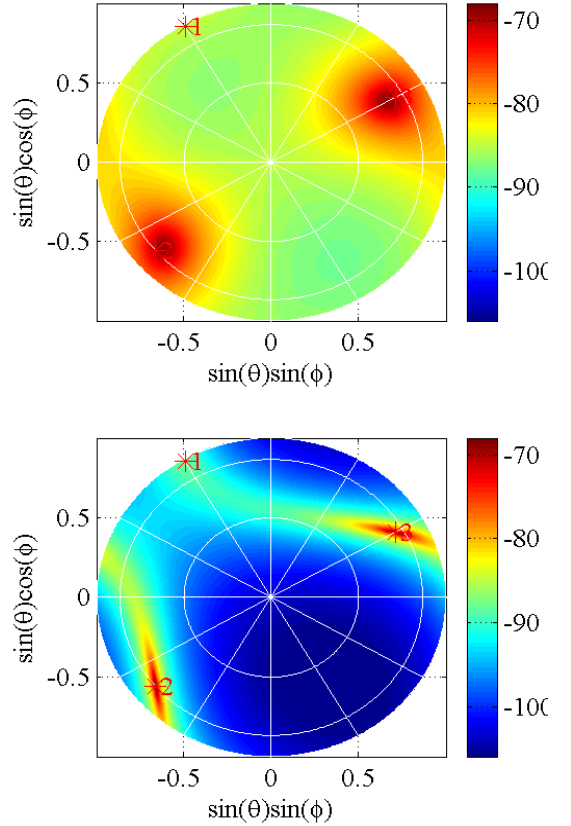

Figure 3: Capon space power spectrum estimated by a coupled array (top) and an uncoupled array (bottom)

Based on (5), a scenario involving 3 broadband strong jammers has been simulated. The Capon space power spectrum estimated by the array is illustrated on Figure 3 with or without taking into account the mutual coupling. The stars on Figure 3 represent the jammers DOA. Without the coupling effect, the maximum power DOA estimated by the array corresponds to the true jammers DOA. But when coupling is present, the maximum power DOA are biased with respect to the jammers DOA. Furthermore, the jammers appear to arrive from a spread area and not from a discrete DOA. This latest effect contributes to considerably increase the rank of the subspace of a powerful jammer, and then reduces the rejection capacity of the array.

This effect has already been observed and detailed in [4] when technological defects except coupling are simulated. To counteract the increase of the jammers subspace rank, a choice has been made in [4] to add temporal degrees of freedom to the array (see Figure 4). The optimal Space Time Adaptive Processor (STAP) for GNSS applications has also been derived in [4], it enables to partially compensate the technological defects including mutual coupling, but the price is a significant increase of the algorithm computational load.

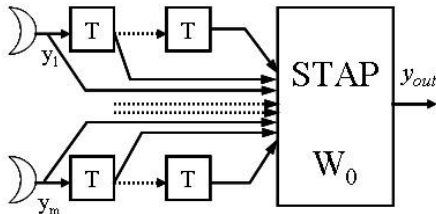

Figure 4: STAP array principle

2.3. Mitigating GNSS Multipaths

As already mentioned, in the GNSS context, the power of the incoming signals is usually much lower than the receiver noise level. Thus, if we want to be able to see the GNSS signals and especially their multipaths, we first need to correlate the incoming signal with the reference local code.

Classical adaptive algorithms, such as the ones of previous chapter, have tested on post-correlation incoming signals. The results obtained with these solutions are quite mitigated [5] [6]. Indeed, on the one hand, the small size of the array implies a low space resolution, and on the other hand, the **correlation** between the Line Of Sight (LOS) signal and the multipaths strongly degrade the performance of classical adaptive high resolution algorithms. This latest effect being the most significant one.

Then, in [5] a Space Alternated Generalized Expectation (SAGE) algorithm has been tested with an antenna array in order to reduce the estimation error of the delay of the LOS signal. With 2 more dimensions (Doppler and time-delay), SAGE is able to discriminate the sources even in the presence of close multipaths. However, SAGE is hardly implemented in real time due to the memory requirements and computational cost of the algorithm.

In order to take the advantages of SAGE with more reasonable hardware requirements, a new implementation of SAGE has been proposed and detailed in [6]. This new implementation is mainly based on the STAP multi-correlators array (see Figure 5). With this method, we can strongly reduce the size of the signal and thus, the complexity of the algorithm. Monte Carlo simulations tend to show similar performance between classical SAGE implementation and the SAGE / STAP multi-correlators algorithm.

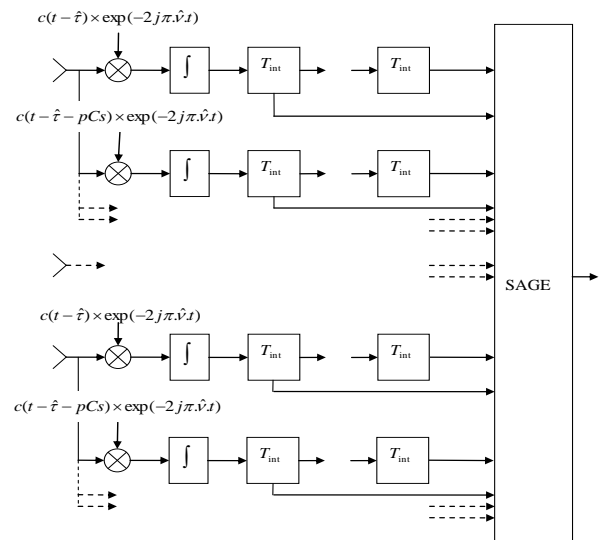

Figure 5: STAP multi-correlators

Nevertheless, when mutual coupling is introduced in the simulations, the algorithm performances degrade as the estimated DOA are biased. Such an example, Figure 6 depicts a comparison between LOS DOA and estimated DOA through the SAGE / STAP multi-correlators algorithm. The DOA biases can be higher when considering GNSS signal multipaths whose received power is even weaker.

Once again, the mutual coupling effect can be partially mitigated by signal processing calibration techniques (e.g.: based on a coupling matrix model and prior knowledge of LOS DOA) but the price is still an increase on the computational load and complexity of the algorithm.

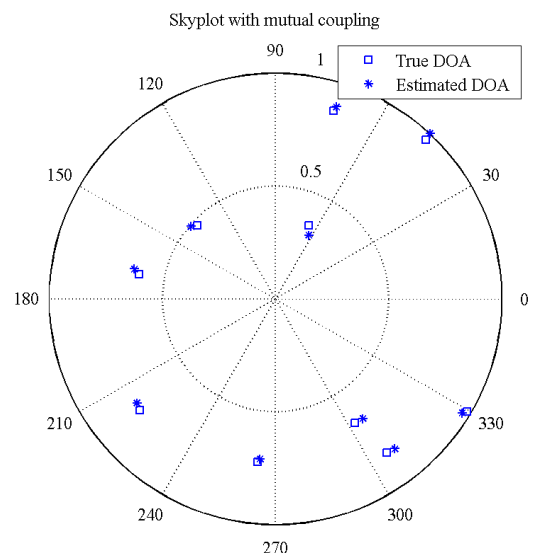

Figure 6: DOA finding with a coupled array

3. Mitigation of inter element mutual coupling

It has been shown in previous section that antenna array algorithms are a possible solution to both GNSS

multipaths and jamming threats. Nevertheless, the performances of such techniques are degraded due to inter sensor mutual coupling. Signal processing techniques can be envisioned to mitigate these effects but the price is an increase of the computational load of already computational demanding algorithms. Then, the aim of this section is to propose an array genuinely designed to minimize inter sensor mutual coupling.

3.1. Metamaterials as isolating structures

Metamaterials structures such as EBG or others artificial magnetic conductors are attractive to reduce mutual coupling between the elements of an array [1].

The metamaterial structure we propose to investigate is made of a thin dielectric slab on which small patch conducting elements are printed on both bottom and top faces. The close proximity of the patches and the overlapping surface produced by the lateral layout of the patches generate a strong capacitive effect. The dielectric slab is placed above a ground plane. Some dielectric material separates the dielectric slab and the ground plane.

Metallized vias connecting the printed elements to the ground plane are commonly used. Although these vias may in some cases enhance the isolating performance of the metamaterial surface, their presence is not always necessary to achieve a decoupling characteristic.

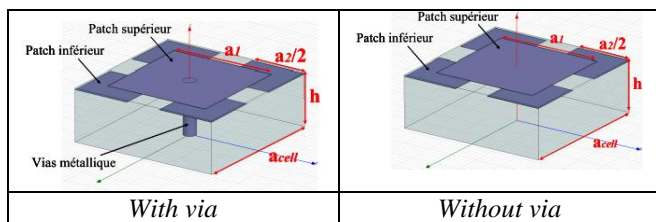

Figure 7: High impedance surface unit cell

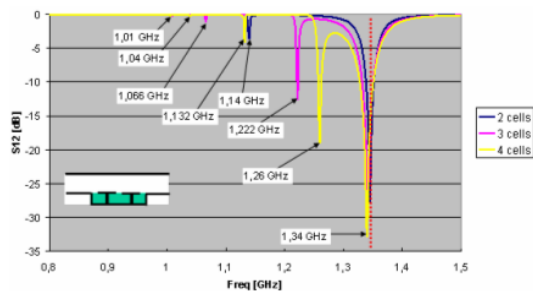

Figure 8: Transmission coefficient of a TEM wave in a guide containing a HIS with vias

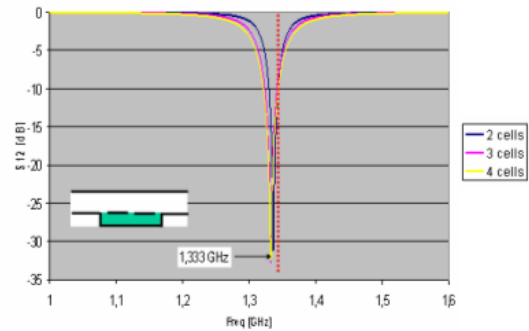

Figure 9: Transmission coefficient of a TEM wave in a guide containing a HIS without vias

3.2. HIS integration in a GNSS array

3.2.1. Simulation

The EM simulation of small GNSS array with HIS resonator is a difficult task due to the multi scale element features: the size of the radiating element is about half a wavelength whereas the size of the HIS unit cell is the order of $1/30$ of a wavelength. Moreover, the large number of HIS cells imposes large amount of computational power for a full wave analysis to take place. For this reason, only a partial theoretical design optimisation of the array has been carried out with the HIS. A complete optimisation has been performed experimentally as explained in the following sections.

3.2.2. Description of demonstrator

The radiating elements of the array consist of patches in cavities. Each patch has two vertical probes, which can be fed in phase quadrature to generate the appropriate circularly polarised radiation patterns.

A metallic support with cavities for the radiating elements and the HIS resonator is used. On the metallic support, the cavities have no bottom ground planes. With this setup, both the radiating elements and the HIS resonators can be inserted from underneath the structure in a modular fashion.

To obtain sufficient space to insert the HIS resonator between the radiating elements, it is necessary to use a material with a relatively high dielectric constant as a substrate for the patches. For this reason, a ceramic material ($DK \sim 8.2$) has been chosen as the patch substrate. For a practical implementation of the manufacture process, the patch has been printed on a thin substrate (0.127 microns) and then glued on the ceramic block. A small ground plane is present at the base of the ceramic block.

The HIS resonator has been made by printing electrically patches on either side of a thin low loss PTFE substrate of relative permittivity of 2.2. The thickness of the substrate is 0.127 mm. The HIS substrate has been fixed with nylon screws on the top of the metallic support at the dedicated locations. A metallic plate can be added to the metallic

support from underneath to form the HIS bottom ground plane. The dielectric material inside the HIS cavity is air. In addition, some adjusting parts in the shape of a ring can be inserted between the metallic support and the HIS bottom ground plane. With a set of these adjusting parts of different sizes, the height of the HIS resonator can be changed. Experimental tuning of the HIS resonant frequency position can then be performed by adding or subtracting the adjusting parts.

The dimensions of the array are as follows:

- distance inter element: 112 mm (centre to centre)
- cavity size: $60 \times 60 \times 18$ mm
- patch size: 35.5×35.5 mm
- HIS width: 24 mm
- HIS cavity height: adjustable from 12 mm onwards
- Metallic support: 350×240 mm

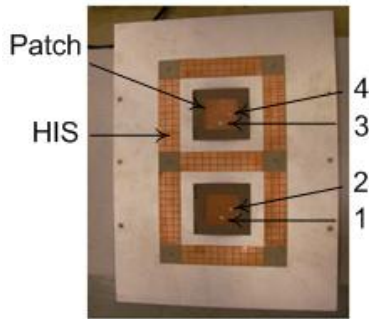

Figure 10: Array with HIS resonator

3.2.3. Test results and analysis

S parameter measurements have been performed on the 2 element array with and without the HIS resonator. A 4 port network analyser has been used to carry out the measurements. The test of the array without the HIS is used as a reference (Figure 11).

In the reference case, the array is well matched around the frequency 1.207 GHz with a -10 dB bandwidth of 37 MHz. However, coupling levels with a maximum value of -14 dB can be observed in the operating band.

In the case where the HIS is added around the radiating elements, strong interactions take place between the patches and the HIS due to the short distance separating them. In order to overcome the lack of accurate simulation analysis and the tolerance of manufacture, an optimisation of the array has been carried out experimentally. The optimisation has consisted of tuning the HIS resonant frequency to make it coincide with the patch resonance. This was achieved by varying the cavity height of the HIS resonator with the help of some adjusting ring metallic parts.

Optimum performance have been found for a HIS cavity height of 17 mm. The addition of the HIS resonator has a remarkable effect on the S parameter results (Figure 12).

First of all, the patch resonant frequency is shifted 17 MHz toward higher frequencies: 1.224 GHz versus 1.207 GHz in the reference case. Secondly, the matching of the elements has been degraded in presence of the HIS. Although a slight unbalance between the S11 and S33 is noticeable, the matching of the elements remains acceptable for a significantly large frequency band. The -10 dB bandwidth is similar with and without the HIS resonator. Thirdly, the element mutual coupling has been significantly reduced. With the HIS, the maximum coupling level is about -17 dB and can be as low as -37 dB in some part of the operating band. The impact of the HIS is noticeable with the resonance effect at 1.21 GHz.

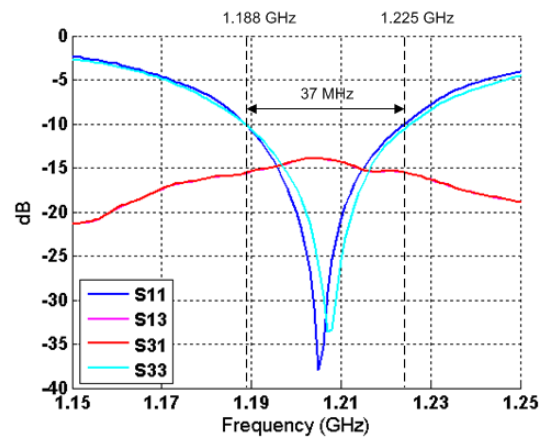

Figure 11: Measured S parameters of the 2 element array without HIS resonators

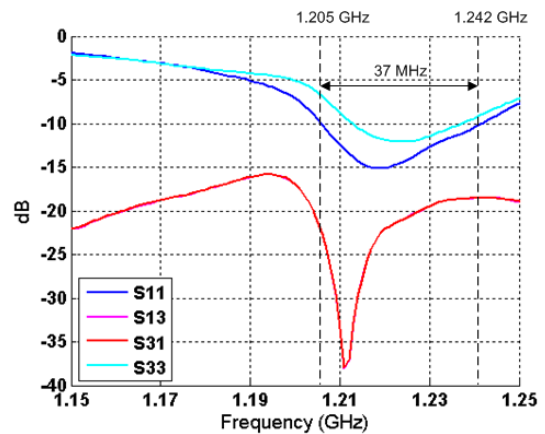

Figure 12: Measured S parameters of the 2 element array with HIS resonators

4. Conclusion

In GNSS applications, multipath errors and jamming threats are still one of the major error sources or service unavailability in conventional receivers. Antenna array algorithms are introduced as a possible solution to both these threats. Nevertheless, the performances of such techniques are degraded when considering technological defects and especially mutual coupling. To face this limitation, a HIS based antenna array design is presented.

This design aims at minimizing the array mutual coupling coefficients while not increasing the size of the array.

5. Acknowledgement

The authors would like to thank Maryse Lopez (ONERA/DEMUR) and Olivier Pigaglio (LAPLACE) for their precious help with the measurement of the antenna prototype.

6. References

- [1] T. Svantesson, "Modeling and Estimation of Mutual Coupling in a Uniform Linear Array of Dipoles", Proc. ICASSP 1999, Phoenix, Az, March 1999.
- [2] D-J. Moelker, Dr. Y. Bar-Ness, "An Optimal Array Processor for GPS Interference Cancellation", 15th AIAA/IEEE Digital Avionics Systems Conference, Atlanta, Oct. 1996.
- [3] R.L. Fante, J.J. Vaccaro, "Wideband Cancellation of Interference in a GPS Receive Array", IEEE Transactions on Aerospace and Electric Systems, vol. 36, n° 2, april 2000.
- [4] G. Carrie, F. Vincent, T. Deloues, D. Pietin, A. Renard, F. Letestu: "Optimal STAP Algorithms to GNSS Receivers", Proc. European Navigation Conference 2006, Manchester International Convention Centre, May 2006.
- [5] S. Rougerie, A. Konovaltsev, M. Cuntz, G. Carrie, L. Ries, F. Vincent, R. Pascaud: "Comparison of SAGE and Classical Multi-Antenna Algorithms for Multipath Mitigation in Real-World Environment", Proc. NAVITEC 2010, Noordwijk, The Netherlands, December 2010.
- [6] S. Rougerie, G. Carrie, L. Ries, F. Vincent, R. Pascaud, E. Corbel, M. Monnerat : "Multipath mitigation methods based on antenna array", Proc. ION ITM 2011, San Diego, CA, January 2011.
- [7] F. Yang, Y. Rahmat-Samii: "Microstrip antennas integrated with electromagnetic band gap (EBG) structures: a low mutual coupling design for array applications", IEEE Transactions on Antennas and Propagation, vol. 51, No. 10, October 2003.
- [8] D. Sievenpiper, PhD thesis, University of California, 1999.
- [9] N. Capet, C. Martel, J. Sokoloff, O. Pascal: "Reduction of the mutual coupling between two adjacent patches using various ideal high impedance surface positionings", European Conference on Antennas and Propagation, Berlin, March 2009.
- [10] N. Capet, C. Martel, J. Sokoloff, O. Pascal: "Study of the behaviour of a two layered high impedance surface with electromagnetic band gap", European Conference on Antennas and Propagation, Barcelona, April 2010.

7. Glossary

CRPA: Controlled Reception Pattern Antenna

DOA: Direction of Arrival

GNSS: Global Navigation Satellite System

HIS: High Impedance Surface

LOS: Line Of Sight

SAGE: Space Alternated Generalized Expectation

STAP: Space Time Adaptive Processor