



**HAL**  
open science

## When phonology outranks syntax: postponed relative pronouns in Pindar

Nicolas Bertrand

► **To cite this version:**

Nicolas Bertrand. When phonology outranks syntax: postponed relative pronouns in Pindar. *Glossa: a journal of general linguistics* (2021-..), 2023, 8 (1), pp.1-41. 10.16995/glossa.9842 . hal-04101061

**HAL Id: hal-04101061**

**<https://hal.science/hal-04101061v1>**

Submitted on 19 May 2023

**HAL** is a multi-disciplinary open access archive for the deposit and dissemination of scientific research documents, whether they are published or not. The documents may come from teaching and research institutions in France or abroad, or from public or private research centers.

L'archive ouverte pluridisciplinaire **HAL**, est destinée au dépôt et à la diffusion de documents scientifiques de niveau recherche, publiés ou non, émanant des établissements d'enseignement et de recherche français ou étrangers, des laboratoires publics ou privés.



Distributed under a Creative Commons Attribution 4.0 International License



Bertrand, Nicolas. 2023. When phonology outranks syntax: postponed relative pronouns in Pindar. *Glossa: a journal of general linguistics* 8(1). pp. 1–41. DOI: <https://doi.org/10.16995/glossa.9842>



Open Library of Humanities

## When phonology outranks syntax: postponed relative pronouns in Pindar

Nicolas Bertrand, Université Côte d'Azur, UMR 7320: BCL, CNRS, UCA, FR, [nicolas.bertrand@univ-cotedazur.fr](mailto:nicolas.bertrand@univ-cotedazur.fr)

In ancient Greek, relative pronouns are, as a rule, subject to *wh*-movement and obligatorily surface at the left edge of the relative clause. However, the archaic poet Pindar sometimes allows material belonging to the relative clause to appear in front of the relative pronoun, which is then postponed within its clause. In this paper, I survey all relative clauses in the surviving texts by Pindar and study the possible differences in semantics and syntax between relative clauses with initial and postponed relative pronouns, which turn out to be indistinguishable in both respects. I suggest that postponed relative pronouns do move syntactically to the Spec of their relative clause but are then optionally treated as postpositive words and surface in second position in the relative clause. Phonological arguments, based on the distributional properties of postpositive words and on the metrical makeup of Pindar's texts, are put forward to show how postponed relative pronouns select a host at the left edge of the relative clause and incorporate phonologically to it. The informational status of relative pronouns as ratified (given) topics triggers their phonological demoting, which turns them into postpositive words, a regular process in ancient Greek. Approaching the position of relative pronouns as a conflict between syntactic and (informationally driven) phonological alignment explains why Pindar's strategy for relativization remained rare in ancient Greek and eventually disappeared: It took one specific poetic genre to allow phonology to outrank syntax.

*Glossa: a journal of general linguistics* is a peer-reviewed open access journal published by the Open Library of Humanities. © 2023 The Author(s). This is an open-access article distributed under the terms of the Creative Commons Attribution 4.0 International License (CC-BY 4.0), which permits unrestricted use, distribution, and reproduction in any medium, provided the original author and source are credited. See <http://creativecommons.org/licenses/by/4.0/>.

**OPEN ACCESS**



## 1 Introduction: What is that pronoun doing here?

Word order is the outcome of competing components of grammar: syntax, information structure, and phonology. Ancient Greek (AG) is a case in point: as a discourse-configurational language, AG linearizes constituents to express information structure (Dik 1995; Matic' 2003a; Dik 2007; Bertrand 2009; 2010); still, some aspects of AG word order are purely syntactic, in particular *wh*-movement (Bertrand & Faure 2022). In addition, AG displays word order phenomena at the phonological level (Agbayani & Golston 2010), which can be reconstructed through careful analysis of the position of clitics (Fraenkel 1932; 1933; 1964; 1965; Scheppers 2011; Goldstein 2015) and, in verse, the interplay between syntax and metrical structures (Devine & Stephens 1994). Yet, it is not always easy to sort out which component of grammar is responsible for any given configuration.

Relative clauses (RCs) are revealing in that respect: While in AG the relative pronoun (RP), as a rule, undergoes *wh*-movement and appears at the left edge of the RC, the archaic poet Pindar sometimes allows it to occur after material belonging to the RP. Such a strategy for relativization is not unheard of across languages, although quite rare (de Vries 2002: 37; 2005: 21–23), but it is problematic in terms of AG syntax, as we will see. What are the factors, then, that license the postponement of the RP? Are they syntactic in nature, or do they depend on other components of the grammar of AG?

After providing some background and presenting the issue in more detail in section 2, I will offer a comprehensive overview of the data (Section 3). Then I will show that RCs, whether the RP is initial or not, are semantically and syntactically identical (Section 4), before offering an explanation to the problem and proposing that, in Pindar, phonology may sometimes outrank syntax (Section 5).

## 2 Background

### 2.1 Pindar's language

Before we get to the issue at hand, a short note on Pindar's language is in order. Pindar was an archaic Greek poet (522/518–c. 438 BCE), born in the region of Thebes. His dialect was Beotian (a form of Aeolian) but, as a writer of choral lyric poetry, he used a literary form of the Dorian dialect, mixed with Ionian (Homeric) and Aeolian (mostly Lesbian) dialectal forms, a standard practice in his poetic tradition.<sup>1</sup> His surviving works consist of 46 epinician odes (celebratory poems for the winners of various Panhellenic games), ranging from 498 to c. 444 BCE, and fragments of other poems of various poetic genres over the same period of time. Since

---

<sup>1</sup> AG was dialectally very diverse (Buck 1928; Bechtel 1963); some (mostly standardized) dialects were associated with a literary genre (Verdier 1972; Silk 2010; Tribulato 2010; Miller 2014).

ancient times, his language has been famous for its intricacy, especially in terms of word order.<sup>2</sup> However, even when Pindar’s language bended the grammatical rules of AG, it was not to the point of breaking them entirely, which would have resulted in meaninglessness; its grammatical features should be studied as parts of a linguistic system with its own coherence, rather than oddities or poetic licenses against the background of prose. Moreover, the metrical design of Pindar’s poems provides several clues to understand the prosody of AG, which is mostly lost in prose texts. Those characteristics make Pindar’s language worthy of studying from a linguistic perspective, although most of the literature focuses on its stylistic features (with the exception of e.g. des Places 1947; Lauer 1959; Hajdú 1989; Hummel 1993; 2001).

## 2.2 Ancient Greek relative clauses

RCs in AG, including most of those found in Pindar, are rather straightforward from an Indo-European point of view (Adams 1972; Perna 2013). They are built with a RP, which is an inflected complementizer with the dual function of marking both the subordinate relation to the matrix clause and the syntactic function of the referent within the RC. This RP is followed by the rest of the RC. The head of the RC (its “antecedent”) is a DP or pronoun, which can be external with the RC postposed to it (1), external with a preposed RC (2), internal (3) or null (4).

- (1) Kōphòs anér<sub>i</sub> tis<sub>i</sub>, [ hòs<sub>i</sub> Hērakleí  
 mute:NOM.SG man:NOM.SG INDF:NOM.SG REL:NOM.SG Heracles:DAT.SG  
 stóma mē peribállei ].<sup>3</sup>  
 mouth:ACC.SG NEG embrace:PRS.3s  
 “a man is mute who does not have Herakles on his lips” (P. 9.87)
- (2) [ Hoísi<sub>i</sub> dè Phersephónā poinān palaiou̇  
 REL:DAT.PL CONN Persephone:NOM.SG payment:ACC.SG ancient:GEN.SG  
 péntheos | déksetai ], es tôn hūperthen hálion keínōn<sub>i</sub>  
 grief:GEN.SG receive:FUT.3s to ART:ACC.SG above sun:ACC.SG DEM:GEN.PL  
 enátōi étei | andidoī psūkhàs pálin.  
 ninth:DAT.SG year:DAT.SG give.back:PRS.3s soul:ACC.PL again  
 “the ones for whom Persephone receives the payment of her ancient grief, she brings  
 back again their souls to the sun above on the ninth year” (fr. 133.1–3)

<sup>2</sup> Dionysios of Halicarnassus, a literary critic of the 1<sup>st</sup> century BCE, compares Pindar’s words to scattered rough stones on a construction site, in *De compositione verborum* 22 (Usener & Radermacher 1929: 6.96).

<sup>3</sup> Examples are quoted according to the text established by Maehler & Snell (1980). For the references, the following abbreviations are used: O. = Olympian odes, P. = Pythian odes, N. = Nemean odes, I. = Isthmian odes, fr. = fragments. The glosses are slightly simplified to enhance readability (gender is mentioned only when necessary; verbs are by default indicative and active unless specified otherwise). RCs are delimited by square brackets in bold face; RPs are in bold face as well. The vertical bar ‘|’ indicates line-end.

- (3) [ **Hósai**<sub>i</sub> t' eisìn epikhōrion kalôn ésodoi<sub>i</sub> ] |  
 REL:NOM.PL CONN be:PRS.3p local:GEN.PL good:GEN.PL opportunity:NOM.PL  
 tetólmāke.  
 dare:PRF.3s  
 “every opportunity there is for local excellence, he has dared to do” (P. 5.116–117)
- (4) En dè peírāi telos | diapháinetai [ **hōn**  
 in CONN trial:DAT.SG accomplishment:NOM.SG appear:PRS.3s REL:GEN.PL  
 tis eksokhōteros génētai ].  
 INDF:NOM.SG best:NOM.SG become:SBJV.PRS.3s  
 “in trial the accomplishment appears, of that in which one is the best” (N. 3.70–71)

Such strategies for relativization are standard in AG, as is the possibility of relativizing a head extracted from a subclause within the RC itself, as in (5), where the RP *hōi* is the object of the participle *enkathízōn* ‘sitting in’, not of the finite main verb *eúthūne* ‘he set straight’.<sup>4</sup>

- (5) kai thrónos<sub>i</sub> [ **hōi**<sub>i</sub> pote Krētheídās |  
 and throne:NOM.SG REL:DAT.SG once son.of.Kretheus:NOM.SG  
 enkathízōn hippótāis eúthūne laoís  
 sit.in:PTCP.PRS.NOM.SG horseman:DAT.PL direct:IMPF.3s people:DAT.PL  
 díkās ].  
 judgement:ACC.PL  
 “and the throne, in which the son of Kretheus used to seat to set the judgements  
 straight for his horsemen people (lit. ‘in which being seated the son of Kretheus once  
 set the judgements straight’).” (P. 4.152–153)

### 2.3 Problematic relative clauses in Pindar

However, not all RCs in Pindar behave as expected and one comes across puzzling instances. In (6), for instance, the RP shows up after material belonging to the RC itself: *Aiétā* ‘Aietas’ is a genitive extracted from the DP *zamenés país* ‘holy child’.

- (6) kai tò Mēdeíās épos<sub>i</sub> ankomísai | hebdómāi  
 and ART:ACC.SG Medeia:GEN.SG word:ACC.SG carry.out:AOR.INF 7th:DAT.SG  
 kai sùn dekátāi geneâi Théraion<sub>i</sub>, [ Aiétā  
 and with 10th:DAT.SG generation:DAT.SG of.Thera:ACC.SG Aietas:GEN.SG  
 tó<sub>i</sub> pote zamenés | país apépneus’ āthanátou  
 REL:ACC.SG once holy:NOM.SG child:NOM.SG blow:AOR.3s immortal:GEN.SG

<sup>4</sup> This extraction out of a syntactic island, also attested in Latin, is traditionally called “*Relative Verschränkung*” (Devantier 1886; Kühner & Gerth 1890–1904: §557; Danckaert 2012: 124–135, with bibliography).

stómatos, déspoina Kólkhōn]  
 mouth:GEN.SG queen:NOM.SG Colchian:GEN.PL

“and to carry out the word of Medeia, at the 17th generation, [the word] spoken at Thera, which Aietas’ holy child once blew from her immortal mouth, the queen of the Colchians.” (P. 4.9–11)

Descriptively, I will call those pronouns “postponed RPs” (henceforth PRPs), as opposed to the “initial RPs” (henceforth IRPs) occurring elsewhere.

What is surprising about PRPs is their scarcity, as they are found in only 44 (11.89%) of all 370 RCs in Pindar. They are also problematic from a syntactic point of view. Adopting a cartographic view (split CP: Rizzi 1997), Faure (2021b) shows that RPs occupy the highest position in the left-periphery of the RC (7).

(7) Structure of the CP left periphery (after Faure 2021b: 160)

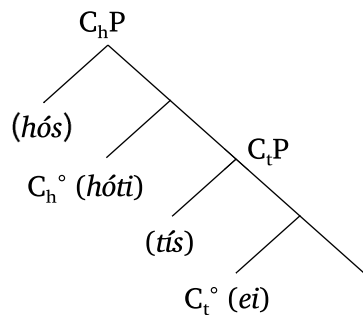

Faure’s analysis of the CP left periphery dwells on the impossibility of extracting anything out of RCs (including raising to object, the so-called “prolepsis”, of NPs complementing a verb), in contrast to other types of complement clauses (Faure 2021b: 160–165). For instance, the embedded interrogative pronoun in (8) is in Spec, C<sub>t</sub>P, which allows the subject *Danaón* ‘Danaos’ to raise to the main clause and be assigned accusative case.

(8) Ἄkousen Danaón pot’ en Árgei | [ hoíon Danaòs  
 hear:AOR.3s Danaos:ACC.SG once in Argos:DAT.SG which:ACC.SG Danaos:NOM.SG  
 heûren tessarákonta kai oktò parthénoisi prîn méson âmar  
 find:AOR.3s 40 and 8 girl:DAT.SG before middle:ACC.SG day:ACC.SG  
 heleîn | ōkútatōn gámon ]  
 take:INF.AOR quickest:ACC.SG wedding:ACC.SG  
 “He heard how Danaos long ago in Argos found for his forty-eight daughters, before midday came, the quickest wedding (lit. which quickest wedding Danaos once found).”  
 (P. 9.112–114)

By contrast, in (9), a genitive \**hērōos theoû* ‘the hero-god’ (matching the coreferent *Hērakléos*) would be ungrammatical.

- (9) Oukéti próso | abátān hála kíonōn<sub>i</sub> hupèr  
 not.anymore further trackless:ACC.SG salt:ACC.SG pillar:GEN.PL over  
 Hērakléos perân eumarés, | [ hērōs theòs  
 Herakles:GEN.SG cross:INF.PST easy:NOM.SG hero:NOM.SG god:NOM.SG  
 hās<sub>i</sub> éthēke nautiliās eskhátās. ]  
 REL:ACC.PL set.up:AOR.3s navigation:GEN.SG farthest:ACC.SG  
 “It is not easy to cross the trackless sea beyond the pillars of Herakles, which the hero-god set up as the famous witnesses of the limit of navigation.” (N. 3.20–23)

This is because it would imply a movement of the raised nominal through Spec, C<sub>1</sub>P, which is already occupied by the RP. Crucially, the homonymy of the interrogative pronoun *hoion* in (8) with a RP makes it clear that the reason for this difference is syntactic in nature.

This line of explanation is also true for other types of extraction, where the extracted DP is not assigned a case within the matrix clause. Again, this is allowed with complement clauses and embedded interrogatives, but not with RCs.<sup>5</sup> The examples adduced in the literature (e.g. Probert 2015: 217) imply topicalized phrases pertaining to the matrix clause and not specifically to the RC. In (10), for instance, the dative DP *amphotéroisi* ‘(with) both of them’ appears to be the object of the verb *enkúrsēi* ‘he gains’ in the RC and to have been extracted to the leftmost topic position.

- (10) Tò dè patheîn eû prôton aéthlōn; eû d’  
 ART:NOM.SG CONN undergo:INF.AOR well first:NOM.SG prize:GEN.PL well CONN  
 akoúein deutérā moîr’; amphotéroisi d’ anér<sub>i</sub> |  
 hear:INF.PST second:NOM.SG lot:NOM.SG both:DAT.PL CONN man:NOM.SG  
 [ hōs<sub>i</sub> àn enkúrsēi kai héléi ], stéphanon  
 REL:NOM.SG IRR gain:SBJV.PRS.3s and take:SBJV.PRS.3s crown:ACC.SG  
 húsiston dédektai<sub>i</sub>,  
 highest:ACC.SG get:PRS.3s  
 “Success is the best prize; good reputation is the second lot; with both of them, a man who gains and takes them gets the highest crown.” (P.1.99–100)

However, *amphotéroisi* is best construed as the left-detached topic of the whole sentence, on a par with *tò patheîn eû* ‘success’ and *eû akoúein* ‘good reputation’ in the same line, and syntactically as an comitative-instrumental dative<sup>6</sup> rather than the object of *enkúrsēi* (note that the coordinated

<sup>5</sup> Cross-linguistically, RCs are not always islands for extraction (Christensen & Nyvad 2014; Sichel 2018).

<sup>6</sup> The bare dative case is often used with instrumental or comitative force (Hummel 1993: 129–130 for Pindar; Luraghi 2003b: 68–72 for AG in general).

verb *hélēi* ‘he takes’ within the RC would take an accusative object).<sup>7</sup> It is thus probably not an instance of PRP: even in Pindar, extraction in general and raising to object in particular are not attested with RCs.

How come, then, that some RCs can have material in front of the RP? An easy way around this syntactic difficulty would be to assume a projection above the C<sub>h</sub>P to accommodate topic phrases, a solution readily accepted by Cinque (2020: 58–64) for Latin and Georgian. Still, a major issue would remain because not all elements in front of a PRP are topical. While some of them are clearly topic phrases, as *hērōs theós* ‘the hero-god’ in (9) above, others are clearly focal, as *Gígantas* ‘the Giants’ in (11).

- (11) En t<sub>i</sub>n<sub>i</sub> k’ ethéloi [ Gígantas h<sub>o</sub>s<sub>i</sub> edámasas ],  
 in you:DAT.SG IRR want:OPT.3s giant:ACC.PL REL:NOM.SG subdue:AOR.2s  
 eutukh<sup>h</sup>ōs | naíein.  
 gladly inhabit:INF.PST  
 “Under your protection, you who subdued the Giants, would he gladly live.”  
 (N. 7.90–91)

Of course, one could posit two projections above Spec, C<sub>h</sub>P, one for topic phrases and one for focus phrases; but then a mechanism should be devised to prevent overgeneration, because nothing would stop both topic and focus from appearing at the same time, while, as we will see in section 5, the data show that there cannot be more than one constituent in front of a PRP. Moreover, the impossibility of extraction and raising to object with RCs would remain unexplained.

A further complication arises anyway, since other instances of PRPs involve an element of unclear informational status, which is certainly neither topic nor focus, like the finite verb form *télesen* in (12).

- (12) h<sub>o</sub>s pákhei mákei te pentēkóntoron naún,  
 REL:NOM.SG thickness:DAT.SG length:DAT.SG and fifty-oar:ACC.SG ship:ACC.SG  
 krátei, | [ télesen h<sub>an</sub>i plāgai sidárou ].  
 surpass:IMP.3s achieve:AOR.3p REL:ACC.SG blow:NOM.PL iron:GEN.SG  
 “[a dragon] which in thickness and length surpassed a fifty-oar ship, that the blows of a hammer built.” (P. 4.245–246)

In any case, the element in front of the PRP is a topic in only 17 instances (38.64%) and a focus in 14 instances (31.82%), which leaves the other 13 instances (29.55%) unaccounted for. Consequently, we must rule out the idea that RCs with PRPs involve topicalization or focalization and stick to the syntactic analysis of the CP left periphery presented by Faure (2021b).

<sup>7</sup> Definite referential null-objects are pervasive in AG, especially when their referent is highly topical, and even with coordinated verbs taking different cases (Luraghi 2003a). In (10), both conditions are met.



Before we turn to the analysis of PRPs in Pindar, note that they are more broadly a feature of lyric and dramatic poetry, across dialects.<sup>8</sup> Although this peculiarity has been sometimes noted (Monteil 1963: 80; Ruijgh 1971: 984; West 1974: 112; Hajdú 1989: 155–156; Probert 2015: 130), it has never been explained. Two questions must then be addressed: First, which are the factors that license the postponement of the RP? Second, why is there variability between IRPs and PRPs?

### 3 Overview of the data

To answer those questions, all 370 RCs in the surviving texts by Pindar were collected and tagged for various traits.<sup>9</sup>

#### 3.1 Relative pronouns in Pindar

Pindar, like Homer and Ionian prose writers, used two competing SIMPLE RPs (des Places 1947: 37–38; Monteil 1963: 23–73; Probert 2015: 120–124). The first one was the specialized RP *hós* (from the Proto-Indo-European root *\*Hyó-*), while the second one was the demonstrative-anaphoric pronoun *ho* (from the Proto-Indo-European alternating root *\*só-/ \*tó-*), which later became the definite article of classical Greek (Manolessou & Horrocks 2007; Guardiano 2013). **Table 1** presents the distribution of the different forms for both paradigms and their position within the RC.

			<i>*só</i>	Initial	Post.	Total	<i>*Hyó-</i>	Initial	Post.	Total
Singular	Masculine	Nominative	<i>ho</i> <sup>10</sup>	6	1	7	<i>hós</i>	43	7	50
		Accusative	<i>tón</i>	32	1	33	<i>hón</i>	17	1	18
		Genitive	<i>toû</i>	2	0	2	<i>hoû</i>	1	0	1
		Dative	<i>tôi</i>	6	0	6	<i>hôi</i>	2	1	3

(Contd.)

<sup>8</sup> Sporadic attestations come from Alcaeus (7<sup>th</sup>–6<sup>th</sup> c. BCE, Aeolian, monodic lyric), Theognis (6<sup>th</sup> c. BCE, Ionian, elegy), Stesichorus (6<sup>th</sup> c. BCE, Dorian, choral lyric), Bacchylides (5<sup>th</sup> c. BCE, Dorian, choral lyric), Aeschylus, Sophocles, and Euripides (5<sup>th</sup> c. BCE, Attic, tragedy). PRPs are not attested in Homer (8<sup>th</sup> c. BCE, Ionian, epic poetry), nor, crucially, in prose.

<sup>9</sup> A handful of instances were discarded, because their position is ambiguous, due to the fragmentary nature of the passage: *hón* (fr. 52f.78), *hína* (fr. 52g(e).2), *hoîa* (fr. 52s.8), *hoús* (fr. 169a.51).

<sup>10</sup> The only instance of postponed *ho* (P. 1.74 = example (39) below) has a textual variant *hós* in two of the manuscripts, once as a correction. Since the following word is *sphin*, it is impossible to decide one way or the other, because *hó sphin* and *hós sphin* would not differ metrically. This instance is excluded from the statistics whenever the lexical difference between RPs is at stake.

			*só	Initial	Post.	Total	*Hyó-	Initial	Post.	Total
	Feminine	Nominative	<i>(hā)</i>				<i>há</i>	10	1	11
		Accusative	<i>tán</i>	15	2	17	<i>hán</i>	4	2	6
		Genitive	<i>tās</i>	6	0	6	<i>hās</i>	1	0	1
		Dative	<i>tāi</i>	1	0	1	<i>hāi</i>	4	2	6
	Neuter	Nominative	<i>tó</i>	0	0	0	<i>hó</i>	0	0	0
		Accusative	<i>tó</i>	3	1	4	<i>hó</i>	0	0	0
		Genitive	<i>toû</i>	1	0	1	<i>hoû</i>	2	0	2
		Dative	<i>tôî</i>	1	0	1	<i>hôi</i>	1	0	1
		Locative	<i>tóthi</i>	5	1	7	<i>hóthi</i>	1	1	2
		Ablative					<i>hóthen</i>	6	0	6
	Plural	Masculine	Nominative	<i>(hoi)</i>				<i>hoí</i>	8	1
Nominative			<i>toí</i>	4	1	5				
Accusative			<i>toús</i>	5	0	5	<i>hoús</i>	1	0	1
Genitive			<i>tôn</i>	1	0	1	<i>hôn</i>	7	0	7
Dative			<i>toîs</i>	3	0	3	<i>hoîs</i>	5	4	9
Feminine		Nominative	<i>(hai)</i>				<i>haí</i>	0	1	1
		Nominative	<i>taí</i>	1	0	1				
		Accusative	<i>tás</i>	0	0	0	<i>hás</i>	1	2	3
		Genitive	<i>tân</i>	1	0	1	<i>hân</i>	0	0	0
		Dative	<i>taîs</i>	2	0	2	<i>haîs</i>	2	0	2
Neuter		Nominative	<i>tá</i>	2	0	2	<i>há</i>	0	0	0
		Accusative	<i>tá</i>	2	0	2	<i>há</i>	0	0	0
		Genitive	<i>tôn</i>	6	1	7	<i>hôn</i>	2	0	2
		Dative	<i>toîs</i>	1	0	1	<i>hoîs</i>	1	0	1
<b>Total</b>				<b>106</b>	<b>8</b>	<b>114</b>		<b>119</b>	<b>23</b>	<b>142</b>

**Table 1:** Forms of both simple relative pronouns in Pindar.

Categorization of certain forms is complicated by instances of homonymy, which leads to ambiguity. First, because the difference in accentuation is really a matter of the editor's choice (Monteil 1963: 23; Probert 2015: 121–122), the forms *hoí/hoi* and *haí/hai* (respectively masculine and feminine nominative plural) are a priori ambiguous, accented forms belonging to the *hós*-paradigm, unaccented forms to the *ho*-paradigm.<sup>11</sup> But since Pindar also uses the unambiguous nominative plural forms *toí* and *taí* from the *ho*-paradigm, the forms *hoí* and *haí* are likelier to derive from the root *\*Hyó-* instead (Monteil 1963: 74), and were categorized as such in the data.<sup>12</sup> Second, the feminine singular *há* (< *\*Hyéh<sub>2</sub>*) is homonymous with *hā* (< *\*seh<sub>2</sub>*), but disambiguation is impossible in that case. All occurrences of relative *há* are presented in **Table 1** as reflexes of *\*Hyéh<sub>2</sub>*, but I will discard them from the statistics whenever it is relevant.

Besides simple *hós* and *ho*, AG had a wealth of specialized RPs that added some semantic nuance to the RC. Pindar is no exception, since his poetry displays three COMPLEX RPs (the fusion of *hós* and some clitic) and two DERIVED RPs, all based on the root *\*Hyó-* (**Table 2**), as well as several adverbial RPs deriving from other roots (**Table 3**).

Pronoun	Semantics	Initial	Postponed	Total
<i>hóstis</i>	indefinite RP <sup>13</sup>	18	0	18
<i>hóspēr</i>	specific RP	7	0	7
<i>hóste</i>	generalizing RP	25	5	30
<i>hoíos/hopoíos</i>	RP of quality	15	4	19
<i>hós(s)os/hopós(s)os</i>	RP of quantity	21	1	22
<b>Total</b>		<b>86</b>	<b>10</b>	<b>96</b>

**Table 2:** Complex and derived RPs in Pindar.

<sup>11</sup> Following Probert (2015: 122, fn. 11), all instances of masculine *ho* in my corpus were counted as reflexes of *\*so-*, considering that there is no endingless nominative masculine singular *\*\*hó* (< *\*Hyó-*) (contra Monteil 1963: 74–75).

<sup>12</sup> As pointed out by an anonymous reviewer, the dialectal mixture of Pindar's language does not entirely rule out the forms *hoi* and *hai* (< *\*só-*) (see also Probert 2015: 121 fn. 9). However, one could argue that the retention of the older unambiguous forms *toí* and *taí*, which were later replaced by *hoí* and *haí* by analogy with the singular nominative forms, originated in the desire to keep the paradigms distinct.

<sup>13</sup> On the difference between *hós* and *hóstis* in terms of identifiability of their referent, see Faure (2015).

Pronoun	Semantics	Initial	Postponed	Total
<i>hína</i>	‘where’	15	3	18
<i>hopâi</i>	‘to the point where’	1	0	1
<i>éntha/énthen</i> <sup>14</sup>	‘where, whither’	11	1	12
<b>Total</b>		<b>27</b>	<b>4</b>	<b>31</b>

**Table 3:** Adverbial RPs in Pindar.

Two further difficulties in classification arise. First, in Pindar *ho* can be used as a demonstrative-anaphoric pronoun as well.<sup>15</sup> Consequently, many RCs could be construed as paratactic clauses with an anaphoric pronoun. I considered that the absence of coordination (asyndeton) secured a relative reading of the pronoun, while the presence of coordination guaranteed a demonstrative reading.

Second, RPs can also be used to introduce embedded interrogative (22 ×: see ex. (8) above), exclamative (13 ×), or comparative clauses (3 ×). Since their syntax is different from that of RCs (Faure 2010), all those instances were excluded from the corpus.

### 3.2 The lexical distribution of relative postponement

The most obvious observation that one can make is that the postponement of RPs is in part lexically driven, as can be seen on **Figure 1**.<sup>16</sup> Overall, *hós*-RPs are more prone to postponement than *ho*.<sup>17</sup>

This difference is significant if we compare only simple *hós* and *ho*.<sup>18</sup> This runs against expectations, however: since *ho* is more likely than *hós* to be an anaphoric pronoun rather than a true RP, we expect it to be more easily postponed.

<sup>14</sup> Although Slater (1969: 177) only glosses the word as “from there,” relative uses of *énthen* are attested in AG, so they cannot be excluded a priori.

<sup>15</sup> In theory, *hós* too could have anaphoric uses, similar to those attested in Homer as well as in Ionian and Attic prose, but Probert (2015: 393–398) makes a good case for attributing those to a form \**só-s*, cognate with Sanskrit *sáḥ*. In Pindar, there is no instance of *hós* in an unambiguously anaphoric use (pace des Places 1947: 36–37, who incorrectly cites I. 2.11 and fr. 94b.58, both without coordination).

<sup>16</sup> Non-relative complementizers have an even higher rate of postponement in Pindar (50 out of 262 tokens, 19.08%), which is not particularly surprising, because they are located in the lower position, which allows topicalization, even in prose (Faure 2021a).

<sup>17</sup>  $p = .051$  (Fisher’s exact test, ambiguous examples excluded).

<sup>18</sup>  $\chi^2(1) = 6.62, p = 0.010$  (ambiguous forms were excluded).

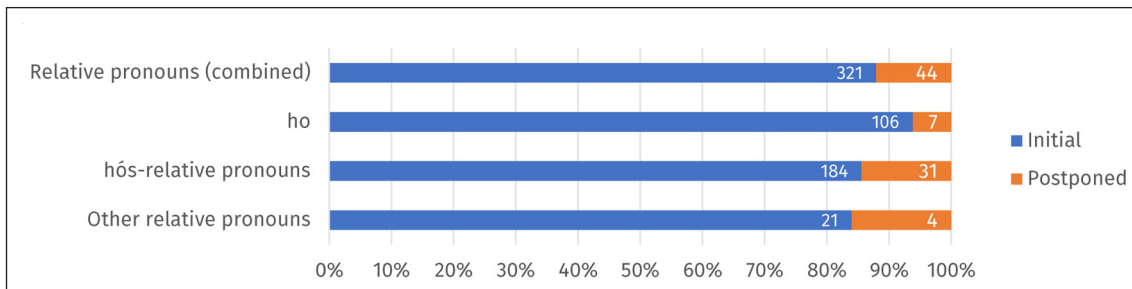

**Figure 1:** Position of relative pronouns by lexical type.

## 4 Identity between clauses with initial and postponed RPs

As we have seen, PRPs occur in only a small subgroup of RCs. This section is devoted to the exploration of the factors that make those RCs special, in order to identify what triggers the postponement of a RP: section 4.1 investigates the semantic differences between RCs with or without postponement, while section 4.2 addresses their syntax.

### 4.1 Indifference to semantic factors

In many languages, semantic factors affect the layout of RCs, most importantly the definiteness of the referent and the semantic nature of the RC itself. Both will be tackled in what follows.

#### 4.1.1 Definiteness of the head

The definiteness of the RC’s head has been claimed to be the key in the optional postponement of the RP in Hittite.<sup>19</sup> Whatever the exact situation in that language, it gives us an indication that the use of PRPs might be linked to such a semantic trait.

In Pindar, two factors make it difficult to ascertain the definiteness of the head. First, there is no systematic use of the definite article in his dialect.<sup>20</sup> Second, the rhetorical stance of the poet leads to ambiguity in this regard: in a mythological allusion, is the referent of the DP supposed to be identifiable by the audience? Take example (13): if we assume the referent of *karteròn* [...] *lítthon* ‘the/a mighty stone’ is identifiable by the audience, then the DP is definite; on the other hand, if the audience is not supposed to identify the stone, the DP is indefinite.

<sup>19</sup> According to Held (1957), PRPs only appear in RCs with identifiable heads, among which he further distinguishes “determinate” correlative and “indefinite” postnominal restrictive RCs; in all other RCs, the RP must be initial in the clause (preceded only by connective adverbs). This position has become the standard view (Garrett 1994; Hoffner & Melchert 2008: 423–426). The syntax of RPs in Hittite, however, is certainly more complex than this account (Lühr 2001; Becker 2014; Sideltsev 2015).

<sup>20</sup> See Slater (1969: 368) for possible instances of the definite article; note, however, that the distinction between definite article and demonstrative adjective is not clear-cut in Pindar.

- (13) Patèr húper | krémāse karteròn<sub>i</sub> autôî líthon<sub>p</sub> |  
 father:NOM.SG above suspend:AOR.3p mighty:ACC.SG him:DAT.SG stone:ACC.SG  
 [ tòn<sub>i</sub> aieî menoinôn kephalâs baleîn  
 REL:ACC.SG always long:PTCP.PRS.NOM.SG head:GEN.SG throw:AOR.INF  
 euphrosúnās alâtai ].  
 joy:GEN.SG wander:PRS.3s  
 “The Father suspended above him a/the massive rock, which/that he is always longing  
 to cast away from his head, while wandering far from joy.” (O. 1.57–58)

Classification may still be achieved through a careful case-by-case analysis. As can be seen in **Figure 2**, there is no statistically significant difference between IRPs and PRPs in this regard,<sup>21</sup> which means that, contrary to what is claimed for Hittite, the definiteness of the head nominal is not a triggering factor for postponing the RP in Pindar.

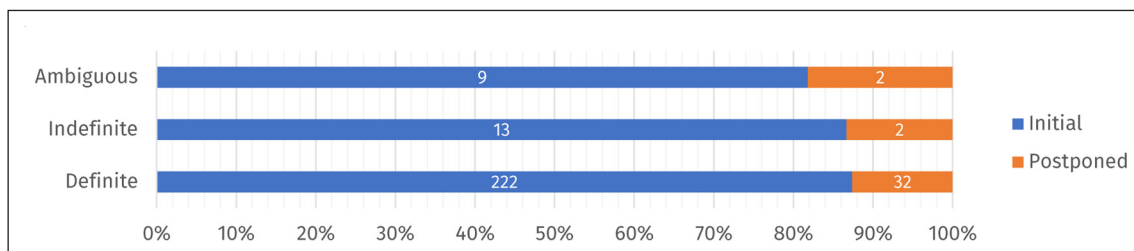

**Figure 2:** Position of the RP according to the definiteness of the nominal head.

#### 4.1.2 Semantic typology of relative clauses

A second way to apprehend RCs semantically is restrictiveness. Following the standard classification of RCs as established by Lehmann (1984; 1986) and completed by Grosu & Landman (1998), RCs in AG can be restrictive, non-restrictive or maximalizing.

A RESTRICTIVE RC further limits the reference of an NP. In (14), the people referred to by the NP *andròs oúte gunaikós* ‘the man and the woman’ can only be identified with the restriction of the RC.

- (14) andròs d’ oúte gunaikós, [ hōn thálessin énkeimai ].  
 man:GEN.SG CONN nor woman:GEN.SG REL:GEN.PL scion:DAT.PL be.at:PRS.1s  
 “to the man and the woman at whose scions’ house I find myself.” (fr. 94b.36)

On the other hand, the description added by a NON-RESTRICTIVE RC does not narrow the extension of the referent. In (15), the land in question is already identifiable by virtue of the

<sup>21</sup>  $p = .792$  (Fisher’s exact test).

possessive adjective *sphetéran*, and the following RC is new information that does not restrict the reference any further.

- (15) gaían anà sphetéran, [ tân dè kaléoisin Olumpíou  
 earth:ACC.SG in their:ACC.SG REL:ACC.SG PTC call:PRS.3p Olympian:GEN.SG  
 Díos | álsos ]  
 Zeus:GEN.SG sacred.grove:ACC.SG  
 “in their land, which is called the Sacred Grove of Olympian Zeus.” (I. 2.27–28)

MAXIMALIZING RCs (Grosu & Landman 1998) exhaust all the possible referents of the head, as in (16). Note that, in AG, maximalizing RCs are optionally marked by the specialized RP *hósoi*.

- (16) paídessin Hellánōn [ hósoi Troíand’ éban ]  
 child:DAT.PL Greek:GEN.PL REL:NOM.PL Troy:ALL.SG go:AOR.3p  
 “to all the sons of the Greeks who went to Troy” (I. 4.54b)

We may now examine the interplay between the semantics of the RC and the position of the pronoun: if the semantic nature of the RC is a factor in the postponement of the RP, then PRPs should be restricted to certain types of RCs. **Figure 3** shows that this is not the case.<sup>22</sup>

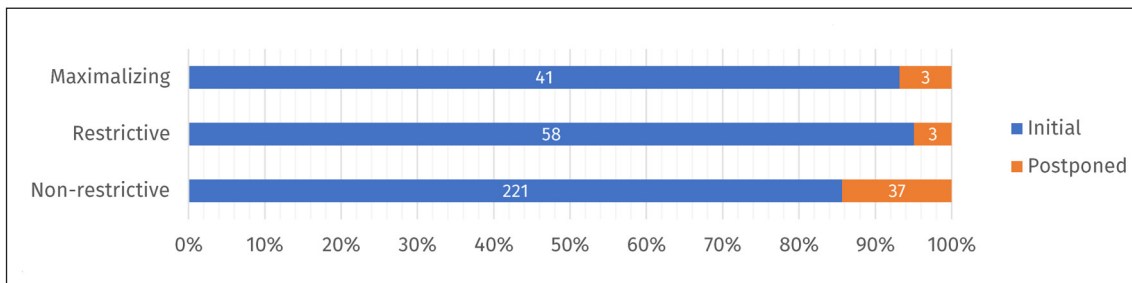

**Figure 3:** Position of the RP according to the semantic nature of the RC.

Although PRPs seem to have a greater affinity with non-restrictive RCs, this trend is not statistically significant. We must then conclude that the postponement of the RP is not correlated with the semantic nature of the RC.

#### 4.1.3 Interim summary

Contrary to what happens in other languages, the semantics of the RC does not seem to play any major role in the appearance of PRPs in Pindar:<sup>23</sup> Neither the definiteness of the head nor the

<sup>22</sup>  $\chi^2(2) = 5.41, p = .067$ .

<sup>23</sup> The animacy of the referent, suggested to me as a potential licensing factor by Marie-Albane Watine (p. c.), has no influence either:  $\chi^2(1) = .0218, p = .883$  (ambiguous cases excluded).

semantic type of the RC are correlated with the position of the RP. PRPs are just like IRPs as far as semantics is concerned.

## 4.2 Identical syntax of initial and postponed relative pronouns

If PRPs are not used by Pindar to mark any semantic feature of the head or the RC, they do not show any syntactic difference with IRPs either. Three arguments will be adduced: first, PRPs are indifferent to case (section 4.2.1); second, clauses with PRPs do not differ in headedness (section 4.2.2); third, PRPs do move syntactically to Spec, C<sub>1</sub>P, contrary to what the linear order may indicate (section 4.2.3).

### 4.2.1 Case accessibility hierarchy

Languages vary in terms of their ability to relativize heads with different syntactic functions. Keenan & Comrie (1977) showed that this variation is not random, but follows an ACCESSIBILITY HIERARCHY, presented in (17), going from the most accessible to the least accessible (for an updated version, see also Maxwell 1979; Lehmann 1986: 667–668; Lau & Tanaka 2021).

- (17) Subject > Direct Object > Indirect Object > Oblique > Possessor > Object of Comparison  
(after Keenan & Comrie 1977: 67)

Many languages only relativize NPs on the left of this hierarchy, or, if they do relativize positions after a certain point on the hierarchy, they use a different relativization strategy. With that in mind, if PRPs are in a different syntactic position than IRPs, we may hypothesize that those positions are not equally accessible for every case. In other words, we would expect a different distribution of cases for PRPs and IRPs. That is not what happens, as evidenced by **Figure 4**, in which the association between the position of the RP and the RP case is far from significant.<sup>24</sup>

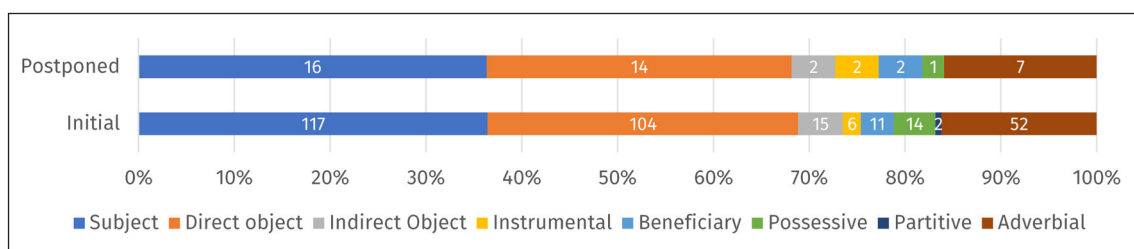

**Figure 4:** Position of the RP according to the case.

<sup>24</sup>  $p = .907$  (Fisher's exact test).



At least with regard to case accessibility, then, there is no detectable difference between PRPs and IRPs in Pindar.

#### 4.2.2 Headedness of the RC

As we saw in section 2.2, AG allows for postposed and preposed externally headed, internally headed, and null-head RCs. All types occur with PRPs as well in verse, as shown by examples (18)–(20).

(18) Postposed externally headed:

Kádmōio kóurais<sub>i</sub>, [ épathon **hai**<sub>i</sub> megála ]  
 Cadmos:GEN.SG daughter:DAT.PL suffer:AOR.3p REL:NOM.PL big:N.ACC.PL  
 “to the daughters of Cadmos, who suffered a lot” (O. 2.23)

(19) Preposed externally headed<sup>25</sup>

[ Tàs dè daimónōn túkhās | **hóstis**<sub>i</sub> phérei  
 ART:ACC.PL CONN divinity:GEN.PL fortune:ACC.PL REL:NOM.SG bear:PRS.3s  
 kállist’ ] anèr<sub>i</sub> hoûtos sophós  
 good:NT.ACC.PL man:NOM.SG DEM:NOM.SG wise:NOM.SG  
 “Any man who bears with utter nobility the fortunes sent by the gods, this man is wise.” (Euripides fr. 37)

(20) Null-head:<sup>26</sup>

[ Thaneîn d’ **hoîsin** anánkā ], tá ké tis  
 die:INF.AOR CONN REL:DAT.PL necessity:NOM.SG why MOD INDF:NOM.SG  
 anónumon | gêras en skótōi kathêmenos  
 anonymous:ACC.SG old.age:ACC.SG in obscurity:DAT.SG seated:NOM.SG  
 hépsoi mátān?  
 follow:OPT.AOR.3s in.vain  
 “For those who must die, why would anyone follow in vain an anonymous old age, sitting in obscurity?” (O. 1.82–83)

There is only one potential candidate for a head-internal RC with PRP in Pindar (21).

(21) [ Emoî d’ **hopoían**<sub>i</sub> aretān<sub>i</sub> | édōke Pótmos  
 me:DAT.SG CONN REL/Q:ACC.SG virtue:ACC.SG give:AOR.3s Potmos:NOM.SG  
 ánaks ] | eû oíd’ hótī khrónos hérpōn  
 lord:NOM.SG well know:PRS.1s COMP time:NOM.SG pass:PTCP.PRS.NOM.SG

<sup>25</sup> Because the scarcity of preposed RCs in Pindar (only 3 examples, including one that is debatable) made it difficult to find an example of PRP in this configuration, I provide this example from Euripides (Kannicht 2004: 1.172).

<sup>26</sup> PRPs are typologically rare, but attested in null-head RCs (Demirok 2017; Cinque 2020: 114 fn. 161).

peprōménān telései  
 fated:ACC.SG achieve:FUT.3s  
 “whatever kind of virtue lord Potmos gave me, I know well that time passing will  
 achieve it as fated” (N. 4.41–43)

However, this could be an instance of an embedded question, with a contamination of two constructions, where *eû oîd(a)* ‘I know well’ serves as a pivot; more likely, it is a free-choice relative with a concessive meaning (Faure 2010: 385–387).

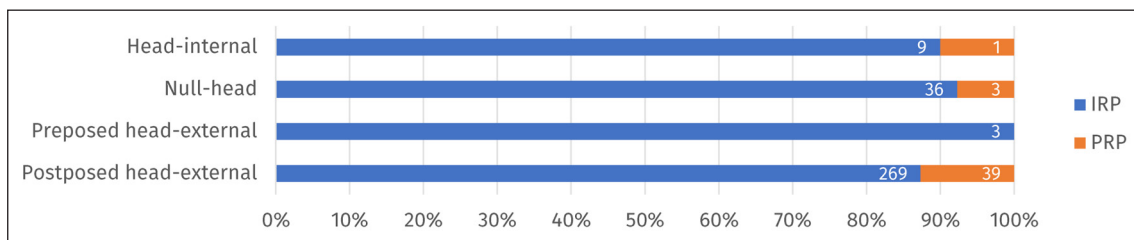

**Figure 5:** Position of the RP according to the syntactic type of the RC.

Again, as shown in **Figure 5**, there is no perceptible difference between IRPs and PRPs in the distribution of syntactic types.<sup>27</sup> Now, in every proposed syntactic theory for relativization, the derivation of each configuration is different, either with different movements (de Vries 2006), or different rules for spelling out copies of the RC’s head (Cinque 2020). This means that the syntax of RCs does not demonstrably differ whether it is headed by a PRP or an IRP.<sup>28</sup>

#### 4.2.3 Postponed relative pronouns are not in situ

We come now to a more structural argument. In some languages, it has been claimed that the RP is not always subject to *wh*-movement and can remain in situ.<sup>29</sup> In Punjabi (Indo-Aryan), for instance, RPs may either raise to the Spec, CP of the RC (22a), or remain in situ (22b) (Yang 2006).<sup>30</sup>

- (22) a. o kuRii<sub>i</sub> [ jeenu<sub>i</sub> rohit jeenu<sub>i</sub> pasand karda hai ] hoshiyaar hegi  
 b. o kuRii<sub>i</sub> [ rohit jeenu<sub>i</sub> pasand karda hai ] hoshiyaar hegi

<sup>27</sup>  $p = .897$  (Fisher’s exact test).

<sup>28</sup> Fauconnier (2014) shows that head-internal and head-external RCs are indeed different in AG, but she makes no mention of PRPs.

<sup>29</sup> It is generally admitted that only languages having a *wh*-in-situ strategy for interrogatives can have in situ RPs as well (de Vries 2005: 22). AG is such a language, albeit marginally (Bertrand & Faure 2022).

<sup>30</sup> Vedic Sanskrit is another case in point, with an optional preverbal position for the RP, exclusively in verse (Hock 1992a).

DEM girl REL:ACC Rohit REL:ACC like do is smart is  
 “The girl who Rohit likes is smart.” (after Yang 2006: 138–139 (9))

In more complex sentences, the RP can remain in situ (23a), or move to the intermediate clause CP (23b), or to the highest clause CP (23c); two copies can also be pronounced, namely the highest one and either of the lower ones (23d–e).

- (23) a. o kuRii<sub>i</sub> [ mona sochdi hagi [ rani jeenu<sub>i</sub>  
 b. o kuRii<sub>i</sub> [ mona sochdi hagi [ jeenu<sub>i</sub> rani jeenu<sub>i</sub>  
 c. o kuRii<sub>i</sub> [ jeenu<sub>i</sub> mona sochdi hagi [ jeenu<sub>i</sub> rani jeenu<sub>i</sub>  
 d. o kuRii<sub>i</sub> [ jeenu<sub>i</sub> mona sochdi hagi [ jeenu<sub>i</sub> rani jeenu<sub>i</sub>  
 e. o kuRii<sub>i</sub> [ jeenu<sub>i</sub> mona sochdi hagi [ jeenu<sub>i</sub> rani jeenu<sub>i</sub>  
 f. \*o kuRii<sub>i</sub> [ mona jeenu<sub>i</sub> sochdi hagi [ jeenu<sub>i</sub> rani jeenu<sub>i</sub>  
 DEM girl REL:ACC Mona REL:ACC think is REL:ACC Rani REL:ACC  
 pasand kardi hai ] ]  
 pasand kardi hai ] ]  
 pasand kardi hai ] ]  
 pasand kardi hai ] ]  
 pasand kardi hai ] ]  
 pasand kardi hai ] ]  
 like do is  
 “the girl who Mona thinks Rani likes” (after Yang 2006: 150 (32))

Crucially, however, an internal position within the highest clause is impossible (23f). The reason is that the RP movement from the base position into the RC has first to go through the specifier position in the lower clause, and from there it must raise directly to the specifier position of the RC. This prevention is predicted by the theory of “improper movement” (Chomsky 1973): For such a configuration to arise, the RP would have to leave an A’ position (the embedded Spec, CP) and move to an A position within the matrix VP, yielding a non-uniform (A–A’–A) chain.

In Pindar, on the other hand, the RP can also be postponed within the higher clause.<sup>31</sup> In (24), the RP *hín(a)* is generated within the infinitive clause and raises not to the specifier of the embedding clause, but to a lower position within it, i.e. exactly the same structure as the ungrammatical (23f).

- (24) Éntha peíran ékhontes oíkade<sub>i</sub> klutokárpōn | ou  
 there experience:ACC.SG having:NOM.PL home glory-bearing:GEN.PL NEG

<sup>31</sup> Of course, the same situation also generates IRPs, as in (13) above.

néont’ áneu stephánōn, [ pátrān hín’<sub>i</sub> akoúomen |  
 return:PRS.3p without crown:GEN.PL family:ACC.SG REL:LOC hear:PRS.1p  
 Timásarkhe, [hína<sub>i</sub> teàn epinikíoisin aoidaís |  
 Timasarkhos:VOC.SG REL:LOC your:ACC.SG victorious:DAT.PL ode:DAT.SG  
 própolon émmenai hína<sub>i</sub>] ]  
 devoted:ACC.SG be:INF.PST REL:LOC

“With the experience they gained there, they did not go back home without glory-bearing crowns, where we hear that your family, Timasarkhos, was devoted to the victory odes.” (N. 4.76–79)

Admittedly, this last example is quite complex, as it also involves the raising of *pátrān* out of the infinitive clause to the beginning of the relative clause. In addition, infinitive clauses in AG have a tendency to fuse with their matrix, which can generate intricate word orders (Bertrand 2010: 332–333). Nevertheless, it shows clearly enough that the PRP is not in a clause-internal position but at the edge of the embedding clause.

Another factor makes it extremely difficult to prove that the position of the PRP is in situ, namely the principles of word order in AG. Across dialects, genres and periods, the linear order of constituents expresses the information structure of the clause, not syntactic relations (Dik 1995; Matić 2003a; Dik 2007; Bertrand 2009; 2010). A NON-RATIFIED TOPIC (NRTop)<sup>32</sup> moves to the initial position in the sentence (which can harbor more than one topic phrase). If only one non-verbal element is in the focus, it moves to the immediately preverbal NARROW FOCUS (NFoc) position (25a). If the verb and optionally other elements are in the focus, they build up a FOCUS DOMAIN with the verb at its left boundary (25b). In both constructions, a RATIFIED TOPIC (RTop) can appear, usually immediately after the verb; however, it is phonologically demoted and exhibits a postpositive behavior (see section 5.1 for more on postpositives in AG).

- (25) a. NRTop(s) **NFoc** Verb RTop Presupposed elements  
 b. NRTop(s) [ **Verb** RTop **Focal elements** ]<sub>Focus Domain</sub>

Now, the informational role of a RP within its RC is always topic (Kuno 1976; Bresnan & Mchombo 1987: 757; Haberland & van den Auwera 1990; Lambrecht 1994: 129–130):<sup>33</sup> the RC is construed as being *about* the referent of the RP. If RPs are NRTops, this would conspire with *wh*-movement

<sup>32</sup> This terminology was first established by Lambrecht & Michaelis (1998). A non-ratified topic is established at the moment of utterance as the topic of the following clause, whereas a ratified topic is already considered a topic at the moment of utterance. The distinction is equivalent to the one between “frame-setting topics” and “continuous topics” drawn initially by Matić (2003a).

<sup>33</sup> This topic function fits well with their identificational nature, as proposed by Faure (2021b: 215).

to make it initial in its clause; if, on the other hand, they are RTops, the post-verbal position would be preferred.<sup>34</sup> Crucially, however, there is no in situ position for the RP in this approach.

Syntactically, on the other hand, Faure (2021a: 31–33) recently argued that AG is underlyingly SVO. If the RP remained in situ, one would expect subject PRPs to be preverbal and object PRPs to be postverbal. However, the data does not confirm this prediction: subject PRPs are only rarely immediately preverbal and may even appear postverbally, while object PRPs hardly occur after the verb (Table 4).

Syntactic role of the RP	XP RP V	XP RP... V	V RP	Total
Subject	4	9	3	16
Direct Object	3	8	2	13
Total	7	17	5	29

**Table 4:** Position of the PRP in the linear order of the RC.

It is thus impossible to claim that in all those cases the PRP remains in situ. The same reasoning would apply if AG was VSO, of course: the postverbal position for either subject PRPs or object PRPs is the rarest, which implies that the PRP does move and cannot be in situ.<sup>35</sup>

#### 4.2.4 Interim summary

Up to this point, we have concluded that there is no semantic difference between RCs correlated to the position of their RP. On the syntactic level, three observations make it difficult to derive PRPs:

1. There is no topic or focus projections above the RP to allow raising of the phrase preceding the PRP.
2. Syntactic tests do not support a different derivation for IRPs and PRPs, which means that they must move to the same position.
3. The position of the PRP is not demonstrably in situ, which means, again, that it is subject to *wh*-movement.

---

<sup>34</sup> I will argue in section 5.4 that RP are indeed RTops.

<sup>35</sup> The position of PRPs cannot be explained either by a short movement to the left edge of the *vP*, or in a lower topic position of *vP*, as was the case with the RP *sǎo* in Archaic Chinese (Aldridge 2010: 28–30; Zhao & Zhang 2022). The mere existence of postverbal PRPs is enough evidence to rule out such a movement.

We are left with a minority of RCs with the same semantics and the same syntax as regular ones, differing only in linear order. The last resort hypothesis would then be a post-syntactic phonological rule; the rest of this paper is devoted to substantiating this idea.

## 5 Prosodic behavior of postponed relative pronouns

As far as the phonology of PRPs is concerned, the major consideration is that in all instances of postponement but one, the element of the RC preceding the PRP (henceforth “initial XP”) is located immediately to its left,<sup>36</sup> which means that the RC domain is continuous. The only apparent exception is example (10) above, but we have seen that it is not a valid instance of postponement. Once this example is discarded, then, there is no exception to the adjacency rule: even when the RP is postponed, the RC is always part of a single prosodic domain. Formally, this means that phonological and syntactic domains are always aligned, whether the RP is postponed or not.

Since the data failed to manifest any clear semantic or syntactic differences between PRP and IRP clauses, we may take advantage of this prosodic fact (the phonological unity of the RC with PRP) to put forward another explanation, namely that the RP may optionally be treated as a postpositive word. More precisely, I claim that all RPs move to the Spec, C<sub>h</sub>P position (recall the syntax of the CP left periphery as laid out in (7)), but they can be optionally treated as postpositive and, at the phonological level, end up in the second position in their clause. The rest of this section is devoted to fleshing out this hypothesis.

### 5.1 Postpositive words in Ancient Greek

In order to understand the behavior of PRPs, let us first have a look at postpositive words in AG in general. AG had a series of postpositive words, not all of them clitics per se, but all subject to the same rules in the linear order of the clause.<sup>37</sup> Because the lack of (graphic) accent is not sufficient to identify a word as postpositive in AG,<sup>38</sup> I will follow Goldstein (2015: 49–50) in conflating clitics and postpositives into the same category, based on their distributional properties, although I prefer the label “postpositive” to “clitic” (the latter might sound too narrow in a typological perspective). Postpositive words are defined by the following five criteria (26):

- (26) CRITERION 1. AVOIDANCE FOR FIRST POSITION:  
A postpositive word cannot be initial in its prosodic domain (Dover 1960: 12).

---

<sup>36</sup> Only twice a postpositive connective particle interrupts that contiguity (O. 1.82 and O. 13.107), but postpositives are invisible for word order calculation in AG (see further section 5.1).

<sup>37</sup> See Hajdú (1989: 1) for a complete inventory of postpositive words in Pindar.

<sup>38</sup> Ancient sources offer conflicting views on this classification (Devine & Stephens 1994: 354; Goldstein 2015: 50, fn. 1).

CRITERION 2. SENSITIVITY TO PROSODIC/SYNTACTIC DOMAIN:

A postpositive word selects a host at the left boundary of its prosodic/syntactic domain (Goldstein 2015).<sup>39</sup>

CRITERION 3. VARIABLE HOST SELECTION:

The host of the postpositive word can be a lexical word, a prosodic word, or a constituent, with interspeaker and even intraspeaker variation (Goldstein 2015: 82–84).

CRITERION 4. DOMAIN INTERRUPTION:

A postpositive word can interrupt a syntactic domain.

CRITERION 5. PHONOLOGICAL INCORPORATION WITH THE HOST:

A postpositive word is phonologically incorporated with its host (Goldstein 2015: 51–60)

CRITERION 1 is obviously the most problematic here, since PRPs are only a small subset of all RPs, which are usually initial in the RC. My claim, however, is that RPs are only optionally postpositive in AG verse (see section 5.4 for a tentative explanation). CRITERION 2 is trivially met, because the initial XP, by definition, is always at the left boundary of the RC. In order to demonstrate the postpositive behavior of PRPs, the remaining three criteria will be addressed in order.

## 5.2 Postponed relative pronoun as postpositives

### 5.2.1 Variable host selection (CRITERION 3)

According to CRITERION 3 in (26), the host of a postpositive must be the leftmost prosodic word, lexical word or constituent of a syntactic/prosodic domain. Typically, the host consists of only one lexical word (35×). Merely nine occurrences have more than one lexical word before the RP, as in (27).

- (27) Oud' Aídas            akinétān            ékhe            rhábdon<sub>i</sub> |            [ brótea  
 NEG Hades:NOM.SG unmoved:ACC.SG hold:3s.IMPF wand:ACC.SG mortal.ACC.PL  
 sómath'    hâ<sub>i</sub>            katágei            koílān            pros    águian |  
 body.ACC.PL REL:DAT.SG lead.down:PRS.3s hollow.ACC.SG towards city.ACC.SG  
 thnāiskóntōn. ]  
 dead:GEN.PL

“Nor did Hades keep his staff unmoved, with which he leads the mortal bodies down to the hollow city of the dead.” (O. 9.33–35)

Note however that *brótea sómat(a)* ‘mortal bodies’, while comprising two lexical words, makes up only one constituent. This is a general rule, as can be seen in **Table 5**.

---

<sup>39</sup> This is an up-to-date reformulation of the observation made by Wackernagel (1892), who noted that some words (connective adverbs or anaphoric pronouns) usually surface in the second position of a clause in several Indo-European languages.

Reference	Host	Syntax
O. 9.34 = (27) above	<i>brótea sómata</i> ‘mortal bodies’	[DP Adjective + Noun]
P. 2.5	<i>euármatos Hiérōn</i> ‘good-car Hieron’	
P. 5.78	<i>polúthuton éranon</i> ‘festival abundant in sacrifices’	
fr. 52d.36	<i>Krētôn maioménōn</i> ‘raging Cretans’	
N. 3.22 = (9) above	<i>hērōs theós</i> ‘god-hero’	[DP Noun + Noun] <sup>40</sup>
P. 1.74 = (39) below	<i>ōkupórōn apò nāōn</i> ‘from the swift-sailing ships’	[PP Adjective + Preposition + Noun]
fr. 146	<i>pûr pnéontos</i> ‘fire-breathing’	[VP Noun <sub>Direct Object</sub> + Verb] <sup>41</sup>
I. 2.9–11	<i>khrémata khrémat’ anér</i> ‘money, money is the man’	Reported speech

Table 5: Syntax of PRP hosts.

In only two instances, the host comprises three lexical words. In I. 2.9–11, the host is the whole quote *khrémata khrémat’ anér*, taken as an unbreakable constituent. Example (28) is more problematic, because the PRP is potentially preceded by more than one constituent, the subject infinitive phrase *essómenon proideîn* ‘to foresee the future’ and the predicative adjective *sungenès* ‘innate’.

- (28) Prássei gàr érgōi mèn sthénos, | boulaísi  
 make:PRS.3s CONN deed:DAT.SG CONN strength:NOM.SG counsel:DAT.PL  
 dè phrén, [ essómenon proideîn | sungenès  
 CONN mind:NOM.SG be:PTCP.FUT.ACC.SG foresee:INF.AOR native:ACC.SG  
 hoís, hépetai ].  
 REL:DAT.PL follow:PRS.3s  
 ‘‘for strength manifests itself through deeds, and mind through counsels, for those who have the natural ability to foresee what is to come (lit. for those whom foreseeing the future follows innately)’’ (N. 1.26–28)

<sup>40</sup> On this kind of classifying apposition, see Hackstein (2010: 11).

<sup>41</sup> *Pûr pnéō* ‘to breathe fire,’ which occurs 3× in Pindar, is an idiom (Ruijgh 1971: 986) functioning almost as a compound verb: the elements appear in fixed order and cannot be separated.



This example is admittedly quite contrived, but it is liable to a prosodic explanation. Note that, even if there are two constituents in front of the PRP here, *hoīs* is still second in its prosodic domain, i.e. the metrical line.

The metrical line is an idealized phonological domain in AG poetry: even if the position of word-ends within the line is regulated (the so-called *caesurae* are mandatory word-ends, whereas metrical bridges are avoided word-ends), the line is the domain where a number of sandhi phenomena apply: progressive and regressive resyllabification (Devine & Stephens 1994: 235–248), as well as elision, shortening of long final vowels or diphthongs, and floating segments for hiatus resolution (Devine & Stephens 1994: 253–271). Crucially, sandhi applies within the whole metrical line, even across clause and sentence boundaries. On the other end, no such effects can occur at a line-end, which licenses instead prepausal phenomena (hiatus and lengthening of light syllables). Thus, while the prosodic structure of the metrical line reflects the prosodic structure of spoken language, this equivalence is not one-to-one.<sup>42</sup>

Now, in example (28), it can be argued that the PRP selected its host not at the left boundary of its syntactical domain, but at the left boundary of its phonological domain as defined by the metrical line, giving precedence to prosody over syntax. As Goldstein (2014: 510–511) puts it, while explaining a similar instance of a second-position clitic surfacing later in the sentence in Sophocles, “the prosody of the metrical verse licenses additional positions for clitics that are not available in non-metrical environments.” Pindar provides a handful of examples of second-position clitics and postpositives which actual location is best explained along those lines.<sup>43</sup> In (29), the connective particle *gār* ‘because’ should select *én* ‘inside’ as its host, as it is the first lexical word of its syntactic domain.

- (29) all’ én | kékrup̄to    =gār skhoínōi  
 but inside hide:PERF.3s PTC bed.of.rushes:DAT.SG  
 “because he was hidden in a bed of rushes” (O. 6.53–54)

Even more radically, in (30) the clitic anaphoric pronoun *nin* ‘him’ is postponed after the adjective *Istrīān* ‘of the Danube’ across a stanza-break, instead of selecting as its host either *tót(e)* ‘then’ in the infinitive clause, or *thūmós* ‘heart’ in the matrix clause.

- (30) dé tót’ es gaīan            poreúen thūmòs hór̄mā | Istrīān  
 then to land:ACC.SG travel:INF heart urge:IMPF.3s of.the.Danube:acc.sg  
 =nin  
 him:ACC.SG  
 “Then his heart urged him to travel to the land of the Danube.” (O. 3.25–26)

<sup>42</sup> The metrical outfit of Pindaric verse will be discussed more at length in section 5.2.3 below.

<sup>43</sup> Hajdú (1989: 83, 111, 118, 123, 126, 135) attributes such cases in Pindar and his contemporary Bacchylides to the presence of a line-end. Similar mismatches between prosodic and syntactic domains for clitic position occur in Sanskrit as well (Hock 1992b; 2000).

Interestingly, among PRPs, the phenomenon remains limited to the isolated instance (28): there seems to be a marked preference for matching prosodic and syntactic domains.

### 5.2.2 Domain interruption (CRITERION 4)

A consequence of the phonological deficiency of postpositives is that they are invisible in the word order of the clause, which allows them to interrupt a syntactic domain. That is true of PRPs as well, as in (31), where the DP *pláksippon* [...] *Thébān* ‘horse-striking Theba’ is split by the RP *hā*.

- (31) Mātromātōr                      emā                      Stumphālís,  
 mother’s.mother:NOM.SG   my:NOM.SG   woman.of.Stymphalos:NOM.SG  
 euanthēs                      Metōpā, |                      [ [pláksippon<sub>j</sub>                      hā<sub>i</sub>  
 fair-flowered:NOM.SG   Metopa:NOM.SG   horse.striking:ACC.SG   REL:NOM.SG  
*Thébān*,]                      étikten ]  
 Theba:ACC.SG   bear:AOR.3s  
 “My mother’s mother the woman of Stymphalos, fair-flowered Metopa, who bore the rider Theba” (O. 6.84–85)

Such a situation obtains 13 times in my corpus. One could argue, however, that it’s a case of so-called hyperbaton, or discontinuous constituent, a common feature of AG, subject to very few restrictions in verse (Devine & Stephens 2000). Indeed, we find five occurrences where the DP is not only interrupted by the PRP, but by other material as well. For instance, in (32), the DP *themisteion* [...] *skâpton* ‘holy scepter’ is broken up not only by the RP *hós*, but also by the verb *amphépei* ‘holds’.

- (32) mákairan                      Hiérōnos<sub>i</sub>                      hestīān |                      [ *themisteion*<sub>j</sub>                      hōs<sub>i</sub>  
 blessed:ACC.SG   Hieron:GEN.SG   hearth:ACC.SG   holy:ACC.SG   REL:NOM.SG  
*amphépei*   *skâpton*<sub>j</sub>                      en   polymélōi |                      Sikelíai ]  
 hold:PRS.3s   scepter:ACC.SG   in   sheepful:DAT.SG   Sicily:DAT.SG  
 “the blessed hearth of Hieron, who holds the holy scepter in sheepful Sicily” (O. 1.11–13)

Still, cases like (32) with discontinuous constituents are almost three times less frequent than cases like (31), where the DP would be continuous save for the interrupting PRP. It seems safer to consider them as continuous constituents, with the harmless interruption of a postpositive word.

This ability to interrupt syntactic domains is due to a different approach to what counts as the first word of a phonological domain, which is targeted as the host of the postpositive. A postpositive will either select the first constituent, or the first lexical word of the constituent, even if it ends up within this constituent. In AG, it is very common for postpositive connectors and other discourse particles to exhibit both behaviors, even in texts by the same author.<sup>44</sup>

<sup>44</sup> Such variation was also noted for Hittite clitics (Huggard 2015: 121, fn. 5).

Anaphoric pronouns, either true clitics like *min* or accented postpositives like *autón*, are more prone to select a whole constituent as their host (33a), but are also able to interrupt it (33b).

- (33) a. meilikhóisi            lógois            **ααutoùs**            Iásōn  
 mellifluous:DAT.PL    speech:DAT:PL    them:ACC.PL    Jason:NOM.SG  
 dégmenos  
 receive:PTCP.PRF.NOM.SG  
 “once Jason had welcomed them with honey-sweet words” (P. 4.128)
- b. glukù<sub>i</sub>            =gàr            **ααutôi**            mélos<sub>i</sub>            opheílōn  
 sweet:ACC.SG    CONN    him:DAT.SG    song:ACC.SG    owing:NOM.SG  
 epilélāth(a)  
 forget:PRF.1s  
 “for I forgot the sweet song I owed him” (O. 10.3)

It is thus by no means surprising that PRPs surface within a constituent in almost a third of their occurrences; rather, it is a good indication that they are indeed postpositive.

### 5.2.3 Phonological incorporation (CRITERION 5)

Thanks to the metrical nature of Pindaric poems, it is possible to go further to prove the postpositive behavior of PRPs. Admittedly, the rhythm of the poetic meters used by Pindar is not a faithful image of the rhythm of spoken language; but it reflects to some extent the prosodic reality of AG. As Devine & Stephens (1994: 101) put it, “the rhythms of Greek verse are simply more highly constrained versions of rhythms already existing in Greek speech.” In particular, metrical texts allow us to recover prosodic breaks in the AG sentence.

AG verse is based on syllable weight: a line consists of a regulated alternation of heavy and light syllables (West 1983); within the line itself, the position of word-ends within a line is regulated as well.<sup>45</sup> The line is the domain where some sandhi processes apply, in particular avoidance of inter-word hiatus and inter-word resyllabification. As such, the line appears to be an idealized version of a phonological domain (the intonation unit), which can be subdivided in lower-rank phonological domains by cesurae (regular word-ends).

While such a view is quite straightforward in stichic poetry like Homer’s, where every line is metrically identical, in lyric poetry every poem has its own metrical design. However, the Pindaric odes are strophic poems: each one contains a number of so-called triads, consisting of three stanzas (called strophe, antistrophe and epode), the first two of which share the same

---

<sup>45</sup> Even though the textual tradition of Pindar’s poems divides the poems into *cola*, i.e. shorter metrical patterns, lines were recovered by Boeckh as early as 1811, who posited a line-end according to three criteria: obligatory word-end, *brevis in longo* (a light syllable counting as heavy) and possibility of inter-word hiatus.

metrical structure. This makes it possible to grade word-ends at any metrical position within the line: A strong break, for instance, will have word-end at most repetitions, whereas a weak break will only rarely allow a word-end. For every RP and every initial XP, a score was attributed by checking all other identical positions in the recurring metrical line. Every occurring word-end was graded 1; word-end involving a clitic (including prepositive and postpositive words) were graded .5; no word-end scored 0. The total score was then averaged over the number of identical lines in the poem. To give an example, the word-end before the PRP *hoí* in (34) is graded 45%, by comparison with all the recurring metrical lines in the poem (line 1 of the strophe and antistrophe): over the ten occurrences of this metrical pattern, a plain word-end occurs four times after the third syllable, and a word-end between prepositive and noun once.<sup>46</sup>

(34)	O. 2.1	anaksi:phórminges húmnoi	0	Strophe 1
	O. 2.8	kamóntes : <b>hoí</b> pollà thūmôî	1	Antristrophe 1
	O. 2.21	hótan the:ou Moíra pémpēi	0	Strophe 2
	O. 2.28	légonti -d' : en kai thalássai	1	Antristrophe 2
	O. 2.41	idoísa -d' : okseí' Erinús	1	Strophe 3
	O. 2.48	Olympí:ai -mèn -gàr autós	0	Antistrophe 3
	O. 2.61	ísais -dè : núktessin aieí	1	Strophe 4
	O. 2. 68	hósoi -d' eítólmāsan estrís	0	Antistrophe 4
	O. 2.81	hòs Hékto:ira sphāle, Troíās	0	Strophe 5
	O. 2.88	Diòs pròs- : órnikha theíon	.5	Antistrophe 5
	Score:		4.5/10	= 45%

**Figure 6** shows the prosodic behavior of PRP, IRP and initial XPs in the RCs in Pindar: line-internal breaks were split into strong and weak, with a 50% threshold.

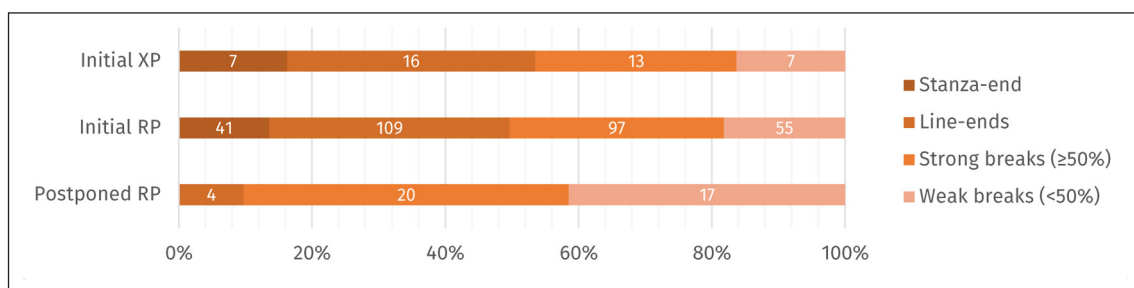

**Figure 6:** Line-ends and line-internal breaks.

<sup>46</sup> The dotted bar ':' indicates the equivalent position in each line. **Figure 6** reads like this: of all RCs with IRPs, the RP is at the beginning of a stanza 41 times, at the beginning of a line inside the stanza 109 times, after a strong break 97 times and after a weak break 55 times, and so on.

The association between the position within the RC and the strength of the preceding break is extremely robust.<sup>47</sup> PRPs never occur at the beginning of a stanza and only 4 times at the beginning of a line. This means that the prosodic cohesion with the preceding word is tighter with PRPs than with IRPs and initial XPs.<sup>48</sup> I take it as a strong indication that PRPs form a phonological unit with their host, which is to be expected if they are indeed postpositive words.<sup>49</sup>

Still, in contrast with usual postpositive words, which are never initial in a metrical line, PRPs do come first in the line four times in Pindar. Three occurrences involve a local adverbial RP, as in (35) (see also *hóthi* fr. 201.3 and *énthen* P. 5.79). Because of the scarcity of examples, however, it is difficult to know whether the adverbial nature of those PRPs has anything to do with their behavior.

- (35) Emàn | glôssan heurétō keladêtin,  
 my:ACC.SG tongue:ACC.SG find:IMP.PRS.3s sonorous:ACC.SG  
 [ Orsotriáinā | hín' en agôni baruktúpou |  
 wielder.of.the.trident:GEN.SG REL:where in joust:DAT.SG loud.thundering:GEN.SG  
 thálēse Korinthíois selínois ].  
 flourish:AOR.3s Corinthian:DAT.PL celery:DAT.PL  
 “Let him find my tongue sonorous, where in the joust of the loud-thundering Wielder of the Trident he covered himself in Corinthian celery.” (N. 4.85–88)

The fourth instance is potentially adverbial too, because it involves the neuter plural *hoîa*, which may have an adverbial force in AG (36); but in this interpretation, we are dealing here with a comparative clause rather than a RC.

- (36) Ouk émein' eltheîn trápezan numphían | oudè  
 NEG wait:AOR.3s come:INF.AOR table:ACC.SG of.bride:ACC.SG nor  
 pamphônōn iakhàn humenaíōn, [ hálíkes |  
 full.voiced:GEN.PL cry:ACC.SG of.marriage:GEN.PL of.the.same.age:NOM.PL  
**hoîa** parthénoi philéoisin hetairāi | hesperíais  
 REL:N.ACC.PL girl:NOM.PL love:PRS.3p companion:DAT.SG at.evening:DAT.PL  
 hupokourízesth' aoidaís ].  
 murmur:INF.PST song:DAT.PL  
 “She did not wait for the bride’s table to come, nor for the full-voiced marriage cry, such things that (or: as) girls her age love to murmur to their companion in their evening songs.” (P. 3.16–19)

<sup>47</sup>  $\chi^2(3) = 17.7, p < .001$  (PRPs vs. IRPs).

<sup>48</sup> At the RC edge, the difference between initial XPs and IRPs is not significant:  $\chi^2(3) = 1.46, p = .691$ .

<sup>49</sup> In Latin, PRPs occur exclusively in verse, as well as in Tocharian, where they are “a *marker* of poetry” (Adams 2015: 29, his emphasis): in both languages, the host of the PRP is as a rule located after the main caesura in the line (Hackstein 2015).

One can adduce another argument, namely that even well-behaved postpositives in AG have the ability to reverse their clitic polarity (Devine & Stephens 1994: 365–368; Goldstein 2015: 60–68; Pardal Padín 2015; 2017: 251–267), by forming a phonological word not with the preceding word, but with the following one.<sup>50</sup> Indications to that effect come from metrical caesurae, metrical bridges, and inscriptional punctuation. Crucially, however, the linear order is exactly the same as one would expect if the postpositive was enclitic. With that in mind, we could explain not only the rare examples of PRPs in initial position in the line, but also the ones occurring after a strong metrical break, the main point being that such a strategy is only marginal.

The results of sections 5.2.1–5.2.3 are summed up in **Table 6**, which clearly shows that PRPs meet all five criteria for postpositiveness.

<i>Criterion</i>	<i>Anaphoric pronouns</i>	<i>PRPs</i>
<i>Avoidance for first position</i>	+	±
<i>Sensitivity to prosodic/syntactic domain</i>	+	+
<i>Variable host selection</i>	+	+
<i>Domain interruption</i>	+	+
<i>Phonological incorporation</i>	+	+

**Table 6:** Criteria for postpositiveness.

### 5.3 Postpositive chains

Before proceeding to offer an explanation for the optional postpositive treatment of RPs, a potential difficulty with this approach needs to be addressed. In the Pindaric corpus, every second-position clausal clitic belonging to the RC is always located after the RP. While this is trivial with IRPs, it suggests that the PRP is at the leftmost boundary of the domain targeted by the clausal clitic. Occurrences are not very numerous, but they all pattern similarly, as shown by examples (37)–(39).

- (37) Temporal adverb *ἄποτε* (3×: see also fr. 52d.40–44 and P. 4.9–11 = (6) above)  
 en hâi kai tòn adeímanton Alkménā téken |  
 in REL:DAT.SG and ART:ACC.SG dauntless:ACC.SG Alcmena:NOM.SG bear:AOR.3s  
 paída<sub>i</sub> [ thraseíai tón<sub>i</sub> ἄποτε Gēruónā phrîksan  
 child:ACC.SG bold:NOM.PL REL:ACC.SG once Geryon:GEN.SG fear:AOR.3p

<sup>50</sup> Diachronically, clitic pronouns eventually became proclitic in most cases in Modern Greek (Horrocks 2010: 109).

kúnes ] .

dog:NOM.PL

“in which Alcmena bore the dauntless son as well whom once Geryon’s bold dogs feared.” (I. 1.12–13)

(38) Temporal adverb *εἰδῆ*

kheírôn áōton Blepsíadai<sub>i</sub> epínikon | [ héktos  
hand:GEN.PL flower:ACC.SG Blespiad:DAT.PL victorious:ACC.SG sixth:NOM.SG  
**hoís<sub>i</sub>** εἰδῆ stéphanos períkeitai phullophórōn ap’  
REL:DAT.PL now crown:NOM.SG embrace:PRS.3s full.of.leaves:GEN.PL from  
agónōn ] .

fight:GEN.PL

“the finest victory of hands for the Blepsians, whom the sixth garland now crowns because of their fights full of leaves.” (O. 8.75–76)

(39) Clitic pronoun *εσφιν*

Hoía Surākosiōn arkhōi<sub>i</sub> damasthéntes  
such:ACC.PL Syracusan:GEN.PL power:DAT.SG vainquish:PASS.PTCP.AOR.NOM.PL  
páthōn | [ ōkupórōn apò nāōn **hó<sub>i</sub>** εσφιν  
suffer:AOR.3p swift.sailing:GEN.PL from ship:GEN.PL REL:NOM.SG them:DAT.PL  
en póntōi báleth’ hālikíān ] .

in sea:DAT.SG throw:AOR.3s youth:ACC.SG

“Such were their sufferings once they were vanquished by the leader of the Syracusans, who from their rapid ships flung their youths into the sea.” (P. 1.73–74)

Although the data is scarce, it is noticeable that there is no example of the clausal clitic selecting the initial XP as its host, as shown in (40).

- (40) a. \* [ thraseíai *εpote* **tón**... (cf. (37) above)  
b. \* [ héktos *εἰδῆ* **hoís**... (cf. (38) above)  
c. \* [ ōkupórōn apò nāōn *εσφιν* **ho**... (cf. (39) above)  
d. \* [ ōkupórōn *εσφιν* apò nāōn **ho**... (cf. (39) above)

Now, in most languages, including AG, where clitics or postpositives can stack in the second position of a domain, their order is fixed, within each category (sentence-level, clause-level and phrase-level clitics) (Ruijgh 1991; Wills 1993; Soulétis-Julia 1998; Goldstein 2015: 86–91, with references). In AG, clause-level clitics appear in the following order (41):

- (41) Modal particles > Affirmative/temporal particles > Anaphoric pronouns > Indefinite adverbs > Indefinite pronouns

PRPs simply come first in that clitic chain, even before the modal particles *án* and *ke(n)*, which fits well their dual function: as they serve both as a pronoun and a complementizer, they are positioned closest to the Spec of the RC in which they occur, even after phonological movement to the second position in the linear word order.<sup>51</sup>

#### 5.4 Optionality of postponement

Now that it has been established, I hope, that the position of PRPs is the result of their postpositive treatment in AG phonology, the question of the optionality of this strategy comes to the fore. Granted, Pindar is not alone in allowing such variation: as we have seen time and again, other languages with PRPs, at least Indo-European ones, usually prefer the option of *wh*-movement for RPs (it is true of Latin, Tocharian, Vedic Sanskrit and Punjabi). Yet, postpositive words are generally defined as such in the lexicon. The question to be asked is why RPs can be treated, even marginally, as postpositive words, while they are usually initial in their clause.

The first thing to remember is that RPs always entertain a topic relation with the proposition expressed in the RC, as we said earlier (Section 4.2.3). Consequently, RPs cannot bear the nuclear stress of the RC (Matić 2003b: 313–314, on Modern Greek, Albanian and Serbo-Croatian). Moreover, when a language uses resumptive pronouns to express the syntactic function of the head within the RC, they are unaccented or clitic. Take (42a): as is regular for Albanian, the RC is headed by the invariable relative marker *që*, and the object function of the referent within the RC is expressed by the proclitic pronoun *e*, which is also the normal way of expressing a ratified topic (compare (42b)).

- (42) a. Çfarë përmban art-i [ që e krijoni ju ]?  
 what:ACC contain:PRS.1s art-the:NOM.SG REL it:ACC create:PRS.2s you:NOM  
 “What does the art which you create contain?” (after Matić 2003b: 316)
- b. E pashë.  
 she:ACC see:AOR.1s  
 “I saw her.”

It is thus a reasonable assumption that RPs are by nature RTop expressions. Now, in AG, RTop expressions are located immediately after the verb (recall (25) above), but they can also access higher positions in the clause (Matić 2003a: 597–598; Bertrand 2009; 2010: 212–214). Clitic pronouns are typically found in second position, that is, they select the first word of the clause as their host.

---

<sup>51</sup> In Vedic Sanskrit as well, which has clitic chains in clause-second position and non-initial RPs, the RP has a fixed position within such a chain (Hock 1992b; 1996).



Even non-pronominal RTop phrases are demoted phonologically in AG (Bertrand 2009). This explains why they can appear between the NFoc and the verb, which, as a rule, need to be contiguous. In (43), *brotoîs* is a ratified topic phrase intruding between the NFoc phrase *taûta* (a cataphoric pronoun), and the verb *légein*.

- (43) Theôn d' ephetmaîs Iksíona phanti (taûta)<sub>NFoc</sub>  
 god:GEN.PL CONN decree:DAT.PL Ixion:ACC.SG say:PRS.3p DEM:ACC.PL  
**brotoîs** | légein.  
 mortal:DAT.PL say:INF.PST  
 “Here is what, according to the decrees of the gods, Ixion is saying to the mortals.”  
 (P. 2.21–22)

Similarly, they can occur within another constituent, as *húmnon* in (44), which interrupts the NFoc *paídessin... Deinoméneos*.

- (44) parà dè tân eúudron aktàn Himérā  
 along CONN ART:ACC.SG good.water:ACC.SG shore:ACC.SG Himeras:GEN.SG  
 (paídessin **húmnon** Deinoméneos)<sub>NFoc</sub> telésais.  
 child:DAT.PL hymn:ACC.SG Deinomeneus:GEN.SG achieve:PTCP.AOR.NOM.SG  
 “along the good-water shore of the Himeras, achieving my hymn for the children of  
 Deinomeneus.” (P. 1.79)

They are, in effect, “derived clitics” (Fried 1999), which acquire their postpositive status from their informational function.

Turning back to RPs, this creates a conflict between the expression of information structure and syntactic alignment: *wh*-movement makes the RP raise to Spec, C<sub>h</sub>P, the highest position in their syntactic domain, while their RTop function makes them phonologically postpositive, and hence incapable of occupying the first position in their phonological domain. AG in general favored syntactic alignment, but, within one poetic tradition, lyric verse, the expression of information structure could optionally override it, with RPs treated as second-position clitics. When we approach PRPs as the imperfect resolution of a conflict between syntax and informationally driven prosody, we are in a better place to understand both why they are rare and why they remained optional in the development of AG.

## 6 Conclusion

As we have seen, PRPs are an exceptional phenomenon in AG: they are restricted to some poetic genres and attested over little more than two centuries before disappearing; and even in the texts where they occur, they do so rarely. RCs with PRPs are not different from regular RCs in terms of their semantics or their syntax, and structural arguments show that PRPs do not remain in

situ within the clause. Instead, they behave much like postpositive words, by selecting a host at the leftmost edge of their syntactic and prosodic domain and phonologically incorporating with that host. This behavior is typical of pronouns expressing a RTop in AG, and demonstrates the possibility, at least in verse, for phonology to outrank syntax.

If this explanation is correct, it opens avenues for future research: first, the restriction of PRPs to lyric and dramatic verse has yet to be understood more fully. The absence of PRPs in Homer is striking, because his language is, broadly speaking, more archaic than Pindar's: Thus, it is not a simple matter of diachrony. Of course, both poets operate in different poetic traditions, however indebted to epic (Homeric) poetry Pindar may have been (Nagy 1990). More research is needed to identify how genre influences syntax.

More broadly, what about the postponement of other complementizers, which cannot be explained by their informational status? It remains to be shown that this is the result of topicalization or focalization above the complementizer in every case. If not, how could we explain the position of the non-relative complementizer? Is it again a case of phonological demoting and postpositive treatment of the complementizer?

Another issue is to connect PRPs with another phenomenon at the phrase level, which is also virtually restricted to verse: the so-called anastrophe in PPs.<sup>52</sup> From Homer onwards, AG poetic language allows the order [Adjective Preposition Noun] or [Noun Preposition Adjective] in PPs (see for instance *kiónōn hūper Hērakléos* 'over the pillars of Herakles' in (9), *gaîan anà sphetērān* 'in their land' in (15) or *phullopórōn ap' agónōn* 'from the leave-bringing games' in (40) above). Again, as with PRPs and other postponed complementizers, the head of a phrase or clause is realized in second position. It is not yet clear if there is a common explanation uniting the three phenomena (postponement of RPs, complementizers, and prepositions), but it has been claimed that it was phonological in nature for PPs (Agbayani & Golston 2010). If this is true, more research is needed to understand why it is quite common in verse at the phrase level (with PPs) but rare at the clause level.

---

<sup>52</sup> Anastrophe also occurs with compound verbs, with phonological factors apparently playing an important role (Petit 2007).

## Abbreviations

1/2/3 = 1<sup>st</sup>/2<sup>nd</sup>/3<sup>rd</sup> person

ABL = ablative

ACC = accusative

ALL = allative

AOR = aorist

ART = article

COMP = complementizer

CONN = connective particle

DAT = dative

DEM = demonstrative

FUT = future

GEN = genitive

IMP = imperative

IMPF = imperfect

INDF = indefinite

INF = infinitive

LOC = locative

NEG = negation

NOM = nominative

OPT = optative

PASS = passive

PL/p = plural

PRF = perfect

PRS = present

PTC = particle

PTCP = participle

Q = interrogative

REL = relative

SBJV = subjunctive

SG/s = singular

VOC = vocative

## Additional file

The additional file for this article can be found as follows:

- **Bertrand 2023 When phonology outranks syntax (Data)**. This dataset contains all instances of relative pronouns in the surviving texts by Pindar, tagged according to their lexical, morphological, positional, syntactic, and semantic properties. All statistics in the current paper were extracted from this file. DOI: <https://doi.org/10.16995/glossa.9842.s1>

## Acknowledgements

A preliminary version of this paper was presented at the International Colloquium of Ancient Greek Linguistics in Madrid on June 17, 2022. I would like to thank the participants for their questions and remarks, as well as the anonymous reviewers for their thorough reading and insightful suggestions. I am also grateful to my colleagues at University Côte d'Azur in Nice for discussing the subject with me, especially Richard Faure, whose deep knowledge of AG syntax was an invaluable help at every step of the research process, and Amanda Edmonds, who kindly checked the statistics and my English style. All remaining errors are entirely mine.

## Competing interests

The author has no competing interests to declare.

---

## References

- Adams, Douglas Q. 1972. Relative clauses in ancient Greek. In Peranteau, Paul M. & Levi, Judith N. & Phares, Gloria C. (eds.), *The Chicago Which Hunt: Papers from the Relative Clause Festival, April 13, 1972, a Paravolume to papers from the Eighth Regional Meeting*, 9–22. Chicago: Chicago Linguistic Society.
- Adams, Douglas Q. 2015. *Tocharian B: A grammar of syntax and word-formation* (Innsbrucker Beiträge zur Sprachwissenschaft 151). Innsbruck: Institut für Sprachen und Literaturen der Universität Innsbruck.
- Agbayani, Brian & Golston, Chris. 2010. Phonological movement in Classical Greek. *Language* 86(1). 133–167. DOI: <https://doi.org/10.1353/lan.0.0186>
- Aldridge, Edith. 2010. Clause-internal *wh*-movement in archaic Chinese. *Journal of East Asian Linguistics* 19. 1–36. DOI: <https://doi.org/10.1007/s10831-009-9054-z>
- Bechtel, Friederich. 1963. *Die griechischen Dialekte*. Berlin: Weidmann.
- Becker, Kristina. 2014. *Zur Semantik der hethitischen Relativsätze* (Studien zur historisch-vergleichenden Sprachwissenschaft 5). Hamburg: Baar-Verlag.
- Bertrand, Nicolas. 2009. Les pronoms postpositifs dans l'ordre des mots en grec: Domaines syntaxiques, domaines pragmatiques. *Lalies* 29. 227–252. <https://hal.archives-ouvertes.fr/hal-01704032>.

- Bertrand, Nicolas. 2010. *L'ordre des mots chez Homère: Structure informationnelle, localisation et progression du récit*. Paris: Université Paris-Sorbonne dissertation (Faculté des Lettres). <https://hal.archives-ouvertes.fr/tel-01702387v1>.
- Bertrand, Nicolas & Faure, Richard. 2022. Wh-interrogatives in ancient Greek: Disentangling focus- and wh-movement. *Studia Linguistica* 76(3). 735–771. DOI: <https://doi.org/10.1111/stul.12194>
- Bresnan, Joan & Mchombo, Sam A. 1987. Topic, pronoun, and agreement in Chicheŵa. *Language* 63(4). 741–782. DOI: <https://doi.org/10.2307/415717>
- Buck, Carl Darling. 1928. *The Greek dialects: Grammar, selected inscriptions, glossary*. Chicago & London: University of Chicago Press.
- Chomsky, Noam. 1973. Conditions on transformations. In Anderson, Stephen R & Kiparsky, Paul (eds.), *A Festschrift for Morris Hal*, 232–286. New York: Holt, Rinehart & Winston.
- Christensen, Ken Ramshøj & Nyvad, Anne Mette. 2014. On the nature of escapable relative islands. *Nordic journal of linguistics* 37(1). 29–45. DOI: <https://doi.org/10.1017/S0332586514000055>
- Cinque, Guglielmo. 2020. *The syntax of relative clauses*. Cambridge: Cambridge University Press. DOI: <https://doi.org/10.1017/9781108856195>
- Danckaert, Lieven. 2012. *Latin embedded clauses: The left periphery* (Linguistik Aktuell/Linguistics Today 184). Amsterdam & Philadelphia: John Benjamins Publishing Company. DOI: <https://doi.org/10.1075/la.184>
- de Vries, Mark. 2002. *The syntax of relativization*. Utrecht: Universiteit van Amsterdam dissertation (Faculteit der Geesteswetenschappen). <https://hdl.handle.net/11370/996a2028-0dd5-471e-8891-da627229f8fa>.
- de Vries, Mark. 2005. The fall and rise of universals on relativization. *Journal of Universal Language* 6. 1–33. DOI: <https://doi.org/10.22425/jul.2005.6.1.125>
- de Vries, Mark. 2006. The syntax of appositive relativization: On specifying coordination, false free relatives, and promotion. *Linguistic Inquiry* 37(2). 229–270. DOI: <https://doi.org/10.1162/ling.2006.37.2.229>
- Demirok, Ömer. 2017. Free relatives and correlatives in wh-in-situ. In Lamont, Andrew & Tetzloff, Katerina (ed.), *Proceedings of NELS 47* (1), 271–284. Amherst: GLSA. <http://umass2016.nelsconference.org/wp-content/uploads/2016/09/demirok.pdf>.
- des Places, Édouard. 1947. *Le pronom chez Pindare: Recherches philologiques et critiques* (Études et Commentaires). Paris: Klincksieck.
- Devantier, Franz. 1886. *Über das lateinische sogenannte 'Relativum in der Verschränkung oder Konkurrenz'*. Friedeberg: Hahn'sche Verlags-Buchhandlung.
- Devine, Andrew Mackay & Stephens, Laurence D. 1994. *The prosody of Greek speech*. New York & Oxford: Oxford University Press.
- Devine, Andrew Mackay & Stephens, Laurence D. 2000. *Discontinuous syntax: Hyperbaton in Greek*. Oxford & New York: Oxford University Press.

- Dik, Helma. 1995. *Word order in ancient Greek: A pragmatic account of word order variation in Herodotus* (Amsterdam Studies in Classical Philology 5). Amsterdam: J.-C. Gieben. DOI: <https://doi.org/10.1163/9789004409002>
- Dik, Helma. 2007. *Word order in Greek tragic dialogue*. Oxford & New York: Oxford University Press. DOI: <https://doi.org/10.1093/acprof:oso/9780199279296.001.0001>
- Dover, Kenneth James. 1960. *Greek word order*. London: Bristol Classical Press.
- Fauconnier, Stefanie. 2014. Internal and external relative clauses in ancient Greek. *Journal of Greek Linguistics* 14(2). 141–162. DOI: <https://doi.org/10.1163/15699846-01402001>
- Faure, Richard. 2010. *Les subordinées interrogatives dans la prose grecque classique*. Paris: Université Paris-Sorbonne dissertation (Faculté des Lettres). <https://hal.archives-ouvertes.fr/tel-01369657/document>.
- Faure, Richard. 2015. Le couple ὄς/ὄστις en grec classique. *Glotta* 91. 62–89. DOI: <https://doi.org/10.13109/glot.2015.91e.1.62>
- Faure, Richard. 2021a. *Nominalization and referentiality of complement clauses, with special attention to classical Greek facts*. Paris: Sorbonne Université dissertation (Faculté des Lettres). DOI: <https://doi.org/10.13140/RG.2.2.27285.04323>
- Faure, Richard. 2021b. *The syntax and semantics of wh-clauses in classical Greek: Relatives, interrogatives, exclamatives* (The Language of Classical Literature 34). Leiden & Boston: E. J. Brill. DOI: <https://doi.org/10.1163/9789004467538>
- Fraenkel, Eduard. 1932. Kolon und Satz: Betrachtungen zur Gliederung des antiken Satzes, I. *Nachrichten von der Gesellschaft der Wissenschaften zu Göttingen*. Philologisch-Historische Klasse 1933. 197–213.
- Fraenkel, Eduard. 1933. Kolon und Satz: Betrachtungen zur Gliederung des antiken Satzes, II. *Nachrichten von der Gesellschaft der Wissenschaften zu Göttingen*. Philologisch-Historische Klasse 1933. 319–354.
- Fraenkel, Eduard. 1964. Nachträge zu ‘Kolon und Satz, II’. In Fraenkel, Eduard (ed.), *Kleine Beiträge zur klassischen Philologie* (Raccolta di studi e testi 95) (1), 131–139. Rome: Edizioni di Storia e Letteratura.
- Fraenkel, Eduard. 1965. *Noch einmal Kolon und Satz* (Sitzungsberichte der Bayerischen Akademie der Wissenschaften, Philosophisch-historische Klasse 1965, Heft 2). Munich: Verlag der Bayerischen Akademie der Wissenschaften.
- Fried, Mirjam. 1999. Inherent vs. derived clisis: Evidence from Czech proclitics. *Journal of Linguistics* 35. 43–64. DOI: <https://doi.org/10.1017/S0022226798007300>
- Garrett, Andrew. 1994. Relative clause syntax in Lycian and Hittite. *Die Sprache* 36(1). 26–69.
- Goldstein, David. 2014. Wackernagel’s Law I. In Giannakis, Giorgios K (ed.), *Encyclopaedia of Greek Language and Linguistics* (3), 508–513. Leiden: E. J. Brill. DOI: [https://doi.org/10.1163/2214-448X\\_eagll\\_COM\\_00000375](https://doi.org/10.1163/2214-448X_eagll_COM_00000375)
- Goldstein, David. 2015. *Classical Greek syntax: Wackernagel’s law in Herodotus* (Brill’s Studies in Indo-European Languages & Linguistics 16). Leiden & Boston: E. J. Brill. DOI: <https://doi.org/10.1163/9789004250680>

- Grosu, Alexander & Landman, Fred. 1998. Strange relatives of the third kind. *Natural language semantics* 6(2). 125–170. DOI: <https://doi.org/10.1023/A:1008268401837>
- Guardiano, Cristina. 2013. The Greek definite article across time. *Studies in Greek linguistics* 33. 76–91. <http://hdl.handle.net/11380/1000532>.
- Haberland, Hartmut & van den Auwera, Johan. 1990. Topics and clitics in Greek relatives. *Acta Linguistica Hafniensia* 22(1). 127–157. DOI: <https://doi.org/10.1080/03740463.1990.10411525>
- Hackstein, Olav. 2010. *Apposition and nominal classification in Indo-European and beyond* (Sitzungsberichte der philologisch-historischen Klasse 798, Veröffentlichungen zur Iranistik 56). Vienna: Verlag der Österreichischen Akademie der Wissenschaften. DOI: <https://doi.org/10.1553/0x0022e0c5>
- Hackstein, Olav. 2015. The word-order patterns *Troiae qui primus ab oris* and *summa cum dignitate* in Latin and Tocharian. In Malzahn, Melanie & Peyrot, Michaël & Fellner, Hannes & Illés, Theresa-Susanna (eds.), *Tocharian texts in context: International Conference on Tocharian Manuscripts and Silk Road Culture, Vienna, June 25–29th, 2013*, 73–86. Bremen: Hempen.
- Hajdú, István. 1989. *Über die Stellung der Enklitika und Quasi-Enklitika bei Pindar und Bakchylides*. Lund: Studentlitteratur.
- Held, Warren H., Jr. 1957. The Hittite relative sentence. *Language* 33(4, part 2: Language dissertation). 3–52. DOI: <https://doi.org/10.1515/9781614512950>
- Hock, Hans Heinrich. 1992a. Some peculiarities of Vedic-prose relative clauses. *Wiener Zeitschrift für die Kunde Südasiens* 36 (Proceedings of the VIIIth World Sanskrit Conference Vienna 1990). 19–29.
- Hock, Hans Heinrich. 1992b. What's a nice word like you doing in a place like this? Syntax vs. phonological form. *Studies in the Linguistic Sciences* 22. 39–87.
- Hock, Hans Heinrich. 1996. Who's on first: toward a prosodic account of P2 clitics. In Halpern, Aaron L & Zwicky, Arnold M (eds.), *Approaching second: second position clitics and related phenomena* (CSLI lecture notes), 199–270. Stanford: CSLI Publications.
- Hock, Hans Heinrich. 2000. Genre, discourse and syntax in early Indo-European, with emphasis on Sanskrit. In Herring, Susan C & van Reenen, Pieter & Schøsler, Lene (eds.), *Textual parameters in older languages* (Amsterdam Studies in the Theory and History of Linguistic Science, Series IV: Current Issues in Linguistic Theory 195). 163–195. Amsterdam & Philadelphia: John Benjamins Publishing Company. DOI: <https://doi.org/10.1075/cilt.195.09hoc>
- Hoffner, Harry A., Jr & Melchert, H. Craig. 2008. *A grammar of the Hittite language* (Languages of the Ancient Near East 1). Winona Lake, Indiana: Eisenbrauns. DOI: <https://doi.org/10.5325/j.ctv240djsf>
- Horrocks, Geoffrey C. 2010. *Greek: A history of the language and its speakers*. Wiley–Blackwell Publishing. DOI: <https://doi.org/10.1002/9781444318913>
- Huggard, Mattyas George Charles. 2015. *Wh-words in Hittite: A study in syntax-semantics and syntax-phonology interfaces*. Los Angeles: University of California dissertation. <https://escholarship.org/uc/item/1gb9f3dg>.

- Hummel, Pascale. 1993. *La syntaxe de Pindare* (Bibliothèque de l'Information Grammaticale 24). Paris & Leuven: Peeters.
- Hummel, Pascale. 2001. Polysyntaxe et polysémie dans la poésie de Pindare. *Quaderni Urbinati di Cultura Classica* 68(2). 41–48. DOI: <https://doi.org/10.2307/20546680>
- Kannicht, Richard. 2004. *Tragicorum Graecorum Fragmenta*. Göttingen: Vandenhoeck & Ruprecht. DOI: <https://doi.org/10.13109/9783666257551>
- Keenan, Edward L & Comrie, Bernard. 1977. Noun phrase accessibility and universal grammar. *Linguistic Inquiry* 8(1). 63–99. DOI: <https://doi.org/10.4324/9781315880259-11>
- Kühner, Raphael & Gerth, Bernhard. 1890–1904. *Ausführliche Grammatik der griechischen Sprache*. Hanover & Leipzig: Hahn'sche Verlags-Buchhandlung.
- Kuno, Susumu. 1976. Subject, theme and the speaker's empathy: A reexamination of relativization phenomena. In Li, Charles N. (ed.), *Subject and topic*, 417–444. New York, San Francisco & London: Academic Press.
- Lambrecht, Knud. 1994. *Information structure and sentence form: Topic, focus, and the mental representations of discourse referents* (Cambridge Studies in Linguistics 71). Cambridge & New York: Cambridge University Press. DOI: <https://doi.org/10.1017/CBO9780511620607>
- Lambrecht, Knud & Michaelis, Laura A. 1998. Sentence accent in information questions: Default and projection. *Linguistics and Philosophy* 21(5). 477–544. DOI: <https://doi.org/10.1023/A:1005327212709>
- Lau, Elaine & Tanaka, Nozomi. 2021. The subject advantage in relative clauses: A review. *Glossa* 6(1). 1–34. DOI: <https://doi.org/10.5334/gjgl.1343>
- Lauer, Simon. 1959. *Zur Wortstellung bei Pindar*. Winterthur: P. G. Keller.
- Lehmann, Christian. 1984. *Der Relativsatz: Typologie seiner Strukturen, Theorie seiner Funktionen, Kompendium seiner Grammatik* (Language Universals 3). Tübingen: Gunter Narr Verlag.
- Lehmann, Christian. 1986. On the typology of relative clauses. *Linguistics* 24. 663–680. DOI: <https://doi.org/10.1515/ling.1986.24.4.663>
- Lühr, Rosemarie. 2001. Relativsätze im Hethitischen. In Gernot, Wilhelm (ed.), *Akten des IV. Internationalen Kongresses für Hethitologie Würzburg, 4.–8. Oktober 1999* (Studien zu den Boğazköy-Texten 45). 333–346. Wiesbaden: Harassowitz Verlag. [https://dwee.saw-leipzig.de/Rosemarie\\_Luehr/userfiles/downloads/Sonderdruck94.pdf](https://dwee.saw-leipzig.de/Rosemarie_Luehr/userfiles/downloads/Sonderdruck94.pdf).
- Luraghi, Silvia. 2003a. Definite referential null objects in Ancient Greek. *Indogermanische Forschungen* 108. 167–194. DOI: <https://doi.org/10.1515/9783110243482.167>
- Luraghi, Silvia. 2003b. *On the meaning of prepositions and cases in ancient Greek* (Studies in Language Companion 67). Amsterdam & Philadelphia: John Benjamins Publishing Company. DOI: <https://doi.org/10.1075/slcs.67>
- Maehler, Herwig & Snell, Bruno. 1980. *Pindari carmina cum fragmentis* (Bibliothecae Teubnerianae Huius Temporis). Leipzig: B. G. Teubner.
- Manolessou, Io & Horrocks, Geoffrey C. 2007. The development of the definite article in Greek. *Studies in Greek linguistics* 27. 224–236.



- Matić, Dejan. 2003a. Topic, focus, and discourse structure: Ancient Greek word order. *Studies in Language* 27(3). 573–633. DOI: <https://doi.org/10.1075/sl.27.3.05mat>
- Matić, Dejan. 2003b. *Topics, presuppositions, and theticity: An empirical study of verb-subject clauses in Albanian, Greek, and Serbo-Croat*. Cologne: Universität zu Köln dissertation (Institut für Sprachwissenschaft). <https://kups.ub.uni-koeln.de/1132/1/DISS.pdf>.
- Maxwell, Daniel N. 1979. Strategies of relativization and NP accessibility. *Language* 55(2). 352–371. DOI: <https://doi.org/10.2307/412589>
- Miller, D. Gary. 2014. *Ancient Greek dialects and early authors: Introduction to the dialect mixture in Homer, with notes on lyric and Herodotus*. Boston & Berlin: De Gruyter. DOI: <https://doi.org/10.1515/9781614512950>
- Monteil, Pierre. 1963. *La phrase relative en grec ancien: Sa formation, son développement, sa structure, des origines à la fin du V<sup>e</sup> s. A. C.* (Études et Commentaires 47). Paris: Klincksieck.
- Nagy, Gregory. 1990. *Pindar's Homer: The lyric possession of an epic past*. Baltimore: Johns Hopkins University Press. [http://nrs.harvard.edu/urn-3:hul.ebook:CHS\\_Nagy.Pindars\\_Homer.1990](http://nrs.harvard.edu/urn-3:hul.ebook:CHS_Nagy.Pindars_Homer.1990).
- Pardal Padín, Alberto. 2015. La proclisis de los pronombres personales átonos en el teatro ático clásico. In de la Villa, Jesús & Cañizares Ferriz, Patricia & Falque Rey, Emma & González Castro, José Francisco & Siles Ruiz, Jaime (eds.), *Ianua Classicorum. Temas y formas del mundo clásico* (1), 589–598. Madrid: Sociedad Española de Estudios Clásicos.
- Pardal Padín, Alberto. 2017. *La interacción entre fonología y sintaxis en griego antiguo*. Madrid: Universidad Autónoma de Madrid dissertation (Facultad de Filosofía y Letras, Departamento de Filología Clásica). <http://hdl.handle.net/10486/680639>.
- Perna, Elena. 2013. *La frase relativa in greco antico: Analisi sintattica basata sul dialetto attico di Platone*. Padova: Università degli Studi di Padova dissertation (Dipartimento di Studi Linguistici e Letterari). <https://www.research.unipd.it/handle/11577/3423611>.
- Petit, Daniel. 2007. L'anastrophe verbale en grec archaïque: Entre syntaxe et poétique. In Blanc, Alain & Dupraz, Emmanuel (eds.), *Procédés synchroniques de la langue poétique en grec et en latin* (Langues et cultures anciennes 9), 191–214. Brussels: Éditions Safran.
- Probert, Philomen. 2015. *Early Greek relative clauses*. Oxford & New York: Oxford University Press. DOI: <https://doi.org/10.1093/acprof:oso/9780198713821.001.0001>
- Rizzi, Luigi. 1997. The fine structure of the left periphery. In Haegeman, Liliane (ed.), *Elements of grammar: handbook in Generative Syntax* (Kluwer International Handbooks of Linguistics 1), 281–337. Dordrecht: Kluwer Academic Publishers. DOI: [https://doi.org/10.1007/978-94-011-5420-8\\_7](https://doi.org/10.1007/978-94-011-5420-8_7)
- Ruijgh, Cornelis Jord. 1971. *Autour de "τε épique": Études sur la syntaxe grecque*. Amsterdam: Adolf M. Hakkert.
- Ruijgh, Cornelis Jord. 1991. La place des enclitiques dans l'ordre des mots chez Homère d'après la loi de Wackernagel. In Eichner, Heiner & Rix, Helmut (eds.), *Sprachwissenschaft und Philologie: Jacob Wackernagel und die Indogermanische heute. Kolloquium der Indogermanische Gesellschaft vom 13. bis 15. Oktober 1988 in Basel*, 213–233. Wiesbaden: L. Reichert.

- Scheppers, Frank. 2011. *The colon hypothesis: Word order, discourse segmentation and discourse coherence in ancient Greek*. Brussels: VUBPress.
- Sichel, Ivy. 2018. Anatomy of a counterexample: Extraction from relative clauses. *Linguistic Inquiry* 49(2). 335–378. DOI: [https://doi.org/10.1162/LING\\_a\\_00275](https://doi.org/10.1162/LING_a_00275)
- Sideltsev, Andrej V. 2015. Hittite clause architecture. *Revue d'assyriologie et d'archéologie orientale* 109(1). 79–112. DOI: <https://doi.org/10.3917/assy.109.0079>
- Silk, Michael Stephen. 2010. The language of Greek lyric poetry. In Bakker, Egbert Jan (ed.), *A companion to the ancient Greek language*, 424–440. Malden: Wiley–Blackwell Publishing. DOI: <https://doi.org/10.1002/9781444317398.ch28>
- Slater, William J. 1969. *Lexicon to Pindar*. Berlin: Walter de Gruyter. DOI: <https://doi.org/10.1515/9783110839289>
- Soulétis-Julia, Marie-Ange. 1998. *Chaînes pronominales dans l'Iliade: Ordre fixe, variations d'ordre et fonctions de quelques particules*. Paris: École Pratique des Hautes Études dissertation (IV<sup>e</sup> Section: Sciences historiques et philologiques).
- Tribulato, Olga. 2010. Literary dialects. In Bakker, Egbert Jan (ed.), *A companion to the ancient Greek language* (Blackwell Companions to the Ancient World), 388–400. Malden: Wiley–Blackwell Publishing. DOI: <https://doi.org/10.1002/9781444317398.ch26>
- Usener, Hermann & Radermacher, Ludwig. 1929. *Dionysii Halicarnasei quae exstant* (Bibliotheca Tubneriana scriptorum Graecorum et Romanorum). Leipzig: B. G. Teubner.
- Verdier, Christian. 1972. *Les éolismes non-épiques dans la langue de Pindare*. Innsbruck: Institut für Vergleichende Sprachwissenschaft der Universität Innsbruck.
- Wackernagel, Jacob. 1892. Über ein Gesetz der indogermanischen Wortstellung. *Indogermanische Forschungen* 1. 333–486. DOI: <https://doi.org/10.1515/9783110242430.333>
- West, Martin Litchfield. 1974. *Studies in Greek elegy and iambus* (Untersuchungen zur antiken Literatur und Geschichte 14). Berlin & New York: Walter de Gruyter. DOI: <https://doi.org/10.1515/9783110833188>
- West, Martin Litchfield. 1983. *Greek metre*. Oxford: Clarendon Press.
- Wills, Jeffrey. 1993. Homeric particle order. *Historische Sprachforschung* 106(1). 61–81. <https://www.jstor.org/stable/40849081>.
- Yang, Henrietta. 2006. On overt and covert *wh*- and relative movement in Hindi and Punjabi. In Cheng, Lisa Lai-Shen & Corver, Norbert (eds.), *Wh-Movement: Moving On*, 135–164. Cambridge: Massachusetts Institute of Technology Press. DOI: <https://doi.org/10.7551/mitpress/7197.003.0011>
- Zhao, Chen & Zhang, Futong. 2022. Relative clauses in Archaic Chinese. *Journal of Chinese Linguistics* 50(2). 385–418. DOI: <https://doi.org/10.1353/jcl.2022.0015>

