



HAL
open science

Quantification of the chemical reactor reliability in the presence of uncertainties/errors in input parameters

Nouha Lyagoubi, Lamiae Vernieres-Hassimi, Leila Khalij, Lionel Estel

► To cite this version:

Nouha Lyagoubi, Lamiae Vernieres-Hassimi, Leila Khalij, Lionel Estel. Quantification of the chemical reactor reliability in the presence of uncertainties/errors in input parameters. *Journal of Loss Prevention in the Process Industries*, 2022, 76, pp.104751. 10.1016/j.jlp.2022.104751 . hal-04098973

HAL Id: hal-04098973

<https://hal.science/hal-04098973v1>

Submitted on 22 Jul 2024

HAL is a multi-disciplinary open access archive for the deposit and dissemination of scientific research documents, whether they are published or not. The documents may come from teaching and research institutions in France or abroad, or from public or private research centers.

L'archive ouverte pluridisciplinaire **HAL**, est destinée au dépôt et à la diffusion de documents scientifiques de niveau recherche, publiés ou non, émanant des établissements d'enseignement et de recherche français ou étrangers, des laboratoires publics ou privés.



Distributed under a Creative Commons Attribution - NonCommercial 4.0 International License

Quantification of the chemical reactor reliability in the presence of uncertainties/errors in input parameters

Nouha LYAGOUBI¹, Lamiae VERNIERES-HASSIMI^{1,*}, Leila KHALIJ², Lionel ESTEL¹

¹ Normandie Université, LSPC/INSA Rouen, 76000 Rouen, France

² Normandie Université, LMN/INSA Rouen, 76000 Rouen, France

* Corresponding author: lamiae.vernieres@insa-rouen.fr

Abstract

Errors and uncertainties in the input parameters can have a significant effect on the reliability, quality and safety of a chemical process. However, the majority of mathematical models use deterministic operating conditions. Therefore, to have a more realistic mathematical design, it is essential to take them into account in order to analyse how they propagate in a chemical reactor and influence the safety criteria.

In this work, random variations were imposed on the input parameters of a batch chemical reactor and the impact on the system reliability was studied. An exothermic reaction of the synthesis of peroxyformic acid was chosen and the maximum temperature of this reaction was taken as a safety criterion. The case of impurity presence in the reactor was also investigated. This impurity can lead to the reactant decomposition and consequently to thermal runaway, despite the adequate setting of the operating conditions.

The probability density functions (PDFs) for the reaction maximum temperature were used to estimate the system reliability. These PDFs were obtained by solving Latin hypercube sampling and genetic algorithm combined with the least square method. Stochastic treatment provides a more significant information concerning the reliability and highlights the nonlinearity of the process.

Keywords: Thermal runaway, Chemical reactor, Uncertainty propagation, Uncertainty quantification, Process uncertainty

Nomenclature

E_a^y	Activation energy of y ($\text{J}\cdot\text{mol}^{-1}$)	y	For the reaction <i>perh</i> or <i>dec, 1</i> or <i>dec, 2</i>
k_0^y	Pre-exponential factor of y	K_{FAD}^C	Formic acid dissociation constant fixed at $2.9 \cdot 10^{-6}$ (dimensionless)
n	Number of simulations	R	Ideal gas constant ($\text{J}\cdot\text{mol}^{-1}\cdot\text{K}^{-1}$)
T_j	Coolant temperature ($^{\circ}\text{C}$)	T_r	Reaction temperature ($^{\circ}\text{C}$)
T_{max}	Maximum temperature ($^{\circ}\text{C}$)	T_{ref}	Reference temperature ($^{\circ}\text{C}$)
ΔH_r^{perh}	Molar enthalpy of formic acid perhydrolysis reaction ($\text{J}\cdot\text{mol}^{-1}$)	K^C	Equilibrium constant of the perhydrolysis formic acid reaction
<i>perh</i>	Perhydrolysis reaction of formic acid	[·]	Concentration of chemical compound ($\text{mol}\cdot\text{L}^{-1}$)
<i>dec, 1</i>	Decomposition reaction of PFA into CO_2 and H_2O	R_r^y	Reaction velocity of y ($\text{mol}\cdot\text{L}^{-1}\cdot\text{s}^{-1}$)
<i>dec, 2</i>	Decomposition reaction of PFA to FA and O_2	<i>dec, 3</i>	Decomposition reaction of H_2O_2 into O_2 and HO_2
<i>spont</i>	Spontaneous decomposition	<i>cat</i>	Catalyzed reaction

Abbreviations

CDF	Cumulative Distribution Function	FA	Formic Acid
HP	Hydrogen Peroxide	LHS	Latin Hypercube Sampling
MC	Monte Carlo	PDF	Probability Density Function
PFA	PeroxyFormic Acid	RC1	Calorimetric Reactor
GEV	Generalized extreme value distribution	GGD	Generalized Gaussian Distribution

Greek symbols

α	Scale parameter (GGD)	μ	Location parameter (GEV & GGD)
β	Shape parameter (GGD)	ξ	Shape parameter (GEV)
σ	Scale parameter	Γ	Gamma function
γ	Incomplete Gamma function		

1. Introduction

The chemical industry is often exposed to risks that can cause serious accidents in extreme cases. These accidents generate human, financial, environmental and other damages. One of the main reasons for accidents in the chemical industry is the phenomenon of thermal runaway. This phenomenon represents 25% of accidents at the chemical industry in France (Dakkoune, et al., 2019) and 26.5% of the petrochemical industry in the United States (Balasubramanian & Louvar, 2004). It occurs when the heat flow produced by chemical reactions exceeds the heat removed by the cooling system (Stoessel, 2008). (Dakkoune, et al., 2018) have identified three cause types leading to this phenomenon in French chemical industry:

- human and organizational such as operator errors, insufficient training, lack of process knowledge, etc. These causes account for about 55.81%;
- technical and physical such as equipment failure, poor design, etc. These causes represent about 41.3%;
- natural such as lightning, floods, earthquakes etc. These causes account for about 2.89%.

In order to detect this phenomenon in a chemical process, it is essential to determine safety criteria to provide early warning of a possible risk. Several criteria have been proposed in the literature, we can cite the one developed by (Thomas & Bowes, 1961) based on the second derivative of the reactor temperature (Casson, et al., 2012), the adiabatic temperature of the synthesis reaction and the time required to reach the maximum temperature under adiabatic conditions developed by (Stoessel, 2009), or the maximum temperature of the reaction studied by (Vernières-Hassimi & Leveneur, 2015; Vernières-Hassimi, et al., 2016; Zhang, et al., 2017). This maximum temperature is sensitive to the operating conditions and takes into account the temperature threshold that must not be exceeded to avoid triggering side reactions.

Errors and uncertainties made on the operating conditions can have a significant effect on the reliability, quality and safety of a chemical process (Ali, et al., 2018). However, the majority of mathematical models and simulations use deterministic operating conditions (Abubakar, et al., 2015; Duong, et al., 2016). Therefore, to have a more realistic mathematical design, it is essential to take the main sources of uncertainty into account in order to analyse how this uncertainty propagates in a chemical reactor. Thus, we have studied in this work, the impact

of the operating conditions variations on the reactor reliability. This reliability is obtained from the Probability Density Functions (PDF) of the reaction maximum temperature. The reaction chosen is an exothermic reaction between hydrogen peroxide and formic acid.

First the reactor and the chemical reaction are described. Then, the methodology followed to study the reactor uncertainties is detailed. In the last part, an evaluation is carried out to estimate the reactor reliability according to different input parameters.

2. Experimental set-up description and the mathematical model of the chemical reaction

2.1. Experimental device

The device used for the experimental validation is the RC1 reactor represented in Figure 1.

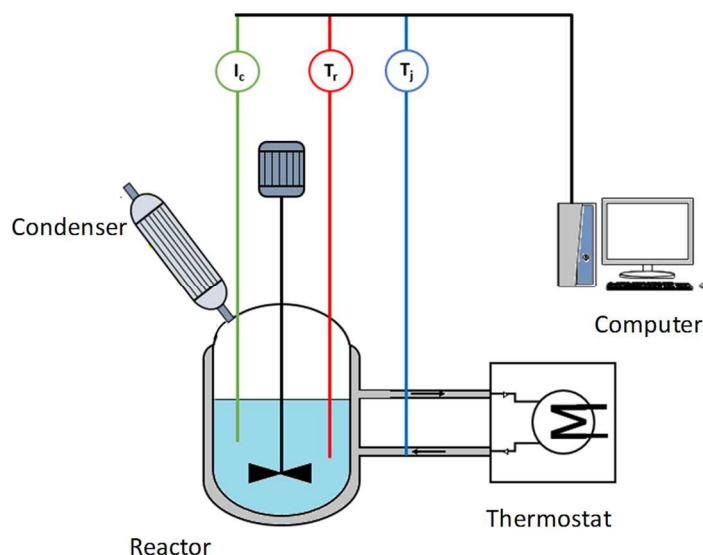

Figure 1. Schematic illustration of a pilot reactor METTLER RC1

The main installation consists of a jacketed reactor with a multi-port cover that simplifies the passage of the stirrer shaft, temperature and calibration probes, and the condenser maintaining a constant density.

The stirred tank is made of glass with a capacity of 2 L, equipped with a double-jacket mono-fluid heating/cooling system circulating the heat-transfer fluid (47V20 silicone oil) with a fixed flow rate of $1.33 \text{ kg}\cdot\text{s}^{-1}$. The aim is to maintain a uniform temperature in the double jacket.

Mechanical agitation is chosen in order to obtain a homogeneous mixture.

2.2. Mathematical model of the chemical reaction

The chemical reaction is the peroxyformic acid (PFA) synthesis from formic acid (FA) and hydrogen peroxide (HP). We chose this reaction because of its exothermicity and the presence of hydrogen peroxide as a reagent, which is subject to decomposition due to temperature or the presence of impurities. The reaction kinetics have been studied in previous works (Zheng, et al., 2016; Vernières-Hassimi, et al., 2017) and the reaction mechanism is given in Figure 2.

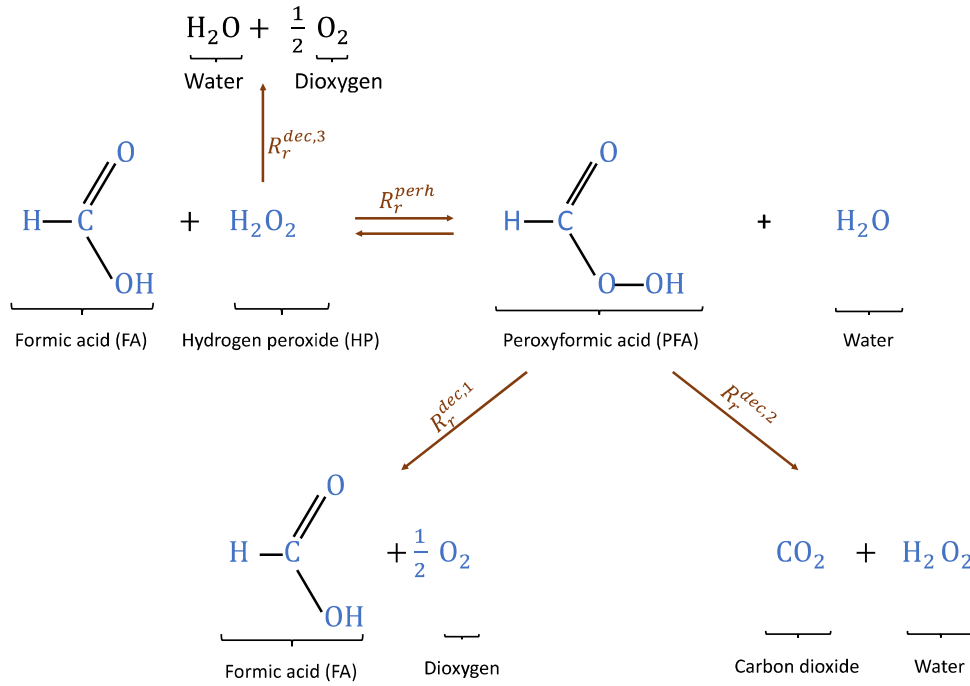

Figure 2. Simplified mechanism of the formic acid perhydrolysis reaction

Thus, the mathematical model in a batch reactor is given by the following balancing chemical equations:

$$\left\{ \begin{array}{l} \frac{dC_{\text{HCOOH}}}{dt} = -R_r^{perh} + R_r^{dec,1} \\ \frac{dC_{\text{HCOOOH}}}{dt} = R_r^{perh} - R_r^{dec,1} - R_r^{dec,2} \\ \frac{dC_{\text{H}_2\text{O}_2}}{dt} = -R_r^{perh} - R_r^{dec,3} \\ \frac{dC_{\text{H}_2\text{O}}}{dt} = R_r^{perh} + R_r^{dec,1} + R_r^{dec,3} \end{array} \right. \quad (1)$$

The kinetic expression of the perhydrolysis reaction denoted R_r^{perh} is determined by:

$$R_r^{perh} = k_0^{perh} \exp\left(\frac{-E_a^{perh}}{R} \left(\frac{1}{T_r} - \frac{1}{T_{ref}}\right)\right) \sqrt{K_{FAD}^C \frac{[\text{HCOOH}]}{[\text{H}_2\text{O}]}} \left([\text{HCOOH}][\text{H}_2\text{O}_2] - \frac{1}{K^C} [\text{HCOOOH}][\text{H}_2\text{O}]\right) \quad (2)$$

The equilibrium constant expression of the perhydrolysis reaction of the FA denoted K^C is given by the Van't Hoff law such as:

$$K^C = K_{ref}^C \exp\left(\frac{-\Delta H_r^{perh}}{R} \left(\frac{1}{T} - \frac{1}{T_{ref}}\right)\right) \quad (3)$$

with $K_{ref}^C = 0.96$ (dimensionless) at $T_{ref} = 30^\circ\text{C}$.

The main reaction is characterized by the presence of three parallel secondary reactions of decomposition according to Eqs. (4 - 6):

1) The PFA decomposition into formic acid and oxygen. The kinetic expression of this reaction is defined by:

$$R_r^{dec,1} = k_0^{dec,1} \exp\left[\frac{-E_a^{dec,1}}{R} \left(\frac{1}{T_r} - \frac{1}{T_{ref}}\right)\right] [\text{HCOOOH}] \quad (4)$$

2) The PFA decomposition into carbon dioxide and water. The related kinetic expression is given by:

$$R_r^{dec,2} = k_0^{dec,2} \exp\left[\frac{-E_a^{dec,2}}{R} \left(\frac{1}{T_r} - \frac{1}{T_{ref}}\right)\right] [\text{HCOOOH}] \quad (5)$$

All the kinetic parameters of Eqs. (3), (4) and (5) are reported in Table 1.

Kinetic parameters	k_0^{perh} $L \cdot mol^{-1} \cdot s^{-1}$	E_a^{perh} $J \cdot mol^{-1}$	$k_0^{dec,1}$ s^{-1}	$E_a^{dec,1}$ $J \cdot mol^{-1}$	$k_0^{dec,2}$ s^{-1}	$E_a^{dec,2}$ $J \cdot mol^{-1}$
Values	0.15	150000	0.001	20000	0.0009	20200

The unit of k_0^{perh} depends on the reaction order

Table 1. Values of kinetic parameters for $T_{ref} = 67^\circ\text{C}$ (Zheng, et al., 2016)

3) The hydrogen peroxide decomposition into dioxygen and water. The related kinetic expression is given by:

$$R_r^{dec,3} = R_r^{spont} + R_r^{cat} \quad (6)$$

with

$$R_r^{spont} = k^{spont} [\text{H}_2\text{O}_2] \quad (7)$$

$$k^{spont} = k_0^{spont} * \exp\left[\frac{-E_a^{spont}}{R} \left(\frac{1}{T_R} - \frac{1}{T_{ref}}\right)\right] \quad (8)$$

The hydrogen peroxide decomposition by the copper (II) sulfate (CuSO_4) involves a complex mechanism. According to (Perez-Benito, 2001), the detailed kinetic of the decomposition catalyzed by copper (II) sulfate (R_r^{cat}) can be expressed by:

$$R_r^{cat} = 2k^{cat,A}[\text{Cu}^{2+}][\text{H}_2\text{O}_2]^2 + 2k^{cat,B}[\text{Cu}^{2+}]^{\frac{1}{2}}[\text{H}_2\text{O}_2] \quad (9)$$

with

$$k^{cat} = k_{ref} \exp\left(\frac{-E_a^{cat}}{R}\left(\frac{1}{T} - \frac{1}{T_{ref}}\right)\right) \quad (10)$$

$$k_{ref} = k_0^{cat} \cdot \exp\left(\frac{-k_0^{cat}}{RT_{ref}}\right) \quad (11)$$

$k^{cat,A}$ and $k^{cat,B}$ are two velocity constants. The kinetic and thermodynamic parameters are reported in Table 2.

	k_0^{spont} s^{-1}	E_a^{spont} $\text{J} \cdot \text{mol}^{-1}$	$k_0^{cat,A}$ $\text{L}^2 \cdot \text{mol}^{-2} \cdot \text{s}^{-1}$	$E_a^{cat,A}$ $\text{J} \cdot \text{mol}^{-1}$	$k_0^{cat,B}$ $\text{L}^{1/2} \cdot \text{mol}^{-1/2} \cdot \text{s}^{-1}$	$E_a^{cat,B}$ $\text{J} \cdot \text{mol}^{-1}$
Values	9.24×10^{-5}	1.5×10^5	0.163×10^{-1}	1.62×10^5	0.35×10^{-2}	6.97×10^4

Table 2. Estimated parameters and statistical data at $T_{ref} = 413\text{K}$ for the spontaneous decomposition of hydrogen peroxide (Vernières-Hassimi, et al., 2017)

The thermal balance is obtained from:

$$\frac{dT_r}{dt} = \frac{1}{\sum m_r C_{pr}} (UA(T_j - T_r) - \sum R_r \cdot \Delta H_r^y \cdot V_r - q_{loss}) \quad (12)$$

m_r and C_{pr} are respectively the initial mass and the heat capacity of the reaction mixture. U value is the overall heat transfer coefficient, A the heat transfer area, T_j is the coolant temperature, V_r is the volume of the reaction mixture, q_{loss} is the heat loss due to evaporation given by (Dakkoune, et al., 2020). The enthalpies of the different reactions ΔH_r^y are given in Table 3.

	Reaction name y				
Reaction enthalpy ($\text{J} \cdot \text{mol}^{-1}$)	ΔH_r^{perh} (Zheng, et al., 2016)	$\Delta H_r^{dec,1}$	$\Delta H_r^{dec,2}$	$\Delta H_r^{dec,3}$ (spont) (Marzacco, 1999; Tatsuoka & Koga, 2013)	$\Delta H_r^{dec,3}$ (with CuSO₄) (Vernières-Hassimi, et al., 2017)
Values ($\times 10^3$)	-5.58	-359	-163	-98	-93.2

Table 3. The thermodynamic parameters of Eq. (12)

This mathematical model has been experimentally validated in (Dakkoune, et al., 2020; Dakkoune, et al., 2019; Dakkoune, et al., 2018).

3. Description of the approach

To study the propagation of the input parameters uncertainties on the reactor output, the flowchart of the method is described in Figure 3. The output parameter considered in this work is the maximum reaction temperature. The main objective of the applied method is to evaluate the reactor reliability according to the input parameters variation, studied simultaneously or independently. The input parameters are the coolant temperature (T_j), the concentrations of the hydrogen peroxide (HP), the formic acid (FA) and the CuSO_4 impurity.

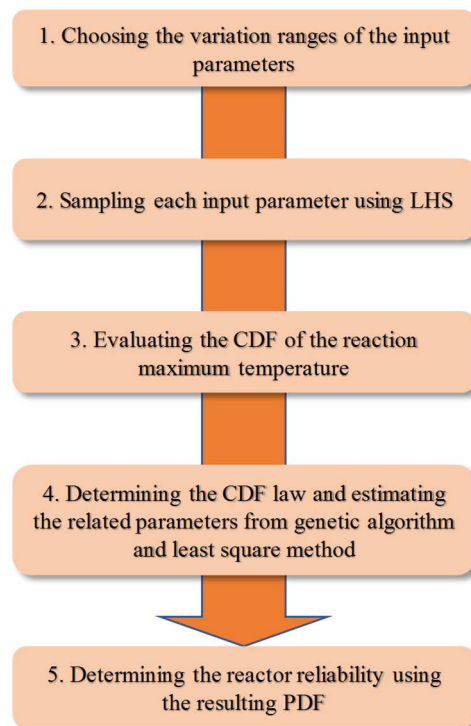

Figure 3. Flowchart of the method to obtain the reactor reliability

Step 1. The variation ranges of the input parameters have been set according to two constraints: the lower limits are adjusted to ensure the initiation of the chemical reaction, and the upper limits so that the boiling temperature of the reaction is not reached.

The variation of each parameter is defined within this variation range. When the three parameters vary, the fourth parameter is kept deterministic and fixed according to its nominal value. A new nominal value is considered for each simulation. All nominal values are given in Table 4.

Step 2. Random sampling of the input parameters using the basic Monte Carlo (MC) estimation requires a large number of simulations, resulting in high computational costs. However, the MC sampling can result in clusters of points in some intervals, while others receive no sample (Ali, et al., 2018). When dealing with uncertainties, sampling methods should ensure a good uniformity along the variation ranges of the input parameters. Latin

hypercube sampling (LHS) (Helton & Davis, 2003; Kewlani, et al., 2012) based on variance reduction techniques is a way of generating random samples. It aims at distributing the sampling points more uniformly over all possible values. One point is randomly selected in each interval to construct the samples by ensuring a high degree of uniformity in the distribution with a better convergence (Ali, et al., 2018; Caflisch, 1998).

For these reasons, a set of LH sample points of input parameters was generated with uniform distribution over the ranges given in Table 4. The sample size is 2×10^5 for each input parameter. In the first study, all input parameters have a randomly variation within their range defined in Table 4. In next study, one input parameter was fixed at a nominal value given in Table 4, while the other three input parameters have randomly variation by using the same ranges. The same simulation was repeated for several nominal values of the fixed parameter. This study has been reiterated for each input parameter.

Step 3. The uncertainties in the input parameters were implemented as input conditions to the chemical reactor model in Matlab®. The input parameters chosen as random variables followed a uniform distribution as explained in step 2. The uncertainties of these parameters have an impact on the reactor output represented by the reaction maximum temperature. Therefore, this distribution is propagated through the model to obtain resulting CDFs using Matlab®. The related CDF of maximum temperature was then plotted.

Step 4. The estimation of the law and the related parameters describing the CDFs were obtained through the genetic algorithm combined with the least squares method to minimize the following objective function:

$$\sum_i^n |F_i(model) - F_i(estimated)| \quad (13)$$

$F_i(estimated)$ is the estimated CDF, and $F_i(model)$ given by Eqs (1) to (12) is the empirical CDF obtained with $n = 2 \cdot 10^5$, n being the number of samples.

The two-sample Kolmogorov-Smirnov (Marsaglia et al., 2003) test given by `kstest2` in Matlab® was then applied to check the goodness of fit between the model of the maximum temperature and the estimated distributions of this temperature.

Step 5. The probability of non-failure or reliability was calculated using the PDF corresponding to the distribution law estimated in step 4. The results obtained from the reaction maximum temperature were processed according to the limit value defined at 80°C. This temperature corresponds to the decomposition of hydrogen peroxide under the reaction conditions studied (Dakkoune, et al., 2020).

4. Results and discussion

The maximum temperature of the reaction medium was adopted as a safety criterion. This threshold is used to assess the reactor reliability with respect to the random uncertainties of the input parameters. The input parameters variation ranges are given in Table 4.

	T_j (°C)	HP (mol/L)	FA (mol/L)	CuSO ₄ (mol/L)
Variation ranges	58 - 68	3 - 4	4 - 5	0 - 0.22
Nominal value (1)	58	3	4	0
Nominal value (2)	62	3.4	4.4	0.1
Nominal value (3)	66	3.8	4.8	0.2
Nominal value (4)	68	4	5	0.22

Table 4. The input parameters variation ranges and nominal values for the deterministic parameters

The variation of these input parameters affects the reaction medium temperature and therefore the reactor safety. Figure 4a shows the maximum temperature CDF obtained by the reactor model and the estimated one. Figure 4a is obtained from the random variation of the four input parameters. LHS method is applied to obtain uniformly distributed random samples of each such parameter. The resulting CDF is fitted by the generalized normal distribution expressed by Eq. (14). The figure also shows a good agreement between the estimated CDF and the one calculated by the model. In addition, Figure 4b shows the PDF calculated from the generalized normal PDF given by Eq (15).

$$F(T_r) = \frac{1}{2} + \text{sgn}(T_r - \mu) \frac{\gamma \left[\frac{1}{\beta} \left(\frac{|T_r - \mu|}{\alpha} \right)^\beta \right]}{2 \Gamma\left(\frac{1}{\beta}\right)} \quad (14)$$

$$p(T_r) = \frac{\beta}{2 \alpha \Gamma\left(\frac{1}{\beta}\right)} \exp \left[- \left(\frac{|T_r - \mu|}{\alpha} \right)^\beta \right] \quad (15)$$

T_r is the maximum reaction temperature, Γ is the Gamma function and γ is the incomplete Gamma function. The distribution parameters μ , β and α are determined using the genetic algorithm combined with the least square method. These parameters are reported in Table 5.

μ	β	α
79.65	3.58	8.63

Table 5. Parameters estimated of the generalized law

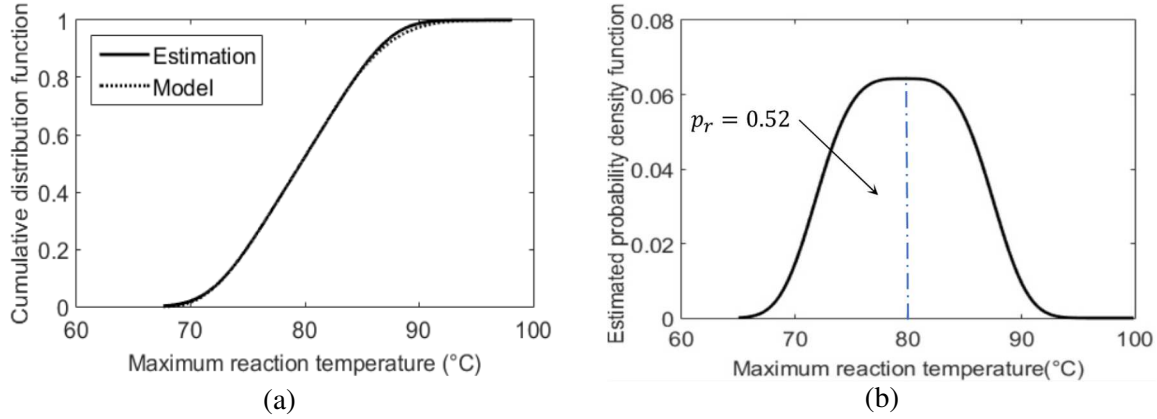

Figure 4. CDF (a) and PDF (b) of the maximum reaction temperature and the related probability of reliability p_r

The PDF is used to obtain the probability of reliability denoted p_r calculated from the area of the PDF for which the temperature is less than 80°C. Therefore, the reactor reliability for the operating conditions given in Table 5 is 0.52 as shown in Figure 4b.

4.1. Impact of the hydrogen peroxide concentration

To calculate the system reliability according to the hydrogen peroxide (HP) concentration, the distribution functions are obtained for different concentration values. Figure 5 shows a number of examples of CDFs obtained from both the model and the estimation. The model CDFs shown in Figure 5 are obtained for the four deterministic values of [HP] concentration given in Table 6. For each [HP] deterministic value, 2×10^5 new samples are generated for each input parameter (T_j , [FA] and [CuSO₄]). These samples vary within the ranges defined in Table 4. This sampling is performed using the LHS method.

The law governing these distribution functions is also the generalized normal distribution given by Eqs (14) and (15). The related parameters are reported in Table 6.

HP (mol/L)	3	3.4	3.8	4
μ	75.32	77.88	80.78	82.32
β	8.86	6.29	5.00	4.87

α	7.98	8.47	9.04	9.41
----------	------	------	------	------

Table 6. Estimated parameters of the generalized normal distribution

Figure 5 shows a good agreement between the results obtained from the model and those estimated. The resulting PDFs are depicted in Figure 6 to reach the probability of reliability p_r for each concentration.

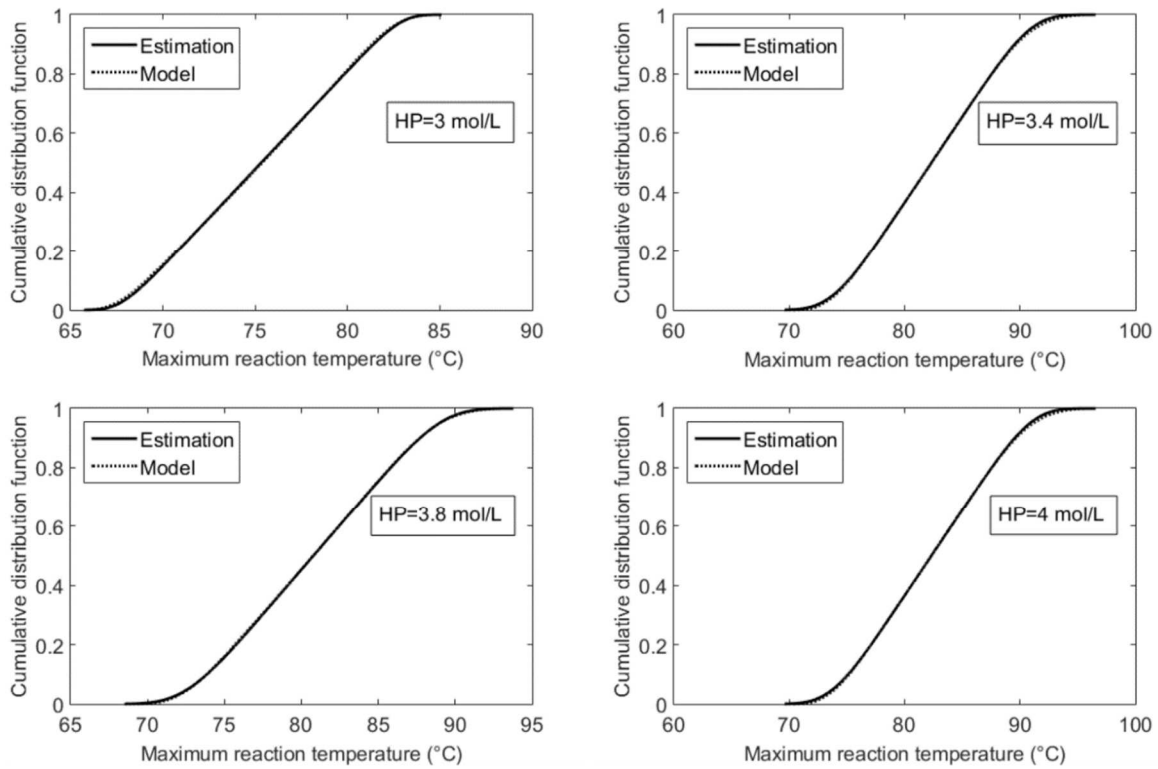

Figure 5. CDFs obtained for four hydrogen peroxide concentration values

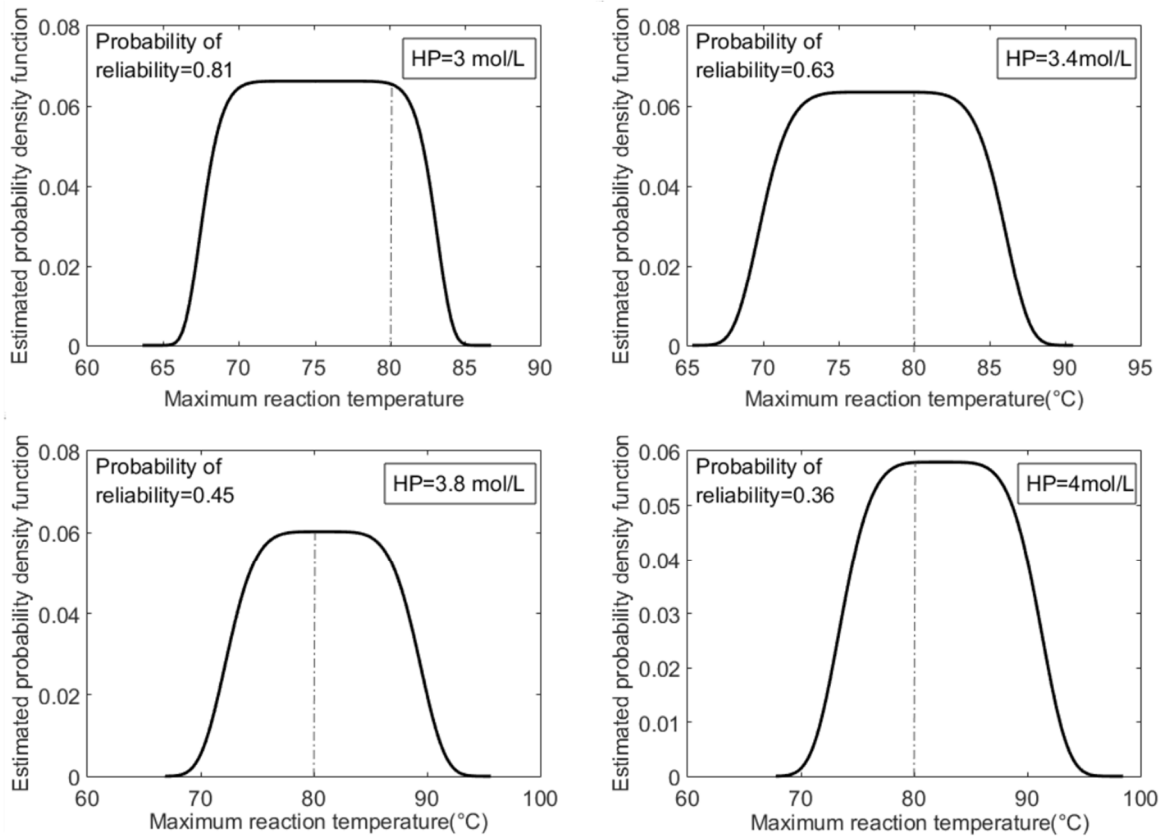

Figure 6. Resulting PDFs obtained for four hydrogen peroxide concentration values

Figure 7 shows a linear variation of the system reliability with the hydrogen peroxide concentration in the range studied. Indeed, increasing the concentration causes a non-negligible decrease in the system reliability. We can also note that the lowest concentration of 3 mol/L leads to a weak reliability (81%). Increasing the concentration by 1 mol/L reduces the reliability by almost half.

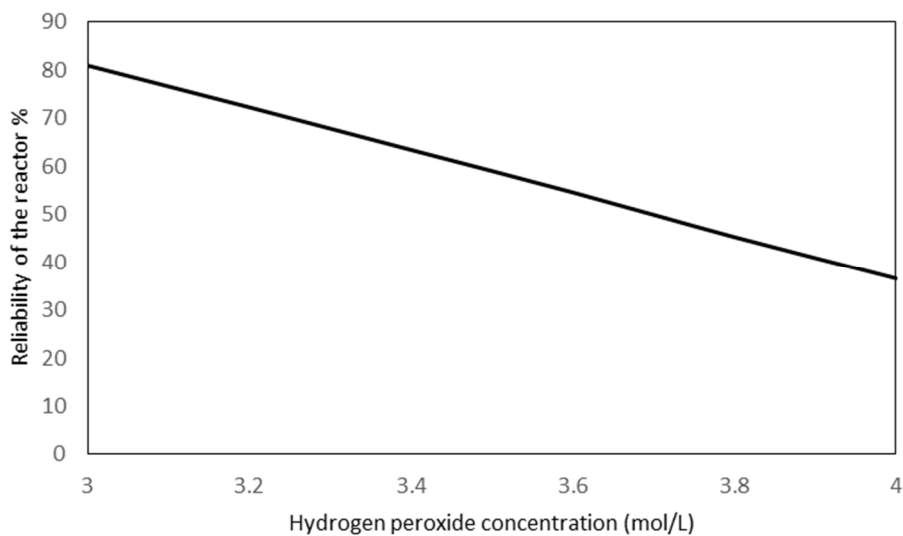

Figure 7. Reactor reliability versus the hydrogen peroxide concentration

4.2. Impact of the formic acid concentration

Similar to the previous section, the system reliability related to formic acid (FA) concentration was estimated. Distribution functions were obtained for different concentration values. The model CDFs shown in Figure 8 are obtained for the four deterministic values of [FA] concentration given in Table 7. For each [FA] deterministic value, 2×10^5 new samples are generated for each input parameter (T_j , [HP] and [CuSO₄]). These samples vary within the ranges defined in Table 4. This sampling is also performed using the LHS method. Figure 8 shows examples of CDFs obtained from the model and the estimation leading to the generalized normal distribution given by Eqs (14) and (15). The parameters are shown in Table 7. Figure 8 shows a good agreement between the results obtained from the model and the estimated function. The probability of reliability p_r for each concentration was deduced from the resulting PDFs presented in Figure 9.

FA (mol/L)	4	4.4	4.8	5
μ	76.73	78.22	79.68	80.4
β	4.22	4.03	3.68	3.53
α	8.71	8.78	8.82	8.86

Table 7. Estimated parameters of the generalized normal distribution for four concentrations

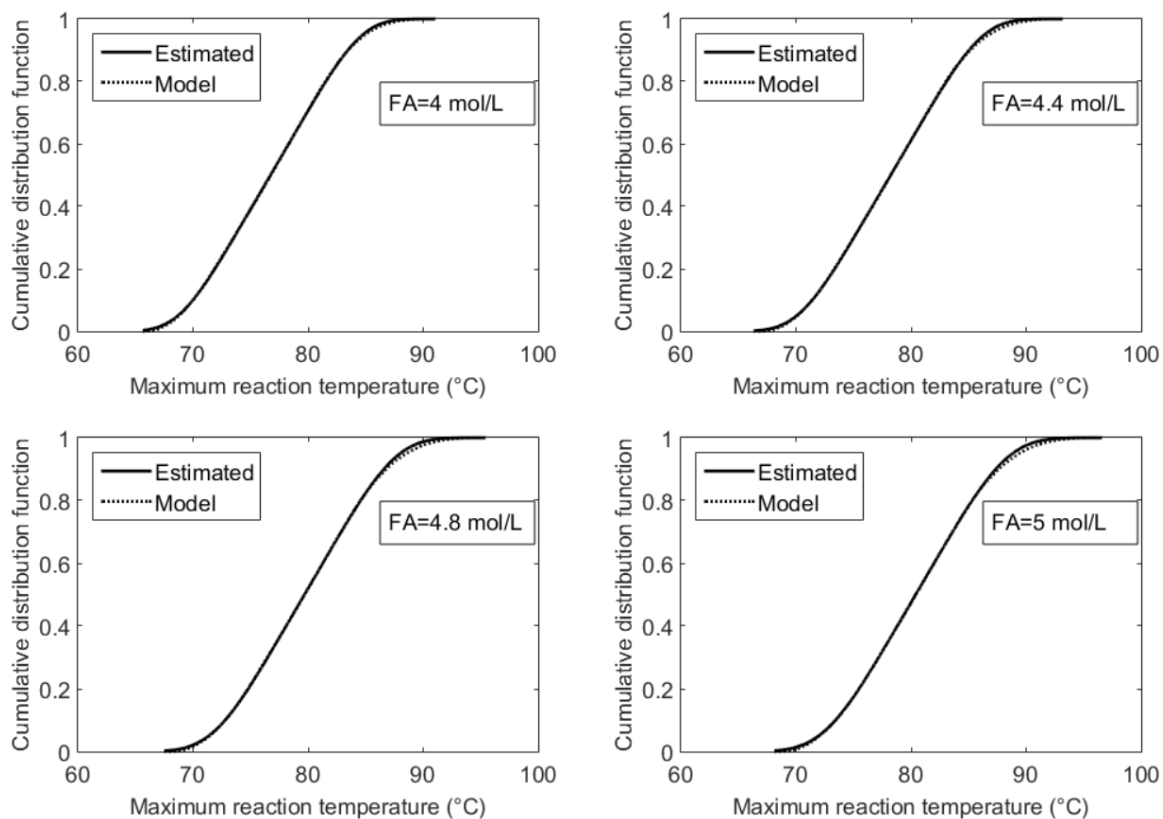

Figure 8. CDFs obtained for four formic acid concentration values

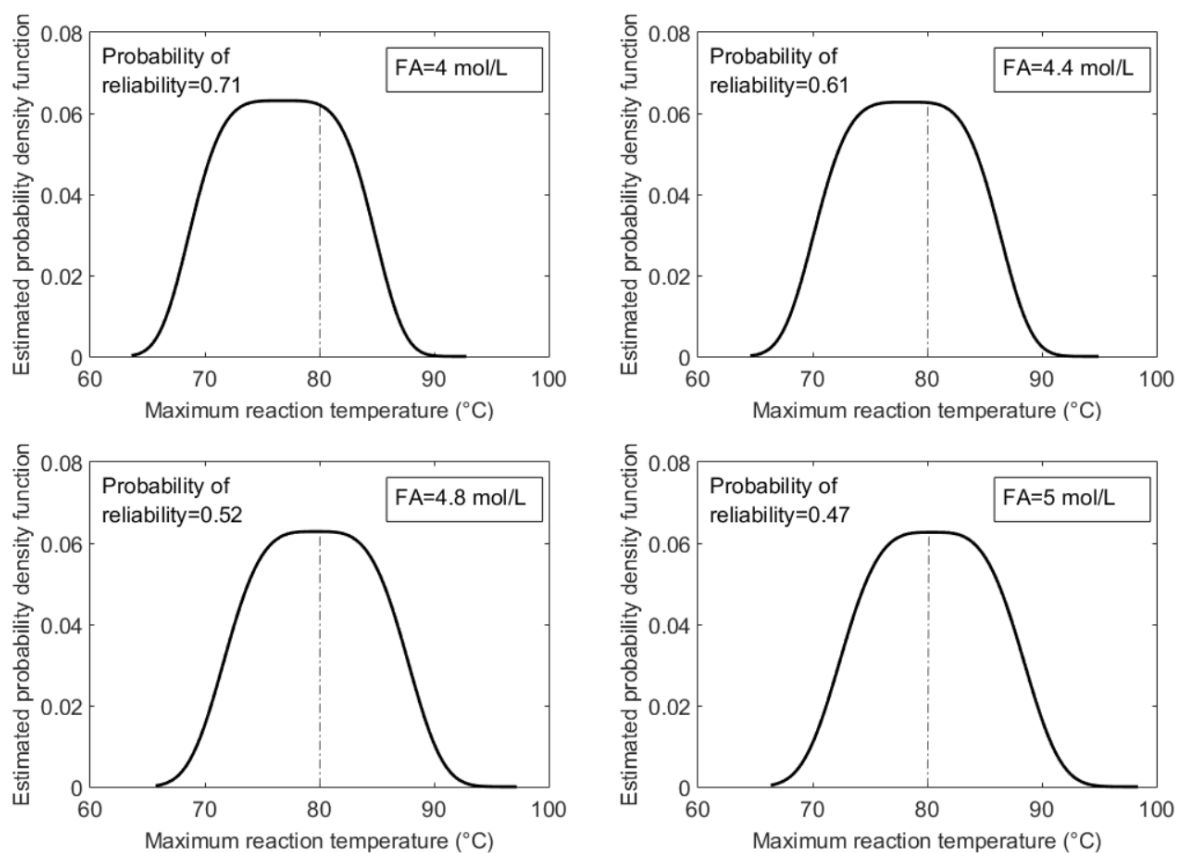

Figure 9. Resulting PDFs obtained for four formic acid concentration values

Figure 10 shows a linear variation of the system reliability with FA concentration. Similar to Figure 7, increasing the concentration causes a decrease in the system reliability. The lowest concentration of 4 mol/L leads to a reliability of 71%. It can be seen that increasing the formic acid concentration by 1 mol/L reduces the reliability, but not as much as increasing the hydrogen peroxide concentration in the previous case.

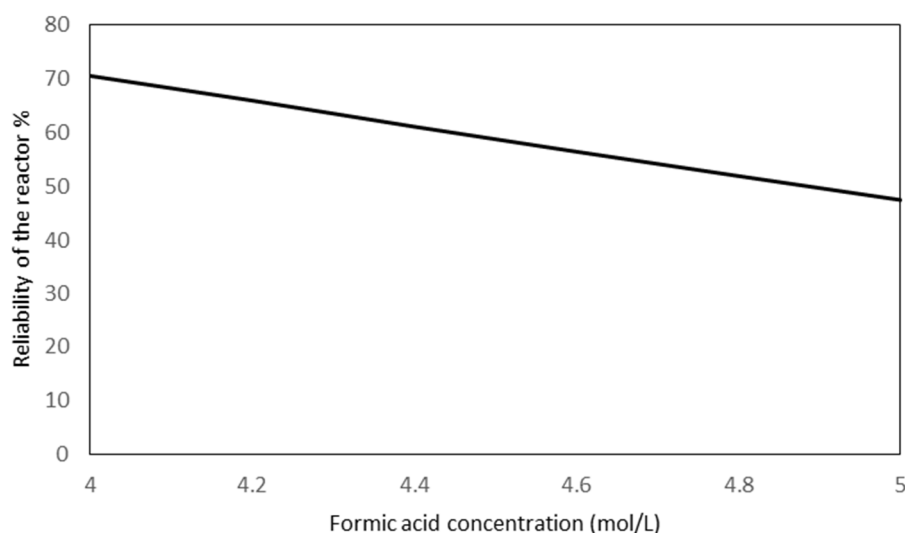

Figure 10. Reactor reliability versus the FA concentration

4.3. Impact of the CuSO_4 impurity concentration

Parameter assessment of the reaction maximum temperature distribution was carried out for different values of the copper sulphate concentration, impurity that affects the hydrogen peroxide decomposition. The model CDFs shown in Figure 11 are obtained for the four deterministic values of $[\text{CuSO}_4]$ concentration given in Table 8. For each $[\text{CuSO}_4]$ deterministic value, 2×10^5 new samples are generated for each input parameter (T_j , [HP] and [FA]). These samples vary within the ranges defined in Table 4. This sampling is also performed using the LHS method. Figure 11 shows some CFD examples resulting from the model and the estimation. The related parameters of the generalized normal distribution given by Eqs (14) and (15) are shown in Table 8. We can once again observe a good agreement between the results.

CuSO_4 (mol/L)	0	0.1	0.2	0.22
μ	76.68	78.60	79.47	79.61
β	3.93	3.41	3.54	3.71
α	8.05	8.84	9.25	9.32

Table 8. Estimated parameters of the generalized normal distribution for four concentrations

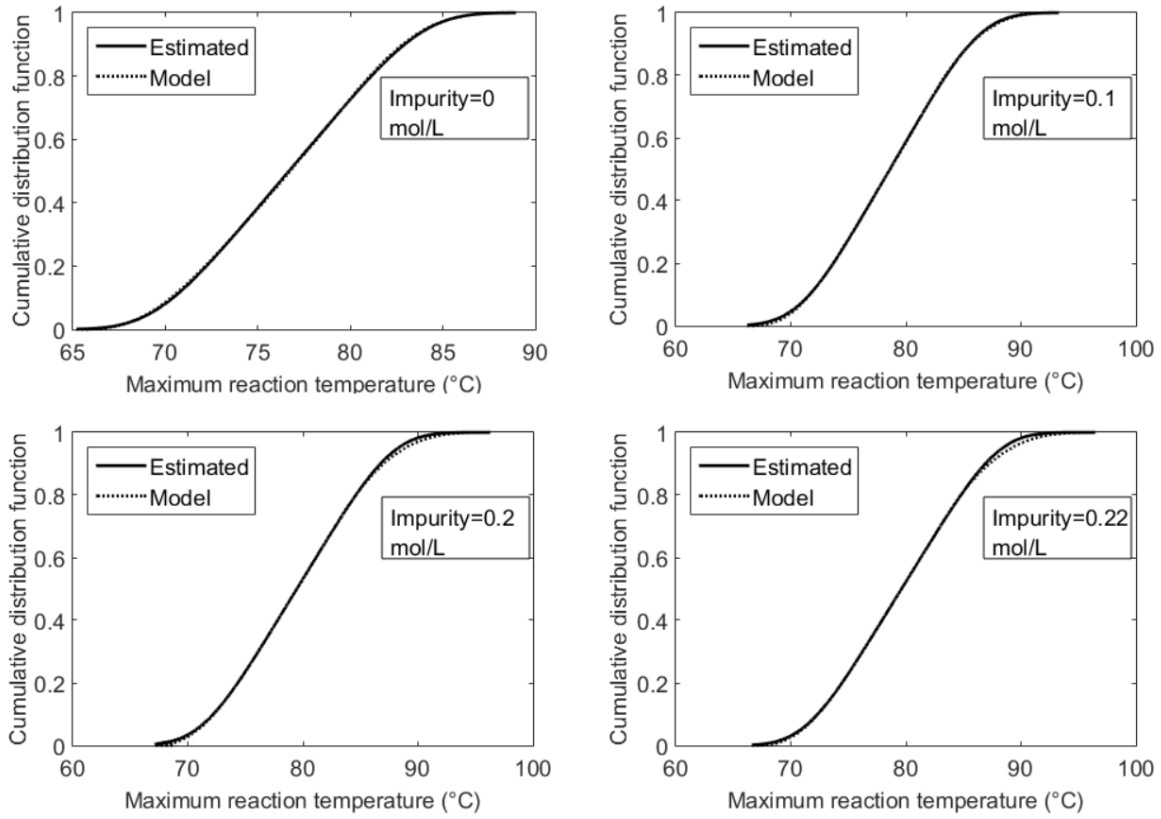

Figure 11. CDFs obtained for four CuSO_4 concentration values

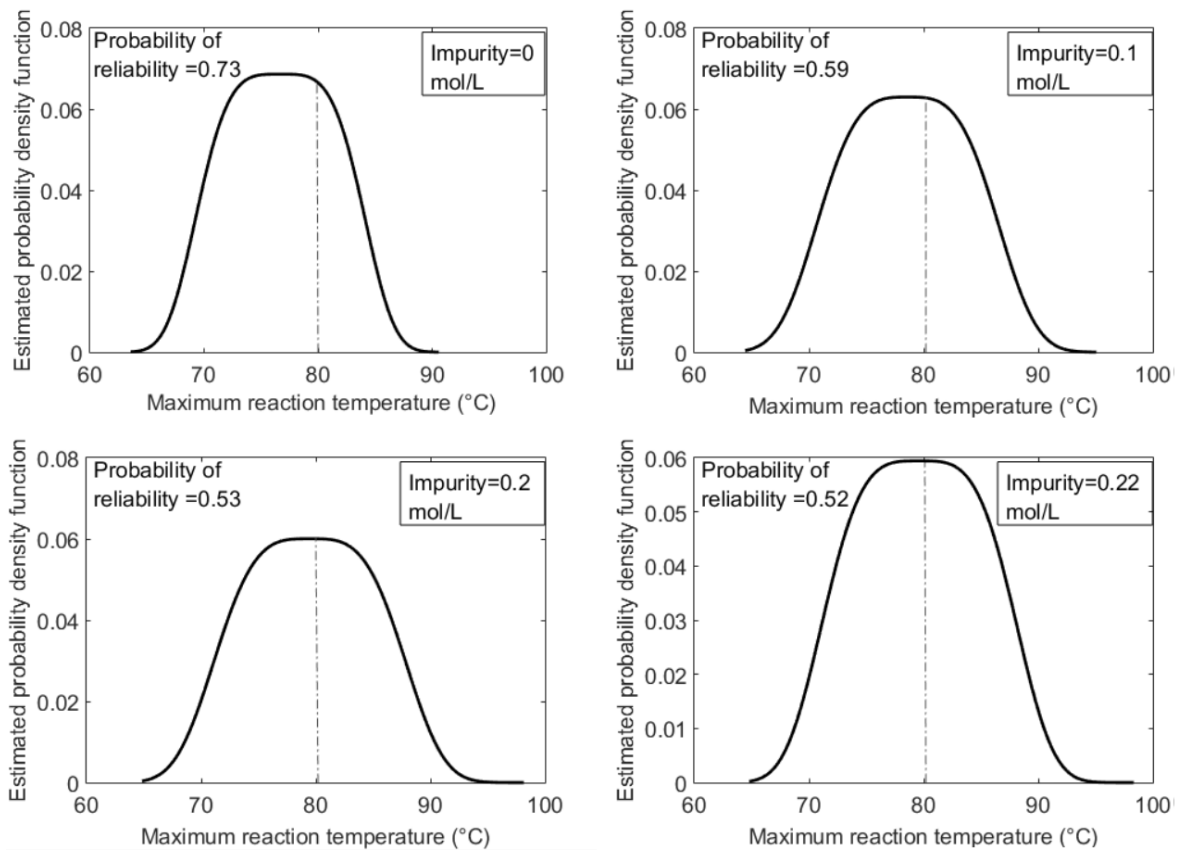

Figure 12. Resulting PDFs obtained for four CuSO_4 concentration values

Each value of the reliability probability was extracted for each copper sulphate concentration to plot the curve of Figure 13. A non-linear reliability decrease is observed with the concentration but this decrease is slower after 0.05 mol/L. The reliability of the system decreases from 73% without impurities to 52% with a concentration of 0.22 mol/L.

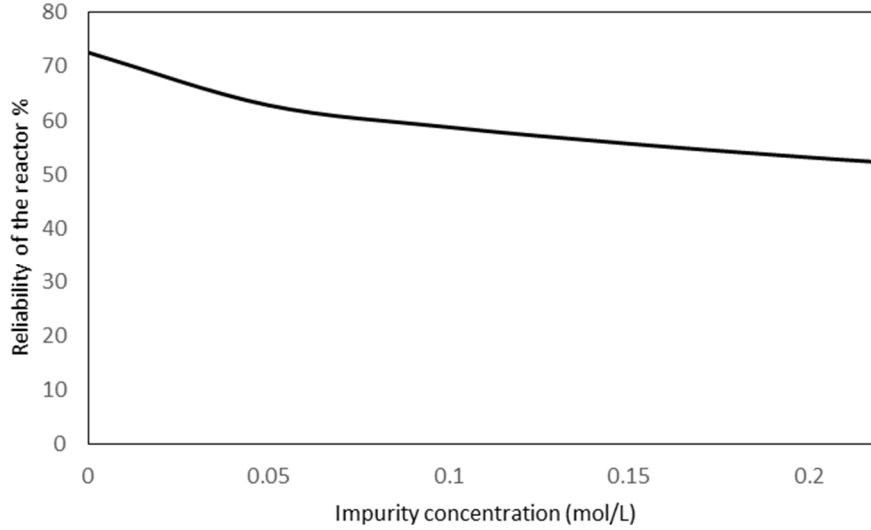

Figure 13. Reactor reliability versus the CuSO_4 concentration

4.4. Coolant temperature effect

Parameter assessment of the reaction maximum temperature distribution was carried out for different values of the coolant temperature T_j . The model CDFs shown in Figure 14 are obtained for the four deterministic values of T_j temperature given in Table 9. For each T_j deterministic value, 2×10^5 new samples are generated for each input parameter ([HP], [FA] and [CuSO₄]). These samples vary within the ranges defined in Table 4. The LHS method is also used here to provide the sampling. The estimation of CDF is given by the generalized extreme value (GEV) distribution. The related equations of the CDF and PDF are respectively given by:

$$F(T_r) = \exp \left[- \left(1 + \xi \left(\frac{T_r - \mu}{\sigma} \right) \right)^{-\frac{1}{\xi}} \right] \quad (16)$$

$$p(T_r) = \frac{1}{\sigma} \left(1 + \xi \left(\frac{T_r - \mu}{\sigma} \right) \right)^{-\frac{(\xi+1)}{\xi}} \exp \left[- \left(1 + \xi \left(\frac{T_r - \mu}{\sigma} \right) \right)^{-\frac{1}{\xi}} \right] \quad (17)$$

$\xi \in \mathbb{R}$, $\mu \in \mathbb{R}$ and $\sigma > 0$ represent respectively the shape, location and scale parameters of the distribution. The distribution examples presented in Figure 14 show a good agreement

between the model and the estimated function obtained with the parameters reported in Table 9.

T_j	58°C	62°C	66°C	68°C
μ	69.40	76.12	82.33	85.40
σ	2.095	2.35	2.64	2.85
ξ	-0.18	-0.19	-0.14	-0.12

Table 9. Estimated parameters for GEV distribution

To determine the system reliability according to the coolant temperature T_j , the PDFs obtained from Eq (17) are depicted in Figure 15.

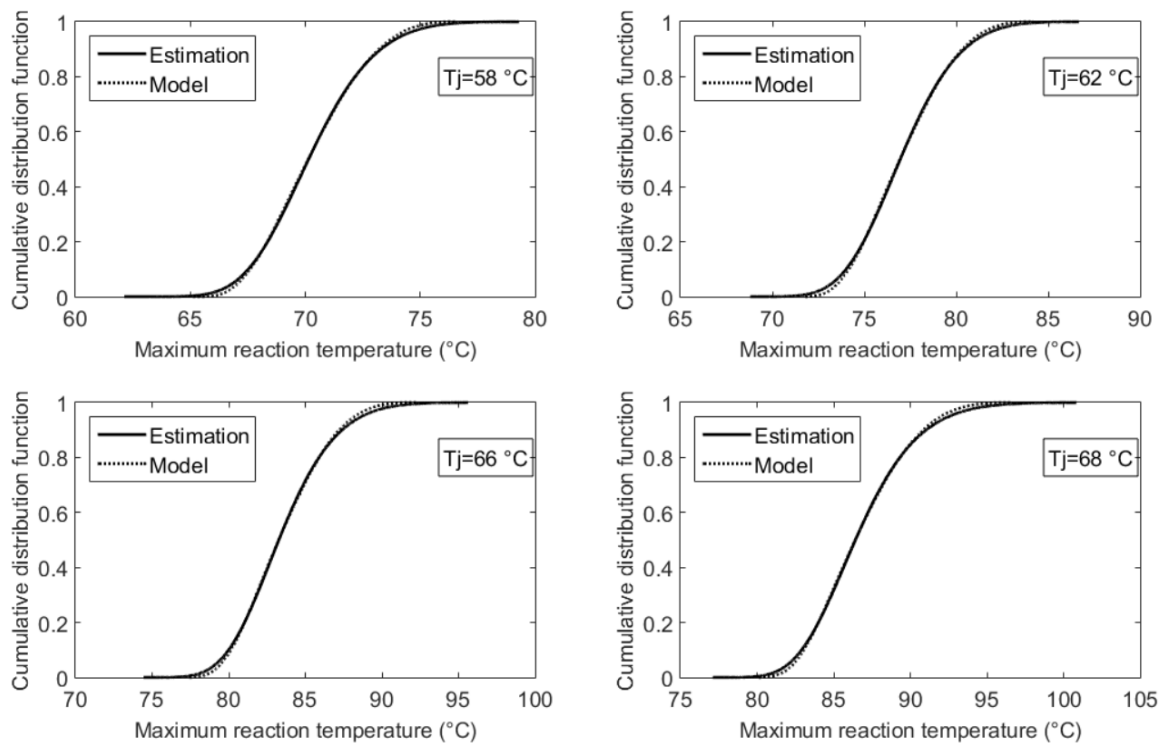

Figure 14. CDFs obtained for four coolant temperature values

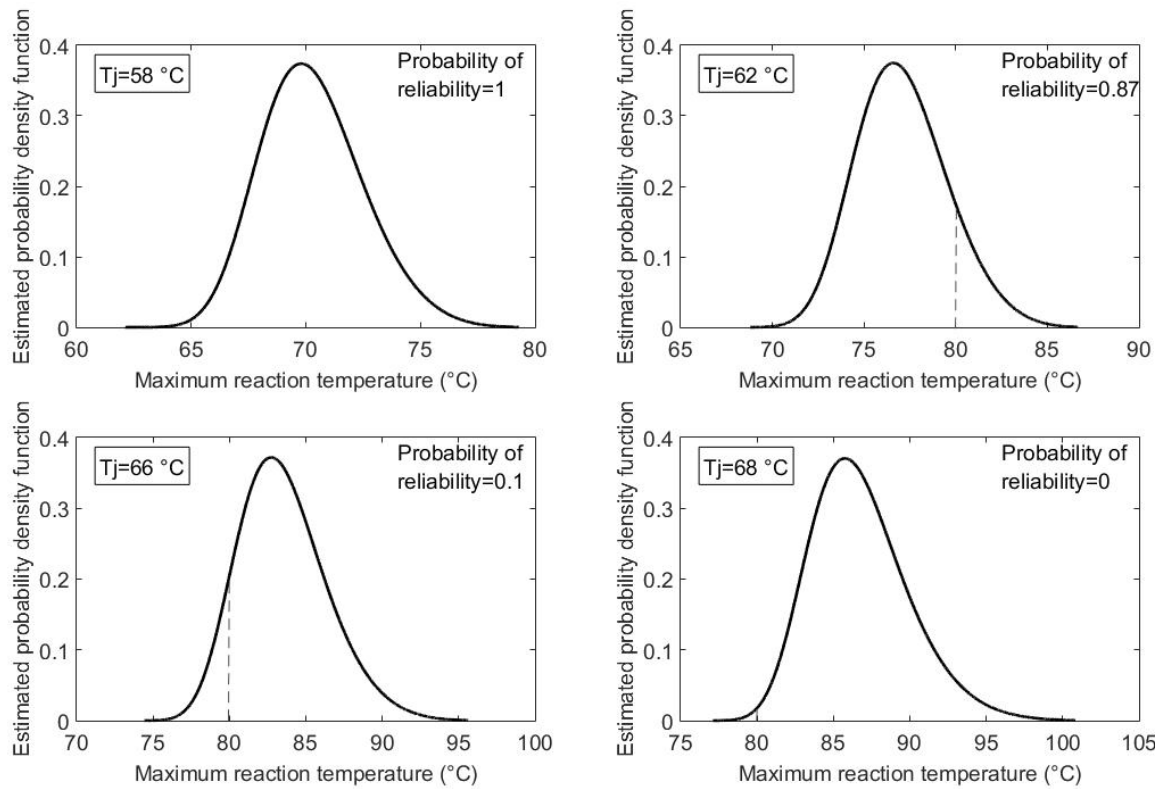

Figure 15. Resulting PDFs obtained for four coolant temperature values

Figure 16 shows the system reliability variation for each coolant temperature value. Reliability decreases as the coolant temperature increases. However, it can be seen that in this case the reliability is 100% for a temperature ranging from 58°C to 59°C. This result leads to conclude that the coolant temperature is the only parameter that provides 100% reliability when the temperature conditions are maintained within a range of 58°C to 59°C.

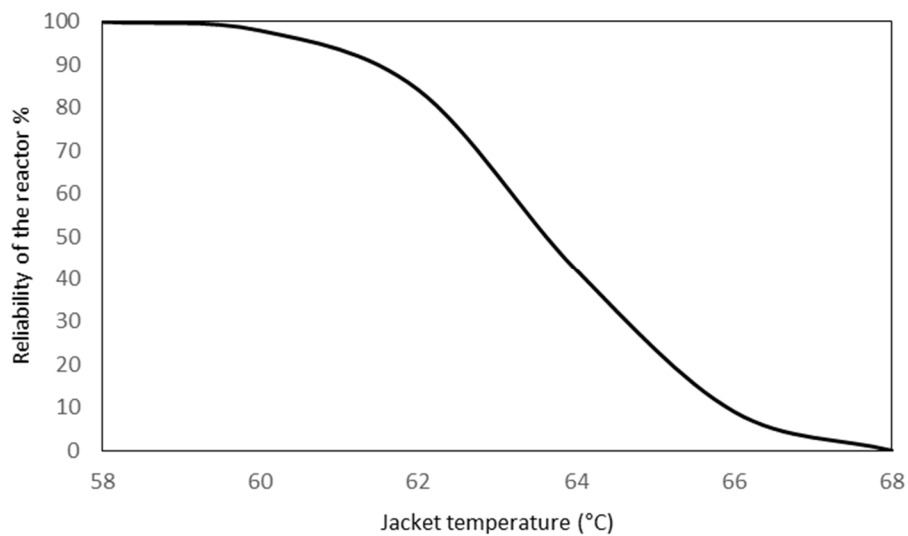

Figure 16. Reactor reliability versus the jacket temperature

5. Conclusion

In this work, the reliability of an isoperibol chemical reactor with a peroxyformic acid synthesis reaction was studied. The input parameters of this reaction have a random variation uniformly distributed over well-defined intervals.

The reaction maximum temperature distributions were estimated by considering a set of random input parameters. The PDF is used to obtain the probability of reliability calculated from the area of the PDF for which the temperature is less than 80°C. This limit was set at 80°C in order to avoid hydrogen peroxide decomposition reactions.

This study leads to conclude, considering the random variations of the other inputs, that the coolant temperature is the only input parameter that can maintain the reactor in a safe operating area with 100% reliability.

It should be pointed out, that the purpose of this approach is to propose a method for determining the effects of input parameters random variations on a safety criterion (here the maximum reaction temperature). Such study can be conducted in advance to determine the parameters variation ranges ensuring the system reliability despite the random variations of the inputs.

Acknowledgments

This study was conducted within the framework of the project AMED (Multidisciplinary Analysis of Domino Effects), which has been funded with the support from the European Union with the European Regional Development Fund (ERDF) and from the Regional Council of Normandie.

6. References

Abubakar, U., Sriramula, S., & Renton, N. (2015). Reliability of complex chemical engineering processes. *Computers and Chemical Engineering*, 74, 1–14.

Ali, W., Duong, P., Khan, M., Getu, M., & Lee, M. (2018). Measuring the reliability of a natural gas refrigeration plant: Uncertainty propagation and quantification with polynomial chaos expansion based sensitivity analysis. *Reliability Engineering & System Safety*, 172, 103-117.

Balasubramanian, S., & Louvar, J. (2004). Study of major accidents and lessons learned. *Process Safety Progress*, 21(3), 237–244.

Caflisch, R. (1998). Monte Carlo and quasi-Monte Carlo methods. *Acta Numerica*, 7, 1-49.

Casson, V., Lister, D., Milazzo, M., & Maschio, G. (2012). Comparison of criteria for prediction of runaway reactions in the sulphuric acid catalyzed esterification of acetic anhydride and methanol. *Journal of Loss Prevention in the Process Industries*, 25, 209-217.

Dakkoune, A., Vernières Hassimi, L., Lefebvre, D., & Estel, L. (2020). Early detection and diagnosis of thermal runaway reactions using model-based approaches in batch reactors. *Computers & Chemical Engineering*, 140, 1-16.

Dakkoune, A., Vernières-Hassimi, L., Leveneur, S., Lefebvre, D., & Estel, L. (2018). Risk analysis of French chemical industry. *Safety Science*, 105, 77–85.

Dakkoune, A., Vernières-Hassimi, L., Leveneur, S., Lefebvre, D., & Estel, L. (2019). Analysis of thermal runaway events in French chemical industry. *Journal of Loss Prevention in the Process Industries*, 62, 1-9.

Duong, P., Ali, W., Kwok, E., & Lee, M. (2016). Uncertainty quantification and global sensitivity analysis of complex chemical process using a generalized polynomial chaos approach. *Computers & Chemical Engineering*, 90, 23-30.

Helton, J., & Davis, F. (2003). Latin hypercube sampling and the propagation of uncertainty in analyses of complex systems. *Reliability Engineering & System Safety*, 81, 23-69.

Kewlani, G., Crawford, J., & Lagnemma, K. (2012). A polynomial chaos approach to the analysis of vehicle dynamics under uncertainty. *Vehicule System Dynamics*, 749-774.

Marsaglia, G., W. Tsang, and J. Wang. (2003). Evaluating Kolmogorov's Distribution. *Journal of Statistical Software*. Vol. 8, Issue 18, 1-4. DOI: <https://doi.org/10.18637/jss.v008.i18>

Marzzacco, C. (1999). The Enthalpy of Decomposition of Hydrogen Peroxide: A General Chemistry Calorimetry Experiment. *Journal of Chemical Education*, 76(11), 1517.

Perez-Benito, J. (2001). Copper(II)-Catalyzed Decomposition of Hydrogen Peroxide: Catalyst Activation by Halide Ions. *Monatshefte für Chemie*, 132, 1477-1492.

Stoessel, F. (2008). *Thermal Safety of Chemical Processes: Risk Assessment and Process Design*. Germany: John Wiley & Sons.

Stoessel, F. (2009). Planning protection measures against runaway reactions using criticality classes. *Process Safety and Environmental Protection*, 87(2), 105-112.

Tatsuoka, T., & Koga, N. (2013). Energy Diagram for the Catalytic Decomposition of Hydrogen Peroxide. *J. Chem. Educ.*, 90, 633–636.

Thomas, P. H., & Bowes, P. (1961). Some aspects of the self-heating and ignition of solid and cellulosic materials. *British Journal of Applied Physics*, 12(222).

Vernières-Hassimi, L., & Leveneur, S. (2015). Alternative method to prevent thermal runaway in case of error on operating conditions continuous reactor. *Process Safety and Environmental Protection*, 98, 365–373.

Vernieres-Hassimi, L., Assoudi-Baikari, R., Abdelghani-Idrissi, M., & Mouhab, N. (2016). New Analytical Method for Maximum Temperature Assessment in an Exothermic Tubular Chemical Reactor. *Chemical Engineering Communications*, 203, 174–181.

Vernières-Hassimi, L., Dakkoune, A., Abdelouahed, L., Estel, L., & Leveneur, S. (2017). Zero-Order Versus Intrinsic Kinetics for the Determination of the time to Maximum Rate under Adiabatic Conditions (TMRad): Application to the Decomposition of Hydrogen Peroxide. *Industrial & Engineering Chemistry Research*, 56(45), 13040-49.

Zhang, Y., Chung, Y.-H., Liu, S.-H., Shu, C.-M., & Jiang, J.-C. (2017). Analysis of thermal hazards of O,O-dimethylphosphoramidothioate by DSC, TG, VSP2 and GC/MS. *Thermochimica Acta*, 652, 69-76.

Zheng, J., Wärnå, J., Salmi, T., Burel, F., Taouk, B., & Leveneur, S. (2016). Kinetic modeling strategy for an exothermic multiphase reactor system: Application to vegetable oils epoxidation using Prileschajew method. *AIChE Journal*, 62, 726-741.