



HAL
open science

Maximum likelihood sequence estimation based on periodic time-varying trellis for LPTVMA systems

Bogdan Cristea, Daniel Roviras, Benoît Escrig

► **To cite this version:**

Bogdan Cristea, Daniel Roviras, Benoît Escrig. Maximum likelihood sequence estimation based on periodic time-varying trellis for LPTVMA systems. 14th European Signal Processing Conference (EUSIPCO 2006), Sep 2006, Florence, Italy. pp.1-5. hal-04090324

HAL Id: hal-04090324

<https://hal.science/hal-04090324>

Submitted on 5 May 2023

HAL is a multi-disciplinary open access archive for the deposit and dissemination of scientific research documents, whether they are published or not. The documents may come from teaching and research institutions in France or abroad, or from public or private research centers.

L'archive ouverte pluridisciplinaire **HAL**, est destinée au dépôt et à la diffusion de documents scientifiques de niveau recherche, publiés ou non, émanant des établissements d'enseignement et de recherche français ou étrangers, des laboratoires publics ou privés.

MAXIMUM LIKELIHOOD SEQUENCE ESTIMATION BASED ON PERIODIC TIME-VARYING TRELLIS FOR LPTVMA SYSTEMS

Bogdan Cristea, Daniel Roviras, and Benoît Escrig

IRIT, INPT/ENSEEIH
2 rue Charles Camichel, 31071, Toulouse, France
phone: + 33 (0)5 61 58 80 10, fax: + 33 (0)5 61 58 83 06, email: cristea@enseeiht.fr
web: www.irit.fr

ABSTRACT

In this paper we show how Maximum Likelihood Sequence Estimation (MLSE) can be implemented in a Linear Periodic Time-Varying Multiple Access (LPTVMA) system. Assuming quasi-synchronous users, LPTVMA systems can be considered as Multi User Interference (MUI) free systems. Hence LPTVMA systems can be equalized. In multipath channels the equalization step uses a Zero Padding (ZP) technique. The equivalent channel to equalize is a zero-pad channel. For such zero-pad channels the MLSE can be efficiently implemented by using a parallel trellis Viterbi algorithm. The complexity of the MLSE can be further reduced because the padding zeros have known positions in the received signal. The proposed MLSE uses a periodic time-varying trellis. Thus the number of states of the MLSE can be reduced. The performances of LPTVMA systems using the proposed MLSE are evaluated by simulations.

1. INTRODUCTION

LPTVMA is a recently proposed multiple access technique based on orthogonal LPTV filters [1]. The LPTVMA systems belong to the same class as Chip-Interleaved Block-Spread Code Division Multiple Access (CIBS-CDMA) systems, already studied in the literature [2]. The LPTV filters [3] are realized by the serial concatenation of a modulator with a matrix interleaver. The input signal of the LPTV filter is some band limited signal. User orthogonality is obtained as in Frequency Division Multiple Access (FDMA) systems by modulating the input signals with carrier frequencies multiples of the spectral support of the input signals. The matrix interleaver is the same for all users and is used to permute the samples of the modulated signal. Hence a spread spectrum multiple access system is obtained. With the spreading operation, frequency diversity is obtained in our LPTVMA system.

In [4] a synchronization technique was developed for such spread spectrum systems. By using a ZP technique, in [5] it has been shown how the effect of multipath channels can be mitigated. It has been also shown that, when the users are quasi-synchronous, LPTVMA systems are MUI-free. Thus only equalization techniques need to be employed at the reception. The equivalent channel to equalize is a zero-pad channel [6] with a high proportion of zero valued taps in the equivalent channel impulse response. The presence of zero valued taps in the equivalent channel impulse response is a consequence of the use of the ZP technique and matrix interleavers. These zero-pad channels suggest the use of MLSE based on parallel trellis Viterbi algorithm [6].

In our LPTVMA system, the ZP technique periodically introduces zeros into the emitted signal. Thus the use of MLSE is complicated since the constellation size of the emitted signal increases. For example, when the input signal is a BPSK signal, the use of the ZP technique adds the zero symbol to the existing constellation so that the resulting ZP signal belongs to a constellation with three symbols $\{-1, 0, +1\}$. The contribution of this paper is to show how to adapt the MLSE for such ZP signals. In our approach the knowledge of the padding zeros position will be used to reduce the number of states of the channel trellis. Thus the complexity of the MLSE can be reduced.

The rest of the paper is organized as follows. In section 2 LPTVMA systems are described. Main system properties are also pointed out. Section 3 presents the ZP input signal construction. It is shown then that the proposed system is MUI-free. The adaptation of the MLSE to such ZP signals is presented. It is shown how the MLSE can be adapted for such ZP signals. Numerical simulations are presented in section 4. Section 5 gives some concluding remarks.

2. LPTVMA SYSTEM MODEL

The proposed multiple access system is depicted in Fig. 1.

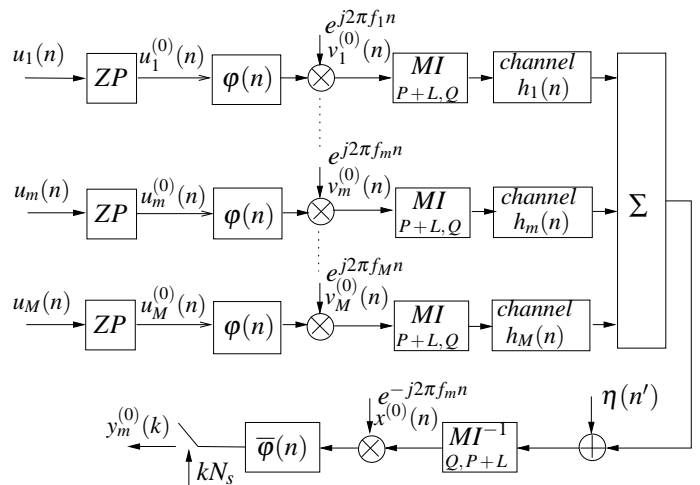

Figure 1: LPTVMA system model

The input signal for the m -th user $u_m(n)$ is an upsampled signal with the upsampling factor N_s . The upsampled signal is then processed by a ZP block that adds zeros periodically. More details on the ZP technique [2] will be given in the next section. The ZP signal, $u_m^{(0)}(n)$, is shaped by a band limited

filter with impulse response $\varphi(n)$. The superscript (0) denotes a ZP signal. The pulse shaped signal is modulated using a carrier frequency f_m . User orthogonality is achieved as in FDMA systems by choosing carrier frequencies multiples of the spectral support of the input signal.

The samples of the modulated signal are then permuted by a matrix interleaver [7] with $P+L$ lines and Q columns, where P , Q are integer numbers and L is the time-discrete channel order. The use of matrix interleaver with these parameters is a consequence of the ZP technique. The matrix interleaver period is $N = (P+L)Q$. The matrix interleaver is the same for all users and is used to spread the input signal. The samples of the input signal are written into the matrix interleaver row-wise and read column-wise. The spreading operation realized with the matrix interleaver allows for frequency diversity in the proposed multiple access system. Thus, instead of having flat fading channels with low attenuations for some users, all users see frequency selective channels.

In order to have a spread spectrum signal at the matrix interleaver output, the permuted samples must be as uncorrelated as possible. Hence the number of columns of the matrix interleaver, Q , must be chosen large enough. When the shaping filter is a Finite Impulse Response (FIR) filter, the number Q must be chosen higher or equal to the number of coefficients of the shaping filter. Thus, two adjacent samples at the matrix interleaver output are spaced out at the FIR shaping filter length.

For example, using a BPSK modulated input signal with $N_s = 16$ samples per symbol, a Squared Raised Cosine (SRC) shaping filter (rolloff factor $\alpha = 0.5$), and with a matrix interleaver with $P+L = 27$ lines and $Q = 80$ columns, the spreaded signal for one user is represented in Fig. 2.

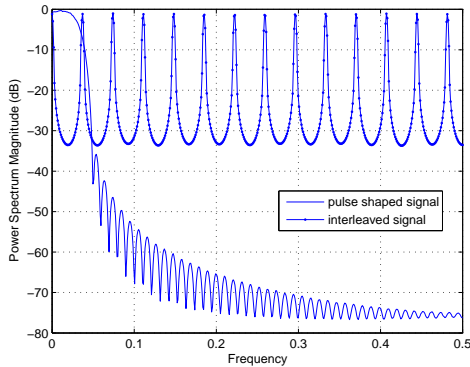

Figure 2: The pulse shaped signal before and after interleaving

The interleaved signal is then passed through a time discrete channel, different for each user, with impulse response:

$$h_m(n) = \sum_{i=0}^L h_i^{(m)} \delta(n-i) \quad (1)$$

where m is the user number, $\{h_i^{(m)}\}_{i \in \{0,1,\dots,L\}}$ are the channel coefficients and $\delta(n)$ is the Kronecker function. Without loss of generality we consider that all users share the same

channel order L . This assumption is possible in a quasi-synchronous multiple access system, when user delays are sufficiently small to be absorbed in a common channel order L .

The received signal is deinterleaved by a matrix interleaver with Q lines and $P+L$ columns. After deinterleaving the received signal can be written as [5]:

$$x^{(0)}(n) = \sum_{m=1}^M \sum_{i=0}^L h_i^{(m)} v_m^{(0)}(n - f_i(n)) + \eta(n) \quad (2)$$

where $\eta(n)$ is an interleaved version of $\eta(n')$, the white gaussian noise at the receiver input, and $f_i(n)$ are N -periodic functions, related to matrix interleaver and deinterleaver, and having the following expression:

$$f_i(n) = \underline{n}_N - \pi^{-1}(\underline{n}_N) + i + \pi^{-1}(\underline{n}_N) - i - \pi(\pi^{-1}(\underline{n}_N) - i) \quad (3)$$

where \underline{n}_N is the remainder of the Euclidean division of n by N ,

$$\pi(\underline{n}_N) = Q\underline{n}_{P+L} + \frac{\underline{n}_N - \underline{n}_{P+L}}{P+L} \quad (4)$$

and

$$\pi^{-1}(\underline{n}_N) = (P+L)\underline{n}_Q + \frac{\underline{n}_N - \underline{n}_Q}{Q} \quad (5)$$

are the permutations that characterize the matrix interleaver and its inverse, respectively.

After deinterleaving the signal is demodulated and filtered with a matched filter of impulse response $\bar{\varphi}(n)$. The output of the matched filter is then sampled with the sampling factor N_s .

When a SRC filter is used as a shaping filter, it can be shown that the maximum number of users that can be accommodated is:

$$M_{\max} = \left\lfloor \frac{N_s}{1+\alpha} \right\rfloor \quad (6)$$

where $\lfloor \cdot \rfloor$ is the floor operator.

So the maximal number of users depends on the number of samples per symbol N_s and the rolloff factor α . For example, using a number of samples per symbol $N_s = 16$ and with a rolloff factor $\alpha = 0.5$, the maximal number of users is $M_{\max} = 10$.

Following (2) it can be seen that each emitted signal $v_m^{(0)}(n)$ is affected by a periodic time varying delay $f_i(n)$ (3). The equivalent system with inputs $v_m^{(0)}(n)$ and output $x^{(0)}(n)$ could be seen as an LPTV filter [3]. Due to its time varying nature the recovery of the emitted signals is difficult. In order to cope the time-varying characteristic of the overall transmission chain a ZP technique is used. This issue will be addressed in the next section.

3. THE ZP SIGNAL CONSTRUCTION AND THE PERIODIC TIME-VARYING TRELLIS

In this section the ZP technique used to cancel the time-varying nature of the equivalent LPTV filter (2) is described. Further, using the structure of the ZP signal, the MLSE will be adapted for ZP signals.

In the ZP block the upsampled signal, $u_m(n)$, is partitioned into N -sample frames. Each frame has $L_{sh} + LQ$ zero

samples after the last nonzero symbol (Fig. 3), where L_{sh} is the order of the FIR shaping filter. The first L_{sh} zero samples will empty the shaping filter memory so that at the output of the shaping filter the signal has LQ zeros at the end of each N -sample frame. When each frame is permuted by the matrix interleaver, the last L lines of the matrix interleaver are always filled with zeros. This is a mandatory condition in order to cancel the time-varying nature of the equivalent LPTV filter (2) in L -order multipath channels [5].

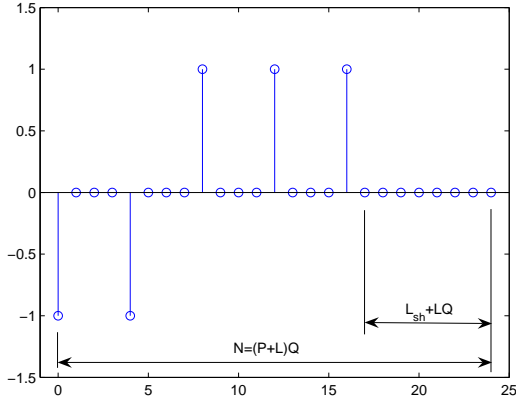

Figure 3: The LPTVMA frame at the input of the shaping filter

Using the fact that the emitted signals, $v_m^{(0)}(n)$, are ZP signals, expression (2) becomes [5]:

$$x^{(0)}(n) = \sum_{m=1}^M \sum_{i=0}^L h_i^{(m)} v_m^{(0)}(n - iQ) + \eta(n) \quad (7)$$

So, the equivalent LPTV system (2) becomes a Linear Time Invariant (LTI) system (7).

Further, since the users are separated in the frequency domain, the proposed multiple access system has no MUI. The system remains MUI-free while the users are quasi-synchronous and can share the same channel order L .

So, after the matched filter, the received sampled signal, $y_m^{(0)}(k)$, can be written as:

$$\begin{aligned} y_m^{(0)}(k) &= \bar{\varphi}(k) * \left(e^{-j2\pi f_m k} x^{(0)}(k) \right) = \\ &= \sum_{i=0}^L h_i^{(m)} e^{-j2\pi f_m i Q} u_m^{(0)}(k - iQ) + \\ &+ \bar{\varphi}(k) * \left(e^{-j2\pi f_m k} \eta(k) \right) \end{aligned} \quad (8)$$

For mathematical convenience, the number of columns of the matrix interleaver Q is chosen equal to an integer multiple of the sampling factor N_s : $Q = qN_s$. The number of columns of the interleaver Q is chosen large enough to spread the emitted signal so that $q > 1$.

Since there is no MUI and the channel to equalize is an LTI system (8), classical equalization techniques (decision feedback equalizers, MLSE) [8] can be used.

Following (8) it should be noted that two delayed versions of the same emitted signal, $u_m^{(0)}(k)$, are spaced out

a multiple of q samples apart. Such channels are referred as zero-pad channels [6], since, in the channel impulse response, there are $q - 1$ zero-valued taps between two adjacent non-zero valued taps. For such zero-pad channels MLSE can be efficiently applied by using a parallel trellis Viterbi algorithm [6] (Fig. 4).

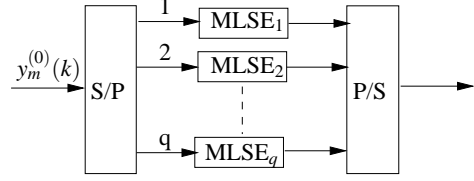

Figure 4: The parallel trellis Viterbi algorithm represented as a structure of parallel MLSE for zero-pad channel equalization

The signal at the equalizer input $y_m^{(0)}(k)$ is serial to parallel converted into q streams. Since the samples in each parallel stream are spaced out q samples apart with respect to the original stream, the equivalent channel to be equalized by the MLSE has the impulse response given in (1). Thus the MLSE in each branch can work in parallel on the same trellis with a number of states greatly reduced. For example, if the equalizer ZP input signal belongs to a three symbols constellation $\{-1, 0, +1\}$, then the number of states of the trellis used in each branch is 3^L (1), instead of 3^{Lq} states (8). Further, since the samples on each branch are received q times slower than the original stream, the computational complexity of the MLSE using a parallel trellis Viterbi algorithm is almost the same as a classical MLSE using a trellis for the channel with impulse response (1).

Note that the equalizer input, $y_m^{(0)}(k)$, is a ZP signal, where the zeros positions are known. Our idea is to use this knowledge in order to further reduce the number of trellis states.

In order to have the same trellis on all branches with 2^L states instead of 3^L states, the ZP signal is constructed so that, after the serial to parallel conversion, the signal has the same frame structure in all branches (Fig. 5).

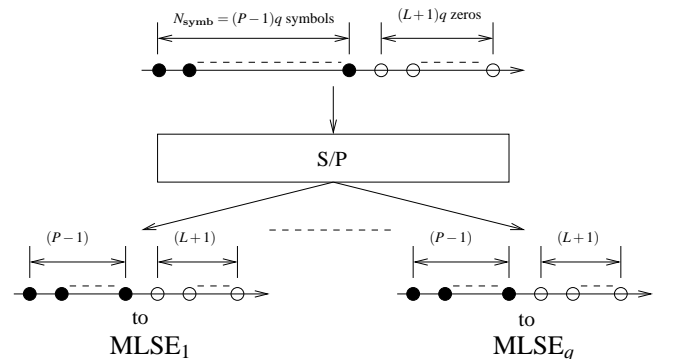

Figure 5: The ZP signal frame structure before and after serial to parallel conversion

Thus, the number of nonzero symbols in each LPTVMA

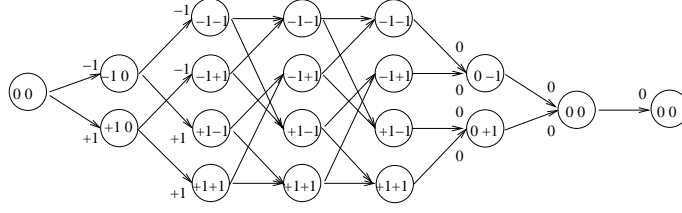

Figure 6: Periodic time-varying trellis (one period) for a channel of order $L = 2$ and for BPSK modulated input symbols

frame, N_{symb} , is chosen so that:

$$N_{\text{symb}} = Pq + 1 - \frac{L_{\text{sh}} + 1}{N_s} \quad (9)$$

Further, the order of shaping filter is chosen so that the following condition is satisfied:

$$1 - \frac{L_{\text{sh}} + 1}{N_s} = -kq \quad (10)$$

where $k > 0$ is an arbitrary chosen integer number.

The number of nonzero symbols in each LPTVMA frame, N_{symb} , is maximized when $k = 1$. So, when $k = 1$, the order of the shaping filter is:

$$L_{\text{sh}} = (1 + q)N_s - 1 \quad (11)$$

By setting L_{sh} to the value in (11), the received sampled signal $y_m^{(0)}(k)$ (8) consists of $L + 1$ paths, in each path the signal having a frame structure with $(P - 1)q$ nonzero symbols followed by $(L + 1)q$ zero symbols. So, after the serial to parallel conversion, the signal on each branch has $P - 1$ nonzero symbols followed by $L + 1$ zero symbols in each frame of $P + L$ symbols (Fig. 5).

Since in each branch of the structure presented in Fig. 4 the signal has a frame structure with zeros periodically inserted at the end of each frame, the MLSE used in each branch can work on a periodic time-varying trellis (Fig. 6).

The construction of the periodic time-varying trellis is based on the fact that, due to the frame structure of the input signal with $L + 1$ zero symbols at the end of each frame, the trellis ends periodically in zero state. Since the zeros have known positions into the input signal, the number of states used to construct such trellis can be reduced. For the example considered in Fig. 6, instead of having a number of states $3^L = 9$ at each instant, we have in a frame duration, at the beginning of the frame a state number increasing from 1 to $2^L = 4$ states. In the frame duration the number of states remains constant at 4 states, and at the end of the frame the number of states decreases from 4 states to 1 state. So the MLSE complexity introduced by the presence of the zero symbols in the received signal is reduced by reducing the number of states of the trellis.

In the next section it will be shown by simulation the performances of the LPTVMA system with the above proposed equalization technique.

4. SIMULATION RESULTS

The multiple access system model used in simulations is depicted in Fig. 1. The number of samples per symbol is $N_s = 16$. The symbols belong to a BPSK constellation. The

frame structure of the ZP signal is defined by the parameters $P = 25$, $Q = qN_s = 80$ and the channel order L . The shaping filter is a SRC FIR filter of order $L_{\text{sh}} = 95$ and rolloff factor $\alpha = 0.5$. The number of users in the system is $M = 10$, which is, with the above choice for the system parameters, the maximum number of users (6). We consider propagation channels of order $L = 3$. The channel multipaths have Rayleigh distributed amplitudes. The channel is considered stationary for the transmission duration and 50 channel realizations are used for BER computation. The equalizer is an MLSE implemented by a parallel trellis Viterbi algorithm (Fig. 4) and uses the periodic time-varying trellis.

The LPTVMA system performances are compared with the performances of the CIBS-CDMA system [2]. The CIBS-CDMA system uses orthogonal Walsh-Hadamard sequences instead of orthogonal carrier frequencies to achieve user orthogonality. In this case the period of the Walsh-Hadamard sequence is $N_s = 16$ and is equal with the number of columns of the matrix interleaver $Q = N_s$. The maximum number of users is $M = 16$. The same channels as for the LPTVMA system are used. The equalizer is an MLSE using the periodic time-varying trellis.

First the users are assumed to be quasi-synchronous in both systems, so that the common channel order L includes users relative delays. Second the users are assumed asynchronous, with relative delays between users, expressed in number of sample/chip duration, uniformly distributed in the interval $\{0, 1, \dots, N - 1\}$, where N is the matrix interleaver period. In this case the common channel order L cannot include user relative delays and MUI occurs.

Comparisons are also carried out with respect to an FDMA system, since, in the LPTVMA system, matrix interleavers are used to spread an FDMA signal. In the FDMA system the channel seen by each user is considered flat fading so, at the reception, the equalization is simply realized by the division with the corresponding channel attenuation. Same parameters as for LPTVMA system are used.

Simulations results for LPTVMA, CIBS-CDMA and FDMA systems are presented in Fig. 7. When the users are quasi-synchronous, the performances of the LPTVMA and CIBS-CDMA systems are very close. The CIBS-CDMA system has a slight advantage over the LPTVMA system, since in the LPTVMA system user orthogonality is not perfect and there is some spectral overlapping.

When the users are asynchronous, the LPTVMA system still has good performances while the CIBS-CDMA system cannot cope with this scenario. This result could be explained by the fact that, in the LPTVMA system, user orthogonality is realized in the frequency domain and the MUI is still small even when users are asynchronous. For CIBS-CDMA systems, since the common channel L order cannot include the users relative delays, user orthogonality, obtained

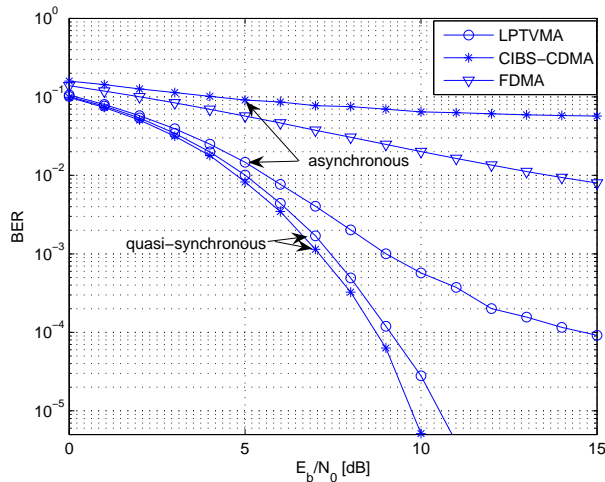

Figure 7: The performances of the LPTVMA system compared to CIBS-CDMA and FDMA systems

through the use of Walsh-Hadamard sequences, is destroyed by the multipath propagation. This is the main advantage of the proposed system and hence the redundancy introduced by the use of the ZP technique could be reduced.

The performances of the LPTVMA system are better than those obtained for a classical FDMA system due to the frequency diversity obtained through the use of matrix interleavers. In this case there is no difference between quasi-synchronous and asynchronous users.

5. CONCLUSIONS

In this paper we have shown how MLSE can be efficiently implemented for LPTVMA systems. It has been shown that, due to the presence of the ZP technique and matrix interleavers the equivalent channel to be equalized is a zero-pad channel. The zero-pad nature of the equivalent channel is also a consequence of the choice of the matrix interleavers. Thus a spread spectrum signal is obtained at the matrix interleaver output. MLSE can be efficiently implemented in zero-pad channels by using a parallel trellis Viterbi algorithm. If BPSK modulated input symbols are used, the complexity of the MLSE goes from 2^L states to 3^L states due to the presence of padding zeros in the received signal. The complexity of the MLSE can be reduced by using the fact that the padding zeros have known positions in the received signal. Hence a periodic time-varying trellis has been proposed. Simulations have shown that, with quasi-synchronous users, the LPTVMA system with the proposed MLSE has almost the same performances as the CIBS-CDMA system. When users are asynchronous and using only equalization techniques, the LPTVMA system exhibits much better performances than the CIBS-CDMA system. Comparisons with the FDMA system showed the effectiveness of the frequency diversity obtained through the use of matrix interleavers in the LPTVMA system.

The principles presented in this paper for the periodic time-varying trellis construction could be applied for the MLSE of other communication systems (e.g. CIBS-CDMA systems) where known symbols are periodically inserted into

the emitted signals.

REFERENCES

- [1] W. Chauvet, B. Cristea, B. Lacaze, D. Roviras, and A. Duverdier, "Design of orthogonal LPTV filters: Application to spread spectrum multiple access," in *Proc. ICASSP*, 2004. Montreal, Canada.
- [2] S. Zhou, G. B. Giannakis, and C. Le Martret, "Chip-interleaved block-spread code division multiple access," *IEEE Trans. Commun.*, vol. 50, pp. 235–248, Feb. 2002.
- [3] D. McLernon, "One-dimensional linear periodically time-varying structures: derivations, interrelationships and properties," *IEE Proceedings - Vision, Image & Signal Processing*, vol. 149, Oct. 1999.
- [4] B. Cristea, B. Escrig, B. Lacaze, D. Roviras, and W. Chauvet, "Synchronization algorithm for LPTV-based spread spectrum signals," in *Proc. EUSIPCO*, 2004. Vienna, Austria.
- [5] B. Cristea, D. Roviras, and B. Escrig, "Multipath effect mitigation in LPTV-based multiple access system," in *Proc. EUSIPCO*, 2005. Antalya, Turkey.
- [6] N. C. McGinty, R. A. Kennedy, and P. Hoeher, "Parallel trellis Viterbi algorithm for sparse channels," *IEEE Commun. Lett.*, vol. 2, pp. 143–145, May 1998.
- [7] O. Y. Takeshita and D. J. Costello, Jr., "New deterministic interleaver designs for turbo codes," *IEEE Trans. Inform. Theory*, vol. 46, pp. 1988–2006, Sept. 2000.
- [8] J. G. Proakis, *Digital Communications*. New York: McGraw-Hill, fourth ed., 2001.