



HAL
open science

Faulting original McEliece's implementations is possible

Vincent Giraud, Guillaume Bouffard

► To cite this version:

Vincent Giraud, Guillaume Bouffard. Faulting original McEliece's implementations is possible: How to mitigate this risk?. Workshop on the Security of Software/Hardware Interfaces, Guillaume Hiet; Jan Tobias Mühlberg, Jul 2023, Delft, Netherlands. hal-04089762

HAL Id: hal-04089762

<https://hal.science/hal-04089762>

Submitted on 5 May 2023

HAL is a multi-disciplinary open access archive for the deposit and dissemination of scientific research documents, whether they are published or not. The documents may come from teaching and research institutions in France or abroad, or from public or private research centers.

L'archive ouverte pluridisciplinaire **HAL**, est destinée au dépôt et à la diffusion de documents scientifiques de niveau recherche, publiés ou non, émanant des établissements d'enseignement et de recherche français ou étrangers, des laboratoires publics ou privés.



Distributed under a Creative Commons Attribution 4.0 International License

Faulting original McEliece’s implementations is possible

How to mitigate this risk?

Vincent Giraud

Ingenico
École Normale Supérieure, DIENS, CNRS,
PSL University, Paris, France
Email: vincent.giraud@ens.fr

Guillaume Bouffard

National Cybersecurity Agency of France (ANSSI),
École Normale Supérieure, DIENS, CNRS,
PSL University, Paris, France
Email: guillaume.bouffard@ens.fr

Abstract—Private and public actors increasingly encounter use cases where they need to implement sensitive operations on mass-market peripherals for which they have little or no control. They are sometimes inclined to attempt this without using hardware-assisted equipment, such as secure elements. In this case, the white-box attack model is particularly relevant and includes access to every asset, retro-engineering, and binary instrumentation by attackers. At the same time, quantum attacks are becoming more and more of a threat and challenge traditional asymmetrical ciphers, which are treasured by private and public actors.

The McEliece cryptosystem is a code-based public key algorithm introduced in 1978 that is not subject to well-known quantum attacks and that could be implemented in an uncontrolled environment. During the NIST post-quantum cryptography standardization process [17], a derived candidate commonly refer to as *classic* McEliece was selected. This algorithm is however vulnerable to some fault injection attacks while *a priori*, this does not apply to the original McEliece. In this article, we thus focus on the original McEliece cryptosystem and we study its resilience against fault injection attacks on an ARM reference implementation [18]. We disclose the first fault injection based attack and we discuss on how to modify the original McEliece cryptosystem to make it resilient to fault injection attacks.

Index Terms—White-box attack model, Post-quantum cryptography, Binary Instrumentation, McEliece.

1. Introduction

For many sectors, the implementation of sensitive operations, such as authentication, payment, or protection of intellectual property, increasingly targets personal embedded devices such as smartphones. These kinds of peripherals are often called Customer Off-The-Shelf (COTS) devices, since they aim for the general public, and are designed with mass-market constraints such as a strong sale price limitation. Hence, despite the potentially high number of executable sources present on the platform, they often do not have hardware security mechanisms such as secure elements or secure enclaves. Even when these features are embedded in the system, they may not be accessible to third-party industrial actors, for commercial reasons. Such stakeholders might thus try to develop alternative ways to address the lack of trust in these environment, which is also relevant with the rapid growth of Bring

Your Own Device (BYOD) policies allowing employees to use their own personal devices, such as smartphones, laptops, and tablets, for work-related activities.

Providing sensitive operations mainly implies exploitation of cryptographic assets. They can be used to encrypt, decrypt, or sign a content. A company choosing not to rely on hardware security mechanisms must endorse full responsibility for the protection of these mechanisms. This situation led to the definition of the *white-box attack model*, which refers to attackers having all powers on the execution environment. In essence, it refers to the case of trying to protect assets on a platform where a hostile actor is root, with the ability to read, write, or instrument everything [4]. In particular, we refer to the implementation of cryptographic algorithms in this context as the White-Box Cryptography (WBC) security model [8]. Companies operating these algorithms face a significant challenge: preventing attackers from recovering secrets in this type of scenario. In the case of the AES, contests [3] have shown that implementations that are not broken in less than two weeks in the WBC attack model are very rare. To increase this time period, protections will be embedded against reverse engineering and binary instrumentation; however, these measures tend to significantly increase the resulting binary size, decrease performance, and thus, impact usability. In concrete use cases, developers will put in place a complete replacement of the sensitive code on a regular basis [23]; however, these updates are not easy to maintain owing to mobile network limitations, mainly availability, cost and bandwidth. Another problem affecting implementation of cryptography in the white-box model is code porting, meaning efforts to copy them on another device to circumvent protections.

In parallel in recent years, the risks associated to cryptographic attacks by quantum computers received an increasing attention with the release of the first quantum hardware. This mode of functioning disrupts the conventional premises of computations and the axioms of cryptography. In this context, called post-quantum cryptography, traditional asymmetrical ciphers are affected, especially RSA, while the impact on symmetrical ciphers is rather limited. In response, the National Institute of Standards and Technology (NIST) initiated a process to determine public key algorithms suitable for this model [17]. Both French [16] and German [13] information security agencies have introduced the need to transition from the current cryptosystems to post-quantum-compatible ones.

In light of these elements, systems and services developed today should consider this threat.

At this point, industrials wishing to implement asymmetrical cryptographic algorithms in an uncontrolled environment or in COTS face many challenges: resisting as long as possible against attackers able to fully instrument their implementation, resisting against quantum attacks, producing sufficiently lightweight binaries, and updating them regularly through mobile networks.

In this study, we explored the security of the McEliece cryptosystem which is an interesting candidate that is quantum-safe and seems to be more suitable for uncontrolled environments. In our study, we focused on the possibility of using McEliece and the security problems of using this cryptosystem in the white-box context. For the rest of this article, McEliece cryptosystem refers to the original McEliece.

1.1. The McEliece Cryptosystem

Introduced in 1978 [15], the McEliece cryptosystem is an asymmetric cipher that employs a (n,k) -linear error-correcting code \mathcal{C} (correcting up to t errors) with a fast decoding algorithm and linear operations, as illustrated in Figure 1, where $M_{a,b}(\mathbb{F}_2)$ denotes a matrix of size a, b , containing elements in the finite field of order 2. In this era, its large key sizes have made it less favored than RSA; however, this criterion is now less significant because of hardware developments, and we can now observe implementations tailored for micro-controllers [12].

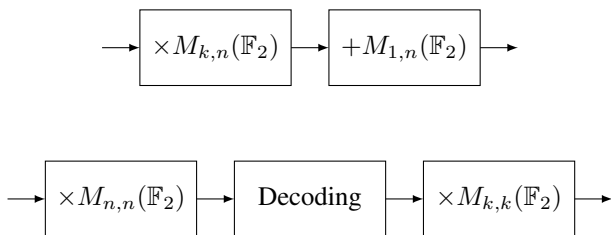

Figure 1: Representation of the operational principles in the McEliece cryptosystem. Above is the encryption, below is the decryption.

To encrypt a clear-text block m , it must be considered as a vector of k bits, and multiply it with a (public) matrix $G' = S \times G \times P$ of size k, n , which is the multiplication between three distinct ones: a random $k \times k$ invertible matrix S used to scramble the data; G , a generator matrix for \mathcal{C} ; and a random $n \times n$ permutation matrix P (i.e. having a single nonzero entry in each row and column). Errors are then added voluntarily with a random vector e of Hamming weight below t to compute the encrypted block $c = mG' + e$. To decrypt a cipher-text block c , one must be in possession of the three secret matrices S , G and P separately, to first cancel the permutation, i.e. compute $a = cP^{-1}$, (quickly) decode b from a with the error-correcting code \mathcal{C} , and then unscramble the data i.e., compute $m = bS^{-1}$. An attacker intercepting the message c would have to find the nearest codeword of the code generated by G' seen as a general linear code, which is known to be NP-hard [2]. An alternative offensive approach consists in attempting to recover the structure

of the underlying code \mathcal{C} . The original proposal relies on binary Goppa codes, which so far remain one of the few families of codes which have largely resisted attempts at devising such structural attacks.

In all cases, since the McEliece cryptosystem mainly consists of linear applications that can be modeled as matrix multiplications, it has significant performance potential. These operations can be accelerated by dedicated hardware, such as Graphics Processing Units (GPUs), or by suitable instruction set extensions, particularly Single Instruction on Multiple Data (SIMD) ones. These features are widely popular in different research topics and can be applied directly in this context. However, many devices targeted by McEliece implementations do not provide them, especially inexpensive micro-controllers.

The asymmetry of this algorithm is valued in the industry: having distinct public and private keys provides more flexibility when designing use cases, and is useful when conceiving secure communications or content delivery services, for example. This attribute has been presented by many other ciphers based on factorization or lattices. However, these paradigms create many difficulties when considering white-box implementations. To the best of our knowledge, this mode of execution usually relies heavily on precomputed intermediate variables; however, these are too large for the aforementioned algorithms. For example, factorization implies operation on very large numbers. For both computation time and storage size reasons, precomputing them is completely out of reach, making translation to the white-box model complex. The McEliece cryptosystem, which embeds linear operations, provides opportunities to address this issue.

1.2. State-of-the-art McEliece Cryptosystem Security

When exploring ciphers deemed reliable in a post-quantum context, the McEliece cryptosystem is a frequent candidate. In the fourth round of the aforementioned NIST contest, which began at the end of 2016 [17], one candidate that still remained, *Classic McEliece*, was inspired by the McEliece specification. In the meantime, PQCRYPTO, a research group specialized in cryptography in the post-quantum context, recommended the use of the original McEliece cryptosystem, with only bigger keys than usual to consider the threat of quantum-based attacks [20, section 4]. Additionally, the Bundesamt für Sicherheit in der Informationstechnik (BSI) also mentions it in its recommendations concerning quantum-safe cryptography [14, page 29].

In addition to its estimated robustness in a post-quantum context, this cryptosystem provides good resistance against attacks by leveraging fault injection. Indeed, when exploiting the private key during the decryption process, a major operation is decoding the intermediary data using a linear code, as illustrated in Figure 1. If one naively applies corruption during the computation, the errors might be inherently corrected, thus voiding the intrusion. On the one hand, this strength of the McEliece cryptosystem is reflected in the scientific literature [7] where authors focused on the theoretical resistance of the algorithm against fault injection attack. They did not succeed in obtaining the private key. To the best of your

knowledge, this work is the only one where the original McEliece cryptosystem algorithm is studied against hardware fault attacks.

On the other hand, NIST candidate Classic McEliece, has been the subject of such attacks [6] [19] [24]. The Goppa codes of a Niederreiter cryptosystem, which are derived from McEliece, have been the subject of a fault injection based attack explained in [10]. These elements make it opportune to follow the PQCRYPTO recommendations and focus on the original McEliece cryptosystem.

1.3. The threat of hardware attacks on the White-Box Cryptography model

The white-box security model assumes that attackers possess complete control over an implementation, requiring various features to impede secret extraction and make it as challenging and costly as possible. Binary obfuscation [22] is a feature that significantly complicates reverse engineering. In the white-box model, robustness is essential to enable implementations to maintain their reliability over an extended period, resulting in fewer replacements and lower usage of mobile networks.

Hardware attacks form the basis of many effective offensives against white-boxes implementations [4]. When these attacks are translated into the software world, they can often bypass the complexity and obfuscation mentioned earlier, thereby jeopardizing the overall feasibility of white-box implementations. As a result, what may have taken days or weeks to break can be achieved in less than one day. Differential Fault Analysis (DFA) on Advanced Encryption Standard (AES) serves as an example and is applicable to both hardware [11] and software [21]. From perspective of an attacker, while the former provides an offensive against an uncontrolled platform, the latter offers a significant operational shortcut despite the controlled platform.

Research about execution perturbation is essential to reinforce today's implementation prototypes. As part of this effort, offensive investigations have been conducted on the McEliece cryptosystem because preventing fault attacks is crucial. To simulate fault injection attacks easily, binary instrumentation tools such as Rainbow¹ and QBDI² can be employed. These tools enable the efficient scrutiny of specific behaviors and precise modifications at specific times. Moreover, these features can be leveraged to satisfy user-specified real-time conditions.

1.4. Contribution

Our main contributions are divided into three parts:

- 1) we present a new fault injection based attack against a typical, common implementation [18] of the McEliece cryptosystem on ARM targets;
- 2) we discuss the applicability of this attack;
- 3) we propose a variant of the McEliece cryptosystem expected to be intrinsically resistant to our attack and thus more suitable for use in uncontrolled environments as expected in

the WBC model.

The remainder of this article is organized as follows. In Section 2, we present an attack based on fault injection that targets ARM reference implementation [18] of the McEliece cryptosystem. Section 3 discusses how our findings impact McEliece implementations in the WBC security model. In Section 4, we introduce a variant of McEliece cryptosystem to be immuned to our attack. Finally, Section 5 offers concluding remarks and describes our future works.

2. Faulting McEliece implementation

We conducted an investigation into the vulnerability of the McEliece cryptosystem for fault injection. As mentioned previously, this cipher is known for its robustness against such efforts, and this aspect has already been studied. However, because successful attempts are aimed at the NIST candidate named Classic McEliece, or towards the Niederreiter cryptosystem, we decided, to push further the research into the original McEliece cryptosystem, to target implementations. This initiative was linked to the study of the possibility to implement it in uncontrolled environment. As explained in subsection 1.3, many successful attacks on these implementations result from identical attacks intended for application on hardware. Identifying a vulnerability through a fault injection attack will require protecting software implementation against exploitation of this attack.

2.1. Obstacles against efficient fault injections attacks

In [18], Petrvalsky *et al.* demonstrated that a side channel attack can be conducted during the decryption process when matrix multiplications are implemented using the conventional method. In the power traces, one can identify the pattern corresponding to modulo 2 addition. When a vector with a Hamming weight of 1 is inputted, it is possible to infer the position of the only set bit of the corresponding line in the permutation matrix owing to the temporal position of this pattern. Once the permutation matrix is recovered, the rest of the private key can be mathematically computed.

We studied how matrix multiplication in the McEliece cryptosystem reacts to fault injections. The main difficulty for an attacker is that the recovery of information on intermediate data seems impossible, as there are only two possibilities that can be observed at the global output of the decryption process: either (1) the decoding operation corrects the errors, making it appear as if the fault never happened, or (2) we have modified the data too much, resulting in an invalid or corrupted output. To overcome this difficulty, we developed an offensive process that allows the acquisition of information based on the final output of the algorithm, either a correct or an error message.

The first step of the decryption process involves applying a permutation matrix that has only one bit set in each row or column. The attacker's goal is to determine the matrix. A fundamental property of these linear applications is that they do not alter the Hamming weight,

1. See github.com/Ledger-Donjon/rainbow

2. See github.com/QBDI/QBDI

which means that the output will have the same number of set bits as the input. Furthermore, we know the size of this matrix, which is the ciphered block, denoted by n . Another important parameter of a specific implementation of the McEliece cryptosystem is t , the maximum number of bit errors the code can correct.

If we were able to scrutinize the output of this matrix, its recovery would be easy. It would be sufficient to use an input vectors with only one-bit set and to observe where they end up in the output. However, this is not possible because the internals of the algorithm are either impossible to reach or intentionally complex. Therefore, we investigated methods to infer information about this part based on the state of the global output. However, this possibility seems mathematically out of question, because the McEliece cryptosystem specifies the use of a scrambling matrix to provide diffusion in the data, along with a decoding operation, which is a surjective function.

2.2. Attack methodology

Figure 2 illustrates the multiplication of a vector by a permutation matrix, which should be considered. The conventional method of implementation is to loop over each bit element of the vector and perform, if the current bit is set, a XOR operation between the corresponding line of the matrix, and an accumulator. It is important to use the XOR operation specifically rather than addition, because we are working in the \mathbb{F}_2 finite field. As previously mentioned, the Hamming weight of the accumulator vector at the end of this process should be the same as that of the input. This way of implementing matrix multiplications is common and is described in [18]. We are targeting this implementation with the scope of fault injection attacks.

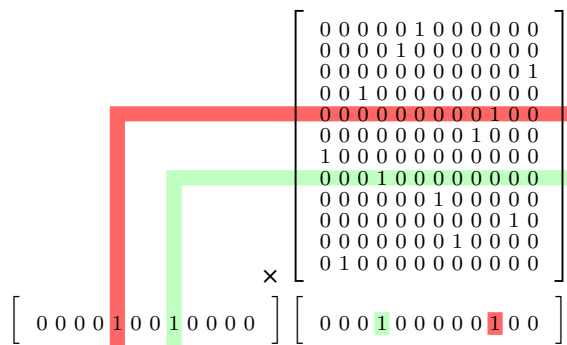

Figure 2: Illustration of multiplication between a vector and a permutation matrix, here with $n = 12$.

As a side note, since the McEliece cryptosystem involves keys with significant sizes, optimizing memory management is paramount. For example, using the standard `bool` type, or a whole variable to store each of the bits would be wasteful: on a 32-bit processor, it would imply to ignore 31 out of the 32 bits of variables.

Instead, a preferred approach is to fill the whole variables with useful bits only, even if it means using bitwise operations, and bit masking. This method is more efficient, and becomes mandatory on a target platform with memory limitations. This is often the case on 8-bit systems, which

have been targeted by some implementations [12]. While these constraints are not as hard on more powerful or usual platforms, such as computers based on a x86 processor, wasting 31 bits out of 32 is still quite inefficient. In this article, the size of the variables in bits will be denoted as p .

In this attack, we target the XOR operation between the accumulator and specific lines of the matrix. In the ARM instruction set [1], instruction representation contains a 4-bit long operation codes located between the 21st and 24th bits, as shown in Figure 3.

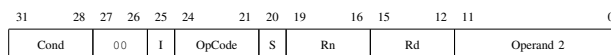

Figure 3: Representation of a 32-bit instruction designed for ARM processors [1].

The operation code for XOR operation, called EOR, has a value 0001. By making a single bit change, we can switch it to an RSB instruction with the value 0011, which performs subtraction between the operands. The use of the XOR operation is responsible for preserving the Hamming weight property, as there is only one bit set in each row of the matrix. For each one in the input vector, one and only one bit is set in the result. Replacing it with subtraction eliminates this property. The XOR operation is performed between the accumulator and specific lines of the matrix. A naive implementation is shown in Listing 1, with $p = 32$, and $n = 1024$. For each bit in the input vector, we check if it is set, and if so, we XOR the corresponding line of the matrix with the accumulator variable by variable.

Listing 1: Naive vector-matrix multiplication in C-code.

```
uint32_t accu[1024/32] = {0};
for(int i = 0; i < 1024; i++) {
    if((vector[i/32] >> (31-(i%32))) & 0x01) != 0) {
        for(int j = 0; j < (1024/32); j++) {
            accu[j] = accu[j] ^ matrix[i*(1024/32)+j];
        }
    }
}
```

The ARM built version of Listing 1 is shown in Listing 2. In this listing, the instruction of interest is located at address `0x10698` (in red in Listing 2).

Listing 2: Built version of vulnerable code from Listing 1 into ARM-assembly.

```
@ | Instruction |
@ | Add. | bin. value | mnemonic |
10660 e51b300c ldr r3, [fp, #-12]
10664 e1a03103 lsl r3, r3, #2
10668 e24b2004 sub r2, fp, #4
1066c e0823003 add r3, r2, r3
10670 e5131024 ldr r1, [r3, #-36]
10674 e51b2008 ldr r2, [fp, #-8]
10678 e1a03002 mov r3, r2
1067c e1a03083 lsl r3, r3, #1
10680 e0832002 add r2, r3, r2
10684 e51b300c ldr r3, [fp, #-12]
10688 e0822003 add r2, r2, r3
1068c e59f30d8 ldr r3, [pc, #216]
10690 e08f3003 add r3, pc, r3
10694 e7933102 ldr r3, [r3, r2, lsl #2]
10698 e0212003 eor r2, r1, r3
1069c e51b300c ldr r3, [fp, #-12]
106a0 e1a03103 lsl r3, r3, #2
106a4 e24b1004 sub r1, fp, #4
106a8 e0813003 add r3, r1, r3
106ac e5032024 str r2, [r3, #-36]
```

By changing only one bit, we can shift from EOR instruction (0xe0212003) to RSB instruction (0xe0612003), whose provides a subtraction between the operands.

Thus, our goal is to cause corruption at the end of the global output, depending on attributes of the multiplication result. The considered fault model implies a one-bit change in the program’s instructions, either before they are loaded in volatile memory (in RAM), or in the processor caches, because we have both temporal and spatial proximity: the selected instruction is likely to be in a `for` loop executed many times, with few other manipulations inside.

An important property of linear correcting codes is that a bit vector filled with zeros is inevitably a valid code. Because the coding operation can be performed using only matrix multiplication, it is necessary the case that a null vector is the only code that can possibly represents a null vector.

During normal operations, sending input vectors with a Hamming weight of less than t should not provoke any error or message corruption. With the modified instruction, this is completely possible. We thus propose the following approach:

- 1) send an input vector with an Hamming weight of $\begin{bmatrix} t \\ - \\ p \end{bmatrix}$;
- 2) observe the occurrence or absence of corruption or error.

In step 1, the positions of the set bits can be randomly selected. In step 2, the algorithm’s failure to produce correct results indicates that the set bits in the rows of the permutation matrix corresponding to the input vector are not grouped together in the same p columns. Specifically, if the set bits were in the same group, it would be impossible to end up with an accumulator that has a Hamming weight above t .

This approach provides crucial data about the permutation matrix. By repeating it many times with different inputs, one can considerably reduce the size of the possible matrices, and each of the remaining matrices can be tested by decrypting valid vectors with a high Hamming weight and looking for errors. If one knows the permutation matrix, it becomes possible to attack the error-correcting and scrambling matrices, as described in [18], enabling complete recovery of the private key.

2.3. Details on a single iteration

In order to ease understanding, let’s focus on an example multiplication with small parameters: $n = 12$, $p = 4$, and $t = 5$. Since we have $\lceil \frac{5}{4} \rceil$, we need to input vectors with a Hamming weight of 2. This is shown in Figure 2, which illustrates an unmodified process. As expected, the output vector has the same Hamming weight as the input.

Now let’s consider a process that has encountered a fault, indicated by the replacement of the XOR instruction with an RSB. This operation is depicted in Figure 4. For each row processed in the matrix, 4 bits will be subtracted from the accumulator at a time. The Hamming weight of the output vector has been modified. In Figure 4a, the

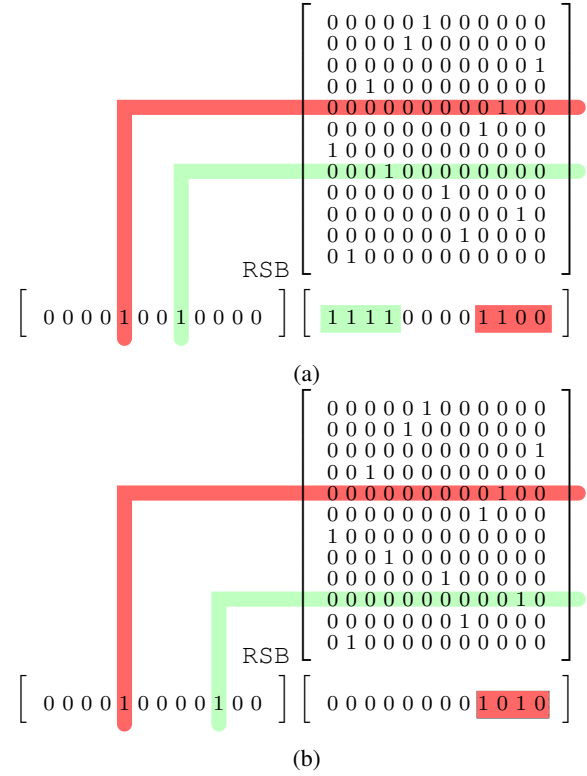

Figure 4: Illustration of faulty multiplications between a vector and a permutation matrix, with EOR replaced by RSB. Figure 4a triggers an error or corruption, whereas Figure 4b does not.

first bit set in the input vector now generates 2 ones, because $0 - 4 = -4$, and the second one generates 4 ones, because $0 - 1 = -1$. Note that in ARM, negative numbers are represented using two’s complement. Conceptually, we can also consider these as 4-bit unsigned variable. Despite the integer overflow, the resulting bits are the same. Additionally, carries are not applied between variables, so empty groups will remain empty.

The Hamming weight of the output vector has increased to 6, which is above t , and will result in an error or corruption at the end of the global algorithm. This indicates that the matrix’s lines corresponding to the ones in the input vector have their set bits in different 4-bit columns. In Figure 4b, we illustrate a case where the set bits of the relevant rows are in the same 4-bit group, resulting in an output vector with only two set bits. The maximum Hamming weight we could theoretically have in the output is p , since only one variable would be affected. In such a case, the correcting code would be able to retrieve the null vector.

By reiterating this operation with various input vectors with the same weight, one can group the matrix’s rows going in the same group, without knowing which ones. This represents a significant reduction in the space of the possible permutation matrices.

2.4. Resulting metrics

By exploiting this attack, the key space can be significantly reduced. The extent of reduction varies greatly depending on the algorithm’s parameter and the size of

data on the target platform. As for the permutation matrix, it has a size of $n \times n$ bits. Due to its nature, the associated entropy is not $\log_2(2^{n^2})$ as it would be with a regular matrix, but $\log_2(n!)$, which is the number of possible permutations of the elements of an n -bit vector. In the McEliece cryptosystem, the original specification provides example parameters with $n = 1024$ [15], but today, bigger sizes are commonly used. The PQCRYPTO recommendations mention parameters with $n = 6960$ [20, section 4].

The above approach determines whether the selected rows each have their set bit in different groups of p columns. However, by repeatedly iterating it, sets of rows having their set bit in the same group can be formed without being able to identify which rows belong to which set. With enough iterations, obtaining a complete partition becomes achievable. In this case, the remaining entropy is $\log_2(p!^{\frac{n}{p}} \times \frac{n!}{p!})$ when $\frac{n}{p}$ is an integer.

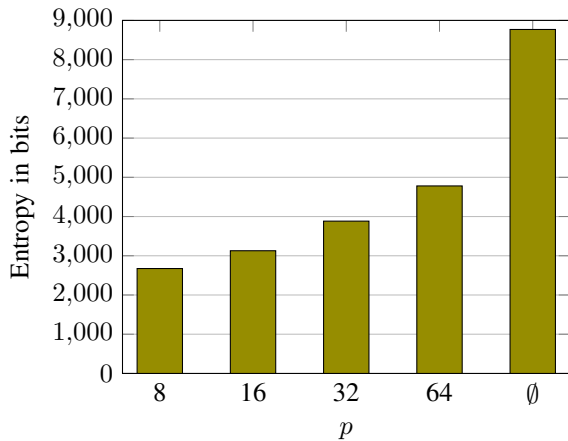

Figure 5: Comparison of the permutation matrix’s entropy before and after the attack, with multiple p values, for $n = 1024$. The \emptyset value occurred prior to the attack.

As expected, the entropy decreases with smaller variables size. Figure 5 shows entropy values for the parameter $n = 1024$, which is the one suggested in the original McEliece specification, but for different variables size. The \emptyset value represents the entropy before the attack. Even with 64-bit registers, a significant reduction in possibilities occurs.

The relative proportions of remaining entropy remain in the same order of magnitude even when n varies, as observed in Figure 6, which shows the results for $n = 6960$, the suggested size in the PQCRYPTO recommendations [20, section 4].

In our experiments, only the RSB instruction has been considered as it is the only operation code reachable with only one bit change having desirable effects. Indeed, AND and TEQ cannot induce any Hamming weight change in the accumulator variable. Such an injection has been demonstrated as possible in hardware [6]. It is also reproducible in software using binary instrumentation tools. In the latter case, there is no reason to restrict the change to one bit. Exploring all the other operation codes can possibly lead to increased performances, by developing and exploiting a different routine. In hardware attacks,

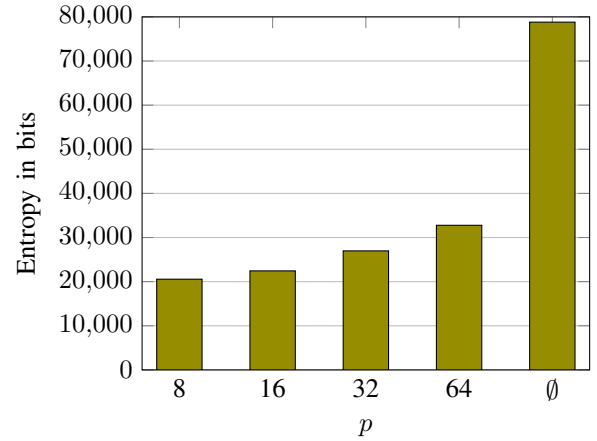

Figure 6: Comparison of the permutation matrix’s entropy before and after the attack, with multiple p values, for $n = 6960$. The \emptyset value occurred prior to the attack.

affecting multiple bits is plausible, and expecting bigger changes in the operation code can be conceivable.

The transposition of this hardware-based attack to the software context is not only feasible but raises many questions, particularly on its impact over white-box implementations.

3. Exploitation of the fault attack on implementation of the McEliece cryptosystem

We introduced the first fault injection based attack on the McEliece cryptosystem. This presented attack in the previous sections can be applied since an attacker is able to shift a bit, on the one hand, on the typical implementation on a component through fault injection attack [5] or, on the other hand, with binary instrumentation on software application on an uncontrolled environment. Our attack does not target the McEliece cryptosystem specification, but rather a conventional method of implementing it [18], specifically the depermutation of the input.

When one is in possession of an unobfuscated executable applying the decryption, recovering the key is trivial. Hardware attacks are necessary when it is embedded on a platform on which we cannot run debuggers, for example. With the advent of the white-box security model, however, many industrial actors released obfuscated executables with anti-instrumentation measures, with the hope that an attacker with binary exploitation tools could not recover secrets. If these are not advanced enough, the attack presented here can circumvent them.

Implementation of cryptographic algorithms following the WBC security model are usually based on internal encoding applied to precomputed tables. In such cases, an attack based on data manipulation is called into question: *do the modifications still hold through random bijections?* When the attack is based on instructions manipulation, it seems jeopardized when considering implementations based on precomputation. The targeted instructions are not in the executable, but are exploited in advance during generation of the software. Therefore, it needs to be converted to an attack based on data.

When considering a table of precomputed data, re-computing it can be envisioned. Indeed, the results are the content itself, and one of the two operands of the associated operation is the corresponding index of each value. Using the same example of the XOR instruction, one can simply apply an exclusive-or between the result and its index to recover the second parameter, and eventually recompute the whole table in a faulty way as explained if necessary. This technique is applicable, notably at the end of a WBC protected algorithm without external encoding. It should be noted that it is possible when an implementation follows an open specification: the knowledge required is not only the result and one operand, but also the operation applied itself.

An attack such as the one presented in this study is very likely to affect naively obfuscated implementations without precomputed intermediary results. Control-flow obfuscation and the addition of useless calculation around the desired one do not prevent the existence of the XOR instruction, which is our target of choice.

These implications have major consequences in the exploitation of embedded wireless network capabilities. All industrial actors have interests in providing solutions with a low use of the mobile network usage, as it is expensive for the end-user and its availability cannot be assumed. The existence of white spots makes it hard to rely too much on such communications. The white-box implementation of an algorithm is thus expected to provide many features, such as low data size to reduce the burden of its downloads and robustness, since an easily attackable executable will need to be changed more often, and this will imply more downloads too. These features are all related to the stakes around telecommunications use, and they draw a direct, consequential link between security and mobile networks constraints.

4. A variant of the McEliece cryptosystem immuned to our attack

Our work focuses on decryption in the McEliece specification. Since encryption relies on a public key, attempting to protect it with a WBC security model is unproductive. Therefore, we aim at protecting the private key during the deciphering process. As illustrated in Figure 1, this involves hiding the permutation matrix P , the scrambling matrix S , and the generator matrix G of the underlying linear code.

One might be tempted to simply merge the permutation and scrambling matrices each with random linear applications that could be cancelled outside of the algorithm. However, this method introduces risks towards attacks based on interpolation. To properly protect these assets, the techniques used cannot rely exclusively on linear fusions.

Linear mathematical operations, which make up almost all of the McEliece cryptosystem, are easily precomputable, despite the potentially large size of the associated matrices. This was done, for example, in the original proposition for a white-box version of the AES [9] when considering the `MixColumns` operation.

The usual technique involves decomposing the entire matrix into smaller ones, as shown in Figure 7, with a

matrix named M , where a is the number of submatrices rows, and b is the number of submatrices columns. Their corresponding linear applications are then precomputed. The size of the submatrices is completely up to the designer and will influence usability: larger submatrices will result in larger precomputed tables and thus a larger white-box implementation. Choosing a submatrix size that is not a total matrix size divider is possible.

$$M = \begin{bmatrix} \begin{bmatrix} M_{0,0} \end{bmatrix} & \begin{bmatrix} M_{0,1} \end{bmatrix} & \dots & \begin{bmatrix} M_{0,b} \end{bmatrix} \\ \begin{bmatrix} M_{1,0} \end{bmatrix} & & & \\ \vdots & & & \\ \begin{bmatrix} M_{a,0} \end{bmatrix} & & & \begin{bmatrix} M_{a,b} \end{bmatrix} \end{bmatrix}$$

Figure 7: Visualization illustrating the decomposition of a matrix in order to make the precomputation of its associated transformation possible.

The resulting tables can be used consecutively by adding their results. If we consider a vector u multiplied with M on its left, then resulting $u \times M$ is composed of b concatenated subvectors:

$$u \times M = \left[\sum_{i=0}^a u_i \times M_{i,0} \parallel \sum_{i=0}^a u_i \times M_{i,1} \parallel \dots \parallel \sum_{i=0}^a u_i \times M_{i,b} \right]$$

The addition themselves should also be precomputed, so that the entire linear application consists solely of tables. Each subvector thus becomes the root result of a precomputed tree. In the context of the McEliece cryptosystem, the XOR operations are used for additions. A tables tree of this kind can be deployed to handle the permutation and scrambling matrix.

However, precomputation is not possible on decoding step in the decryption process, since it operates on an input that is often at least 1024 bits long. As a result, adaptation work is necessary to implement the McEliece cryptosystem in a WBC security model.

One possible approach, illustrated in Figure 8, is to use multiple small correcting codes instead of a single large one. Each code would be associated with its own permutation, but they would all share a common scrambling matrix that would mix the data across the subcodes. However, implementing this method would require modifications not only on the decryption side but also to the encryption process. On the later, the differences are almost invisible to the final user: the subcodes are embedded in the public key, and encrypting still essentially consists in multiplying by one large matrix. However, adding errors must be applied considering each subcode.

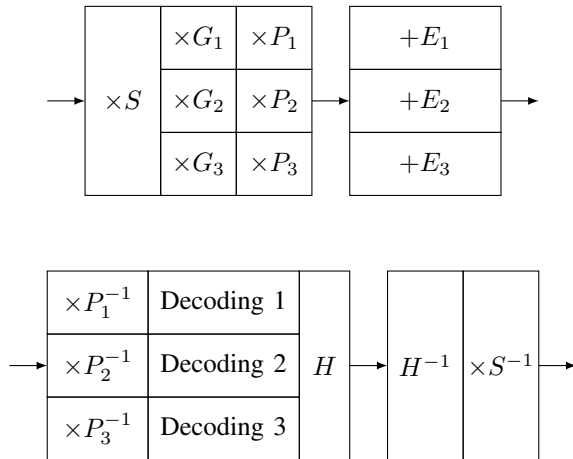

Figure 8: Representation of the operational principles of one explored McEliece cryptosystem modification. Above is the encryption, below is the decryption. In this example, the number of subcodes is set to 3.

To protect the private key during the deciphering step, internal encoding based on random bijections, here named H , could be applied at the end of the subcodes, with their inverses at the beginning of the common unscrambling application. The subpermutations and subcodes could be merged and precomputed together, while the scrambling matrix would be subdivided and precomputed alone.

One crucial aspect to consider in this approach is that the permutation matrices, which are critical to the security of the McEliece cryptosystem, may have less entropy than the large equivalent one. This is due to the fast growth of the factorial function that describes their complexity based on their size. Therefore, the size of the permutation matrices must be chosen carefully, taking into account both security and usability constraints. To ensure the robustness of this idea, many offensive approaches still need to be undertaken.

In this section, we introduce a variant of McEliece cryptosystem aiming at being protected against binary instrumentation, our variant should now be proved to be resistant. This complex part is still an ongoing work.

5. Conclusion

In this article, we described the first fault injection based attack on ARM implementation of the McEliece cryptosystem [18] where we are able to retrieve the private key. Our attack can be exploited anywhere where one can modify a bit: through hardware attack on component or by binary instrumentation on software executed in an uncontrolled environment. Our attack successfully allows a substantial reduction of key space, regardless of the chosen parameters.

We discussed how such an attack could be ported to afflict implementations working in a WBC security model. Given the numerous, powerful, and accessible binary instrumentation tools available, we described how fault injection and side channel attacks can be simulated and their consequences, to find new vulnerability to mitigate.

We presented suggestions to mitigate the exploitability of our attack in an uncontrolled environment. We also

proposed ideas of variants on the McEliece cryptosystem expected to lead to immune implementations so that they can protect keys for a time long enough to allow practical use in real contexts, such as embedded open devices fully mastered by malicious users. Network constraints and limitations on binary updates sizes were major considerations in our design process. However, precomputed tables and their associated sizes can still represent a downside for effective use, notably due to bandwidth constraints. Addressing this issue is crucial to find the most lightweight solution that can effectively hold against binary instrumentation attacks.

Our proposed variant need further works to attest its viability in terms of security. Also, more efforts could be dedicated into the estimation and the management of this implementation's size: being able to make an informed judgment about the trade-off between size, usability and security would be very useful.

Acknowledgements

The authors wish to thank David Naccache for his guidance and support all along this work. They would also like to thank Aline Gouget and Sébastien Varrette for their valuable comments.

References

- [1] ARM Limited. *ARMv8-A Architecture Reference Manual*. ARM Limited, Cambridge, United Kingdom, 2016.
- [2] E. Berlekamp, R. J. McEliece, and H. van Tilborg. On the inherent intractability of certain coding problems (Corresp.). *IEEE Transactions on Information Theory*, 24(3):384–386, 1978.
- [3] Estuardo Alpirez Bock and Alexander Treff. Security Assessment of White-Box Design Submissions of the CHES 2017 CTF Challenge. In Guido Marco Bertoni and Francesco Regazzoni, editors, *Constructive Side-Channel Analysis and Secure Design - 11th International Workshop, COSADE 2020, Lugano, Switzerland, April 1-3, 2020, Revised Selected Papers*, volume 12244 of *Lecture Notes in Computer Science*, pages 123–146. Springer, 2020.
- [4] Joppe W. Bos, Charles Hubain, Wil Michiels, and Philippe Teuwen. Differential Computation Analysis: Hiding Your White-Box Designs is Not Enough. In Benedikt Gierlichs and Axel Y. Poschmann, editors, *Cryptographic Hardware and Embedded Systems - CHES 2016 - 18th International Conference, Santa Barbara, CA, USA, August 17-19, 2016, Proceedings*, volume 9813 of *Lecture Notes in Computer Science*, pages 215–236. Springer, 2016.
- [5] Jakub Breier and Xiaolu Hou. How Practical Are Fault Injection Attacks, Really? *IEEE Access*, 10:113122–113130, 2022.
- [6] Pierre-Louis Cayrel. *Habilitation à Diriger des Recherches*.
- [7] Pierre-Louis Cayrel and Pierre Dusart. McEliece/Niederreiter PKC: Sensitivity to Fault Injection. In *2010 5th International Conference on Future Information Technology*, pages 1–6. ISSN: 2159-7014.
- [8] Stanley Chow, Philip A. Eisen, Harold Johnson, and Paul C. van Oorschot. A White-Box DES Implementation for DRM Applications. In Joan Feigenbaum, editor, *Security and Privacy in Digital Rights Management, ACM CCS-9 Workshop, DRM 2002, Washington, DC, USA, November 18, 2002, Revised Papers*, volume 2696 of *Lecture Notes in Computer Science*, pages 1–15. Springer, 2002.
- [9] Stanley Chow, Philip A. Eisen, Harold Johnson, and Paul C. van Oorschot. White-Box Cryptography and an AES Implementation. In Kaisa Nyberg and Howard M. Heys, editors, *Selected Areas in Cryptography, 9th Annual International Workshop, SAC 2002, St. John's, Newfoundland, Canada, August 15-16, 2002, Revised Papers*, volume 2595 of *Lecture Notes in Computer Science*, pages 250–270. Springer, 2002.

- [10] Julian Danner and Martin Kreuzer. A fault attack on the Niederreiter cryptosystem using binary irreducible Goppa codes. *Journal of Groups, complexity, cryptology*, Volume 12, Issue 1, mar 2020.
- [11] Pierre Dusart, Gilles Letourneux, and Olivier Vivolo. Differential Fault Analysis on A.E.S, 2003.
- [12] Thomas Eisenbarth, Tim Güneysu, Stefan Heyse, and Christof Paar. MicroEliece: McEliece for Embedded Devices. In Christophe Clavier and Kris Gaj, editors, *Cryptographic Hardware and Embedded Systems - CHES 2009, 11th International Workshop, Lausanne, Switzerland, September 6-9, 2009, Proceedings*, volume 5747 of *Lecture Notes in Computer Science*, pages 49–64. Springer, 2009.
- [13] Bundesamt für Sicherheit in der Informationstechnik (BSI). Migration zu Post-Quanten-Kryptografie. Technical report, Aug 2020.
- [14] Bundesamt für Sicherheit in der Informationstechnik (BSI). Quantum-safe cryptography – fundamentals, current developments and recommendations. Technical report, May 2022.
- [15] R.J. McEliece. A Public-Key Cryptosystem Based On Algebraic Coding Theory.
- [16] National Cybersecurity Agency of France (ANSSI). ANSSI views on the Post-Quantum Cryptography transition. Technical report, jan 2022.
- [17] National Institute of Standards and Technology (NIST). Post-Quantum Cryptography Standardization, 12 2016.
- [18] Martin Petrvalsky, Tania Richmond, Milos Drutarovsky, Pierre-Louis Cayrel, and Viktor Fischer. Countermeasure against the SPA attack on an embedded McEliece cryptosystem. page pp. 462.
- [19] Sabine Pircher, Johannes Geier, Julian Danner, Daniel Mueller-Gritschneider, and Antonia Wachter-Zeh. Key-Recovery Fault Injection Attack on the Classic McEliece KEM. *Cryptology ePrint Archive*, Paper 2022/1529, 2022. <https://eprint.iacr.org/2022/1529>.
- [20] PQCRYPTO researchers forum. ICT-645622: Initial recommendations of long-term secure post-quantum systems, 2015. <https://pqcrypto.eu.org/docs/initial-recommendations.pdf>.
- [21] Eloi Sanfelix, Cristofaro Mune, and Job de Haas. Practical attacks against Obfuscated Ciphers. page 38.
- [22] Moritz Schlögel, Tim Blazytko, Moritz Contag, Cornelius Aschermann, Julius Basler, Thorsten Holz, and Ali Abbasi. Loki: Hardening Code Obfuscation Against Automated Attacks. In Kevin R. B. Butler and Kurt Thomas, editors, *31st USENIX Security Symposium, USENIX Security 2022, Boston, MA, USA, August 10-12, 2022*, pages 3055–3073. USENIX Association, 2022.
- [23] Romain Thomas. DroidGuard: A Deep Dive into SafetyNet. In *Symposium sur la sécurité des technologies de l'information et des communications (SSTIC)*, 2022.
- [24] Keita Xagawa, Akira Ito, Rei Ueno, Junko Takahashi, and Naofumi Homma. Fault-Injection Attacks against NIST's Post-Quantum Cryptography Round 3 KEM Candidates. *Cryptology ePrint Archive*, Paper 2021/840, 2021. <https://eprint.iacr.org/2021/840>.