



**HAL**  
open science

## **Fish-friendly trashracks: headloss formula and clogging effect for inclined racks**

Sylvain Raynal, Ludovic Chatellier, Laurent David, Dominique Courret,  
Michel Larinier

### ► **To cite this version:**

Sylvain Raynal, Ludovic Chatellier, Laurent David, Dominique Courret, Michel Larinier. Fish-friendly trashracks: headloss formula and clogging effect for inclined racks. 2nd IAHR Europe Congress, Jun 2012, Munich, Germany. pp.0. hal-04086634

**HAL Id: hal-04086634**

**<https://hal.science/hal-04086634>**

Submitted on 2 May 2023

**HAL** is a multi-disciplinary open access archive for the deposit and dissemination of scientific research documents, whether they are published or not. The documents may come from teaching and research institutions in France or abroad, or from public or private research centers.

L'archive ouverte pluridisciplinaire **HAL**, est destinée au dépôt et à la diffusion de documents scientifiques de niveau recherche, publiés ou non, émanant des établissements d'enseignement et de recherche français ou étrangers, des laboratoires publics ou privés.



## Open Archive Toulouse Archive Ouverte (OATAO)

OATAO is an open access repository that collects the work of Toulouse researchers and makes it freely available over the web where possible.

This is an author-deposited version published in: <http://oatao.univ-toulouse.fr/>  
Eprints ID: 11259

**To cite this version:**

Raynal, Sylvain and Chatellier, Ludovic and David, Laurent and Courret, Dominique and Larinier, Michel *Fish-friendly trashracks: headloss formula and clogging effect for inclined racks*. (2012) In: 2nd IAHR Europe Congress, 27 June 2012 - 29 June 2012 (Munich, Germany).

Any correspondence concerning this service should be sent to the repository administrator:  
[staff-oatao@inp-toulouse.fr](mailto:staff-oatao@inp-toulouse.fr)

# FISH-FRIENDLY TRASHRACKS: HEADLOSS FORMULA AND CLOGGING EFFECT FOR INCLINED RACKS

Raynal Sylvain<sup>1</sup>, Chatellier Ludovic<sup>1</sup>, David Laurent<sup>1</sup>, Courret Dominique<sup>2</sup>, Larinier Michel<sup>2</sup>

<sup>1</sup> Institut Pprime, UPR3346, CNRS, Université de Poitiers, ENSMA, Bd Marie et Pierre Curie, Téléport 2, BP 30179, 86962 Futuroscope, France

<sup>2</sup> ONEMA, Pôle Ecohydraulique, Institut de Mécanique des Fluides de Toulouse  
Allée du Professeur Camille Soula, 31400 Toulouse, France  
Email : Sylvain.Raynal@univ-poitiers.fr

## Abstract

Experimental results for fish-friendly trashracks placed in an open water channel are presented. Trashrack models with different bar shape, spacing and inclination are tested. The numerous configurations provide results on head losses which are fitted by a new formula which takes into account all these parameters. It especially separates the blocking ratio due to bars, which is impacted by the inclination, from that due to transversal elements, such as spacer rows, whose effect on the flow is not altered with the rack inclination. Clogging, which is more likely to occur more on grids with thin space between bars, was simulated with a set of perforated plates. Its influence on head losses has been investigated, and a small adaptation of the formula proposed for clean grids was sufficient to obtain satisfactory results for clogged ones.

## Introduction

The European Union Water Framework Directive, entered into force in December 2000, aims at improving the status of all water bodies and especially the quality of aquatic ecosystems. Ecological continuity, including upstream and downstream migration of fishes, is one of the hydro-morphological elements which sustain the good ecological status of rivers. Moreover, European silver eel population is seriously decreasing (Travade et al. 2010) and this has led to specific protection measures established by the European Council Regulation n°1100/2007. It includes the requirement to reduce the anthropogenic mortality factors, and notably the damages done to downstream migrant silver eels passing through turbines that can be high (Monten 1985; EPRI 2001; Gomes et Larinier 2008). Other amphihaline species, especially salmon and sea trout, and holobiotic species are also concerned by this issue (Larinier and Travade 2002).

Several solutions have been tested to avoid fish passage through turbines and reestablish free downstream migration, and physical screens supplemented by bypasses

is one of the most acceptable and efficient solutions (EPRI 2001, 2002; Larinier and Travade 2002; Travade and Larinier 2006 ; Travade et al. 2010). Existing trashracks are initially designed to protect turbines from large debris. Their large bar spacing (40 to 100 mm) has really low effect for fish protection. These racks can be adapted to become fish-friendly by reducing their bar spacing in order to prevent fishes from entering turbines (bar spacing lower than 20 mm for silver eels). However, preserving downstream migration by stopping fishes also involves guiding them toward bypasses. One way is to incline trashracks (inclination  $\beta \leq 25^\circ$ ), which are conventionally perpendicular to the flow ( $\beta = 90^\circ$ ), and to install bypasses at the top end (Courret et Larinier 2008; Figure 1).

Nonetheless, such modifications may drastically change head losses and the bar closeness will increase rack clogging.



Figure 1 : Existing inclined trashrack with three bypass entrances and with cleaning equipment (Monfourat, Dronne). Photo by O. Guerri.

One of the first head loss formulae was proposed by Kirschmer (1926) for vertical and slightly inclined

trashracks. Since then, other formulae have been proposed, mostly for vertical trashracks, adding for example the effect of horizontal elements (Osborn 1968; Clark and Tsikata 2009). Meusburger (2002) gave a rather complete formula taking into account low bar spacings, several bar shapes, inclined and angled racks and potentially the clogging effect through an additional blocking ratio. Some of these parameters were extracted from the literature, some were obtained from experiments but the possible interdependence between all parameters has not been tested.

In order to check and potentially to extend the applicability of existing formulae to fish-friendly trashracks, an experimental investigation has been carried out testing a large range of configurations. Additionally, clogging effect has been simulated using perforated plates allowing to check Meusburger's formula in clogged trashrack configurations.

Details on the hydraulic installation, measurement systems and our model trashrack are gathered in the "Experimental setup" section. The second one focuses on head losses and proposes a new formula for fish-friendly trashrack. Modifications induced by clogging on head losses are discussed in the third section. The combination of these results is finally summarized and discussed in the conclusion.

## Experimental setup

### Channel and trashrack

The experiments were conducted with a trashrack model placed in an open rectangular channel whose cross-section is 0.9 m deep and 0.6 m wide.

The flow rate at the entrance of the channel is calculated using a Froude similarity and the water level is adjusted with a weir installed at its outlet.

The trashrack is composed by bars, hold by rods at regular distance (250 mm). Spacers, whose diameter is  $D_{sp}=20$  mm, are inserted around rods and their width determines the space between bars. Bars are 0.005 m wide ( $b$ ), 1.3 m long ( $L_G$ ), 0.04 m deep ( $p$ ) and have either a rectangular (PR) or a more hydrodynamic (PH) shape (Figure 2). The spacer width, and therefore the space between bars ( $e$ ), may be 5, 7.5, 10 or 15 mm. The whole trashrack rotates around its bottommost end. Seven inclinations have been tested: 15°, 25°, 35°, 45°, 60°, 75° and 90° (vertical trashrack).

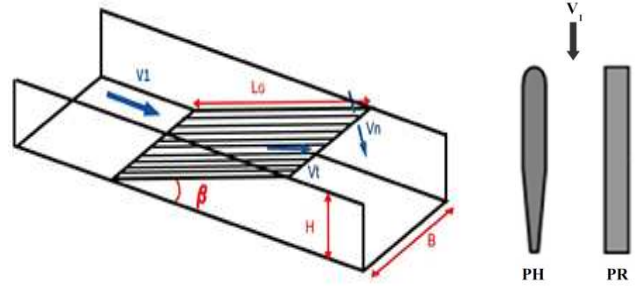

Figure 2 : 3D schematic view of the inclined trashrack (left) and the two bar shapes tested (right).

### Head losses

The flow rate  $Q$  and the upstream and downstream water depths  $H_1$  and  $H_2$  were sufficient to obtain the head loss due to the trashrack  $\Delta H$ . These three variables directly provide the upstream and downstream mean velocities  $V_1$  and  $V_2$ . Using  $H_1$ ,  $V_1$ ,  $H_2$  and  $V_2$  in the generalized Bernoulli equation, the head loss of the current experiment is easily obtained. The head loss of the trashrack is then deducted by subtracting the part due to the channel, obtained from tests in the empty channel. Finally, the trashrack head loss coefficient  $\xi$  result from  $\Delta H$  and  $V_1$ .

### Clean and clogged trashracks

The obstruction ratio is an important parameter of clean racks. It is computed by adding the contributions of bars  $O_b$  and horizontal elements  $O_{sp}$ .

$$O = O_b + O_{sp} \quad (1)$$

Another parameter,  $O_{sp,H}$ , was also created to calculate the obstruction of horizontal elements on the water depth.

$$O_{sp,H} = (1 - O_b) * \frac{N_{sp,im} * D_{sp}}{H_1} \quad (2)$$

In addition to these measurements on clean racks, clogged grids were also experimented. Debris were materialized by perforated thin plates, whose porosity and therefore blockage ratio  $C_0$  is well known and which cover either the whole rack, its upper part, its lower part, or both parts. This led to a clogged rack length  $L_c$ , which equals zero for clean racks and which may equal  $L_{g,im}$  when clogging affects the whole rack. The clogging ratio  $C$  is therefore

$$C = C_0 * \frac{L_c}{L_{g,im}} \quad (3)$$

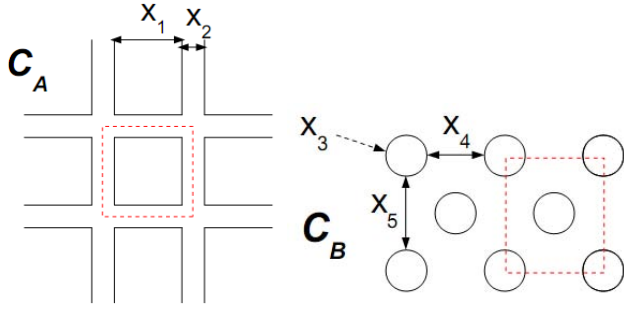

Figure 3 : Illustration of the two patterns  $C_A$  and  $C_B$  used to materialize clogging with their characteristic dimensions. The red dashed rectangle represents the basic pattern. Their  $C_0$  ratios are respectively 44% and 64%.

Six different configurations of clogging were tested from plates with two different hole patterns, noted  $C_A$  and  $C_B$  in Figure 3:

- configuration C1 : clogging on the whole rack with a  $C_A$  plate ( $x_1=30$  mm;  $x_2=10$  mm)
- configuration C2 : clogging on the whole rack with a  $C_A$  plate ( $x_1=15$  mm;  $x_2=5$  mm)
- configuration C3 : clogging on the whole rack with a  $C_B$  plate ( $x_3=5$  mm;  $x_4=3$  mm;  $x_5=8.85$  mm)
- configuration C4 : clogging on the upper and lower parts of the rack with two  $C_B$  plates ( $x_3=5$  mm;  $x_4=3$  mm;  $x_5=8.85$  mm) covering respectively 14 and 11 cm of the rack length.
- configuration C5 : clogging on the upper part of the rack with a  $C_B$  plate ( $x_3=5$  mm;  $x_4=3$  mm;  $x_5=8.85$  mm) covering 14 cm of the rack length
- configuration C6 : clogging on the lower part of the rack with a  $C_B$  plate ( $x_3=5$  mm;  $x_4=3$  mm;  $x_5=8.85$  mm) covering 11 cm of the rack length

These plates were positioned on inclined rack with notably two main inclinations:  $\beta=90^\circ$  for vertical trashracks and  $\beta=25^\circ$  for fish-friendly configurations.

### Head loss formulae for clean inclined trashracks

Before making experiments on each configuration, preliminary tests were carried out. Their goal was to check the constancy of  $\xi$  for different trashracks from those with low Reynolds number ( $Re$ ) and high Froude number ( $Fr$ ) ( $Re$  and  $Fr$  defined in Eq. 4) which accounts for this study to those with higher  $Re$  and slightly lower  $Fr$  commonly found in real hydroelectric installations.

$$Re = \frac{V_1 * b}{\nu} \quad ; \quad Fr = \frac{V_1}{\sqrt{g * H_1}} \quad (4)$$

Thus, changing parameters such as the upstream water depth or the bar width, the applicability of the results of this study on real water intake has been checked.

The experiments carried out for this study allowed to draw the evolution of  $\xi$  with the inclination  $\beta$ . These experimental results were divided into two parts.

The first step is the comparison between measured head loss coefficients and coefficients calculated with formulae found in the literature, most of which may only be applied to vertical trashracks. The best results were obtained using formulae which take into account the global blocking ratio  $O$  (and not only the effect of bars) and which keep a realistic boundary condition on  $O$  ( $\xi$  tends to infinite when  $O$  tends to 1). However, no formula gave good prediction for the head loss coefficient of a trashrack equipped with close hydrodynamic bars (Raynal et al. 2012).

The second step is comparing the effect of the inclination. The few formulae which consider this parameter always describe this effect as a decrease in  $\sin(\beta)$ , which was initially proposed by Kirschmer (1926). At low inclination (high  $\beta$ ), the decrease of  $\xi$  seems to be steeper than a sinusoidal shape. At high inclination (low  $\beta$ ), the declining trend of  $\xi$  is attenuated and  $\xi$  even tends to increase in some configuration between  $25^\circ$  and  $15^\circ$ . This may be explained by the low effect of bars and the increasing number of spacer rows. Consequently, this behavior cannot be described by a sine shape (Raynal et al. 2012).

This is the reason why a new head loss formula was proposed (Eq. 5), in which the contribution of horizontal elements is separated from that of vertical elements.

$$\xi = A_i * \left( \frac{O_b}{1 - O_b} \right)^{1.65} * \sin^2(\beta) + 1.79 * \left( \frac{O_{sp,H}}{1 - O_{sp,H}} \right)^{0.77} \quad (5)$$

The parameter  $A_i$  depends on the bar shape. Its values are  $A_{PR}=3.85$  and  $A_{PH}=2.10$ .

Figure 4 superimposes measured coefficients with coefficients calculated with Eq. 5. This formula gives relevant results and well describes both the behavior at low inclination and the changes at low  $\beta$ . However it also raises some questions. The coefficient “1.79” is very close to the shape coefficient  $K_F$  of a cylinder (which is the spacer shape) given by Kirschmer (1928). As a result, on real water intakes, the value of this coefficient should certainly be adapted, according to the shape of spacers rows and horizontal supports, which are often rectangular and I beams. Nonetheless, the  $A_i$  coefficients seem to have higher values than their relative shape coefficient (2.42 for PR and about 1.03 for PH in Kirschmer, 1928). This may be explained by the fact that close bars interfere one on each other whereas spacer rows are distant enough to avoid this issue. This means that knowing if trashrack elements have

mutual influence or not is an important prerequisite for the analysis of experimental results.

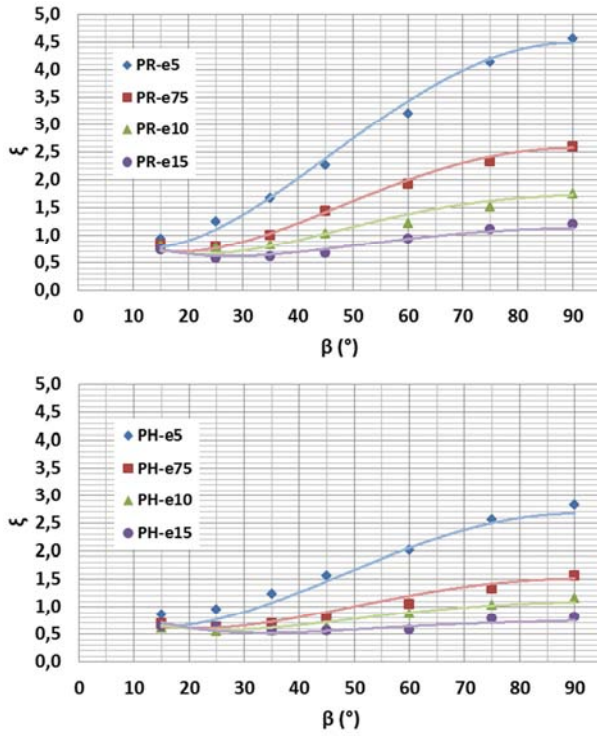

Figure 4 : Comparison of measured (marks) and calculated (with Eq. 5 - lines) head loss coefficients for rectangular (top) and hydrodynamic (bottom) bar section. Each color represents one space between bars (e75=7.5mm).

### Clogging influence on head losses

#### Head loss increase

In order to assess the influence of clogging on head losses, the head loss coefficient of clogged racks is decomposed into two variables (Eq. 6):  $\xi_{clean}$  which is the head loss for a clean rack, calculated with Eq. 5 or extracted from measurements, and  $K_C$  which is the increase factor due to clogging.

$$\xi = \xi_{clean} * K_C \quad (6)$$

Measuring  $\xi$  and dividing it by  $\xi_{clean}$  provided us experimental values for  $K_C$ . Figure 5 and Figure 6 show the same evolution of  $K_C$  with the  $C$  ratio, but in two different ways. Figure 5 highlights the influence of trashrack configurations whereas Figure 6 illustrates the influence of clogging configurations.

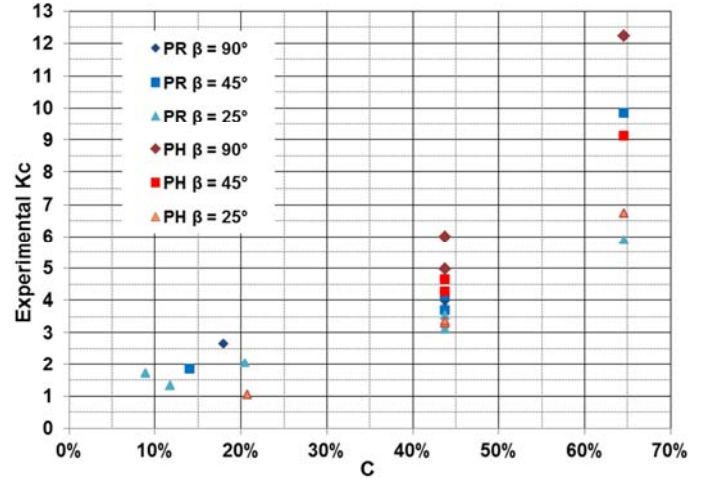

Figure 5 : Comparison of  $K_C$  with  $C$  for different trashrack configurations (PR or PH ;  $\beta=25^\circ, 45^\circ$  or  $90^\circ$ ). PR and PH racks are respectively in red or blue shades. The mark shape represents the inclination.

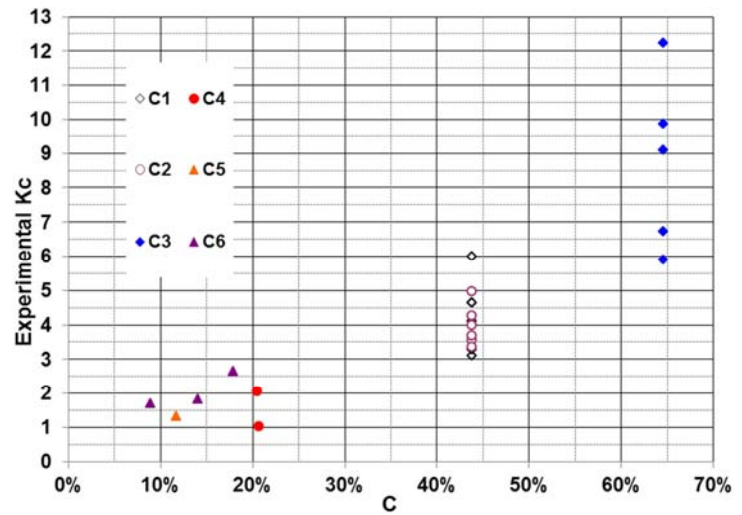

Figure 6 : Comparison of  $K_C$  with  $C$  for different clogging configurations.

Both Figure 5 and Figure 6 illustrate the increase of  $K_C$  with  $C$ . Indeed, for the same trashrack, the value at  $C=64\%$  is twice the value at  $C=44\%$ . However, for a unique  $C$  ratio,  $K_C$  may vary according to the trashrack configuration or the clogging type.

On Figure 5, red symbols, accounting for PH racks, lead generally to higher  $K_C$  than blue ones (PR racks), except for two cases. As clogged grids generate more disturbed flows, these two exceptions may be explained by the higher uncertainties on downstream water depths. However, differences between PR and PH racks never exceed 25%. Then, focusing on symbol shapes, it also seems that  $K_C$  for  $\beta=90^\circ$  (diamonds) is higher than for  $\beta=25^\circ$  (triangles). On clean racks, the inclination makes the bar effect decreases. The same observation is made for the clogging influence which gets lower with the inclination.

On Figure 6, configuration C1 and C2, which are made with different plates but with identical clogging ratio  $C$ , generate similar clogging effect with close  $K_C$  values.

In summary,  $\beta$  and  $C$  are the most influent parameters on  $K_C$ . To a lesser extent, the bar shape also leads to different  $K_C$ . On the contrary, the clogging type should not be taken into account to calculate  $K_C$ . This is coherent with Meusburger's observations (2002). He carried out head loss measurement on clogged trashracks ( $C \leq 25\%$ ) which had no inclination or orientation. He managed to obtain a formula (Eq. 7) which suited in 14 out of its 16 clogging configuration tested.

$$K_{C,Meus,2} = 1 + 1.8 * O^{-1.2} * \left(\frac{C}{1-C}\right)^{1.2} \quad (7)$$

However, this formula only takes into account the blockage ratio  $O$  and the clogging ratio  $C$ , assuming that the influence of other parameters (bar shape, trashrack angle...) does not modify the value of  $K_C$ . Our observations showed that this cannot be sufficient and that the inclination should appear in the formula. Nonetheless, Eq. 7 was tested on our experimental  $K_C$  values at  $\beta=90^\circ$  (Figure 7) and led to satisfactory results, with predicted  $K_C$  values which are mainly between  $\pm 30\%$  of experimental ones. This means that Eq. 7 may be used at least until  $C=65\%$  for vertical trashracks.

Then, Eq. 7 was also tested on inclined configuration and gave predicted  $K_C$  values which were much different from measured ones. In fish-friendly configuration ( $\beta=25^\circ$ ), many experimental points were overestimated by more than 50%.

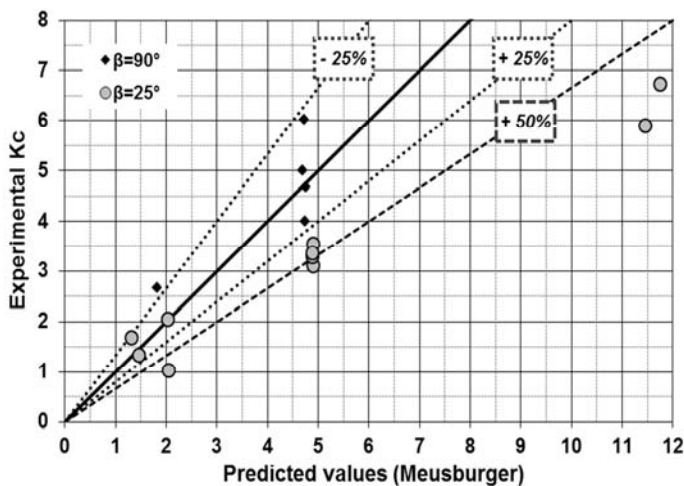

Figure 7 : Comparison between experimental  $K_C$  values and those predicted by Meusburger (2002) with Eq. 7.

Instead of inspiring from Meusburger's formula and extending it to inclined trashracks, the Eq. 5 was adapted to take into account clogging. This means that the separated

term  $K_C$  does no longer appear literally in the expression of  $\xi$ , but may be still used to discuss clogging effects. As the effect of clogging on head losses is mainly due to the inclination  $\beta$  and the clogging ratio  $C$ , the blockage ratio due to bars  $O_b$ , which is also subject to the inclination, was replaced by a new term  $O_{b,C}$  (Eq.8). All the clogging effect is now contained in  $O_{b,C}$ , meaning that the additional blockage due to clogging may be interpreted as an increase of the bar number.

$$O_{b,C} = O_b + (1 - O_b) * C \quad (8)$$

Replacing  $O_b$  by  $O_{b,C}$  leads to Eq. 9. Then, to compare with experimental and Meusburger's result, the clogging effect represented by  $K_C$ , is obtained by the Eq. 10.

$$\xi = A_i * \left(\frac{O_{b,C}}{1 - O_{b,C}}\right)^{1.65} * \sin^2(\beta) + 1.79 * \left(\frac{O_{sp,H}}{1 - O_{sp,H}}\right)^{0.77} \quad (9)$$

$$K_C = \frac{A_i * \left(\frac{O_{b,C}}{1 - O_{b,C}}\right)^{1.65} * \sin^2(\beta) + 1.79 * \left(\frac{O_{sp,H}}{1 - O_{sp,H}}\right)^{0.77}}{A_i * \left(\frac{O_b}{1 - O_b}\right)^{1.65} * \sin^2(\beta) + 1.79 * \left(\frac{O_{sp,H}}{1 - O_{sp,H}}\right)^{0.77}} \quad (10)$$

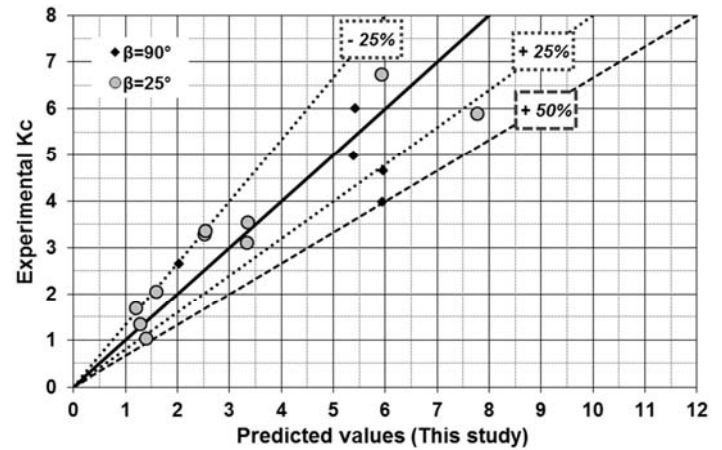

Figure 8 : Comparison between experimental  $K_C$  values and those predicted by Eq. 10 in this study.

For vertical racks, Eq. 10 and Eq. 7 give comparable results, but Meusburger's ones (Eq. 7) are slightly more accurate. For fish-friendly racks inclined at  $25^\circ$ , results are much better for Eq. 10 for which most predicted points are contained between  $\pm 25\%$  of the experimental value.

Including the clogging ratio in the blockage ratio due to bars seems to provide a rather good estimation of head loss coefficients for either vertical or inclined trashracks. The resulting predicted coefficients may sometimes differ from experimental ones by 25% but this precision may be acceptable for applications on real water intakes. Indeed, as the clogging ratio cannot be precisely calculated on immersed trashracks in operation, a more elaborate formula may not bring any improvement for real applications.

## Conclusion

Head losses due to trashracks with small bar spacing were experimentally characterized from vertical to highly inclined and fish-friendly configurations. As small bar spacing increase the rack clogging, which is a topic of interest for hydro power plant operation, the effect of clogging on head losses was also investigated.

Trashrack bar spacing, shape and inclination are the main influent parameters on head losses. As existing formulae do not correctly estimate head loss coefficient, especially at high inclination, a new head loss formula is proposed, in which the blockage ratio due to horizontal elements (spacer rows)  $O_{sp,H}$  is separated from that of vertical elements (bars)  $O_b$ .

Experimental results show that the clogging effect logically depends on the clogging ratio, but also on the trashrack configuration, i.e. its inclination. To a lesser extent, the bar shape has also an influence. On the contrary, the clogging type is not significantly influent. A simple adaptation of the formula proposed for clean trashracks, which aims at taking into account the clogging effect, is suggested. Assuming that bars and clogging have similar influence, the clogging ratio  $C$  is added into the variable representing the blockage ratio due to bars  $O_b$ . This gives results coherent with Meusbürger's ones for vertical trashracks, and improves the prediction quality for inclined racks.

In conclusion, this study allowed proposing a formula to estimate trashrack head loss coefficients, fully applicable to fish-friendly configurations never studied in previous researches, and able to take into account the clogging effect.

## Acknowledgements

This work is funded by the FEDER, the Région Poitou Charentes, ONEMA, ADEME, CNR, SHEM and France HYDRO-Electricité. Their supports are greatly acknowledged.

## Notation

$A_{PR}, A_{PH}$	Coefficient in the head loss equation for inclined grid
$b$	Bar width
$C$	Clogging ratio
$C_0$	Blocking ratio of perforated plates
$C1...C6$	Number for clogging configuration
$C_A, C_B$	Denomination for the perforated plate patterns
$D_{sp}$	Spacer diameter
$e$	Space between two bars
$Fr$	Froude number
$g$	Gravitational acceleration
$H_1, H_2$	Upstream and downstream water depths
$K_C$	Increase of $\xi$ due to clogging
$K_{C,Meus.2}$	Formula for the head loss coefficient due to clogging proposed by Meusbürger
$K_F$	Form coefficient
$L_g, L_{g,im}$	Total and immersed trashrack lengths

$N_b$	Number of bars
$N_{sp,im}$	Number of immersed spacers rows
$O$	Blockage ratio
$O_b$	Blockage ratio due to bars and lateral supports
$O_{b,C}$	Blockage ratio due to bars, lateral supports and clogging
$O_{sp}, O_{sp,H}$	Blockage ratio due to transversal elements reported on the trashrack length or reported on the upstream water depth
$p$	Bar depth
$PR, PH$	Bar shape denomination (rectangular and hydrodynamic)
$Q$	Flow rate
$Re$	Reynolds number
$V_1, V_2$	Upstream and downstream mean velocities
$x, y, z$	Streamwise, transversal and vertical coordinates
$x_1...x_5$	Characteristic dimension for $C_A$ and $C_B$ patterns
$\beta$	Trashrack inclination
$\Delta H_0, \Delta H$	Head loss due to the channel and head loss due to the grid
$\lambda$	Laser wavelength
$\nu$	Kinematic viscosity
$\xi$	Trashrack head loss coefficient
$\xi_{clean}$	Trashrack head loss coefficient for clean trashracks

## References

- Clark, S. & Tsitaka, J. (2009), 'Effects of blockage ratio on energy loss through rectangular bar trashracks for hydro-turbines. 33rd IAHR Congress: Water Engineering for a Sustainable Environment'.
- Courret, D. & Larinier, M. (2008), 'Guide pour la conception de prises d'eau "ichtyocompatibles" pour les petites centrales hydroélectriques', Agence De l'Environnement et de la Maîtrise de l'Energie (ADEME). ([www.onema.fr/IMG/pdf/2008\\_027.pdf](http://www.onema.fr/IMG/pdf/2008_027.pdf)).
- EPRI, (2001), 'Review and documentation of research and technologies on passage and protection of downstream migrating catadromous eels at hydroelectric facilities'. Report, Electric Power Research Institute (EPRI), Palo Alto, CA. 1000730, 73 p.
- EPRI, (2002), 'Upstream and Downstream Fish Passage and Protection Technologies for Hydroelectric Application: A Fish Passage and Protection Manual, EPRI, Palo Alto, CA: 2002. 1005392.
- Gomes, P. & Larinier, M. (2008), 'Dommages subis par les anguilles lors de leur passage au travers des turbines Kaplan – Etablissement de formules prédictives'. Rapport GHAAPPE RA08.05. Programme national de recherche-développement Anguilles-Ouvrages. 76 p.
- Kirschmer, O. (1926), 'Untersuchungen uber den Gefallverlust an Rechen', Mitt. Hydr. Inst., Munich.
- Larinier, M. & Travade, F. (2002), 'Downstream migration: problems and facilities'. *Bull. Fr. Pêche Piscic.* (2002) 364 suppl.: 181-207.
- Meusbürger, H. (2002), 'Energieverluste an einlaufrechen von flusskraftwerken', PhD thesis, Bau-Ing., ETH-Zürich. (<http://e-collection.library.ethz.ch/view/eth:26261>)
- Monten, E. (1985), 'Fish and turbines. Fish injuries during passage through power station turbines'. Vattenfall, Stockholm: 111p.
- Osborn, J. (1968), 'Rectangular-bar trashrack and baffle headlosses', *Journal of the Power Division* 94, No. PO2, 111-123.
- Raynal, S., Courret, D., Chatellier, L., Larinier, M. & David, L. (2012), 'An experimental study in fish-friendly trashracks – Part 1 : Inclined trashracks', submitted in *Journal of Hydraulic Research*.
- Travade, F., Larinier, M., Subra, S., Gomes P. & De-Oliveira, E. (2010), 'Behaviour and passage of European silver eels (*Anguilla anguilla*) at a small hydropower plant during their downstream migration'. *Knowledge and Management of Aquatic Ecosystems* (2010) 398, 01.