



**HAL**  
open science

## **Kinematic Synthesis and Analysis of the RoboMech Class Parallel Manipulator with Two Grippers**

Zhumadil Baigunchekov, Med Amine Laribi, Azamat Mustafa, Abzal Kassinov

► **To cite this version:**

Zhumadil Baigunchekov, Med Amine Laribi, Azamat Mustafa, Abzal Kassinov. Kinematic Synthesis and Analysis of the RoboMech Class Parallel Manipulator with Two Grippers. *Robotics*, 2021, 10 (3), pp.99. 10.3390/robotics10030099 . hal-04086598

**HAL Id: hal-04086598**

**<https://hal.science/hal-04086598>**

Submitted on 2 May 2023

**HAL** is a multi-disciplinary open access archive for the deposit and dissemination of scientific research documents, whether they are published or not. The documents may come from teaching and research institutions in France or abroad, or from public or private research centers.

L'archive ouverte pluridisciplinaire **HAL**, est destinée au dépôt et à la diffusion de documents scientifiques de niveau recherche, publiés ou non, émanant des établissements d'enseignement et de recherche français ou étrangers, des laboratoires publics ou privés.

Article

# Kinematic Synthesis and Analysis of the RoboMech Class Parallel Manipulator with Two Grippers

Zhumadil Baigunchekov <sup>1,2</sup>, Med Amine Laribi <sup>3,\*</sup> , Azamat Mustafa <sup>2,\*</sup> and Abzal Kassinov <sup>1</sup>

<sup>1</sup> Department of Mechanics, Al-Farabi Kazakh National University, 71 Al-Farabi Ave., Almaty 050040, Kazakhstan; bzh47@mail.ru (Z.B.); kassinov07@gmail.com (A.K.)

<sup>2</sup> Department of Mechanical Engineering and Modeling, Satbayev University, 22a Satpaev Str., Almaty 050013, Kazakhstan

<sup>3</sup> Department GMSC, Institut PPRIME, CNRS, Université de Poitiers, ENSMA, UPR 3346, 86962 Poitiers, France

\* Correspondence: med.amine.laribi@univ-poitiers.fr (M.A.L.); mustafa\_azamat@mail.ru (A.M.)

**Abstract:** In this paper, methods of kinematic synthesis and analysis of the RoboMech class parallel manipulator (PM) with two grippers (end effectors) are presented. This PM is formed by connecting two output objects (grippers) with a base using two passive and one negative closing kinematic chains (CKCs). A PM with two end effectors can be used for reloading operations of stamped products between two adjacent main technologies in a cold stamping line. Passive CKCs represent two serial manipulators with two degrees of freedom, and negative CKC is a three-joined link with three negative degrees of freedom. A negative CKC imposes three geometric constraints on the movements of the two output objects. Geometric parameters of the negative CKC are determined on the basis of the problems of the Chebyshev and least-square approximations. Problems of positions and analogues of velocities and accelerations of the PM with two end effectors have been solved.

**Keywords:** parallel manipulator; RoboMech; kinematic synthesis and analysis; Chebyshev and least-square approximations



**Citation:** Baigunchekov, Z.; Laribi, M.A.; Mustafa, A.; Kassinov, A. Kinematic Synthesis and Analysis of the RoboMech Class Parallel Manipulator with Two Grippers. *Robotics* **2021**, *10*, 99. <https://doi.org/10.3390/robotics10030099>

Academic Editor: Raffaele Di Gregorio

Received: 12 June 2021

Accepted: 30 July 2021

Published: 3 August 2021

**Publisher's Note:** MDPI stays neutral with regard to jurisdictional claims in published maps and institutional affiliations.



**Copyright:** © 2021 by the authors. Licensee MDPI, Basel, Switzerland. This article is an open access article distributed under the terms and conditions of the Creative Commons Attribution (CC BY) license (<https://creativecommons.org/licenses/by/4.0/>).

## 1. Introduction

There are technological processes in industry where it is necessary to perform several operations simultaneously or sequentially, for example, in stamping production, in loading and unloading operations. For the simultaneous or sequential execution of several operations, it is advisable to use manipulation robots with many end effectors.

In this paper, a PM with two end effectors is synthesized that can be used to perform reloading operations from one technological equipment to another. This PM with two end effectors replaces two industrial serial robots in the existing production line of cold stamping and it belongs to the RoboMech class PM. The PM, simultaneously setting the laws of motions of the end effectors and actuators, is called the RoboMech class PM [1]. Setting the laws of motion of the actuators monotonously and uniformly but not defining by solving the inverse kinematics problem simplifies the control system and improves dynamics. Replacing two industrial robots with one RoboMech class PM with two end effectors simplifies the control system and increases the productivity and reliability of the technological line.

Since in the RoboMech class PMs simultaneously set the laws of motion of the end effectors and actuators, they work with certain structural schemes and geometric parameters of their links. The existing methods of kinematic analysis and synthesis of mechanisms and manipulators are based on the derivation of loop-closure equations and their study: in kinematic analysis, using known constant geometric parameters of links and variable generalized coordinates, variable parameters characterizing the relative movements of elements of kinematic pairs are determined, and in kinematic synthesis (dimensional or

parametric synthesis) for the given positions of the input and output links, constant geometric parameters of the links are determined. Loop-closure equations are derived on the base of vector and matrix methods [2–10], and the theory of screws [11–13], which are leads to polynomials of higher degrees. Then, examining the resulting polynomials using computers, depending on the assigned tasks, the kinematic analysis or synthesis is performed. McCarthy in his papers [14,15] shows the close relationship between the kinematics, synthesis, polynomials, and computations in the 21st century. In the considered approach of kinematic analysis and synthesis of mechanisms and manipulators, it is rather difficult to obtain the polynomials; moreover, with the complication of the structures of mechanisms and manipulators, the formation of polynomials becomes more complicated and their degree increases. Performance analysis and applications of the PMs and robots are also presented in [16–21].

In this paper, kinematic synthesis of the PM with two end effectors is carried out on the basis of a modular approach [22,23], according to which PMs, regardless of their complexity, are formed by connecting the output objects (end effectors) with a base using closing kinematic chains (CKCs), which are structural modules. CKCs can be active, passive, and negative, which have positive, zero, and negative DOFs, respectively. The active and negative CKCs impose geometric constraints on the motions of the output objects, and passive CKCs do not impose geometric constraints. The representation of PMs from separate structural modules simplifies the methods of their investigation.

## 2. Kinematic Synthesis of the PM with Two Grippers

A PM with two end effectors can be used in a cold stamping technological line for reloading operations between two hydraulic presses [24].

Figure 1 shows a structural scheme of the PM with two end effectors in two positions.

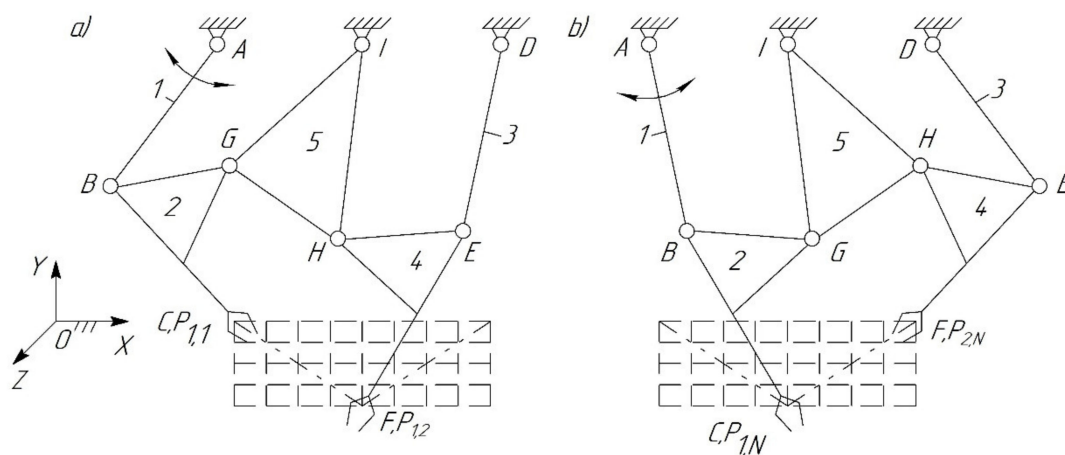

**Figure 1.** PM with two end effectors in two positions: (a) the first position (b) the second position.

In the first position (Figure 1a), the first gripper  $P_1$  in position  $P_{1,1}$  takes the workpiece after processing in the first hydraulic press for delivery to the store. At this time, the second gripper  $P_2$  in position  $P_{2,1}$  takes the previous workpiece processed in the first hydraulic press for delivery to the second hydraulic press for further processing.

In the second position (Figure 1b), the first gripper  $P_1$  in position  $P_{1,N}$  delivers the workpiece to the store and the second gripper  $P_2$  in position  $P_{2,N}$  delivers the previous workpiece to the second hydraulic press. The cycle is then repeated.

The considered positioning PM with two end effectors is formed by connecting two output objects (grippers  $P_1$  and  $P_2$ ) with a base using two passive and one negative CKC in the following sequence. First, the grippers  $P_1$  and  $P_2$  are connected to the base using passive CKCs  $ABC$  and  $DEF$  with revolute kinematic pairs, respectively, which have two degrees of freedom. Since passive CKCs  $ABC$  and  $DEF$  have two degrees of freedom, they

can reproduce the given laws of motion of the output points  $P_1$  and  $P_2$ . Then, to form a single movable PM with two end effectors, we connect the links  $BC$  and  $EF$  of the passive CKCs  $ABC$  and  $DEF$  with the base using a negative CKC  $GHI$  with three negative degrees of freedom. Figure 2 shows a block structure of the formed PM with two end effectors.

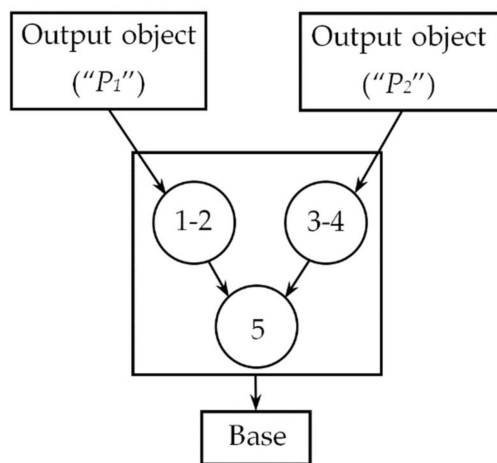

Figure 2. Block structure of the PM with two end effectors.

According to the block structure (Figure 2), the parametric synthesis of the PM with two end effectors (Figure 3) consists of the parametric synthesis of two passive CKCs— $ABC$  and  $DEF$ —and one negative CKC— $GHI$ . The parameters of the synthesis of two passive CKCs— $ABC$  and  $DEF$ —are  $X_A, Z_A, l_{AB}, l_{BC}$  and  $X_D, Z_D, l_{DE}, l_{EF}$ , respectively, where  $X_A, Z_A$  and  $X_D, Z_D$  are the coordinates of the fixed joints  $A$  and  $D$  in the absolute coordinate system  $OXYZ$ ;  $l_{AB}, l_{BC}, l_{DE}, l_{EF}$  are the length of the links  $AB, BC, DE, EF$ . Let denote these parameters by the vectors  $\mathbf{p}_1$  and  $\mathbf{p}_2$ , where  $\mathbf{p}_1 = [X_A, Z_A, l_{AB}, l_{BC}]^T$  and  $\mathbf{p}_2 = [X_D, Z_D, l_{DE}, l_{EF}]^T$ .

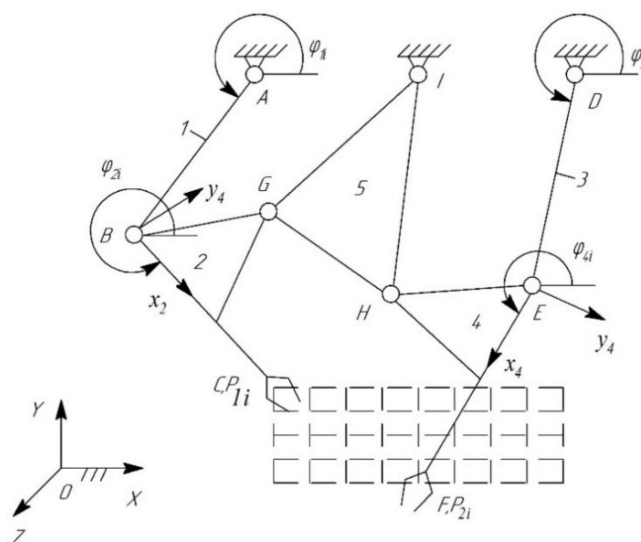

Figure 3. PM with two end effectors in the first position.

Since the passive CKCs do not impose geometric constraints on the movements of the output points  $C$  and  $F$ , the vectors of the synthesis parameters  $\mathbf{p}_1$  and  $\mathbf{p}_2$  are varied by the

generator of  $LP_\tau$  sequence [25] to satisfy the constraints of the negative CKC *IDH*. In this case, the following conditions should be fulfilled:

$$|l_{AB} - l_{BC}| \leq \rho_{1\min}, \quad l_{AB} + l_{BC} \geq \rho_{1\max}, \quad (1)$$

$$|l_{DE} - l_{EF}| \leq \rho_{2\min}, \quad l_{DE} + l_{EF} \geq \rho_{2\max}, \quad (2)$$

where:

$$\rho_{1\min} = \min_{X_{P_1}, Y_{P_1}} |l_{AP_{1i}}|, \quad \rho_{1\max} = \max_{X_{P_1}, Y_{P_1}} |l_{AP_{1i}}|, \quad (3)$$

$$\rho_{2\min} = \min_{X_{P_2}, Y_{P_2}} |l_{DP_{2i}}|, \quad \rho_{2\max} = \max_{X_{P_2}, Y_{P_2}} |l_{DP_{2i}}|. \quad (4)$$

The variable distances  $l_{AP_{1i}}$  and  $l_{CP_{2i}}$  in the Expressions (1)–(4) are determined by the equations:

$$l_{AP_{1i}} = \left[ (X_{P_{1i}} - X_A)^2 + (Y_{P_{1i}} - Y_A)^2 \right]^{\frac{1}{2}}, (i = 1, 2, \dots, N), \quad (5)$$

$$l_{DP_{2i}} = \left[ (X_{P_{2i}} - X_D)^2 + (Y_{P_{2i}} - Y_D)^2 \right]^{\frac{1}{2}}. \quad (6)$$

Let us consider the parametric synthesis of the negative CKC *GHI* with three negative degrees of freedom, determined by the Chebyshev formula [26]:

$$W = 3n - 2p_5 = 3 \cdot 1 - 2 \cdot 3 = -3, \quad (7)$$

where  $n$  is number of links,  $p_5$  is the kinematic pairs of the fifth class.

To do this, we preliminarily determine the positions of links 2 and 4 of the passive CKCs *ABC* and *DEF* by the equations:

$$\varphi_{2i} = \text{tg}^{-1} \frac{Z_{P_{1i}} - Z_{B_i}}{X_{P_{1i}} - X_{B_i}}, \quad (8)$$

$$\varphi_{4i} = \text{tg}^{-1} \frac{Z_{P_{2i}} - Z_{E_i}}{X_{P_{2i}} - X_{E_i}}, \quad (9)$$

where:

$$\begin{bmatrix} X_{B_i} \\ Z_{B_i} \end{bmatrix} = \begin{bmatrix} X_A \\ Z_A \end{bmatrix} + l_{AB} \begin{bmatrix} \cos \varphi_{1i} \\ \sin \varphi_{1i} \end{bmatrix}, \quad (10)$$

$$\begin{bmatrix} X_{E_i} \\ Z_{E_i} \end{bmatrix} = \begin{bmatrix} X_D \\ Z_D \end{bmatrix} + l_{DE} \begin{bmatrix} \cos \varphi_{3i} \\ \sin \varphi_{3i} \end{bmatrix}, \quad (11)$$

$$\varphi_{1i} = \varphi_{AP_{1i}} - \cos^{-1} \frac{l_{AB}^2 + l_{AP_{1i}}^2 - l_{BC}^2}{2l_{AB}l_{AP_{1i}}}, \quad (12)$$

$$\varphi_{3i} = \varphi_{DP_{2i}} + \cos^{-1} \frac{l_{DE}^2 + l_{DP_{2i}}^2 - l_{EF}^2}{2l_{DE}l_{DP_{2i}}}, \quad (13)$$

$$\varphi_{AP_{1i}} = \text{tg}^{-1} \frac{Z_{P_{1i}} - Z_A}{X_{P_{1i}} - X_A}, \quad (14)$$

$$\varphi_{DP_{2i}} = \text{tg}^{-1} \frac{Z_{P_{2i}} - Z_D}{X_{P_{2i}} - X_D}. \quad (15)$$

Let us attach the coordinate systems  $Bx_2z_2$  and  $Ex_4z_4$  with the links *BC* and *EF* of the passive CKCs *ABC* and *DEF*, where the axes  $Bx_2$  and  $Ex_4$  are directed along the links *BC* and *EF*, respectively (Figure 3). Then, the synthesis parameters of the negative CKC *GHI* are  $x_G^{(2)}, z_G^{(2)}, x_H^{(4)}, z_H^{(4)}, l_{GH}, X_I, Z_I, l_{GI}, l_{HI}$  where  $x_G^{(2)}, z_G^{(2)}, x_H^{(4)}, z_H^{(4)}, X_I, Z_I$  are the coordinates of the joints *G, H, I* in the coordinate systems  $Bx_2z_2, Dx_4z_4, OXYZ$ , respectively;

$l_{GH}, l_{GI}, l_{HI}$  are the lengths of the sides  $GH, GI, HI$  of the link  $GHI$ . Let us denote these synthesis parameters through the vector  $\mathbf{p}_3 = [x_G^{(2)}, z_G^{(2)}, x_H^{(4)}, z_H^{(4)}, l_{GH}, X_I, Z_I, l_{GI}, l_{HI}]$ .

Since the three-joined link  $GHI$  imposes three geometric constraints on the movements of the links of two passive CKCs  $ABC$  and  $DEF$ , we derive three functions of weighted differences:

$$\Delta q_{1i} = (x_{Hi}^{(2)} - x_G^{(2)})^2 + (z_{Hi}^{(2)} - z_G^{(2)})^2 - l_{HG}^2, \tag{16}$$

$$\Delta q_{2i} = (X_{Gi} - X_I)^2 + (Z_{Gi} - Z_I)^2 - l_{GI}^2, \tag{17}$$

$$\Delta q_{3i} = (X_{Hi} - X_I)^2 + (Z_{Hi} - Z_I)^2 - l_{HI}^2, \tag{18}$$

where  $x_{Hi}^{(2)}$  and  $z_{Hi}^{(2)}$  are the coordinates of the joint  $H$  in the local coordinate system  $Bx_2z_2$ ;  $Z_{Gi}, X_{Gi}$  and  $X_{Hi}, Z_{Hi}$  are the coordinates of the joints  $G$  and  $H$  in the absolute coordinate system  $OXYZ$ , which are determined by the equations:

$$\begin{bmatrix} x_{Hi}^{(2)} \\ z_{Hi}^{(2)} \end{bmatrix} = \begin{bmatrix} \cos \varphi_{2i} & \sin \varphi_{2i} \\ -\sin \varphi_{2i} & \cos \varphi_{2i} \end{bmatrix} \cdot \begin{bmatrix} X_{Hi} - X_{Bi} \\ Z_{Hi} - Z_{Bi} \end{bmatrix}, \tag{19}$$

$$\begin{bmatrix} X_{Gi} \\ Z_{Gi} \end{bmatrix} = \begin{bmatrix} X_{Bi} \\ Z_{Bi} \end{bmatrix} + \begin{bmatrix} \cos \varphi_{2i} & -\sin \varphi_{2i} \\ \sin \varphi_{2i} & \cos \varphi_{2i} \end{bmatrix} \cdot \begin{bmatrix} x_G^{(2)} \\ z_G^{(2)} \end{bmatrix}, \tag{20}$$

$$\begin{bmatrix} X_{Hi} \\ Z_{Hi} \end{bmatrix} = \begin{bmatrix} X_{Ei} \\ Z_{Ei} \end{bmatrix} + \begin{bmatrix} \cos \varphi_{4i} & -\sin \varphi_{4i} \\ \sin \varphi_{4i} & \cos \varphi_{4i} \end{bmatrix} \cdot \begin{bmatrix} x_H^{(4)} \\ z_H^{(4)} \end{bmatrix}, \tag{21}$$

where:

$$\begin{bmatrix} X_{Bi} \\ Z_{Bi} \end{bmatrix} = \begin{bmatrix} X_A \\ Z_A \end{bmatrix} + l_{AB} \begin{bmatrix} \cos \varphi_{1i} \\ \sin \varphi_{1i} \end{bmatrix}, \tag{22}$$

$$\begin{bmatrix} X_{Ei} \\ Z_{Ei} \end{bmatrix} = \begin{bmatrix} X_D \\ Z_D \end{bmatrix} + l_{DE} \begin{bmatrix} \cos \varphi_{3i} \\ \sin \varphi_{3i} \end{bmatrix}. \tag{23}$$

The geometric meanings of Functions (16)–(18) are the deviations of the coordinates of the joints  $H$  and  $G$  from circles with radiuses  $l_{HG}, l_{GI}, l_{HI}$  in the relative motion of the plane  $Ex_4z_4$  and in the absolute motion of link 5.

After replacing the synthesis parameters of the form:

$$\begin{aligned} \begin{bmatrix} p_1 \\ p_2 \end{bmatrix} &= \begin{bmatrix} x_G^{(2)} \\ y_G^{(2)} \end{bmatrix}, \begin{bmatrix} p_4 \\ p_5 \end{bmatrix} = \begin{bmatrix} x_H^{(4)} \\ y_H^{(4)} \end{bmatrix}, \\ p_3 &= \frac{1}{2}(x_G^{(2)2} + z_G^{(2)2} + x_H^{(4)2} + z_H^{(4)2} - l_{GH}^2), \\ \begin{bmatrix} p_6 \\ p_7 \end{bmatrix} &= \begin{bmatrix} X_I \\ Z_I \end{bmatrix}, p_8 = \frac{1}{2}(x_G^{(2)2} + z_G^{(2)2} + X_I^2 + Z_I^2 - l_{GI}^2), \\ p_9 &= \frac{1}{2}(x_H^{(4)2} + z_H^{(4)2} + X_I^2 + Z_I^2 - l_{HI}^2) \end{aligned} \tag{24}$$

Functions (16)–(18) are expressed linearly in the following vectors of synthesis parameters  $\mathbf{p}_3^{(1)} = [p_1, p_2, p_3]^T, \mathbf{p}_3^{(2)} = [p_4, p_5, p_3]^T, \mathbf{p}_3^{(3)} = [p_6, p_7, p_8]^T, \mathbf{p}_3^{(4)} = [p_1, p_2, p_8]^T, \mathbf{p}_3^{(5)} = [p_6, p_7, p_9]^T, \mathbf{p}_3^{(6)} = [p_4, p_5, p_9]^T$  as:

$$\Delta q_{1i}^{(k)} = 2(\mathbf{g}_{1i}^{(k)T} \cdot \mathbf{p}_3^{(k)} - g_{0i}^{(k)}), k = 1, 2, \tag{25}$$

$$\Delta q_{2i}^{(k)} = 2(\mathbf{g}_{2i}^{(k)T} \cdot \mathbf{p}_3^{(k)} - g_{0i}^{(k)}), k = 3, 4, \tag{26}$$

$$\Delta q_{3i}^{(k)} = 2(\mathbf{g}_{3i}^{(k)T} \cdot \mathbf{p}_3^{(k)} - g_{0i}^{(k)}), k = 5, 6, \tag{27}$$

where:

$$\mathbf{g}_{1i}^{(1)} = - \begin{bmatrix} \Gamma^{-1}(\varphi_{2i}) & 0 \\ 0 & 0 & 1 \end{bmatrix} \cdot \begin{bmatrix} X_{Ei} - X_{Bi} \\ Z_{Ei} - Z_{Bi} \\ 1 \end{bmatrix} - \begin{bmatrix} \Gamma(\varphi_{4i} - \varphi_{2i}) & 0 \\ 0 & 0 & 1 \end{bmatrix} \cdot \begin{bmatrix} p_4 \\ p_5 \\ 0 \end{bmatrix}, \quad (28)$$

$$\mathbf{g}_{1i}^{(2)} = \begin{bmatrix} \Gamma^{-1}(\varphi_{4i}) & 0 \\ 0 & 0 & 1 \end{bmatrix} \cdot \begin{bmatrix} X_{Ei} - X_{Bi} \\ Z_{Ei} - Z_{Bi} \\ 1 \end{bmatrix} - \begin{bmatrix} \Gamma^{-1}(\varphi_{4i} - \varphi_{2i}) & 0 \\ 0 & 0 & 0 \end{bmatrix} \cdot \begin{bmatrix} p_1 \\ p_2 \\ 0 \end{bmatrix}, \quad (29)$$

$$g_{0i}^{(1)} = -\frac{1}{2}[(X_{Ei} - X_{Bi})^2 + (Z_{Ei} - Z_{Bi})^2] + [X_{Ei} - X_{Bi}, Z_{Ei} - Z_{Bi}] \cdot \Gamma(\varphi_{4i}) \cdot \begin{bmatrix} p_4 \\ p_5 \end{bmatrix}, \quad (30)$$

$$g_{0i}^{(2)} = -\frac{1}{2}[(X_{Ei} - X_{Bi})^2 + (Z_{Ei} - Z_{Bi})^2] - [X_{Ei} - X_{Bi}, Z_{Ei} - Z_{Bi}] \cdot \Gamma(\varphi_{2i}) \cdot \begin{bmatrix} p_1 \\ p_2 \end{bmatrix}, \quad (31)$$

$$\mathbf{g}_{2i}^{(3)} = - \begin{bmatrix} X_{Bi} \\ Z_{Bi} \\ 1 \end{bmatrix} - \begin{bmatrix} \Gamma(\varphi_{2i}) & 0 \\ 0 & 0 & 1 \end{bmatrix} \cdot \begin{bmatrix} p_1 \\ p_2 \\ 0 \end{bmatrix}, \quad (32)$$

$$\mathbf{g}_{2i}^{(4)} = \begin{bmatrix} \Gamma^{-1}(\varphi_{2i}) & 0 \\ 0 & 0 & 1 \end{bmatrix} \cdot \begin{bmatrix} X_{Bi} \\ Z_{Bi} \\ 1 \end{bmatrix} - \begin{bmatrix} \Gamma(\varphi_{2i}) & 0 \\ 0 & 0 & 1 \end{bmatrix} \cdot \begin{bmatrix} p_6 \\ p_7 \\ 0 \end{bmatrix}, \quad (33)$$

$$g_{0i}^{(3)} = -\frac{1}{2}[X_{Bi}^2 + Z_{Bi}^2] + [X_{Bi}, Z_{Bi}] \cdot \Gamma(\varphi_{2i}) \cdot \begin{bmatrix} p_1 \\ p_2 \end{bmatrix}, \quad (34)$$

$$g_{0i}^{(4)} = -\frac{1}{2}[X_{Bi}^2 + Z_{Bi}^2] - [X_{Bi}, Z_{Bi}] \cdot \begin{bmatrix} p_6 \\ p_7 \end{bmatrix}, \quad (35)$$

$$\mathbf{g}_{3i}^{(5)} = - \begin{bmatrix} X_{Ei} \\ Z_{Ei} \\ 1 \end{bmatrix} - \begin{bmatrix} \Gamma(\varphi_{4i}) & 0 \\ 0 & 0 & 1 \end{bmatrix} \cdot \begin{bmatrix} p_4 \\ p_5 \\ 0 \end{bmatrix}, \quad (36)$$

$$\mathbf{g}_{3i}^{(6)} = \begin{bmatrix} \Gamma^{-1}(\varphi_{4i}) & 0 \\ 0 & 0 & 1 \end{bmatrix} \cdot \begin{bmatrix} X_{Ei} \\ Z_{Ei} \\ 1 \end{bmatrix} + \begin{bmatrix} \Gamma(\varphi_{4i}) & 0 \\ 0 & 0 & 1 \end{bmatrix} \cdot \begin{bmatrix} p_6 \\ p_7 \\ 0 \end{bmatrix}. \quad (37)$$

$$g_{0i}^{(5)} = -\frac{1}{2}[X_{Ei}^2 + Z_{Ei}^2] + [X_{Ei}, Z_{Ei}] \cdot \Gamma(\varphi_{4i}) \cdot \begin{bmatrix} p_4 \\ p_5 \end{bmatrix}, \quad (38)$$

$$g_{0i}^{(6)} = -\frac{1}{2}[X_{Ei}^2 + Z_{Ei}^2] - [X_{Ei}, Z_{Ei}] \cdot \begin{bmatrix} p_6 \\ p_7 \end{bmatrix}. \quad (39)$$

Furthermore, the synthesis parameters of the negative CKC *GHI* are determined on the basis of the problems of Chebyshev and least-square approximations [16,17].

### 3. Kinematic Analysis of the PM with Two Grippers

In the kinematic analysis of the PM with two end effectors (Figure 4) for the given geometric parameters of the links and the input angle  $\varphi_{1i}$ , it is necessary to determine the positions and analogues of the velocities and accelerations of the links, including the output points *C* and *F*.

The considered PM with two end effectors has the structural formula:

$$I(1) \rightarrow II(2,5), \rightarrow II(3,4), \quad (40)$$

i.e., it contains two dyads  $II(2,5)$  and  $II(3,4)$ .

According to the structural Formula (40), first, a kinematic analysis of the dyad  $II(2,5)$  is carried out, and then of the dyad  $II(3,4)$ .

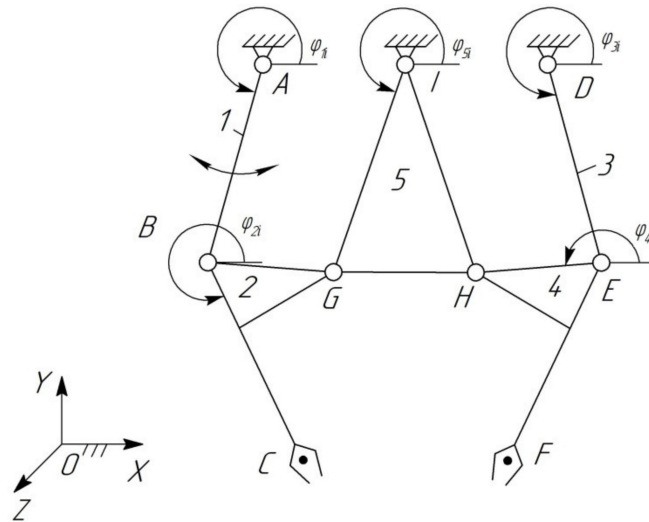

Figure 4. PM with two end effectors.

### 3.1. Kinematic Analysis of the PM with Two Grippers

Let us derive a vector  $BGI$  loop-closure equation:

$$l_{BG} \mathbf{e}_{2i} - l_{IG} \mathbf{e}_{5i} + l_{(IB)i} \mathbf{e}_{(IB)i} = 0, \tag{41}$$

where:

$$l_{(IB)i} = [(X_{Bi} - X_I)^2 + (Z_{Bi} - Z_I)^2]^{\frac{1}{2}}, \tag{42}$$

$$\varphi_{(IB)i} = \text{tg}^{-1} \frac{Z_{Bi} - Z_I}{X_{Bi} - X_I}, \tag{43}$$

$$\begin{bmatrix} X_{Bi} \\ Z_{Bi} \end{bmatrix} = \begin{bmatrix} X_A \\ Z_A \end{bmatrix} + l_{AB} \begin{bmatrix} \cos \varphi_{1i} \\ \sin \varphi_{1i} \end{bmatrix}. \tag{44}$$

Transfer  $l_{BG} \mathbf{e}_{2i}$  to the right side of Equation (41) and square both sides. As a result, we obtain:

$$\varphi_{5i} = \varphi_{(IB)i} + \cos^{-1} \frac{l_{(IB)i}^2 + l_{IG}^2 - l_{BG}^2}{2l_{(IB)i} l_{IG}}. \tag{45}$$

Next, we define:

$$\begin{bmatrix} X_{Gi} \\ Z_{Gi} \end{bmatrix} = \begin{bmatrix} X_I \\ Z_I \end{bmatrix} + l_{IG} \begin{bmatrix} \cos \varphi_{5i} \\ \sin \varphi_{5i} \end{bmatrix}, \tag{46}$$

$$\varphi_{2i} = \text{tg}^{-1} \frac{Z_{Gi} - Z_{Bi}}{X_{Gi} - X_{Bi}}. \tag{47}$$

To solve the problem of the positions of the dyad II (3.4), we derive a vector  $DEH$  loop-closure equation:

$$l_{DE} \mathbf{e}_{3i} + l_{EH} \mathbf{e}_{4i} - l_{(DH)i} \mathbf{e}_{(DH)i} = 0, \tag{48}$$

where:

$$l_{(DH)i} = [(X_{Hi} - X_D)^2 + (Z_{Hi} - Z_D)^2]^{\frac{1}{2}}, \tag{49}$$

$$\varphi_{(DH)i} = \text{tg}^{-1} \frac{Z_{Hi} - Z_D}{X_{Hi} - X_D}, \tag{50}$$

$$\begin{bmatrix} X_{Hi} \\ Z_{Hi} \end{bmatrix} = \begin{bmatrix} X_I \\ Z_I \end{bmatrix} + \begin{bmatrix} \cos \varphi_{5i} & -\sin \varphi_{5i} \\ \sin \varphi_{5i} & \cos \varphi_{5i} \end{bmatrix} \cdot \begin{bmatrix} x_G^{(5)} \\ y_G^{(5)} \end{bmatrix}. \tag{51}$$



Transfer  $l_{EH}\mathbf{e}_{4i}$  to the right side of Equation (48) and square both sides. As a result, we obtain:

$$\varphi_{3i} = \varphi_{(DH)i} + \cos^{-1} \frac{l_{DE}^2 + l_{(DH)i}^2 - l_{EH}^2}{2l_{DE} \cdot l_{(DH)i}}. \tag{52}$$

Next, we define:

$$\begin{bmatrix} X_{Ei} \\ Z_{Ei} \end{bmatrix} = \begin{bmatrix} X_D \\ Z_D \end{bmatrix} + l_{DE} \begin{bmatrix} \cos \varphi_{3i} \\ \sin \varphi_{3i} \end{bmatrix}, \tag{53}$$

$$\varphi_{4i} = \text{tg}^{-1} \frac{Z_{Hi} - Z_{Ei}}{X_{Hi} - X_{Ei}}. \tag{54}$$

Coordinates of the output points C and F in the absolute coordinate system OXYZ are determined by the equations:

$$\begin{bmatrix} X_{Ci} \\ Z_{Ci} \end{bmatrix} = \begin{bmatrix} X_{Bi} \\ Z_{Bi} \end{bmatrix} + \begin{bmatrix} \cos \varphi_{2i} & -\sin \varphi_{2i} \\ \sin \varphi_{2i} & \cos \varphi_{2i} \end{bmatrix} \cdot \begin{bmatrix} x_C^{(2)} \\ y_C^{(2)} \end{bmatrix}, \tag{55}$$

$$\begin{bmatrix} X_{Fi} \\ Z_{Fi} \end{bmatrix} = \begin{bmatrix} X_{Ei} \\ Z_{Ei} \end{bmatrix} + \begin{bmatrix} \cos \varphi_{4i} & -\sin \varphi_{4i} \\ \sin \varphi_{4i} & \cos \varphi_{4i} \end{bmatrix} \cdot \begin{bmatrix} x_F^{(4)} \\ y_F^{(4)} \end{bmatrix}. \tag{56}$$

### 3.2. Analogues of Velocities and Accelerations

To determine the analogues of the angular velocities of the PM with two end effectors, we derive the vector ABGI and IHED loop-closure equations:

$$l_{AB}\mathbf{e}_{1i} + l_{BG}\mathbf{e}_{2i} - l_{IG}\mathbf{e}_{5i} - l_{AI}\mathbf{e}_{AI} = 0 \tag{57}$$

and

$$l_{IH}\mathbf{e}_{(IH)i} - l_{EH}\mathbf{e}_{4i} - l_{DE}\mathbf{e}_{3i} - l_{ID}\mathbf{e}_{ID} = 0 \tag{58}$$

and project them on the axes OX and OZ of the absolute coordinate system OXYZ

$$\left. \begin{aligned} l_{AB} \cos \varphi_{1i} + l_{BG} \cos \varphi_{2i} - l_{IG} \cos \varphi_{5i} - l_{AI} \cos \varphi_{AI} &= 0 \\ l_{AB} \sin \varphi_{1i} + l_{BG} \sin \varphi_{2i} - l_{IG} \sin \varphi_{5i} - l_{AI} \sin \varphi_{AI} &= 0 \end{aligned} \right\} \tag{59}$$

and

$$\left. \begin{aligned} l_{IH} \cos(\varphi_{5i} + \alpha_5) - l_{EH} \cos \varphi_{4i} - l_{DE} \cos \varphi_{3i} - l_{ID} \cos \varphi_{ID} &= 0 \\ l_{IH} \sin(\varphi_{5i} + \alpha_5) - l_{EH} \sin \varphi_{4i} - l_{DE} \sin \varphi_{3i} - l_{ID} \sin \varphi_{ID} &= 0 \end{aligned} \right\} \tag{60}$$

differentiate the systems of Equations (59) and (60) with respect to the generalized coordinate  $\varphi_{1i}$

$$\left. \begin{aligned} -l_{AB} \sin \varphi_{1i} - l_{BG} \sin \varphi_{2i} \cdot \varphi'_{2i} + l_{IG} \sin \varphi_{5i} \cdot \varphi'_{5i} &= 0 \\ l_{AB} \cos \varphi_{1i} + l_{BG} \cos \varphi_{2i} \cdot \varphi'_{2i} - l_{IG} \cos \varphi_{5i} \cdot \varphi'_{5i} &= 0 \end{aligned} \right\} \tag{61}$$

and

$$\left. \begin{aligned} -l_{IH} \sin(\varphi_{5i} + \alpha_5) \cdot \varphi'_{5i} + l_{EH} \sin \varphi_{4i} \cdot \varphi'_{4i} + l_{DE} \sin \varphi_{3i} \cdot \varphi'_{3i} &= 0 \\ l_{IH} \cos(\varphi_{5i} + \alpha_5) \cdot \varphi'_{5i} - l_{EH} \cos \varphi_{4i} \cdot \varphi'_{4i} - l_{DE} \cos \varphi_{3i} \cdot \varphi'_{3i} &= 0 \end{aligned} \right\} \tag{62}$$

From the system of Equation (61), we determine the analogues of the angular velocities  $\varphi'_{2i}$  and  $\varphi'_{5i}$

$$\mathbf{A}_1^{-1} \cdot \mathbf{u}_1 = \mathbf{b}_1 \tag{63}$$

where:

$$\mathbf{A}_1 = \begin{bmatrix} Z_{Bi} - Z_{Gi} & Z_{Gi} - Z_I \\ X_{Gi} - X_{Bi} & X_I - X_{Gi} \end{bmatrix},$$

$$\mathbf{u}_1 = \begin{bmatrix} \varphi'_{2i} \\ \varphi'_{5i} \end{bmatrix}, \quad \mathbf{b}_1 = \begin{bmatrix} Z_{Bi} - Z_A \\ X_A - X_{Bi} \end{bmatrix}.$$

Substituting the obtained values of the angular velocity analogue  $\varphi'_{5i}$  into the system of Equation (62), from this system, we determine the angular velocities analogues  $\varphi'_{3i}$  and  $\varphi'_{4i}$

$$\mathbf{A}_2^{-1} \cdot \mathbf{u}_2 = \mathbf{b}_2, \tag{64}$$

where:

$$\mathbf{A}_2 = \begin{bmatrix} Z_{Ei} - Z_D & Z_{Hi} - Z_{Ei} \\ X_D - X_{Ei} & X_{Ei} - X_{Hi} \end{bmatrix},$$

$$\mathbf{u}_2 = \begin{bmatrix} \varphi'_{3i} \\ \varphi'_{4i} \end{bmatrix}, \quad \mathbf{b}_2 = \begin{bmatrix} (Z_{Hi} - Z_I) \cdot \varphi'_{5i} \\ (X_I - X_{Hi}) \cdot \varphi'_{5i} \end{bmatrix}.$$

Projections of the linear velocities analogues of the output points C and F on the axis of the absolute coordinate system OXYZ are determined by differentiating Equations (55) and (56) with respect to the generalized coordinate  $\varphi_{1i}$

$$\begin{bmatrix} u_{Ci}^X \\ u_{Ci}^Z \end{bmatrix} = \begin{bmatrix} u_{Bi}^X \\ u_{Bi}^Z \end{bmatrix} + \begin{bmatrix} -\sin \varphi_{2i} & -\cos \varphi_{2i} \\ \cos \varphi_{2i} & -\sin \varphi_{2i} \end{bmatrix} \cdot \begin{bmatrix} x_C^{(2)} \\ y_C^{(2)} \end{bmatrix} \cdot \varphi'_{2i}, \tag{65}$$

$$\begin{bmatrix} u_{Fi}^X \\ u_{Fi}^Z \end{bmatrix} = \begin{bmatrix} u_{Ei}^X \\ u_{Ei}^Z \end{bmatrix} + \begin{bmatrix} -\sin \varphi_{4i} & -\cos \varphi_{4i} \\ \cos \varphi_{4i} & -\sin \varphi_{4i} \end{bmatrix} \cdot \begin{bmatrix} x_F^{(4)} \\ y_F^{(4)} \end{bmatrix} \cdot \varphi'_{4i}, \tag{66}$$

where the projections of the linear velocity analogues of the joints B and E are determined by differentiating Equations (44) and (53) with respect to the generalized coordinate  $\varphi_{1i}$

$$\begin{bmatrix} u_{Bi}^X \\ u_{Bi}^Z \end{bmatrix} = l_{AB} \begin{bmatrix} -\sin \varphi_{1i} \\ \cos \varphi_{1i} \end{bmatrix}, \tag{67}$$

$$\begin{bmatrix} u_{Ei}^X \\ u_{Ei}^Z \end{bmatrix} = l_{DE} \begin{bmatrix} -\sin \varphi_{3i} \\ \cos \varphi_{3i} \end{bmatrix} \cdot \varphi'_{3i}. \tag{68}$$

To determine the angular acceleration analogues of the links, we differentiate the systems of Equations (61) and (62) with respect to the generalized coordinate  $\varphi_{1i}$

$$\left. \begin{aligned} -l_{AB} \cos \varphi_{1i} - l_{BG} \cos \varphi_{2i} \cdot \varphi'^2_{2i} - l_{BG} \sin \varphi_{2i} \cdot \varphi''_{2i} + \\ l_{IG} \cos \varphi_{5i} \cdot \varphi'^2_{5i} + l_{IG} \sin \varphi_{5i} \cdot \varphi''_{5i} = 0 \\ -l_{AB} \sin \varphi_{1i} - l_{BG} \sin \varphi_{2i} \cdot \varphi'^2_{2i} + l_{BG} \cos \varphi_{2i} \cdot \varphi''_{2i} + \\ l_{IG} \sin \varphi_{5i} \cdot \varphi'^2_{5i} - l_{IG} \cos \varphi_{5i} \cdot \varphi''_{5i} = 0 \end{aligned} \right\} \tag{69}$$

and

$$\left. \begin{aligned} -l_{IH} \cos(\varphi_{5i} + \alpha_5) \cdot \varphi'^2_{5i} - l_{IH} \sin(\varphi_{5i} + \alpha_5) \cdot \varphi''_{5i} + l_{EH} \cos \varphi_{4i} \cdot \varphi'^2_{4i} \\ + l_{EH} \sin \varphi_{4i} \cdot \varphi''_{4i} + l_{DE} \cos \varphi_{3i} \cdot \varphi'^2_{3i} + l_{DE} \sin \varphi_{3i} \cdot \varphi''_{3i} = 0 \\ -l_{IH} \sin(\varphi_{5i} + \alpha_5) \cdot \varphi'^2_{5i} + l_{IH} \cos(\varphi_{5i} + \alpha_5) \cdot \varphi''_{5i} + l_{EH} \sin \varphi_{4i} \cdot \varphi'^2_{4i} \\ - l_{EH} \cos \varphi_{4i} \cdot \varphi''_{4i} + l_{DE} \sin \varphi_{3i} \cdot \varphi'^2_{3i} - l_{DE} \cos \varphi_{3i} \cdot \varphi''_{3i} = 0 \end{aligned} \right\} \tag{70}$$

From the systems of Equation (69), we determine the angular accelerations analogues  $\varphi''_{2i}$  and  $\varphi''_{5i}$

$$\mathbf{A}_1^{-1} \cdot \mathbf{w}_1 = \mathbf{b}_3, \tag{71}$$

where:

$$\mathbf{w}_1 = \begin{bmatrix} \varphi''_{2i} \\ \varphi''_{5i} \end{bmatrix}, \quad \mathbf{b}_3 = \begin{bmatrix} (X_{Bi} - X_A) + (X_{Gi} - X_{Bi}) \cdot \varphi'^2_{2i} + (X_I - X_{Gi}) \cdot \varphi'^2_{5i} \\ (Z_{Bi} - Z_A) + (Z_{Gi} - Z_A) \cdot \varphi'^2_{2i} + (Z_I - Z_{Gi}) \cdot \varphi'^2_{5i} \end{bmatrix}.$$

Substituting the obtained values of the angular velocity analogues  $\varphi''_{2i}$  and  $\varphi''_{5i}$  into the system of Equation (70), from this system, we determine the angular velocities analogues  $\varphi''_{3i}$  and  $\varphi''_{4i}$

$$\mathbf{A}_2^{-1} \cdot \mathbf{w}_2 = \mathbf{b}_4, \tag{72}$$

where:

$$\mathbf{w}_2 = \begin{bmatrix} \varphi''_{3i} \\ \varphi''_{4i} \end{bmatrix}, \mathbf{b}_4 = \begin{bmatrix} (X_{Hi} - X_I) \cdot \varphi'^2_{5i} + (X_{Ei} - X_{Hi}) \cdot \varphi'^2_{4i} + (X_D - X_{Ei}) \cdot \varphi'^2_{3i} \\ (Z_{Hi} - Z_I) \cdot \varphi'^2_{5i} + (Z_{Ei} - Z_{Hi}) \cdot \varphi'^2_{4i} + (Z_D - Z_{Ei}) \cdot \varphi'^2_{3i} \end{bmatrix}. \tag{73}$$

Projections of the linear velocities analogues of the output points C and F on the axis of the absolute coordinate system OXYZ are determined by differentiating Equations (65) and (66) with respect to the generalized coordinate  $\varphi_{1i}$

$$\begin{bmatrix} w^X_{Ci} \\ w^Z_{Ci} \end{bmatrix} = \begin{bmatrix} w^X_{Bi} \\ w^Z_{Bi} \end{bmatrix} + \begin{bmatrix} -\cos \varphi_{2i} & \sin \varphi_{2i} \\ -\sin \varphi_{2i} & -\cos \varphi_{2i} \end{bmatrix} \cdot \begin{bmatrix} x^{(2)}_C \\ z^{(2)}_C \end{bmatrix} \cdot \varphi'^2_{2i} + \begin{bmatrix} -\sin \varphi_{2i} & -\cos \varphi_{2i} \\ \cos \varphi_{2i} & -\sin \varphi_{2i} \end{bmatrix} \cdot \begin{bmatrix} x^{(2)}_C \\ z^{(2)}_C \end{bmatrix} \cdot \varphi''_{2i}, \tag{74}$$

$$\begin{bmatrix} w^X_{Fi} \\ w^Z_{Fi} \end{bmatrix} = \begin{bmatrix} w^X_{Ei} \\ w^Z_{Ei} \end{bmatrix} + \begin{bmatrix} -\cos \varphi_{4i} & \sin \varphi_{4i} \\ -\sin \varphi_{4i} & -\cos \varphi_{4i} \end{bmatrix} \cdot \begin{bmatrix} x^{(4)}_F \\ z^{(4)}_F \end{bmatrix} \cdot \varphi'^2_{4i} + \begin{bmatrix} -\sin \varphi_{4i} & -\cos \varphi_{4i} \\ \cos \varphi_{4i} & -\sin \varphi_{4i} \end{bmatrix} \cdot \begin{bmatrix} x^{(4)}_F \\ z^{(4)}_F \end{bmatrix} \cdot \varphi''_{4i}, \tag{75}$$

where the projections of the linear velocity analogues of the joints B and E are determined by differentiating Equations (67) and (68) with respect to the generalized coordinate  $\varphi_{1i}$

$$\begin{bmatrix} w^X_{Bi} \\ w^Z_{Bi} \end{bmatrix} = l_{AB} \begin{bmatrix} -\cos \varphi_{1i} \\ -\sin \varphi_{1i} \end{bmatrix}, \tag{76}$$

$$\begin{bmatrix} w^X_{Ei} \\ w^Z_{Ei} \end{bmatrix} = l_{DE} \begin{bmatrix} -\cos \varphi_{3i} \\ -\sin \varphi_{3i} \end{bmatrix} \cdot \varphi'^2_{3i} + \begin{bmatrix} -\sin \varphi_{3i} \\ \cos \varphi_{3i} \end{bmatrix} \cdot \varphi''_{3i}, \tag{77}$$

#### 4. Numerical Results

Table 1 shows  $N = 11$  positions of the grippers  $P_1$  and  $P_2$  of the PM with two end effectors.

**Table 1.** Positions of the grippers  $P_1$  and  $P_2$ .

| $i$                | 1        | 2        | 3        | 4        | 5        | 6        | 7        | 8        | 9        | 10       | 11       |
|--------------------|----------|----------|----------|----------|----------|----------|----------|----------|----------|----------|----------|
| $X_{P_{1,i}}$ , mm | 0        | 4.6      | 9.2      | 13.8     | 18.40    | 23.0     | 27.60    | 32.20    | 36.80    | 41.40    | 46.3882  |
| $Y_{P_{1,i}}$ , mm | 0        | -6.2512  | -11.0478 | -14.8398 | -17.8092 | -20.1433 | -21.8922 | -23.1166 | -23.8528 | -24.1065 | -23.8384 |
| $X_{P_{2,i}}$ , mm | 46.3882  | 53.5938  | 59.8359  | 65.3367  | 70.4344  | 75.0223  | 79.1896  | 82.9453  | 86.4738  | 89.6476  | 92.7766  |
| $Y_{P_{2,i}}$ , mm | -23.8384 | -24.0439 | -23.2688 | -21.8398 | -19.8480 | -17.4431 | -14.6785 | -11.6242 | -8.1590  | -4.4228  | 0        |

Tables 2–4 show the obtained values of the synthesis parameters of the two passive CKCs ABC, DEF and negative CKC GHI, respectively.

**Table 2.** Synthesis parameters of the CKC ABC.

| $X_A$ , mm | $Z_A$ , mm | $l_{AB}$ , mm | $l_{BC}$ , mm |
|------------|------------|---------------|---------------|
| 14.04      | -57.11     | 46.5309       | 43.0          |

**Table 3.** Synthesis parameters of the CKC DEF.

| $X_D$ , mm | $Z_D$ , mm | $l_{DE}$ , mm | $l_{EF}$ , mm |
|------------|------------|---------------|---------------|
| 78.74      | -57.11     | 46.5309       | 43.0          |

**Table 4.** Synthesis parameters of the CKC *GHI*.

|                  |                  |                  |                  |               |            |            |               |               |
|------------------|------------------|------------------|------------------|---------------|------------|------------|---------------|---------------|
| $x_G^{(2)}$ , mm | $y_G^{(2)}$ , mm | $x_H^{(4)}$ , mm | $y_H^{(4)}$ , mm | $l_{GH}$ , mm | $X_I$ , mm | $Z_I$ , mm | $l_{GI}$ , mm | $l_{HI}$ , mm |
| 6.6072           | 9.9607           | −6.6072          | −9.9607          | 45.0          | 46.39      | 57.11      | 50.0          | 50.0          |

3D CAD model of the synthesized PM with two grippers is shown in Figure 5.

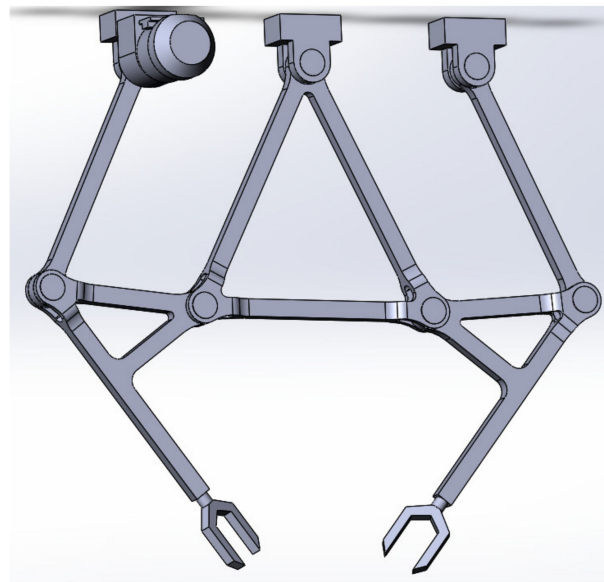

**Figure 5.** 3D CAD model of the PM with two grippers.

Table 5 shows the obtained values of the coordinates  $X_{P_{1,i}}, Y_{P_{1,i}}, X_{P_{2,i}}, Y_{P_{2,i}}$  and projections of analogues of linear velocities  $u_{P_{1,i}}^X, u_{P_{1,i}}^Z, u_{P_{2,i}}^X, u_{P_{2,i}}^Z$  and linear accelerations  $w_{P_{1,i}}^X, w_{P_{1,i}}^Z, w_{P_{2,i}}^X, w_{P_{2,i}}^Z$  of the grippers of the PM with two end effectors.

**Table 5.** Positions and analogues of linear velocities and accelerations of the grippers.

| $i$                  | 1        | 2        | 3        | 4        | 5        | 6        | 7        | 8        | 9        | 10       | 11       |
|----------------------|----------|----------|----------|----------|----------|----------|----------|----------|----------|----------|----------|
| $X_{P_{1,i}}$ , mm   | 0        | 4.6      | 9.2      | 13.8     | 18.40    | 23.0     | 27.60    | 32.20    | 36.80    | 41.40    | 46.3882  |
| $Z_{P_{1,i}}$ , mm   | 0        | −6.2512  | −11.0478 | −14.8398 | −17.8092 | −20.1433 | −21.8922 | −23.1166 | −23.8528 | −24.1065 | −23.8384 |
| $X_{P_{2,i}}$ , mm   | 46.3882  | 53.5938  | 59.8359  | 65.3367  | 70.4344  | 75.0223  | 79.1896  | 82.9453  | 86.4738  | 89.6476  | 92.7766  |
| $Z_{P_{2,i}}$ , mm   | −23.8384 | −24.0439 | −23.2688 | −21.8398 | −19.8480 | −17.4431 | −14.6785 | −11.6242 | −8.1590  | −4.4228  | 0        |
| $u_{P_{1,i}}^X$ , mm | 0.8440   | 0.5204   | 0.2432   | −0.026   | −0.276   | −0.495   | −0.693   | −0.8729  | −1.036   | −1.184   | −1.325   |
| $u_{P_{1,i}}^Z$ , mm | 0.9830   | 0.9627   | 0.9489   | 0.9362   | 0.9236   | 0.9110   | 0.8977   | 0.8829   | 0.8662   | 0.8465   | 0.8211   |
| $u_{P_{2,i}}^X$ , mm | 1.0733   | 1.0380   | 1.0173   | 0.9998   | 0.9845   | 0.9710   | 0.9583   | 0.9459   | 0.9335   | 0.9212   | 0.9094   |
| $u_{P_{2,i}}^Z$ , mm | −0.1071  | −0.0733  | −0.0650  | −0.0515  | −0.0399  | −0.0294  | −0.0189  | −0.0075  | 0.0062   | 0.0240   | 0.0515   |
| $w_{P_{1,i}}^X$ , mm | −0.1096  | −0.1066  | −0.0868  | −0.1056  | −0.1964  | −0.3570  | −0.5768  | −0.8396  | −1.1265  | −1.4157  | −1.6956  |
| $w_{P_{1,i}}^Z$ , mm | −0.8688  | −0.2504  | −0.0283  | 0.0221   | −0.0380  | −0.1620  | −0.3271  | −0.5223  | −0.7421  | −0.9843  | −1.2642  |
| $w_{P_{2,i}}^X$ , mm | −0.1116  | −0.0885  | −0.0968  | −0.1112  | −0.1353  | −0.1676  | −0.2100  | −0.2661  | −0.3420  | −0.4486  | −0.6182  |
| $w_{P_{2,i}}^Z$ , mm | 0.6401   | 0.4710   | 0.3803   | 0.3069   | 0.2416   | 0.1771   | 0.1038   | 0.01319  | −0.1059  | −0.2713  | −0.5320  |

Positions and modules of the velocities and acceleration analogues of the synthesized PM grippers  $P_1$  and  $P_2$  are also presented with the graphical plots in Figures 6–8.

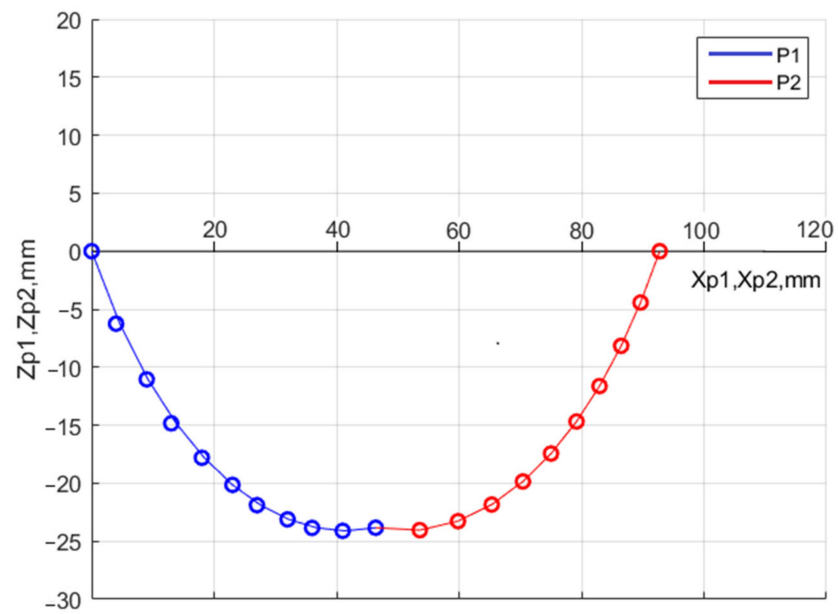

Figure 6. Graphics of the grippers  $P_1$  and  $P_2$  positions.

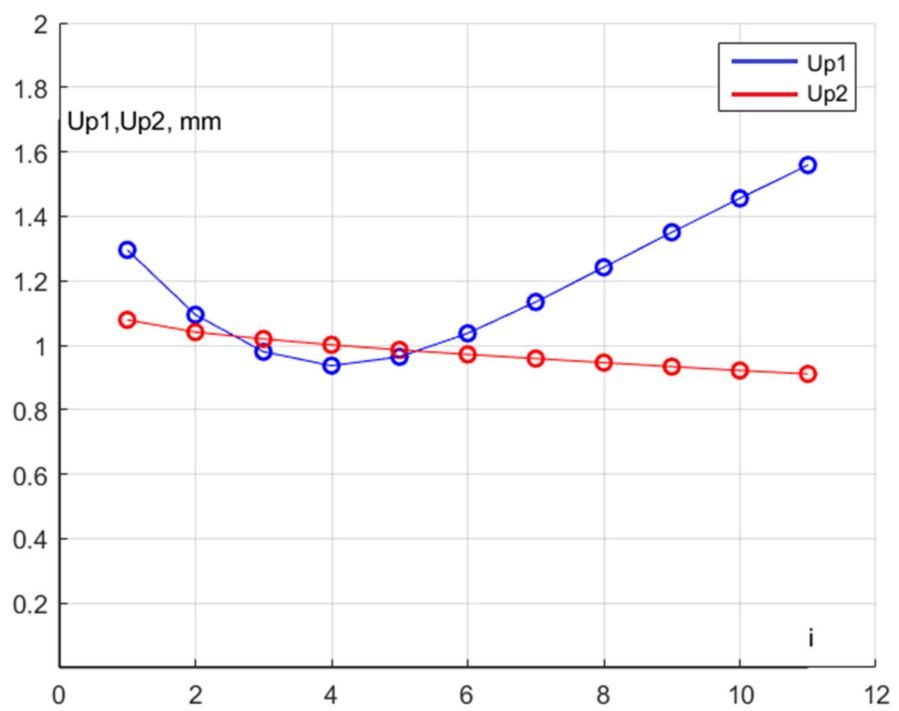
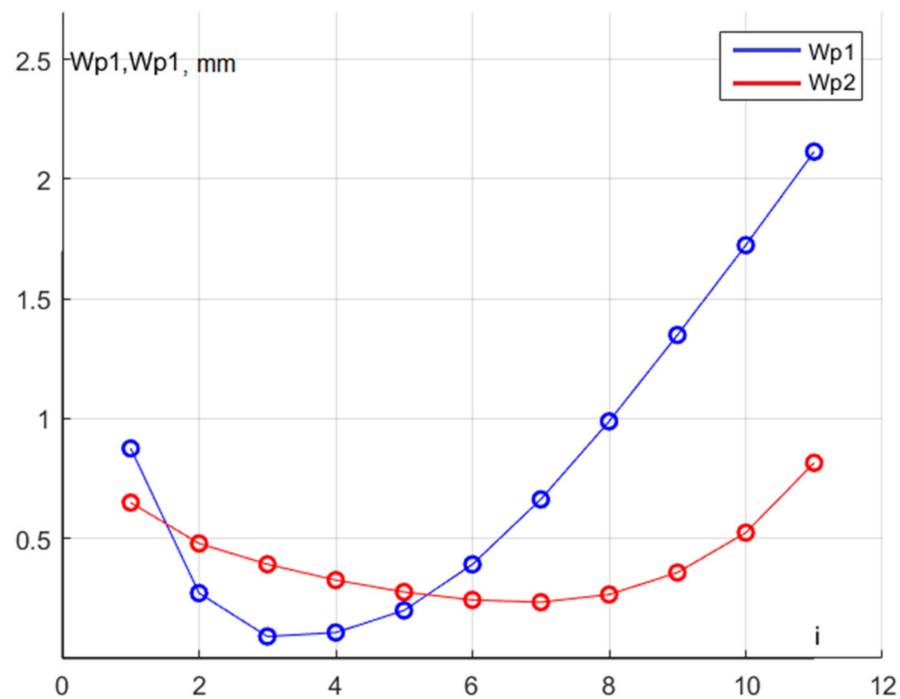

Figure 7. Graphics of the grippers  $P_1$  and  $P_2$  linear velocities analogues.



**Figure 8.** Graphics of the grippers  $P_1$  and  $P_2$  linear accelerations analogues.

## 5. Conclusions

Kinematic synthesis and analysis of the PM with two end effectors have been carried out. In the kinematic synthesis according to the given laws of motions (or positions) of two end effectors, the structural scheme, and geometric parameters of links of the synthesized PM are determined. The structural scheme of this PM is formed by connecting two output objects (end effectors) and a base using three CKCs: two passive and one negative CKC. Passive and negative CKCs are structural modules from which the PM is formed. Passive CKCs are two movable serial manipulators, and the negative CKCs is a three-jointed link. Serial manipulators (passive CKCs) do not impose geometric constraints on the movement of the output objects, and the three-jointed link (negative CKC) imposes three geometric constraints. Therefore, the geometric parameters of the links of the negative CKCs are determined, and the geometric parameters of the links of the passive CKCs are varied depending on the imposed geometric constraints of the negative CKC. Kinematic synthesis of the negative CKC was carried out on the basis of the Chebyshev and least-square approximations. Since the structure of the synthesized PM consists of two dyads, the position analysis is solved analytically. Analogues of angular velocities and accelerations are determined from two systems of linear equations obtained by differentiating the loop-closure equations with respect to the generalized coordinate.

**Author Contributions:** Z.B. established the methods of structural and kinematic synthesis of the RoboMech class parallel manipulator (PM) with two grippers. M.A.L. established the methods of kinematic analysis of this PM. A.M. created the programs in the MatLab for kinematic synthesis of the PM and obtained numerical results. A.K. created the programs in the MatLab for kinematic analysis of the PM and obtained numerical results. All authors contributed equally to the evaluation of the results and writing of this paper. All authors have read and agreed to the published version of the manuscript.

**Funding:** This research is funded by the Science Committee of the Ministry of Education and Science of the Republic of Kazakhstan (Grant No. AP08857522).

**Institutional Review Board Statement:** Not applicable.

**Informed Consent Statement:** Not applicable.

**Data Availability Statement:** The data presented in this study are available on request from the corresponding author.

**Conflicts of Interest:** The authors declare no conflict of interest.

## References

1. Baigunchekov, Z.; Kalimoldayev, M.; Ibrayev, S.; Izmambetov, M.; Baigunchekov, T.; Naurushev, B.; Aisa, N. Parallel Manipulator of a Class RoboMech. *Lect. Notes Electr. Eng.* **2017**, *408*, 547–557.
2. Paul, B. *Kinematics and Dynamics of Planar Machinery*; Prentice-Hall: Hoboken, NJ, USA, 1979.
3. Hartenberg, R.S.; Denavit, J. *Kinematic Synthesis of Linkages*; McGraw-Hill: New York, NY, USA, 1964.
4. Rodhavan, M.; Roth, B. Solving Polynomial Systems for the Kinematic Analysis and Synthesis of Mechanisms and Robot Manipulators. *J. Mech. Des.* **1995**, *117*, 71–79.
5. Erdman, A.G.; Sandor, G.N.; Kota, S. *Mechanism Design: Analysis and Synthesis Lecture Notes*; McGill University: Montreal, QC, Canada, 2001.
6. Uicker, J.J.; Pennack, G.R.; Shigley, J.E. *Theory of Machines and Mechanisms*, 4th ed.; Oxford University Press: New York, NY, USA, 2001.
7. Hernandez, A.; Petya, V. Position Analysis of Planar Mechanisms with R-pairs Using Geometrical-Iterative Method. *Mech. Mach. Theory* **2004**, *39*, 50–61. [[CrossRef](#)]
8. Pennock, G.R.; Israr, A. Kinematic Analysis and Synthesis of an Adjustable Six-Bar Linkage. *Mech. Mach. Theory* **2009**, *44*, 306–323. [[CrossRef](#)]
9. McCarthy, J.M.; Soh, G.M. *Geometric Design of Linkages*, 2nd ed.; Springer Science & Business Media: Berlin/Heidelberg, Germany, 2010.
10. Angeles, J.; Bai, S.H. *Kinematic Synthesis, Lecture Notes*; McGill University: Montreal, QC, Canada, 2016.
11. Duffy, J. *Analysis of Mechanisms and Robot Manipulator*; Edward Arnold: London, UK, 1980.
12. Tsai, L.W. *Robot Analysis: The Mechanics of Serial and Parallel Manipulators*; John Wiley and Sons, Inc.: New York, NY, USA, 1999.
13. Glazunov, V. Design of Decoupled Parallel Manipulators by Means of the Theory of Screws. *Mech. Mach. Theory* **2010**, *45*, 209–230. [[CrossRef](#)]
14. McCarthy, J.M. Kinematics, Polynomials, and Computers—A Brief History. *J. Mech. Robot.* **2011**, *3*, 010201-1. [[CrossRef](#)]
15. McCarthy, J.M. 21st Kinematics Synthesis, Compliance, and Tensegrity. *J. Mech. Robot.* **2011**, *3*, 020202-1. [[CrossRef](#)]
16. Wang, D.; Wang, L.; Wu, J. Physics-Based Mechatronics Modeling and Application of an Industrial-Grade Parallel Tool Head. *Mech. Syst. Signal Process.* **2021**, *148*, 107158. [[CrossRef](#)]
17. Bourbonnais, F.; Bigras, P.; Bonev, I.A. Minimum-Time Trajectory Planning and Control of a Pick-and-Place Five-Bar Parallel Robot. *IEEE/ASME Trans. Mechatron.* **2014**, *20*, 740–749. [[CrossRef](#)]
18. Zhang, Z.; Wang, L.; Shao, Z. Improving the Kinematic Performance of a Planar 3-RRR Parallel Manipulator Through Actuation Mode Conversion. *Mech. Mach. Theory* **2018**, *130*, 86–108. [[CrossRef](#)]
19. Carabin, G.; Scalera, L.; Wongratanaphisan, T.; Vidoni, R. An Energy-Efficient Approach for 3D Printing with a Linear Delta Robot Equipped with Optimal Springs. *Robot. Comput. Integr. Manuf.* **2021**, *67*, 102045. [[CrossRef](#)]
20. Scalera, L.; Carabin, G.; Vidoni, R.; Wongratanaphisan, T. Energy Efficiency in a 4-DOF Parallel Robot Featuring Compliant Elements. *Int. J. Mech. Control* **2019**, *20*, 49–57.
21. Hu, B.; Shi, D.; Xie, T.; Hu, B.; Ye, N. Kinematically Identical Manipulators Derivation for the 2-RPU+ UPR Parallel Manipulator and Their Constraint Performance Comparison. *J. Mech. Robot.* **2020**, *6*, 061011. [[CrossRef](#)]
22. Baigunchekov, Z.; Ibrayev, S.; Izmambetov, M.; Mustafa, A.; Sagyntay, M. Synthesis of Reconfigurable Positioning Parallel Manipulator of a Class RoboMech. In Proceedings of the 2018 International Conference on Reconfigurable Mechanisms and Robots, ReMAR, Delft, The Netherlands, 20–22 June 2018.
23. Baigunchekov, Z.; Izmambetov, M.; Zhumasheva, Z.; Baigunchekov, T.; Mustafa, A. Parallel Manipulator of a Class RoboMech for Generation of Horizontal Trajectories Family. *Mech. Mach. Sci.* **2019**, *73*, 1395–1402.
24. Grabchenko, I.P.; Klepnikov, V.B.; Dobroskok, V.L.; Kryzhni, G.K. *Introduction to Mechatronics*; HPI: Harkov, Ukraine, 2017.
25. Sobol, I.M.; Statnikov, R.B. *Choice of Optimal Parameters in Problems with Many Criteria*; Nauka: Moscow, Russian, 1981.
26. Artobolevskiy, I.I. *Theory of Mechanisms and Machines*; Nauka: Moscow, Russian, 1988.