



HAL
open science

Behavior of Circular Fiber-Reinforced Polymer-Steel-Confined Concrete Columns Subjected to Reversed Cyclic Loads: Experimental Studies and Finite-Element Analysis

Yanlei Wang, Gaochuang Cai, Yunyu Li, Daniele Waldmann, Amir Si Larbi,
Konstantinos Daniel Tsavdaridis

► To cite this version:

Yanlei Wang, Gaochuang Cai, Yunyu Li, Daniele Waldmann, Amir Si Larbi, et al.. Behavior of Circular Fiber-Reinforced Polymer-Steel-Confined Concrete Columns Subjected to Reversed Cyclic Loads: Experimental Studies and Finite-Element Analysis. *Journal of Structural Engineering*, 2019, 145 (9), 10.1061/(ASCE)ST.1943-541X.0002373 . hal-04084658

HAL Id: hal-04084658

<https://hal.science/hal-04084658v1>

Submitted on 28 Jan 2025

HAL is a multi-disciplinary open access archive for the deposit and dissemination of scientific research documents, whether they are published or not. The documents may come from teaching and research institutions in France or abroad, or from public or private research centers.

L'archive ouverte pluridisciplinaire **HAL**, est destinée au dépôt et à la diffusion de documents scientifiques de niveau recherche, publiés ou non, émanant des établissements d'enseignement et de recherche français ou étrangers, des laboratoires publics ou privés.



City Research Online

City, University of London Institutional Repository

Citation: Wang, Y., Cai, G., Li, Y., Waldmann, D., Si Larbi, A. & Tsavdaridis, K. D. (2019). Behavior of Circular Fiber-Reinforced Polymer-Steel-Confined Concrete Columns Subjected to Reversed Cyclic Loads: Experimental Studies and Finite-Element Analysis. *Journal of Structural Engineering*, 145(9), 04019085. doi: 10.1061/(asce)st.1943-541x.0002373

This is the accepted version of the paper.

This version of the publication may differ from the final published version.

Permanent repository link: <https://openaccess.city.ac.uk/id/eprint/26993/>

Link to published version: [https://doi.org/10.1061/\(asce\)st.1943-541x.0002373](https://doi.org/10.1061/(asce)st.1943-541x.0002373)

Copyright: City Research Online aims to make research outputs of City, University of London available to a wider audience. Copyright and Moral Rights remain with the author(s) and/or copyright holders. URLs from City Research Online may be freely distributed and linked to.

Reuse: Copies of full items can be used for personal research or study, educational, or not-for-profit purposes without prior permission or charge. Provided that the authors, title and full bibliographic details are credited, a hyperlink and/or URL is given for the original metadata page and the content is not changed in any way.

City Research Online:

<http://openaccess.city.ac.uk/>

publications@city.ac.uk



City Research Online

City, University of London Institutional Repository

Citation: Wang, Y, Cai, G, Li, Y, Waldmann, D, Si Larbi, A and Tsavdaridis, KD ORCID: 0000-0001-8349-3979 (2019). Behavior of Circular Fiber-Reinforced Polymer-Steel-Confining Concrete Columns Subjected to Reversed Cyclic Loads: Experimental Studies and Finite-Element Analysis. *Journal of Structural Engineering (United States)*, 145(9), doi: 10.1061/(ASCE)ST.1943-541X.0002373

This is the draft version of the paper.

This version of the publication may differ from the final published version.

Permanent repository link: <https://openaccess.city.ac.uk/id/eprint/26993/>

Link to published version: [http://dx.doi.org/10.1061/\(ASCE\)ST.1943-541X.0002373](http://dx.doi.org/10.1061/(ASCE)ST.1943-541X.0002373)

Copyright: City Research Online aims to make research outputs of City, University of London available to a wider audience. Copyright and Moral Rights remain with the author(s) and/or copyright holders. URLs from City Research Online may be freely distributed and linked to.

Reuse: Copies of full items can be used for personal research or study, educational, or not-for-profit purposes without prior permission or charge. Provided that the authors, title and full bibliographic details are credited, a hyperlink and/or URL is given for the original metadata page and the content is not changed in any way.

City Research Online:

<http://openaccess.city.ac.uk/>

publications@city.ac.uk



UNIVERSITY OF LEEDS

This is a repository copy of *Behavior of Circular Fiber-Reinforced Polymer–Steel-Confined Concrete Columns Subjected to Reversed Cyclic Loads: Experimental Studies and Finite-Element Analysis*.

White Rose Research Online URL for this paper:
<http://eprints.whiterose.ac.uk/143846/>

Version: Accepted Version

Article:

Wang, Y, Cai, G, Li, Y et al. (3 more authors) (2019) Behavior of Circular Fiber-Reinforced Polymer–Steel-Confined Concrete Columns Subjected to Reversed Cyclic Loads: Experimental Studies and Finite-Element Analysis. *Journal of Structural Engineering*, 145 (9). 04019085. ISSN 0733-9445

[https://doi.org/10.1061/\(ASCE\)ST.1943-541X.0002373](https://doi.org/10.1061/(ASCE)ST.1943-541X.0002373)

©2019 American Society of Civil Engineers. This is an author produced version of a paper published in *Journal of Structural Engineering*. Uploaded in accordance with the publisher's self-archiving policy.

Reuse

Items deposited in White Rose Research Online are protected by copyright, with all rights reserved unless indicated otherwise. They may be downloaded and/or printed for private study, or other acts as permitted by national copyright laws. The publisher or other rights holders may allow further reproduction and re-use of the full text version. This is indicated by the licence information on the White Rose Research Online record for the item.

Takedown

If you consider content in White Rose Research Online to be in breach of UK law, please notify us by emailing eprints@whiterose.ac.uk including the URL of the record and the reason for the withdrawal request.



eprints@whiterose.ac.uk
<https://eprints.whiterose.ac.uk/>

Behaviour of Circular FRP-Steel Confined Concrete Columns Subjected to Reversed Cyclic Loads: Experimental Studies and FE Analysis

Yanlei Wang¹, Gaochuang Cai^{2*}, Yunyu Li³, Danièle Waldmann⁴, Amir Si Larbi⁵,

Konstantinos Daniel Tsavdaridis⁶

Abstract

This paper studies experimentally the behaviour of circular FRP-steel confined concrete columns subjected to reversed cyclic loads. The influence of main structural factors on the cyclic behaviour of the columns is discussed. Test results show the outstanding seismic performance of FRP-steel confined reinforced concrete (RC) and steel-reinforced concrete (SRC) columns. The lateral confinement effectiveness of GFRP tube and GFRP-steel tube was verified and a simplified OpenSees-based finite element method (FEM) model was developed to simulate the experimental results of the test columns. Based on the proposed FEM model, a parametric analysis was conducted for investigating the effects of main factors on the reversed cyclic behaviour of GFRP-steel confined RC columns. Based on the test and numerical analyses, the study discussed the influence of variables such as the lateral confinement on the plastic hinge region (PHR) height and peak drift ratio of the columns under reversed cyclic loads. Results indicate that the lateral confinement significantly affects the PHR height of the circular confined RC columns. Based on the analyses of the data from this study and literature, a simple model was suggested to predict the peak drift ratio of the confined RC columns.

¹ Associate professor, State Key Laboratory of Coastal and Offshore Engineering, School of Civil Engineering, Dalian University of technology, Dalian 116024, China.

² Invited professor, Univ Lyon, Ecole Nationale d'Ingénieurs de Saint-Etienne (ENISE), Laboratoire de Tribologie et de Dynamique des Systèmes, UMR 5513, 58 Rue Jean Parot, 42023 Saint-Etienne Cedex 2, France ; Assistant professor, Faculty of Engineering, Fukuoka University, Fukuoka, Japan. (Corresponding author), Email: gaochuang.cai@enise.fr;

³ Lecturer, School of Transportation, Wuhan University of Technology, Wuhan 430063, China.

⁴ Associate professor, Laboratory of Solid Structures, University of Luxembourg, Maison du Nombre, 6, Avenue de la Fonte, L-4364 Esch-sur-Alzette, Luxembourg.

⁵ Full Professor, Univ Lyon, Ecole Nationale d'Ingénieurs de Saint-Etienne (ENISE), Laboratoire de Tribologie et de Dynamique des Systèmes, UMR 5513, 58 Rue Jean Parot, 42023 Saint-Etienne Cedex 2, France.

⁶ Associate professor, School of Civil Engineering, University of Leeds, Woodhouse Lane, Leeds, LS2 9JT, UK.

22 **Keywords:** Seismic behaviour; FRP; Lateral confinement; Plastic hinge region; composite
23 structure; Hysteresis behaviour

24

25 **1. Introduction**

26 It is generally accepted that properly confined concrete can develop adequate ductility for reinforced
27 concrete (RC) elements allowing sufficient lateral deformability without a significant reduction in
28 strength. For RC beams and columns, their confinement is usually located at the plastic hinge regions
29 (PHR) by using different external constraints such as steel tube (Tomii 1985a, 1985b) and fibre
30 reinforced polymer (FRP) sheet (Teng et al. 2002). Moreover, the confinement can further enhance
31 the deformability and ductility of RC columns subjected to reversed cyclic loads, which is meaningful
32 for concrete structures in seismic regions or for high-rise buildings. This is because that unconfined
33 concrete elements might fail due to damage accumulation during reversed cyclic loads, thus leading
34 to subsequent further damage or the collapse of whole structure.

35 Fig.1 shows the main confinement methods of two kinds of concrete elements: (i) RC, and (ii)
36 concrete-filled steel tube (CFST) elements. For the former, the addition of external steel tube
37 confinement was suggested to improve the ductility, deformation, and damage control of the concrete
38 cover of RC elements. The concept of “tubed column” was first introduced to the research community
39 by Tomii et al (1985a,b), which is called as steel tube confined columns. The lateral tubed
40 confinement at the same time significantly enhances the bearing capacity of the RC elements.
41 Additionally, the external steel tube can work as a part of the formwork system to quicken the
42 construction. Since steel tube confined concrete (STCC) elements initially were used in the
43 construction industry and presents excellent deformation ability and ductility, the research community
44 has also presented increasing concerns. This can be attributed to the fact that the STCC effectively
45 avoids the outward local buckling (OLB) for the local yielding of the steel tube under large loads or
46 at large lateral deformation (Tomii et al. 1985a, 1985b, Sakino et al. 2004), which usually occurs in
47 CFST elements. This is also because the steel tube is designed not to carry directly axial loads in
48 STCC elements via the termination of the steel tube at its two ends. Besides, the STCCs provide a

49 solution to overcome the difficulty of the load transfer mechanisms and the detailing design at RC
50 beam-to-CFST column joint nowadays. Up-to-date, a number of studies have been conducted to
51 understand the constitutive behaviour (Binici 2005, Li et al. 2005) and structural behaviour of STCCs
52 under various loads (Aboutaha and Machado 1999). In particular, Han et al. (2005) experimentally
53 investigated the monotonic and cyclic behaviours of STCC columns, thin-walled STCC column to
54 beam joints (Han et al. 2009), and thin-walled STCC columns subjected to axial local compression
55 (Han et al. 2008). Zhou and Liu (2010) experimentally studied the seismic behaviour and shear
56 strength of STCC short columns, the performance of STCC columns under eccentric compression
57 (Zhou et al. 2015, Zhou et al. 2016), the behaviour of circle STCC column-to-RC beam connections
58 under axial compression (Zhou et al. 2017). In addition, Yu et al. (2010) proposed a finite element
59 method (FEM) analysis model to analyse the mechanisms of STCC columns under axial compression.
60 However, similar to the buckling of the steel tube in CFSTs at large deformation and its corrosion
61 under aggressive environment limit their application in civil engineering, the corrosion of the steel
62 tube also obstructs the application of the STCCs in an increasing deteriorative built environment.
63 According to literature (Wu et al. 2014, Liu et al. 2018), the FRP wrapping of the STCC solves the
64 durability concerns of the STCC structures. However, a few concerns regarding this kind of structural
65 elements still need to be addressed such as low longitudinal stiffness and relatively high construction
66 cost. Therefore, with consideration of these reasons, a FRP-steel confined RC element has been
67 developed. The first author's research group (Ran 2014, Huang 2016) investigated the constitutive
68 behaviour of GFRP-STCC under monotonic and cyclic axial loads. Cao et al. (2017) experimentally
69 investigated the behaviour of FRP-STCC stub columns with expansive self-consolidating concrete
70 under axial compression. Liu et al. (2018) studied the axial behaviour of circular CFRP-STCC stub
71 columns. In summary, comparing with STCC and FRP-confined concrete structures, the FRP-STCC
72 structures are more durable and flexible because of the using of durable FRP materials and a more
73 effective confinement.

74 On the other hand, CFST elements are popular in high-rise buildings or piers in Europe and Japan as
75 reinforced concrete is widely applied. This is due to the reasonable arrangement of steel and concrete
76 in the section, which optimizes the sectional strength and stiffness of the elements leading to an
77 effective use of the material properties to resist the tension and bending actions in the section.
78 Meanwhile, the tube can serve as a part of formwork in construction, which decreases labour and
79 material costs. However, the effects of the bond, confinement, and OLB on CFST's structural
80 behaviour are under study to facilitate the development of design methods of the members under
81 lateral reversed cyclic loads. External FRP confining may be a potential solution to fix the OLB
82 problem of CFST elements (Xiao 2004, Hu et al. 2011) for the high strength and elastic properties of
83 FRP materials, but which is still under research. Xiao (2004) proposed the FRP-confined CFST
84 columns, who also compared and commented the FRP-STCC and CFST elements. He concluded that
85 a FRP-confined CFST column combines the advantages of the conventional CFST column and the
86 tubed column, in which additional transverse reinforcement is designed for the potential plastic hinge
87 regions to improve the seismic performance of the elements. In 2005, Xiao et al. (2005) performed a
88 study to introduce and experimentally validate FRP-confined CFST columns under axial and seismic
89 loads and confirmed the excellent seismic performance of these columns. Recently, several studies
90 were reported to examine the constitutive behaviour of FRP-confined CFST columns (Xiao et al.
91 2005, Liu and Lu 2010, Park et al. 2010, Tao et al. 2011, Lin 2012, Teng et al. 2013, Park and Choi
92 2013, Hu and Seracino 2013, Wang et al. 2015, Yu et al. 2016), but more studies are underway to
93 examine details of the elements.

94 Concerning the structural behaviour of FRP-STCC elements under various loads, up to present, there
95 are only limited studies available in literature. Most of the studies focused on the behaviour of the
96 elements under axial compressive loads (Cao et al. 2017, Liu et al. 2018). Therefore, the major
97 objective of this paper is to study the behaviour of circular GFRP-STCC columns under combined
98 constant axial loads and lateral reversed cyclic loads. Based on experimental observations and
99 analyses of the deformation mechanisms, this paper also proposes a FEM analysis model to simulate
100 the structural response under the combined loads. Moreover, this study also aims to discuss the effect

101 of the main structural design factors on the behaviour of FRP-STCC columns under reversed cyclic
102 loads.

103 **2. Experimental program**

104 **2.1 Test overview**

105 In this experiment, eight circular sectional concrete columns were designed and prepared, including
106 one reinforced concrete (RC) column, one steel tube-confined RC column, one steel tube-confined
107 steel reinforced concrete (SRC) column, one CFRP-steel confined RC column, two GFRP-steel
108 confined RC columns and two GFRP-steel confined SRC columns. The core concrete diameter of all
109 specimens was 300 mm and the thickness of the concrete cover was 30 mm. The height of the columns
110 was 1350 mm with a 300 mm high column head. The dimension details and steel arrangement of the
111 specimens are presented in Fig. 2. The volumetric ratio of longitudinal steel bar of all specimens was
112 1.71%, and the stirrup volumetric ratio was 0.6%. For the steel tubes confined specimens, the
113 thickness of the steel tubes was 3.0 mm. In order to prevent the direct axial compression of the steel
114 tubes, 20 mm gaps were set at both ends of the columns. In FRP confined specimens, FRP was used
115 to confine the hinge zone of 500 mm with different layers depending on the test design, while the
116 remaining parts of the columns were wrapped by 2-layers same-type FRP sheet. For the confined
117 SRC columns, a standard H-section steel (150mm×150mm×10mm×7mm) was set from underneath
118 the base beam to the top of the column. Table 1 and Fig.2 (a) show the details of test specimens.

119 **2.2 Specimen manufacture**

120 All steel tubes in the study were manufactured from 3.0 mm steel plates by welding at their lap zone.
121 The tested specimens were prepared following the steps: (1) setting of the reinforcement cage of
122 columns and base beam; (2) setting of the steel tube (its welding line was placed on the plane oriented
123 parallel to the column's axis of symmetry); (3) setting of the reinforcement cage and module of the
124 stigma (column head); (4) curing of the specimens; and (5) removing steel tube for concrete columns
125 or wrapping FRP sheet for FRP-steel confined concrete columns. The key steps of FRP wrapping
126 were as follows: (1) polishing their surface with an angle grinder to enhance its surface roughness;

127 (2) clearing the surface of the steel tubes such as wiping them with alcohol; and (3) setting of FRP
128 sheet. The overlap length of FRP wrapping was about 300 mm and the welding line of the steel tube
129 was located in the middle of the overlap zone of FRP wrapping to prevent the cracking of welding
130 line. Fig. 2(b) shows a completely GFRP-steel confined column specimen.

131 **2.3 Materials' properties**

132 Two kinds of unidirectional FRP sheets were used, i.e. GFRP sheet L900 (900 g/m^2) and CFRP sheet
133 UT70-30 (300 g/m^2). A construction impregnation adhesive for structural application, an epoxy
134 adhesive Lica-100 was used, whose properties are listed in Table 2. Ready-mixed concretes were
135 used, which contained 5-10mm aggregates with a target compressive strength of 40 MPa. According
136 to the test results of six standard concrete cubes ($150\text{mm}\times 150\text{mm}\times 150\text{mm}$), the cube compressive
137 strength of concrete was 41.2 MPa, which is approximately transferred as a concrete cylinder'
138 compressive strength via multiplying by 0.8 for normal strength concrete. The transverse and
139 longitudinal reinforcements of the columns are 8mm plain (smooth) steel rebars and 16mm deformed
140 steel rebars, respectively. Q235 steel tube (3.0 mm thickness) was used to confine the columns, whose
141 properties are listed in Table 2 obtained by the standard test method, GB/T228-2010 (2009). As shown
142 in Fig. 2, a standard H-section steel ($150\text{mm}\times 150\text{mm}\times 10\text{mm}\times 7\text{mm}$) was used in the tested SRC
143 columns.

144 **2.4 Test setup and measurement**

145 The details of the test setup are illustrated in Fig. 3. The bottom base beam of each specimen was
146 firstly anchored on a strong RC floor through several high strength steel bolts. At the ends of the
147 beam, two linear variable differential transducers (LVDTs) were used to record its possible slipping
148 during the test. The constant axial loads were applied on the top of the columns by a hydraulic jack
149 with a maximum capacity of 1000 kN, as shown in Fig. 3. The reversed lateral cyclic load was applied
150 at the column head using a hydraulic jack with a maximum capacity of 1000 kN with a one-way steel
151 hinge device that can rotate around the vertical and horizontal loading directions. The applied axial
152 load in each column was designed as 978 kN for RC columns and 1242 kN for SRC columns - about

153 35% of the nominal axial load capacity (N) of the columns obtained as per the Chinese standards (GB
154 50010-2010 2015, TGJ3-2002 2002).

155 During the tests, the lateral load and displacement of the columns were monitored by using one load
156 cell and several LVDTs (450 mm, 600 mm, and 750 mm from the top of the base beam), while the
157 strains of the longitudinal reinforcement, the stirrup, FRP-steel tube and steel tube during the loading
158 were investigated through several gauges. Four strain gauges (L1~L4) and three hoop strain gauges
159 (H1~H3) were installed on the longitudinal rebars and on the stirrups at a distance of about 10mm
160 from the top of the base beam, respectively. Two hoop strain gauges (HN, HS) and three vertical
161 strain gauges (LN, LS, and LM) were arranged respectively on the surface of the steel tube or the
162 FRP tube at the distances of 70 mm, 220 mm, and 370 mm from the top of the base beam, in order to
163 measure the horizontal and vertical strains of the steel tube or the FRP tube.

164 **2.5 Loading methods**

165 It is necessary to establish a reasonable loading history to capture the critical issues of the resistance
166 and deformation on structural elements during the quasi-static cyclic loading tests. After the
167 application of a constant axial load on top of the columns, a multiple reversed cyclic lateral loading
168 was performed in each column. In the reference column, a deformation-controlled reversed cyclic
169 lateral loading was applied with an increment of 4.0 mm. The target deformation of the first cyclic
170 loading was 4.0 mm. When the lateral displacement arrived at 12mm, the lateral loading was repeated
171 twice at each target cycle of lateral loading. A similar loading method was performed at the confined
172 concrete columns, except for that the increment of lateral deformation was set as 8.0 mm after the
173 lateral displacement of the columns exceeded 16mm. For the security, the tests were finished if the
174 lateral resistance force of the specimen reduced to 60% of its maximum measured value or the lateral
175 displacement of the columns is too large such as over 100mm. Fig. 4 presents the loading procedure
176 applied in the columns.

177 **3. Test observations**

178 **3.1 Cracking evolution and damages**

179 **(1) RC column and steel tube confined RC column (G0S0T0 and G0S1T0)**

180 In Specimen G0S0T0, the first horizontal crack occurred at the north side of the column about 100
181 mm from the top of the base beam. Then, a semi-circular horizontal crack appeared on the south side
182 with a height of 100 mm. At the same time, a second crack appeared at a north side of the column, at
183 a height of 200 mm. Meanwhile, horizontal cracks began to appear in the upper part and in the middle
184 of the south side and began to develop to the north side of the column. Next, new horizontal cracks
185 appeared in the columns about 400 mm and 600 mm from the top of the base beam. With the increase
186 of the lateral displacements, the cracks below the south side developed, while the horizontal cracks
187 continued to develop, and crushing of the concrete at the south side of columns occurred. At this time,
188 the first vertical crack was confirmed in the south side concrete along with the crushing of the concrete
189 on the north side. Next, at the north side of the concrete first vertical cracks appeared. When the lateral
190 displacement was about 24 mm, the concrete cover on the north side shows a large area of spalling
191 but a buckling of the longitudinal reinforcing bar could not be observed. All the damages and cracks
192 in the column were mainly caused by the plastic deformation of concrete and internal damage
193 surrounding the deformed reinforcements. The final failure morphology of the specimen is shown in
194 Fig. 5.

195 In the steel tube confined RC column, G0S1T0, the early stage cracks cannot be visually observed
196 due to the external steel tube. When the lateral displacement was 48mm, the cracking and the
197 extrusion exfoliation of concrete were found at the bottom of the column. After removing the steel
198 tube at the end of the column, the concrete at the bottom of the confined zone was crushed, but due
199 to the constraints of the steel tube, it did not fall off. Several slipped shear cracks were also found at
200 the foot of the column. All of damages and cracks were still caused by the plastic deformation of the
201 elements, however, the confinement of steel tube effectively reduces the crushing of the concrete
202 which indicates the failure of the column will be difference with that of RC columns in which the
203 sectional concrete crushing is one of main reasons of structural failure.

204 **(2) FRP-steel confined RC columns (G5S1T0, G7S1T0 and C7S1T0)**

205 Specimen G5S1T0 presented a large residual displacement after testing. At the surface of GFRP tube
206 wrapped in the column foot, the resin slightly cracked. After removing of the GFRP wrapping and
207 steel tube, several cracks were found at the column foot and the south side of the column. This can
208 be explained by the fact that the compression from the upper part of the north side GFRP-steel
209 confined concrete promotes the crushing to the below concrete (about 50 mm from the top of the base
210 beam). However, the damage of the outermost layer of GFRP tube did not appear during testing.
211 Compared to Specimen G5S1T0, two more layers of GFRP sheets were applied in Specimen G7S1T0,
212 but the failure mode of the two specimens is similar. When the lateral displacement was too large, the
213 concrete at the top of the base beam was disintegrated. By removing the GFRP tube and steel tube
214 after testing, several horizontal and diagonal cracks were observed at the distance of 100 mm from
215 the top of the base beam. However, the confinement of the GFRP was able to protect the core concrete
216 in a satisfactory manner. Comparing with Specimen G7S1T0, when GFRP was replaced by CFRP,
217 similar failure mode, cracking pattern, and damages were found in Specimen C7S1T0, so that it can
218 be stated that the confinement of the columns were performant. In summary, the main damages and
219 cracks of FRP-steel confined RC columns concentrated on the critical section between the column
220 and the base beam, which were expressed as crushing and slipped cracks, respectively.

221 **(3) FRP-steel confined SRC columns (G0S1T1, G5S1T1 and G7S1T1)**

222 The cracks and damages of the steel tube confined SRC column G0S1T1 were similar to that of the
223 steel tube confined RC column G0S1T0. When the lateral displacement increased to about 48mm, the
224 parts of the concrete on the top of the base beam and the column foot were cracked and damaged as
225 the steel tube deformation and stretched continuously. At the end of the test, there was no apparent
226 buckling or other failure characteristics visible on the steel tube. When removing the steel tube later,
227 a horizontal crack was observed at about 80 mm near the column foot but no other damages to the
228 column body. When the steel tube was confined by GFRP tube such as Specimen G5S1T1, the cracks
229 appeared on the south side of the column above the base beam when the lateral displacement of the
230 column was 25mm. These cracks developed further into compressive damage of the concrete cover.

231 At the end of the experiment, however, the confined concrete is still almost intact. Comparing with
232 the case of Specimen G5S1T1, the cracks and damages were controlled well when using more layers
233 of GFRP sheets in G7S1T1. However, the failure mode of this specimen was similar to that of
234 Specimen G5S1T1. In the case of large displacement, the concrete at the top of the base beam was
235 initially disintegrated, before being damaged near the top of the column. At last, the concrete was
236 damaged at around 10 mm over the base beam, while the confined concrete remained protected
237 without visual horizontal or diagonal cracks. In summary, the damages and cracks in the confined
238 SRC columns were much smaller than those of the other columns, which is attributed to the
239 reinforcement of the strong H-sectional steel inside.

240 **3.2 Hysteresis behaviour**

241 **(1) RC and steel tube confined RC columns (G0S0T0 and G0S1T0)**

242 Regarding the RC column, the lateral load-displacement curve is almost linear at the initial stage of
243 loading. At the second cycle of the same target deformation, the stiffness and lateral load-bearing
244 capacity of the specimen hardly degraded. However, the residual deformation became larger and the
245 unloading stiffness and bearing capacity decreased with the increase of the lateral displacement, but
246 the pinch contraction phenomenon of the hysteresis hoops was not obvious. When the displacement
247 was 24 mm, the test was stopped due to the large area of concrete spalling. At this moment, the lateral
248 load was 73.4% of the axial peak load of the column. For specimen G0S1T0, the residual deformation
249 during unloading was small at the beginning. The stiffness and the bearing capacity of the specimen
250 at the early stage are not significantly decreased at the same deformation level. As shown in Fig. 6,
251 the hysteretic pinch phenomenon was also not obvious in this column showing that it has a strong
252 energy dissipation capacity. When the lateral displacement was 72mm, the lateral load decreased to
253 62% of its peak load.

254 **(2) FRP-steel confined RC columns (G5S1T0, G7S1T0 and C7S1T0)**

255 Regarding specimen G5S1T0, the lateral load and stiffness of the specimen have not changed and its
256 residual deformation was small at the initial stage. However, as shown in Fig. 6, with the increase of

257 lateral displacement, the hysteresis loop appears an obvious pinch and shrink phenomenon, but the
258 shape of the loop is still fat. The bearing capacity of the column did not decrease rapidly after reaching
259 the peak load indicating that the ductility of the column was satisfactory. For specimen G7S1T0, the
260 shape and variation of the hysteresis curve were very similar to that of G5S1T0, however, the
261 hysteresis loop of the G7S1T0 was fatter. For specimen C7S1T0, its residual deformation was small
262 while the stiffness and bearing capacity had almost no degradation when the displacement was small.
263 As the displacement increased, the residual deformation of the specimen increased, and the stiffness
264 and bearing capacity decreased obviously.

265 (3) FRP-steel confined SRC columns (G0S1T1, G5S1T1 and G7S1T1)

266 As it can be seen from Fig. 6, G0S1T1 specimen shows a fusiform hysteresis loop at the initial stage,
267 while the hysteresis curve is gradually getting fatter with the increase of the displacement and shows
268 no sign for the pinch-and-shrink phenomenon. This demonstrates that the column possesses an
269 excellent energy dissipation ability. For specimen G5S1T1, its bearing capacity and stiffness did not
270 significantly change under the same displacement. With the increase of loading, the shape of the
271 hysteresis loop tended to become fatter. The degradation rate of the lateral load was small after the
272 column reached its peak load meaning that the column has a satisfactory ductility. For specimen
273 G7S1T1, the residual deformation of the column during the initial loading was quite small. Similar
274 to that of G5S1T1, no obvious degradation occurred in the stiffness and lateral load of the specimen
275 at the same level of lateral displacement. With the increase of lateral displacement largely, the
276 hysteresis curve of the specimen become fatter showing its strong energy dissipation capacity.
277 Comparing between G7S1T1 and G5S1T1, no significant difference was observed in G7S1T1
278 indicating that increasing the number of GFRP layers has no influence on the seismic performance of
279 the SRC columns.

280 3.3 Strain evolution of reinforcing rebars and steel tube

281 Fig. 7 demonstrates that when the lateral load increases, the strain of the steel rebars increases as the
282 lateral displacement of RC column and steel tube confined RC columns. When the displacement was

283 32 mm, the longitudinal reinforcement in L2 has a strain of higher than its yielding strain, i.e. $2000\mu\epsilon$.
284 With the increase of the lateral displacement, the longitudinal reinforcement begins to yield. However,
285 the maximum compression strain of the longitudinal reinforcement reached $2500\mu\epsilon$ at the later
286 loading stage indicating that it did not undergo significant plastic deformation. The figure shows that
287 the stirrups can confine the concrete well in the circular RC column.

288 As shown in Fig. 7, taking specimen G7S1T0 as an example with the FRP-steel confined RC columns,
289 the maximum strains of the steel tube occurred at the top of the base beam in both sides are $6602\mu\epsilon$
290 and $3543\mu\epsilon$ - both exceeding the yielding strain of the tube. The hoop strain on the outside tube
291 confirmed that the steel tube were in tensile. Similar to the variation law of longitudinal strain, the
292 amplitudes of HN50 and HS50 close to the top of the base beam were $4883\mu\epsilon$ and $4883\mu\epsilon$,
293 respectively. Specimen G0S1T1 shown a similar strain evolution to Specimen G7S1T0. For FRP-
294 steel confined SRC column G5S1T1, the strains of LN50 and LS50 near the base beam were $6823\mu\epsilon$
295 and $5949\mu\epsilon$, respectively. All the results of strain gauges indicated the steel hoop were under tension.
296 This is due to the expansion of the core concrete after multiple lateral reserved loads leading to an
297 increase in the deformation of steel tube confined by GFRP sheet. At the same time, HN50 and HS50
298 located on the south and north sides were $6755\mu\epsilon$ and $4799\mu\epsilon$, respectively which reached its yielding
299 status. In summary, in the FRP-steel confined SRC columns, at the same section of the column foot,
300 the strain on the north side, the south side, and the neutral axis were all different, which means that
301 the hoop strain distribution was not uniform. The strain of the steel tube in the confined SRC columns
302 was smaller than that of other specimens because the sectional rigidity of the SRC column is quite
303 large for the using of H-section steel.

304 **4. Comparison and analyses**

305 **4.1 Comparison of hysteresis behaviour**

306 Fig. 8 compares the hysteresis curves of all the tested specimens. Results show that the bearing
307 capacity and ductility behaviour of specimen G0S1T0 was better than that of the specimen G0S0T0

308 owing to the external lateral confinement of steel tube. Comparing to Specimen G0S1T0, an overall
309 improved bearing capacity, ductility, and energy dissipation capacity of the steel tube confined RC
310 column was obtained by the GFRP wrapping, such as the specimens G5S1T0 and G7S1T0.
311 Furthermore, with the increase of the number of layers of FRP sheet, the enhancement effect of GFRP
312 wrapping was more obvious.

313 Examining the case of the specimens G5S1T0 and G7S1T0, the seismic performance of the FRP-steel
314 confined RC columns was improved with the number of layers of FRP sheet, but the enhancement
315 effectiveness became lower with the number of FRP layers. For the specimens G7S1T0 and C7S1T0,
316 although the lateral confinement (both the lateral confinement stiffness and strength) of the CFRP
317 was stronger than that of the GFRP, the load-carrying of the specimen G7S1T0 is slightly better than
318 the specimen C7S1T0. This can be explained as follows: (a) the failure mode of the confined RC
319 columns was controlled by the damages and cracks in the confined RC, but not controlled by the
320 rupture of the FRP wrapping usually occurred in axial compressive columns, which indicated that the
321 FRP material were not fully utilized; (b) this little abnormal case may be induced by the manufacture
322 error of the specimens, and testing error etc.

323 For GFRP-steel confined RC/SRC columns, it was observed that the bearing and deformation
324 capacities of the specimen G5S1T1 (or G5S1T0) were improved when using GFRP to confine steel
325 tube, comparing with the ones of specimen G0S1T1 (or G0S1T0). This indicates that the FRP-steel
326 composite tube can improve the seismic performance of the RC/SRC columns in an effective manner.
327 However, when the used amount of steel reinforcement (H-section steel, steel reinforcing bars, and
328 steel tube) was high, the improvement caused by FRP wrapping became not obvious. For the
329 specimens G5S1T1 and G7S1T1, the increase of the number of layers of FRP did not improve
330 significantly the shear-resistance and the deformation capacity of the confined SRC columns. This
331 could be explained by the fact that the confined columns using H-section steel already have a high
332 seismic performance indicating that the confinement effectiveness from FRP sheets was not
333 developed.

334 4.2 Skeleton curves-deformation and ductility

335 Skeleton curves can clearly reflect the bearing capacity and ductility of RC members which are the
336 main considerations of the seismic design of the members. Generally, a skeleton curve mainly
337 includes three characteristic points: yield strength point, peak strength point, and ultimate strength
338 point. The peak point is the peak load of the columns, P_{max} . For the FRP-steel confined RC columns,
339 the ultimate point is the point at 85% of the peak load ($85\% P_{max}$), P_u . The deformability of FRP-steel
340 confined SRC columns was excellent; however, the ultimate deformation was large when the lateral
341 load drop is not obvious. Due to safety reasons, all tests were stopped before reaching the ultimate
342 state of the columns. For a comparative analysis, the ultimate strength points of two FRP-steel
343 confined SRC columns (Specimens G5S1T1 and G7S1T1) were considered as a point when the lateral
344 load drops to 90% of its peak load in this study.

345 There is no uniform the calculation method to adjust the yield point of the concrete element. In this
346 paper, the equivalent elastoplastic energy absorption method (Park 1988) was applied to define the
347 yielding point by introducing an additional line in the load-deformation curve such as to define an
348 equivalent elastoplastic displacement with the same energy dissipating, as shown in Fig. 9: the
349 trapezoidal OABC area is equal to the area encircled by the curve ODBCO. In this figure, Δ_u and P_u
350 represent the ultimate displacement and the ultimate load, respectively; P_y and Δ_y are the yield load
351 and displacement, respectively. P_{max} is the peak load and Δ_{max} is the corresponding displacement. P_u
352 is taken as $85\%P_{max}$ or $90\%P_{max}$ depending on columns with/without H-section steel with the
353 exception of Specimen G0S1T1 ($85\%P_{max}$). R is the drift angle of the columns.

354 Fig. 10 shows the comparison of the skeleton curves of all the tested specimens and Table 3 presents
355 a summary of all test results. The yield loads of FRP-steel confined RC columns without H-section
356 steel increased slightly with the number of layers of FRP wrapping. The yield displacement for the
357 steel tube confined or FRP-steel confined RC columns was larger than that of RC columns. Compared
358 to Specimen G0S1T0, G5S1T0 and G7S1T0 have a larger yield load which increased by 5.6% and
359 11.0%, respectively. The peak loads of the specimens G5S1T0 and G7S1T0 increased by 10.2% and
360 16.0%, respectively, while their peak displacements increased by 14.9% and 28.4%, respectively, and

361 their ductility coefficients increased by only 0.5% and 3.1%, respectively. This indicates that the
362 ultimate shear capacity and deformation capacity of the steel tube confined RC column were
363 significantly improved after confinement by FRP wrapping, while no significant improvement was
364 achieved for its ductility. On the other hand, CFRP-steel confined specimen (C7S1T0) had a better
365 ductile coefficient which was higher than that of GFRP-steel confined specimen (G7S1T0) because
366 the confinement of the CFRP was stronger than that of the GFRP, as the same number of layers of
367 FRP was used.

368 With regard to the specimens using H-section steel, similar results were obtained. Comparing to the
369 specimens G0S1T1, with an increase of the number of GFRP layers, the yielding load of the
370 specimens G5S1T1 and G7S1T1 increased slightly by 0.3% and 10.2%, their peak load increased by
371 8.8% and 17.9% and their ultimate displacement increased by 7.1% and 12.9%, respectively.
372 Meanwhile, the ductility coefficients of the G5S1T1 and the G7S1T1 also increased slightly with
373 increasing the number of GFRP layers.

374

375 **4.3 Stiffness degradation**

376 The lateral stiffness of RC columns generally degrades under a reversed cyclic loading for several
377 reasons such as the decreasing of effective compression area of columns caused by concrete cracking
378 and the yielding of steel reinforcement etc. The stiffness in this study refers to an equivalent lateral
379 stiffness, which is the average value of the load-displacement ratios at the unloading points in the
380 positive and negative directions of the first loading hoop of each target displacement level. Fig. 11
381 demonstrates the stiffness degradation curve of all specimens. Results show that the initial stiffness
382 of the RC column (G0S0T0) is low, while the members confined by steel tube or FRP-steel tube have
383 a much higher stiffness. As the lateral displacement increases, the stiffness of the confined RC
384 columns degraded slowly. In addition, the stiffness degraded more slowly when the number of GFRP
385 layers increased. The initial stiffness of specimens G0S1T1, G5S1T1, and G7S1T1 are almost the
386 same due to all SRC columns have a strong stiffness. As the lateral displacement increased

387 continuously, the degradation rates of the lateral stiffness of the SRC specimens remained an almost
388 identical value.

389 **4.4 Energy dissipation capacity**

390 The energy dissipation capacity of RC elements is an important index to evaluate their capacity to
391 absorb earthquake energy induced by ground shaking. The failure and collapse of RC structures could
392 happen due to poor energy dissipation during an earthquake. In this study, the cumulative energy
393 dissipation was calculated considering only the first load hoop at the corresponding displacement
394 level. As shown in Fig. 12, the accumulated energy dissipation of RC columns is less than that of the
395 confined RC columns at the same lateral displacement. As the number of GFRP layers increased, the
396 energy dissipation capacity of the confined columns increased. However, the accumulated energy
397 dissipation of the G7S1T0 was only slightly higher than that of the G5S1T0. This is because the
398 specimen G5S1T0 wrapped with 5 layers of GFRP may be already under an over-confining state.
399 Therefore, the effect of increasing GFRP layers on energy dissipation may be small in G7S1T0.
400 Similarly, the specimen C7S1T0 got a greatly improved energy dissipation capacity comparing to the
401 specimen G0S0T0, but when comparing to the specimens G7S1T0 and G5S1T0, their energy
402 consumption capacity was almost the same.

403 For the SRC columns (G0S1T1, G5S1T1, and G7S1T1), similar behaviour was obtained: (1) in the
404 initial stage, the accumulated energy dissipation of the specimens was similar for all the specimens;
405 (2) as the lateral displacement increased, the energy dissipation capacity of the columns increased and
406 shown a different evolution and finally the energy consumption of the G7S1T1 is highest; and (3) the
407 number of GFRP layers has no significant influence on the energy dissipation capacity of the SRC
408 columns. This again shows that the improvement of the seismic performance of the SRC columns due
409 to an increasing the number of layers of GFRP sheet is relatively small.

410 **5. FEM simulation of FRP-steel confined RC columns**

411 According to Section 4, the GFRP wrapping did not present its positive effect on the seismic
412 performance of the SRC columns. The main reason could be that the core SRC column possessed

413 already a high stiffness to the lateral deformation under the reversed cyclic loads. Therefore, in this
 414 section, the paper emphasizes on the simulation of FRP-steel confined RC columns. OpenSees
 415 (Mazzoni et al. 2006), as an open source object-oriented software, is used for the analysis of the tested
 416 RC and FRP-steel confined RC columns. The basic assumptions for the analyses of the columns
 417 include: (a) concrete section remained a plane and normal to the neutral axis after bending, (b) the
 418 slippage between steel rebar and concrete was neglected to simplify the simulation, and (c) the shear
 419 effect was neglected to simplify the simulation due to the fact that the shear span ratios of all columns
 420 in this FEM is not less than 2 (especially most case is 4), which indicated the flexural failure mode
 421 will occur in the columns and the shear effect would be relatively small. In the following sections,
 422 the geometric and materials models used in the program are discussed.

423 5.1 Material model and cross-section rule

424 5.1.1 Concrete and steel tube confined concrete

425 For the RC column, a three-line constitutive model proposed first by Kent and Park (1971) and
 426 modified by Scoot et al. (1982) was selected as a backbone curve for concrete material. The backbone
 427 and hysteresis model of concrete (uniaxial materials of Concrete01 in OpenSees) are presented in Fig.
 428 13 (Mazzoni et al. 2006). The related equations of the model are as follows:

$$429 \quad f = \begin{cases} Kf_{co} \left[2 \left(\frac{\varepsilon}{\varepsilon_{cc}} \right) - \left(\frac{\varepsilon}{\varepsilon_{cc}} \right)^2 \right], \varepsilon \leq \varepsilon_{cc} \\ Kf_{co} \left[1 - Z \left(\frac{\varepsilon}{\varepsilon_{cc}} \right) \right], \varepsilon_{cc} \leq \varepsilon \leq \varepsilon_{cu} \\ 0.2Kf_{co}, \varepsilon \geq \varepsilon_{cu} \end{cases} \quad (1)$$

430 In the equation,

$$431 \quad K = 1 + \rho_v f_{yh} / f_{co} \quad (2)$$

$$Z = \frac{0.5}{\frac{3 + 0.29 f_{co}}{145 f_{co} - 1000} + 0.75 \rho_v \sqrt{\frac{b}{s}} - 0.002K} \quad (3)$$

432 Where, ε_{cc} is the strain corresponding to the peak stress of the confined concrete, taken as 0.002K; K
 433 is the coefficient of the increase of the peak load caused by the confinement. Z is the slope of the
 434 strain drop curve; f_{co} is the compressive strength of standard non-confined concrete cylinders; f_{yh} is
 435 the yield strength of stirrups; ρ_v is the volumetric reinforcement ratio of stirrups; b is the width of core
 436 concrete; s is the spacing of stirrup. For steel tube confined RC columns, the analysis of the confined
 437 concrete of the columns adopted the constitutive model of steel tube confined concrete proposed by
 438 Lin (2012).
 439

440 **5.1.2 FRP-steel confined concrete model**

441 **a. Monotonic model**

442 An analysis-oriented stress-strain model for FRP-steel confined concrete was used in this paper.
 443 Referring to analysis-oriented models for FRP-confined concrete (Jiang et al. 2007), a passive
 444 confining stress-strain model for FRP confined concrete in FRP-steel confined concrete columns can
 445 be achieved from an active confining model for concrete through an incremental approach. The model
 446 is proposed on the assumption that the axial stress and strain of FRP confined concrete at a given
 447 hoop strain are the same as those of the same concrete confined actively with a constant confining
 448 pressure equalling to that provided by the FRP wrapping (Jiang et al. 2007). The following axial
 449 stress-strain model for concrete, which was built by Popovics (1973), is adopted in this paper.
 450 Popovics (1973) proposed a stress-strain model for the confined concrete with an active confining,
 451 which presents a great analysis accuracy. Thus, this study suggests to use it to analyse the stress-strain
 452 of GFRP-steel confined concrete elements, which is given as:

$$\frac{\sigma_c}{f_{co}} = \frac{(\varepsilon_c / \varepsilon_{cc}) \cdot r}{r - 1 + (\varepsilon_c / \varepsilon_{cc})^r} \quad (4)$$

$$r = \frac{E_c}{E_c - f_{cc} / \varepsilon_{cc}} \quad (5)$$

455 Based on the research conducted by the research group of the first author of the paper (Lin 2012, Ran
 456 2014, Huang 2016), the study suggests to consider the active (stirrups and steel tube) and passive
 457 confining actions (FRP wrapping) in FRP-steel confined concrete columns to model the peak axial
 458 stress and the corresponding axial strain of FRP-steel confined concrete. The proposed models are
 459 expressed as:

$$460 \quad \frac{f_{cc}}{f_{co}} = 1 + 4.08 \left(\frac{f_{lf}}{f_{co}} \right)^{1.28} + 5.5 \left(\frac{f_{ls} + f_{lh}}{f_{co}} \right)^{0.86} \quad (6)$$

$$461 \quad \frac{\varepsilon_{cc}}{\varepsilon_{co}} = 2 + 11.72 \left(\frac{f_{lf}}{f_{co}} \right)^{0.55} + 5.8 \left(\frac{f_{ls} + f_{lh}}{f_{co}} \right) \quad (7)$$

462 Referring to the confining mechanism of FRP confined CFST elements proposed by Hu (2011), in
 463 this study, the relationship between hoop strain (ε_h) and axial strain of confined concrete is calculated
 464 as:

$$465 \quad \frac{\varepsilon_{cc}}{\varepsilon_{co}} + 0.66 \left(1 + 8 \frac{f_1}{f_{co}} \right) \times \left\{ \left[1 + 0.75 \left(\frac{\varepsilon_h}{\varepsilon_{co}} \right) \right]^{0.7} - \exp \left[-7 \left(\frac{\varepsilon_h}{\varepsilon_{co}} \right) \right] \right\} = 0 \quad (8)$$

466 In the equations, f_{cc} is the compressive stress of confined concrete; f_{ls} , f_{lf} and f_{lh} are the confining
 467 stresses of steel tube, FRP and stirrups, respectively; f_1 is the total confining pressure; E_c is the elastic
 468 modulus of concrete, which is taken as $4736f_{co}^{0.5}$; ε_{cc} is the axial strain of confined concrete at its
 469 strength; σ_c is the axial stress of tested concrete specimen; ε_{co} is the axial strain of concrete at its
 470 strength; ε_c is the unit strain of concrete corresponding to σ_c .

471 As an analysis-oriented stress-strain model, the generation of the axial stress-strain curves for FRP-
 472 steel confined concrete would be achieved by an incremental process, which was introduced detailed
 473 in literature studied by the research group of the first author of the paper (Huang 2016).

474 **b. Multi-cycle model**

475 The cyclic constitutive model includes mainly the skeleton model and hysteretic law. The latter has
 476 two key unloading and reloading paths, and the calculation of plastic strain and stress degradation.

477 Here, the monotonic model proposed above is used to simulate the skeleton curve of the FRP-steel
478 confined RC columns under cyclic loading. For the hysteretic models, considering the fact that the
479 strength ratio of the FRP materials to steel is fairly large, the confining effectiveness of FRP-steel
480 tube to the concrete is considered similar to that of the FRP-confined concrete. Meanwhile, due to the
481 existence of the steel tube and transverse rebars in the FRP-steel confined RC columns, the authors
482 suggest to use an improved model proposed by Lam and Teng (2009). The key features and related
483 equations are presented in Fig. 14. The details of the multi-cyclic model are reached in the reference
484 (Huang 2016).

485 **5.1.3 *A new material constitutive model for FRP-steel confined concrete developed with*** 486 ***an OpenSees Programming***

487 An accurate material constitutive model is the base of the analysis of the RC columns subjected to
488 reversed cyclic loads. OpenSees is a well-known open source platform with a strong nonlinear
489 structural analysis and a high compatibility. FRP-steel confined concrete can significantly improve
490 the seismic behavior of the RC columns as demonstrated in Section 4 of the paper. However, the
491 existing material constitutive models for FRP-steel confined concrete are not available in the current
492 version of OpenSees. By the C++ programming language, a new user-defined material constitutive
493 model based on the monotonic and multi-cycle constitutive model proposed in Section 5.1.2 was
494 developed, and applied into an OpenSees platform. The developed new material constitutive model
495 is suitable for FRP-steel confined concrete in circular section. The material models and elements are
496 separate and independent in OpenSees. Therefore, all existing elements in OpenSees can be
497 compatible with the new material model. Compared with the existing concrete model, the new
498 developed material model can accurately simulate the true stress-strain relationship of FRP-steel
499 confined concrete, especially the unloading rules including residual strain, which would improve the
500 pinching effect of FRP-steel confined RC columns.

501

502 **5.1.4 *Steel model***

503 In this study, a constitutive model of steel reinforcement proposed by Menegotto and Pinto (1973)
504 was used considering steel reinforcement as an elastic-perfectly-plastic material, which is given as:

$$505 \quad \sigma^* = b\varepsilon^* + \frac{(1-b)\varepsilon^*}{(1+\varepsilon^{*R})^{1/R}} \quad (9)$$

506 where, b is strain hardening coefficient; σ^* and ε^* are normalized stress and strain. R is a curvature
507 parameter. The detailed calculations of the parameters are available in the references (Menegotto and
508 Pinto 1973, Orakcal et al.2006). Fig. 15 depicts a typical hysteretic stress–strain response output for
509 steel reinforcement.

510 **5.1.5 Cross-section rule**

511 A distributed-plasticity, force-based nonlinear beam-column element was selected for the analysis of
512 all columns. For FRP-steel confined RC columns, two beam-column elements were used to simulate
513 the FRP confined hinge zone of 500 mm height and the remaining part of the column, respectively,
514 which was described in Section 2.1. Similarly, two beam-column elements with the same element
515 size were used for RC columns or steel tube confined RC columns. A cantilever half-column model
516 was used in this simulation, which was used to be tested in this paper. As described in Section 2.1,
517 the steel tubes and the FRP wrapping were terminated at their two ends to avoid the direct axial
518 compression. Therefore, the steel tube and the FRP wrapping in the confined RC columns mainly
519 provide the confining effect for the concrete core. In order to simply the simulation, the models of the
520 stirrup, the steel tube and the FRP wrapping in the confined RC columns were not built in this paper,
521 while the confining effects of the three parts on the concrete core were considered by introducing the
522 above proposed stress-strain relationship of FRP-steel confined RC into the element, as demonstrated
523 by Fig. 16. The circular cross-section of all columns was divided into 36 parts in hoop direction and
524 30 parts in radial direction. Therefore, 1080 fibers were used in the paper. The 1080 fibers (36*30
525 fibers) were determined according to the balance between computational accuracy and computational
526 efficiency before ensuring convergence. However, a convergence study regarding the element size
527 and fiber number was not conducted in this paper.

528 **5.2 FEM model validation**

529 Fig. 17 presents a comparison between the simulated and tested results of RC column and FRP-steel
530 confined RC columns. It can be seen that the peak load of the simulated curves are very similar to
531 their measured values, and the corresponding lateral displacements were also consistent with the test
532 results. For the FRP-steel confined RC columns, the simulated curves were in good agreement with
533 their experimental curves. Although a new material constitutive model for FRP-steel confined
534 concrete, which would improve the pinching effect of the columns, was implemented in the analysis,
535 the pinching effect of the simulated curves is still more obvious than that of the test curves, especially
536 for the specimens G5S1T0, G7S1T0 and C7S1T0. This may be due to the fact that the slippage of
537 steel rebar and concrete is not considered, which was neglected to simplify the simulation in this
538 paper. Overall, the simulation results were in good agreement with the experimental results. Therefore,
539 it is feasible to use the OpenSees-based FEM model to simulate the seismic performance of FRP-steel
540 confined RC columns.

541 **5.3 Parametric study of FRP-steel confined RC columns**

542 To proper the seismic design of FRP-steel confined RC columns, it is necessary to understand the
543 influence of main parameters on the seismic performance of the columns to make reliable adjustments
544 accordingly based on laboratorial study. In this study, a parametric study was carried out on the effects
545 of various parameters on the seismic preformation of FRP-Steel confined RC columns. The basic
546 models from the above simulation program were used. The main structural parameters studied were
547 axial load ratio (0.1-0.8), shear span ratio (2-10), steel tube thickness (1-6 mm), longitudinal steel
548 ratio (change steel diameter), the number of FRP layers (1-8 layers), and the wrapping height of FRP
549 sheet in the columns (0-1000 mm).

550 **5.3.1 Effect of axial load ratio**

551 Based on the tested specimens G0S1T0 and G5S1T0, the axial load ratio ranges from 0.1 to 0.8, as
552 shown in Fig. 18, and the results demonstrate that during the increase of axial load, the bearing
553 capacity of the specimens under reversed cyclic loads also increases. However, the bearing capacity

554 of the specimens decreased with an increased axial load more rapidly in post-peak. This shows that
555 the ductility got lower as the axial load ratio increased. The specimen G5S1T0 confined by 5-layer
556 GFRP sheet showed a better ductility than that of the specimen G0S1T0 confined only by steel tube.

557 **5.3.2 Effect of shear span ratio**

558 Fig. 19 demonstrates the impact of shear span ratio on the seismic behaviour of the specimens
559 G0S1T0 and G5S1T0 without changing the other conditions. Results show that the effect of the shear
560 span ratio is basically the same when different types of external lateral confinement are used. As the
561 shear span ratios increased, the bearing capacity of the specimens decreased in turn. The peak
562 displacement also increased when shear span ratio increased meaning that the flexural capacity of the
563 columns was stronger.

564 **5.3.3 Effect of the thickness of steel tube**

565 Fig. 20 shows the results when the thickness of steel tube increased from 1 mm to 6 mm in the
566 specimens G0S1T0 and G5S1T0, respectively. It is observed that as the thickness of steel tube
567 increased, the ductility and load carrying capacities of the specimens were improved. Moreover,
568 changing the thickness of steel tube has a greater influence on the specimen G0S1T0, as its bearing
569 capacity and ductility have been improved more significantly, and its peak strain became higher. On
570 the other hand, due to the lateral confinement of five layers of GFRP sheet was considered over-
571 confining, the effect of the thickness of steel tube on the specimen G5S1T0 was not very significant.
572 It is observed that when using FRP-steel tube to confine RC columns in practice, it is not advisable
573 to increase the thickness of steel tube in order to get a stronger confinement. It should be considered
574 that the simply increasing of the tube thickness would increase the self-weight of the structures, which
575 is not ideal for resisting the seismic actions.

576 **5.3.4 Effect of longitudinal steel ratio**

577 The effect of longitudinal steel ratio on the seismic behaviour of FRP-steel confined RC columns was
578 examined by increasing the diameter of longitudinal reinforcement (D) of reference specimens. As

579 shown in Fig. 21, the results show that the bearing capacity of the two specimens is improved when
580 the reinforcement ratio of longitudinal reinforcement increases, but the influence on the degradation
581 ratio of the lateral load of the columns in post-peak is not obvious.

582 **5.3.5 Effect of the layer number and confining height of FRP sheet**

583 The effect of the number of FRP layers on the load-displacement skeleton curve of the columns is
584 shown in Fig. 22. It was obtained that the lateral ultimate load and its corresponding displacement of
585 the column increased as the number of GFRP layers increased. This indicates that as the number of
586 GFRP layers increases, the bearing capacity and ductility of the columns is increased. On the other
587 hand, based on the results of the specimen G5S1T0, the increase of the confining height of GFRP
588 sheet (0, 300, 500, 800, and 1000 mm, respectively) has no significant effect on the bearing capacity
589 and ductility of the specimens after the height reaches 300 mm. The height exceeds over 1.5 times of
590 the diameter of the columns which is similar to the case in RC elements reported before. Therefore,
591 the confining height of circular FRP-steel confined RC columns is suggested as 1.5 times of the
592 column's diameter, which can make the columns achieve an economical and reasonable lateral
593 confinement.

594 **6. Discussions**

595 **6.1 Plastic Hinge Region (PHR) height**

596 The predication of the lateral load–deformation behaviour of a concrete column involves an important
597 step, modelling the plastic hinge region (PHR) of the column (e.g. Inel and Ozmen 2006, Youssf et
598 al. 2015, Yuan et al. 2017). The region is defined as the deformation and damage region of elements,
599 which experience inelastic demands. Based on the literature, previous experimental studies on
600 concrete columns (unconfined or confined) assessed the PHR height by observing visually the
601 damage regions at both ends of the columns (e.g. Bae and Bayrak 2008, Liu and Sheikh 2013). The
602 damages mainly include cracks and spalling of concrete cover, which usually was considered that it
603 relates to the longitudinal plastic deformations of the columns. For FRP confined concrete elements,

604 Ozbakkaloglu and Sattcioglu (2006, 2007) recommended using the hoop-strain profiles of the tubes
605 to assess the PHR height, considering an intimate relationship between the lateral expansion of FRP
606 tube and inside damage sustained by concrete. This means that the concrete cover may damage with
607 a high probability when the corresponding hoop strain of FRP tube is high at the same position.
608 Ozbakkaloglu and Idris (2014) suggested the PHR height can be established through a hoop-
609 distribution of the specimens at its final loading cycle. They assumed that the PHR terminated at a
610 height where the hoop strain fell below $1/3^{\text{rd}}$ of the maximum-recorded strain in the cycle.

611 In this study, the PHR formation and propagation of the three types of tested columns, i.e. RC,
612 confined RC and confined SRC columns, were determined based on a combined method considering
613 the hoop strain evolution of the FRP-steel tube and the inside cracking formation of the specimens.
614 The average PHR height of RC column in the current paper was obtained from the measured height
615 of two sides of the column after the final load cycle. Regarding other confined RC/SRC columns, the
616 PHR height of steel tube confined RC/SRC columns (G0S1T0 and G0S1T1) was determined by
617 analysing the hoop-strain distribution of steel tubes along their height. For the FRP-steel confined
618 RC/SRC columns, the experimental observation, and strain analyses were conducted to assess their
619 PHR heights. The results presented in Figs. 5 and 7 show that the difference between the unconfined
620 and confined columns is high which can be mainly attributed to the different lateral confinement
621 conditions of the columns. The lateral confinement increases the ductility and deformability of the
622 columns meaning their PHR heights reduce. In addition, the strain evolutions of the steel tube
623 confined specimens and FRP-steel confined specimen such as G7S1T0 also show the difference of
624 the deformation capacity of the region is between 70 mm and 220 mm from the end of the columns.
625 The additional confinement from the FRP material increases the deformability of the confined
626 RC/SRC columns. The PHR height of the specimen G7S1T0 should be between 70 mm to 220 mm,
627 but it is more near to 70 mm. The damage shown in Fig. 5 verifies that the PHR height of the column
628 G7S1T0 is about 100 mm. Comparing with the specimens G7S1T0 and C7S1T0, the higher elastic
629 modulus and tensile strength of CFRP increases the hoop strain level at 220 mm from the end of the
630 columns. However, the hoop strains of the CFRP-steel tube at 70 mm and 220 mm both are quite

631 small, which means its PHR height was not changed significantly being equal to that of GFRP-steel
632 confined RC columns. It can also be explained by the fact that CFRP and GFRP both are very strong
633 in tension compared with the steel tube. Within the SRC columns, there was no obvious difference
634 between the PHR height of steel tube confined SRC columns and FRP-steel confined SRC columns,
635 which both were about between 70 mm to 100 mm. As described previously, the H-section steel
636 already makes the RC columns be strong for the resistance of seismic action. This indicates that the
637 additional lateral confinement of FRP materials does not affect the deformability and ductility of the
638 columns.

639 **6.2 Peak drift level of confined RC columns**

640 As described previously, comparing with conventional RC columns, all confined RC columns of this
641 study presented an excellent seismic behaviour. However, the lateral load of the columns also started
642 to cause a degradation with an increase of the lateral displacement after reaching their peak load.
643 There were many researchers who had explained the reasons of the degradation (e.g. Ang 1985, Cai
644 et al. 2015) and indicated the degradation of RC columns with increasing lateral displacement was
645 very important considering safety aspects of the structures subjected to strong earthquake. To promote
646 the performance- or drift-based design of RC structures subjected to strong earthquake attacks, Cai et
647 al. (2015) proposed a complete shear design model for circular concrete columns, which was able to
648 predict the degradation of the lateral shear resistance of the columns under a mega-earthquake. As
649 shown in their model, Cai et al. (2015) pointed out that the effective lateral confinement factor (I_c) of
650 circular RC columns had a significant influence on the peak drift ratio of the columns, which was
651 denominated as the degradation-starting drift ratio R_{iu} . The drift ratio is calculated by a ratio of Δ_{max}/L
652 (where, Δ_{max} is the displacement corresponding to peak load point and L is the shear span of the
653 columns). For discussing the drift ratio of the confined RC columns, this study collected several RC
654 columns confined by steel tube or FRP-steel tube by existing literature (Liu et al. 2009, Zhou and Liu
655 2010, Gan et al. 2011, Lin 2012). Using the FEM analysis results in this paper, a data set of the
656 confined RC columns with shear span ratio (a/D) larger than 1.5 and axial load ratio (n) exceeding of

657 0.3 was modelled and analysed. In theory, these columns have a stronger trend to fail as flexural
 658 failure mode. Referring to the model developed by Cai et al. (2015), the effective lateral confinement
 659 factor (I_c) of FRP-steel confined RC columns is calculated by

$$660 \quad I_c = \frac{\rho_{hs} \cdot f_{hs}}{f_{co}} + \frac{\rho_{hst} \cdot f_{hst}}{f_{co}} + \frac{\rho_{hfrp} \cdot f_{hfrp}}{f_{co}} \quad (10)$$

661 where ρ_{hs} is the volume ratio of stirrup; ρ_{hst} and ρ_{hfrp} is the equivalent stirrup volume ratio of the
 662 steel tube and the FRP tube, respectively; f_{hs} and f_{hst} are the yield strength of the stirrup and the
 663 steel tube, respectively; f_{hfrp} is the hoop stress of the FRP tube at peak point taken as about 10% of
 664 ultimate strength of FRP according to the test results;

665

666 Fig.23 shows the relationship between peak drift ratio R_{iu} and the effective lateral confinement factor
 667 I_c of the columns confined by the steel or FRP-steel tube, by steel tube and by FRP-steel tube. Results
 668 show that the factor I_c has a different influence on the peak drift level of circular confined RC columns
 669 comparing with the case in circular RC columns. According to existing design codes, most of circular
 670 RC columns have an I_c factor less than 0.3 and have a peak drift varying from 0.5% to 2.5%. The
 671 increasing of I_c brings a larger increase in the peak drift ratio in Cai et al. model (Cai et al. 2015).
 672 This can be explained by the fact that the increase of lateral confinement of RC columns has a more
 673 significant effect on the enhancement of peak drift ratio of shear-dominant columns. In the data
 674 established in the paper, however, all confined columns are flexural-dominant columns. Besides, the
 675 I_c factors of the RC columns confined by steel or FRP-steel tube had a larger varying region. The
 676 peak drifts ratios of the columns increased with the I_c factors. Comparing with the case of steel tube
 677 or FRP-steel tube confined RC columns, a stronger linear relationship was found between the I_c factor
 678 and the peak drift ratio R_{iu} of steel tube confined RC columns. However, as shown in Fig.23, the
 679 existing data of FRP-steel tube confined columns is not enough for determining the relationship
 680 between I_c and R_{iu} in these columns. Therefore, the paper suggests that peak drift ratio R_{iu} of the RC
 681 columns confined by steel tube or FRP-steel tube can be calculated simply at the beginning by

$$682 \quad R_{iu} = 2.6I_c + 0.8 \quad (\text{in } \%) \quad (11)$$

683 **7. Concluding Remarks**

684 This paper investigated the behaviour of FRP-steel confined concrete columns under reversed cyclic
685 lateral loads through a series of experiments, including RC (reference column), steel tube confined
686 RC/SRC columns, and FRP-steel confined RC/SRC columns. Flexural failures were observed for all
687 columns. The following conclusions can be made:

- 688 • With the increase of the number of FRP layers, the structural behaviours (including yield load
689 and displacement, peak load and displacement, ultimate load and displacement, and ductility
690 coefficient) of the FRP-steel confined RC/SRC columns have been improved.
- 691 • The load-carrying capacity, ductility and energy dissipation capacity of FRP-steel confined
692 RC columns were better than those of RC columns and steel tubes confined RC columns.
693 Moreover, the improvement caused by the lateral confinement increased as the number of
694 layers of FRP increased. Similar observations occurred in FRP-steel confined SRC columns
695 when comparing with SRC column or steel tube confined SRC column.
- 696 • FRP wrapping has no significant effect on the initial stiffness of FRP-steel confined RC/SRC
697 columns. However, with the increase of the lateral displacement and with more layers of FRP
698 sheet confining, the stiffness degradation of the columns was reduced.

699 Based on the proposed FEM model verified by the test results in the paper, a parametric analysis has
700 been conducted to analyse main factors on the behaviour of GFRP-steel confined RC columns. The
701 main observations are as follows:

- 702 • With the increase of the axial load ratio and the shear span ratio, the load-bearing capacity of
703 steel tube confined and FRP-steel confined RC columns has been improved, while the ductility
704 of the columns has been significantly reduced.
- 705 • The load-bearing capacity of steel tube and FRP-steel confined RC columns increased as the
706 thickness of steel tube increased, while the former kind of the columns increased more
707 significantly. However, the thickness has no significant influence on the ductility of the columns.
- 708 • The increase of the longitudinal reinforcement ratio improved the load-bearing capacity of steel

709 tube and FRP-steel confined RC columns but just has little effect on the ductility of the columns.

710 • The increase of the number of FRP layers enhanced the ultimate load-bearing capacity and
711 ductility of FRP-steel confined RC columns, but the positive effect was weakened after a
712 certain number of FRP layers were applied. It is need more studies to quantify this for the
713 FRP-steel confined RC columns. The change in the height of FRP wrapping has no significant
714 influence on the load-bearing capacity and ductility the columns after the height reaches 1.5
715 times of the column's diameter.

716 On the other hand, this study discussed the influence of main variables on the plastic hinge region
717 (PHR) height and peak drift ratio of the confined RC columns under reversed cyclic loads and
718 presented that the lateral confinement condition has a significant influence on the PHR height and
719 peak drift ratio of the confined RC columns. Based on the existing test data, the paper suggests a
720 simple model to predict the peak drift ratio of the confined RC columns as well.

721 **Acknowledgements**

722 This work was supported by the National Key R&D Program of China (Project No.
723 2017YFC0703008), the National Natural Science Foundation of China (Project No.51778102,
724 51708433), the Fundamental Research Funds for the Central Universities (Project No.
725 DUT18LK35)and the Natural Science Foundation of Liaoning Province of China (Project No.
726 20180550763).

727 **References**

728 Aboutaha, R. S., and Machado, R. I. (1999). "Seismic resistance of steel-tubed high-strength
729 reinforced-concrete columns." *J. Struct. Eng.*, 125(5), 485-494.

730 Ang, B.G. (1985). "Seismic shear strength of circular bridge piers." *Rep. No. 85-5*, Department of
731 Civil Engineering, University of Canterbury, Christchurch, New Zealand.

732 Bae, S., and Bayrak, O. (2008). "Plastic hinge length of reinforced concrete columns." *ACI Struct.*
733 *J.*, 105(3), 290.

734 Binici, B. (2005). "An analytical model for stress-strain behavior of confined concrete." *Eng.*
735 *Struct.*, 27(7), 1040-1051.

736 Cai, G., Sun, Y., Takeuchi, T., and Zhang, J. (2015). "Proposal of a complete seismic shear strength
737 model for circular concrete columns." *Eng. Struct.*, 100, 399-409.

738 Cao, Q., Tao, J., Wu, Z., and Ma, Z. J. (2017). "Behavior of FRP-Steel Confined Concrete Tubular
739 Columns Made of Expansive Self-Consolidating Concrete under Axial Compression." *J. Compos.*
740 *Constr.*, 21(5), 04017037.

741 Gan, D., Guo, L., Liu, J., and Zhou, X. (2011). "Seismic behavior and moment strength of tubed
742 steel reinforced-concrete (SRC) beam-columns." *J. Constr. Steel Res.*, 67(10), 1516-1524.

743 GB 50010-2010. (2015). "Code for design of concrete structures." Ministry of House and Urban-
744 Rural Development of People's Republic of China, Beijing (in Chinese)

745 GB/T228-2010. (2009). "Tensile test method for the metal materials at room temperature."
746 Standardization Administration of the People's Republic of China, Beijing 2010. (in Chinese)

747 Han, L. H., Liu, W., and Yang, Y. F. (2008). "Behavior of thin walled steel tube confined concrete
748 stub columns subjected to axial local compression." *Thin Wall Struct.*, 46(2), 155-164.

749 Han, L. H., Qu, H., Tao, Z., and Wang, Z. F. (2009). "Experimental behaviour of thin-walled steel
750 tube confined concrete column to RC beam joints under cyclic loading." *Thin Wall Struct.*, 47(8-9),
751 847-857.

752 Han, L. H., Yao, G. H., Chen, Z. B., and Yu, Q. (2005). "Experimental behaviours of steel tube
753 confined concrete (STCC) columns." *Steel Compos. Struct.*, 5(6), 459-484.

754 Hu, H. and Seracino, R. (2013). "Analytical model for FRP-and-steel-confined circular concrete
755 columns in compression." *J. Compos. Constr.*, 18(3), A4013012.

756 Hu, Y. M., Yu, T. and Teng, J. G. (2011). "FRP-Confined Circular Concrete-Filled Thin Steel
757 Tubes under Axial Compression." *J. Compos. Constr.*, 15(5), 850-860.

758 Huang, P.D. (2016). "Cyclic Axial Compression Mechanical Behavior Study of GFRP-Steel
759 Composite Tube Confined RC Stub Columns." MS Thesis of Dalian University of Technology,

760 Dalian. [In Chinese]

761 Inel, M., and Ozmen, H. B. (2006). "Effects of plastic hinge properties in nonlinear analysis of
762 reinforced concrete buildings." *Eng. Struct.*, 28(11), 1494-1502.

763 JGJ3-2002. (2002). "Technical Specification for Concrete Structures of Tall Buildings."
764 Standardization Administration of the People's Republic of China, Beijing; 2002. (in Chinese)

765 Jiang, T., and Teng, J. G. (2007). "Analysis-oriented models for FRP-confined concrete." *Eng.*
766 *Struct.*, 29, 2968-2986.

767 Kent, D.C. and Park, R. (1971) "Flexural members with confined concrete." *J. Struct. Division*,
768 97(7), 1969-1990.

769 Lam, L., and Teng, J.G. (2009). "Stress-strain model for FRP-confined concrete under cyclic axial
770 compression". *Eng. Struct.*, 31(2), 308-321.

771 Li, Y. F., Chen, S. H., Chang, K. C., and Liu, K. Y. (2005). "A constitutive model of concrete
772 confined by steel reinforcements and steel jackets." *Can. J. Civil Eng.*, 32(1), 279-288.

773 Lin, S. L. (2012). "Seismic performance of FRP-steel composite tube confined RC columns." MS
774 Thesis of Harbin Institute of Technology, Harbin. (In Chinese)

775 Liu, J. P., Xu, T. X., Wang, Y. H., and Guo, Y. (2018). "Axial behaviour of circular steel tubed concrete
776 stub columns confined by CFRP materials." *Constr. Build Mater.*, 168, 221-231.

777 Liu, J., and Sheikh, S. A. (2013). "Fiber-reinforced polymer-confined circular columns under
778 simulated seismic loads." *ACI Struct. J.*, 110(6), 941.

779 Liu, J., Zhang, S., Zhang, X., and Guo, L. (2009). "Behavior and strength of circular tube confined
780 reinforced-concrete (CTRC) columns." *J. Constr. Steel Res.*, 65(7), 1447-1458.

781 Liu, L., and Lu, Y. (2010). "Axial bearing capacity of short FRP confined concrete-filled steel
782 tubular columns." *J. Wuhan Univ. Tech.-Mater. Sci. Ed.*, 25(3), 454-458.

783 Mazzoni, S., McKenna, F., Scott, M.H., and Fenves, G.L. (2006). *OpenSees command language*
784 *manual*. Pacific Earthquake Engineering Research (PEER) Center.

785 Menegotto, M., and E. Pinto. (1973). "Method of analysis for cyclically loaded reinforced concrete
786 plane frames including changes in geometry and non-elastic behavior of elements under combined
787 normal force and bending." Proc., IABSE Symposium. Lisbon, Portugal, 15-22.

788 Orakcal, K., Massone, L.M.,Wallence, J.W. (2006). "Analytical modeling of reinforced concrete
789 walls for predicting flexural and coupled-shear-flexural responses." PEER, University of California.
790 USA.

791 Ozbakkaloglu, T., and Idris, Y. (2014). "Seismic behavior of FRP-high-strength concrete-steel
792 double-skin tubular columns." J. Struct. Eng., 140(6), 04014019.

793 Ozbakkaloglu, T., and Saatcioglu, M. (2006). "Seismic behavior of high-strength concrete columns
794 confined by fiber-reinforced polymer tubes." J. Compos. Constr., 10(6), 538-549.

795 Ozbakkaloglu, T., and Saatcioglu, M. (2007). "Seismic performance of square high-strength
796 concrete columns in FRP stay-in-place formwork." J. Struct. Eng., 133(1), 44-56.

797 Park, J. W. and Choi, S. M. (2013). "Structural behavior of CFRP strengthened concrete-filled
798 steel tubes columns under axial compression loads". Steel Compos. Struct., 14(5), 453-472.

799 Park, J. W., Hong, Y. K. and Choi, S. M. (2010). "Behaviors of concrete filled square steel tubes
800 confined by carbon fiber sheets (CFS) under compression and cyclic loads." Steel Compos.
801 Struct., 10(2), 187-205.

802 Park, R. (1988). "State of the art report ductility evaluation from laboratory and analytical testing."
803 Proc., 9th World Conf. Earthq. Eng., Tokyo, Kyoto, Japan, 605-616.

804 Popovics, S. (1973). "A numerical approach to the complete stress-strain curve of
805 concrete." Cement Concrete Res., 3(5), 583-599.

806 Ran J.H. (2014). "Axial Compression Mechanical Behavior of FRP-Steel Composite Tube
807 Confined Concrete Stub Columns." MS Thesis of Dalian University of Technology, Dalian. [In
808 Chinese]

809 Sakino, K., Nakahara, H., Morino, S., and Nishiyama, I. (2004). Behavior of centrally loaded
810 concrete-filled steel-tube short columns. *J. Struct. Eng.*, 130(2), 180-188

811 Scott, B. D., Park, R., and Priestley, M. J. N. (1982). "Stress-strain behavior of concrete confined
812 by overlapping hoops at low and high strain rates." *ACI Struct. J.*, 79(1), 13-27.

813 Tao, Z., Wang, Z., Han, L. and Uy, B. (2011). "Fire performance of concrete-filled steel tubular
814 columns strengthened by CFRP." *Steel Compos. Struct.*, 11(4), 307-324.

815 Teng, J. G., Hu, Y. M. and Yu, T. (2013). "Stress-strain model for concrete in FRP-confined steel
816 tubular columns." *Eng. Struct.*, 49(2),156-167.

817 Tomii, M., Sakino, K., Watanabe, K. and Xiao, Y. (1985a). "Lateral load capacity of reinforced
818 concrete short columns confined by steel tube", *Proc., Int'l Speciality Conf. Concr. Filled Steel*
819 *Tubular Struct.*, Harbin, China, August, pp. 19-26.

820 Tomii, M., Sakino, K., Xiao, Y. and Watanabe, K. (1985b). "Earthquake resisting hysteretic
821 behavior of reinforced concrete short columns confined by steel tube", *Proc., Int'l Speciality Conf.*
822 *Concr. Filled Steel Tubular Struct.*, Harbin, China, August, pp. 119-125.

823 Wang, D.Y. (2012). "Experimental and analytical investigation of seismic performance of nonductile
824 RC frames retrofitted with FRP." *Ph.D Dissertation of Harbin Institute of Technology*, Harbin. (in
825 Chinese)

826 Wang, Z., Yu, Q. and Tao, Z. (2015). "Behaviour of CFRP externally-reinforced circular CFT
827 members under combined tension and bending." *J. Constr. Steel Res.*, 106, 122-137.

828 Wu, Z., Wang, X., Zhao, X., and Noori, M. (2014). "State-of-the-art review of FRP composites for
829 major construction with high performance and longevity." *J. Sustainable Mater. Struct. Sys.*, 1(3),
830 201-231.

831 Xiao, Y. (2004). "Applications of FRP composites in concrete columns." *Adv. Struct. Eng.*, 7(4),
832 335-343.

833 Xiao, Y., He, W., and Choi, K. K. (2005). "Confined concrete-filled tubular columns." *J. Struct.*
834 *Eng.*, 131(3), 488-497.

835 Youssf, O., ElGawady, M. A., and Mills, J. E. (2015). "Displacement and plastic hinge length of
836 FRP-confined circular reinforced concrete columns." *Eng. Struct.*, 101, 465-476.

837 Yu, Q., Tao, Z., Liu, W., and Chen, Z. B. (2010). "Analysis and calculations of steel tube confined
838 concrete (STCC) stub columns." *J. Constr. Steel Res.*, 66(1), 53-64.

839 Yu, T., Hu, Y. M. and Teng J. G. (2016). "Cyclic lateral response of FRP-confined circular
840 concrete-filled steel tubular columns." *J. Constr. Steel Res.*, 124, 12-22.

841 Yuan, F., Wu, Y. F., and Li, C. Q. (2017). "Modelling plastic hinge of FRP-confined RC
842 columns." *Eng. Struct.*, 131, 651-668.

843 Zhou, X. H., Liu, J. P., Wang, X., and Chen, Y. F. (2016). "Behavior and design of slender circular
844 tubed-reinforced-concrete columns subjected to eccentric compression." *Eng. Struct.*, 124, 17-28.

845 Zhou, X. H., Yan, B., and Liu, J. P. (2015). "Behavior of square tubed steel reinforced-concrete
846 (SRC) columns under eccentric compression." *Thin Wall Struct.*, 91, 129-138.

847 Zhou, X., Cheng, G., Liu, J., Gan, D., and Chen, Y. F. (2017). "Behavior of circular tubed-RC
848 column to RC beam connections under axial compression." *J. Constr. Steel Res.*, 130, 96-108.

849 Zhou, X.H., and Liu, J. P. (2010). "Seismic behavior and shear strength of tubed RC short
850 columns." *J. Constr. Steel Res.*, 66(3), 385-397.

1 **Tables**

2 Table 1 Details of test specimens

3 Table 2 Material properties of steel, FRP and epoxy adhesive

4 Table 3 Summary of the test results of test specimens

5

6

7

Table 1 Details of test specimens

Test No.	Diameter D /mm	Thickness t_s /mm	Reinforcing bars	Stirrups	The number of layers of FRP sheet	FRP type	Setting of H-Steel
G0S0T0	300	-			-	-	No
G0S1T0	300	3			-	-	No
G5S1T0	300	3			5	GFRP	No
G7S1T0	300	3	6 Φ 16	Φ 8@100	7	GFRP	No
C7S1T0	300	3			7	CFRP	No
G0S1T1	300	3			-	-	Yes
G5S1T1	300	3			5	GFRP	Yes
G7S1T1	300	3			7	GFRP	Yes

Noted: G/Cx: x-layers GFRP or CFRP sheet; S0/S1: without/with confined steel tube; T0/T1: without/with H-steel;

8

9

Table 2 Material properties of steel, FRP and epoxy adhesive

Materials	Diameter or thickness (mm)	Young's modulus E_s /GPa	Yielding strength f_y /MPa	Tensile strength f_u /MPa
Steel tube Q235	3	210	280	414
Stirrups Q345	8	206	400	540
Reinforcing rebar Q345	16	205	420	590
H-Steel wing/web plates	10/7	208/221	223/225	374/387
Materials	Thickness t_{fp} /mm	Young's modulus E /GPa	Elongation δ /%	Tensile strength f /MPa
CFRP	0.167	245	1.51	4077
GFRP	0.354	72	2.1	1500
Epoxy	-	≥ 2.4	≥ 1.50	≥ 38

10

11

12

Table 3 Summary of the test results of test specimens

Specimens	P_y	Δ_y /mm	P_{max} /kN	Δ_{max} /mm	P_u /kN	Δ_u /mm	R/%	μ_Δ
G0S0T0	80.55	8.30	92.95	13.42	79.01	16.44	1.37	1.98
G0S1T0	96.44	10.49	110.95	21.68	94.30	43.90	3.66	4.19
G5S1T0	101.84	12.37	122.29	24.91	103.95	52.11	4.34	4.21
G7S1T0	107.01	14.53	128.72	27.83	109.41	62.70	5.23	4.32
C7S1T0	103.81	11.52	122.97	24.60	104.53	51.37	4.28	4.46
G0S1T1	149.83	13.99	158.45	35.79	134.68	72.64	6.05	5.19
G5S1T1	150.34	14.78	172.46	36.22	155.22	77.81	6.48	5.26
G7S1T1	165.07	15.47	186.78	39.75	168.10	81.99	6.83	5.30

Noted: μ_Δ is displacement ductility coefficient, which is calculated by Δ_u/Δ_y .

13

Fig.1

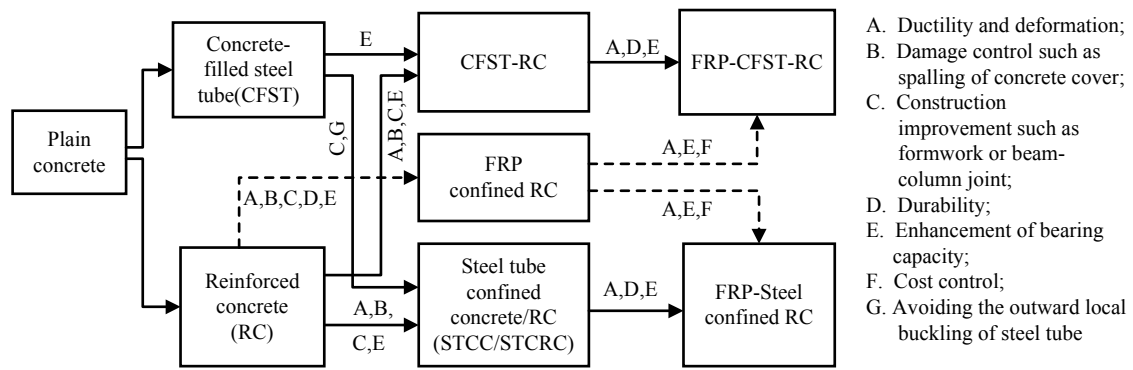

Fig.1 Development of reinforced concrete and confined concrete in past decades

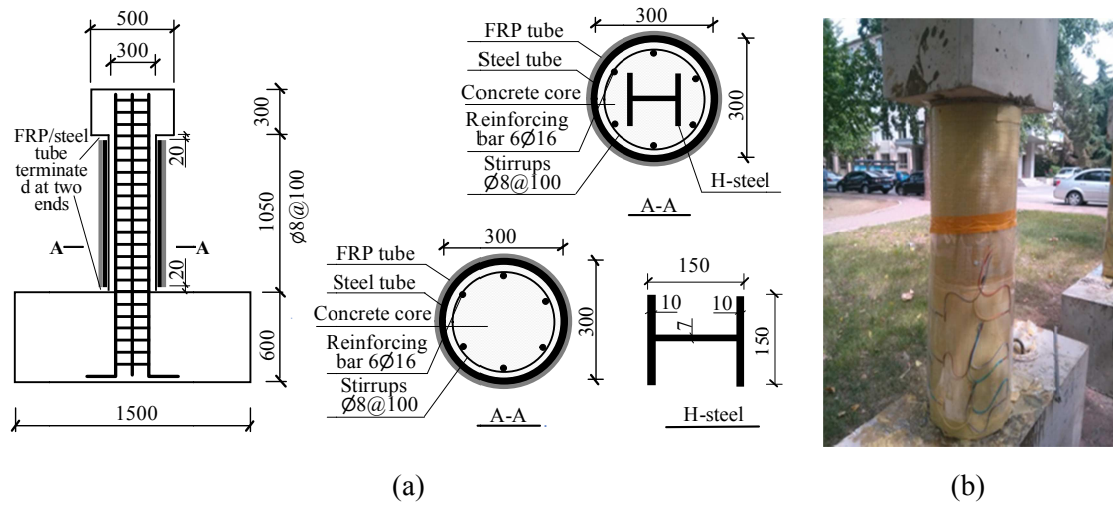

Fig. 2 Details of test specimens (Units in mm): (a) Dimension and reinforcement arrangement; (b) Confined columns

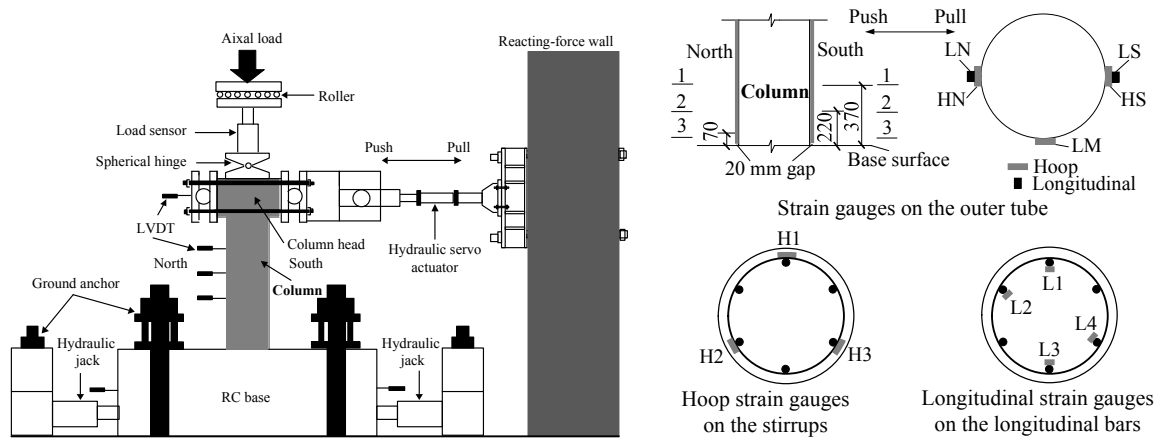

Fig. 3 Test setup and layout of LVDTs and strain gauge (Units in mm)

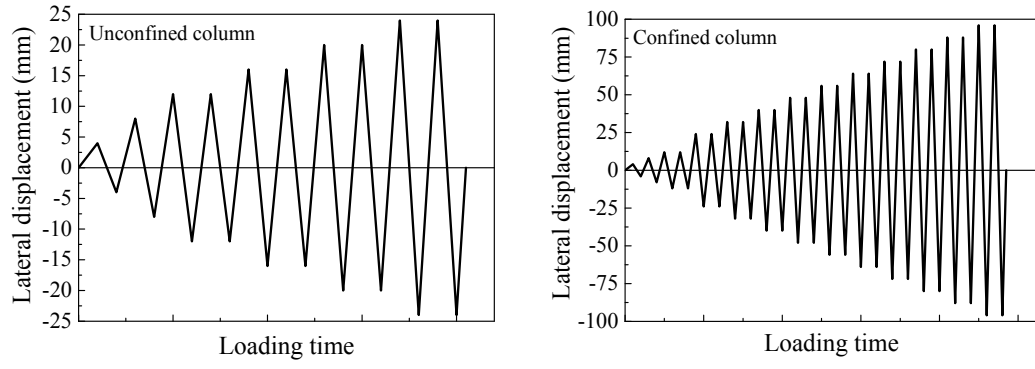

Fig. 4 Loading procedure

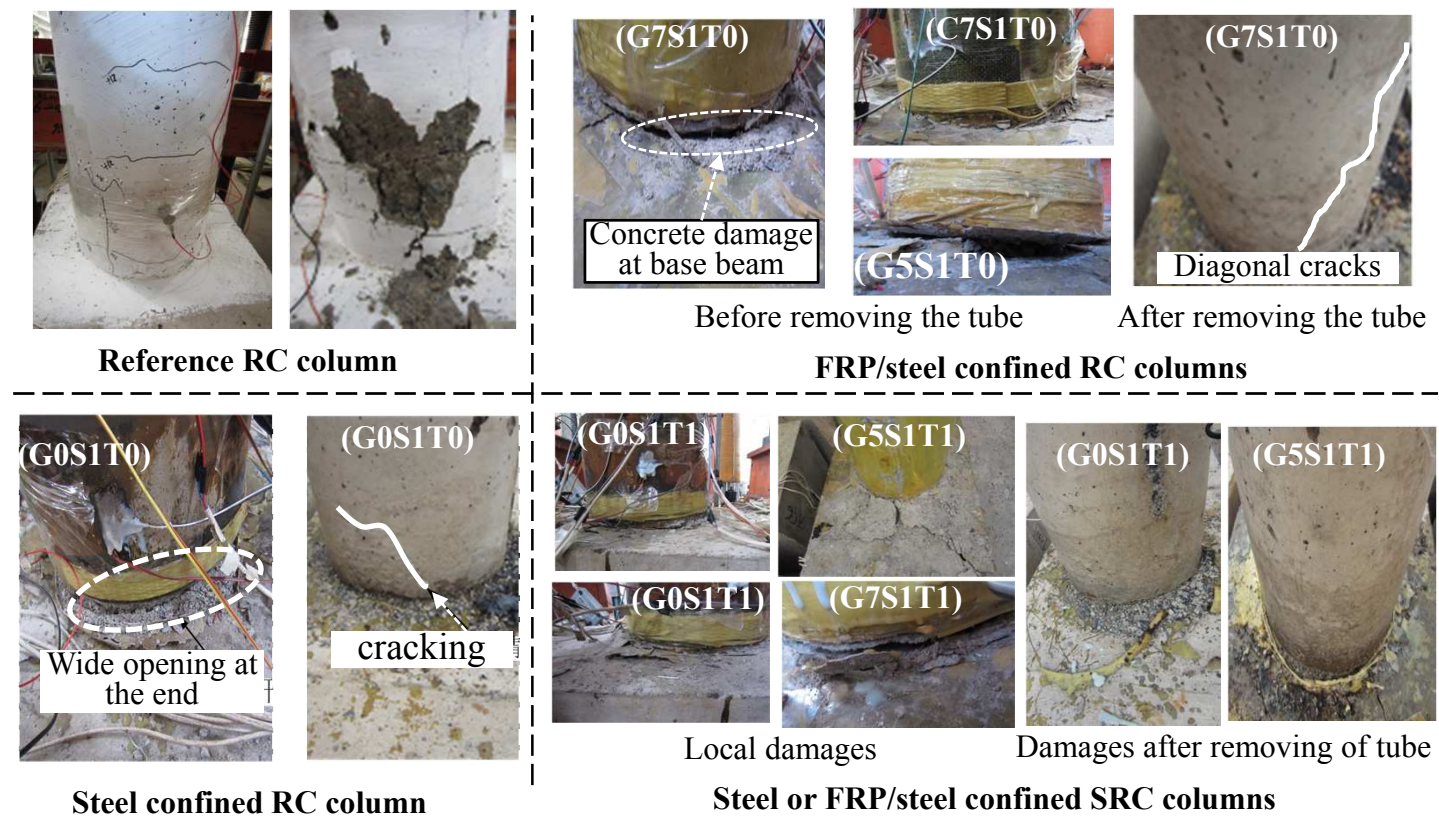

Fig. 5 Damages and cracks of the specimens

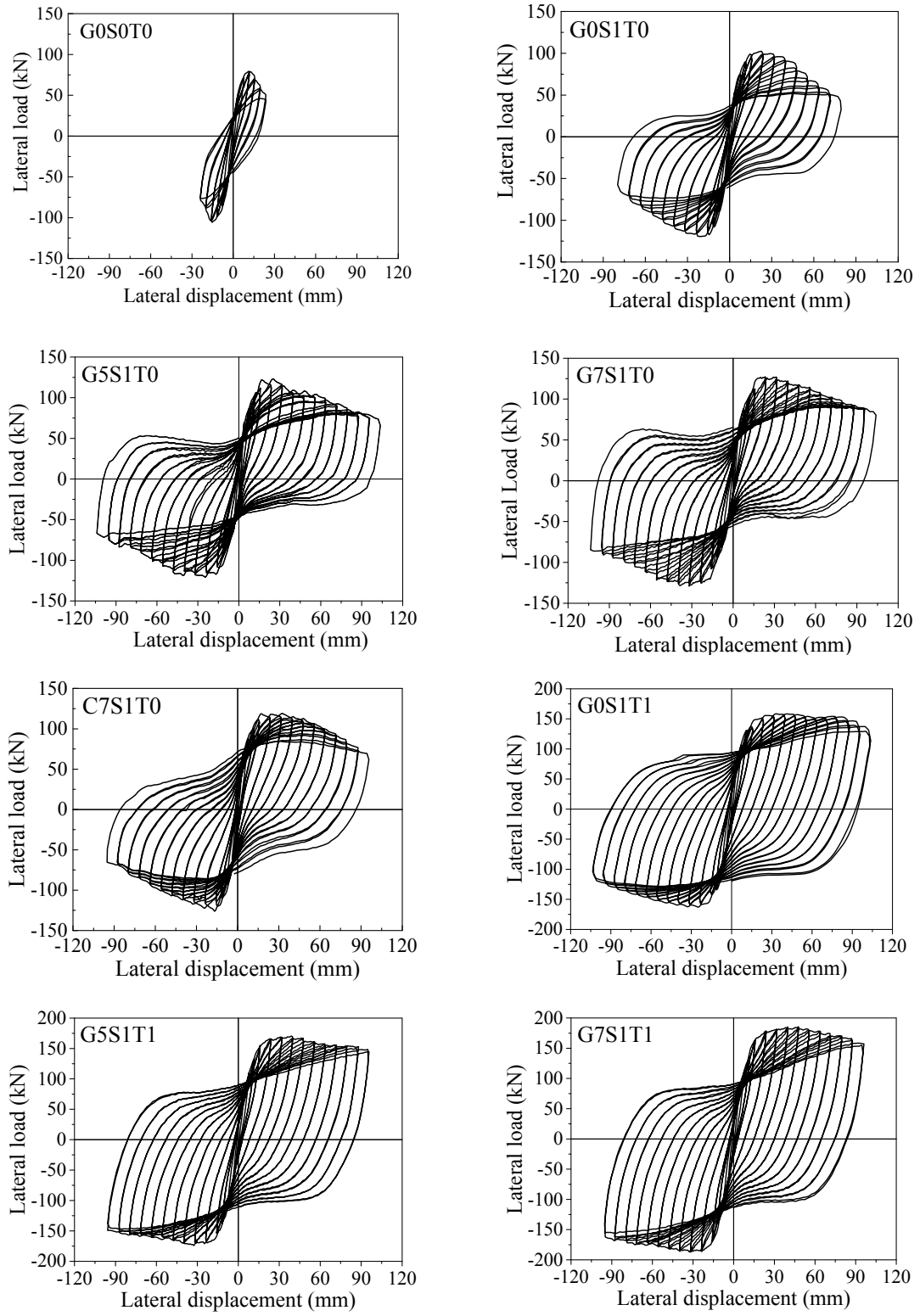

Fig.6 Hysteresis behavior of the specimens

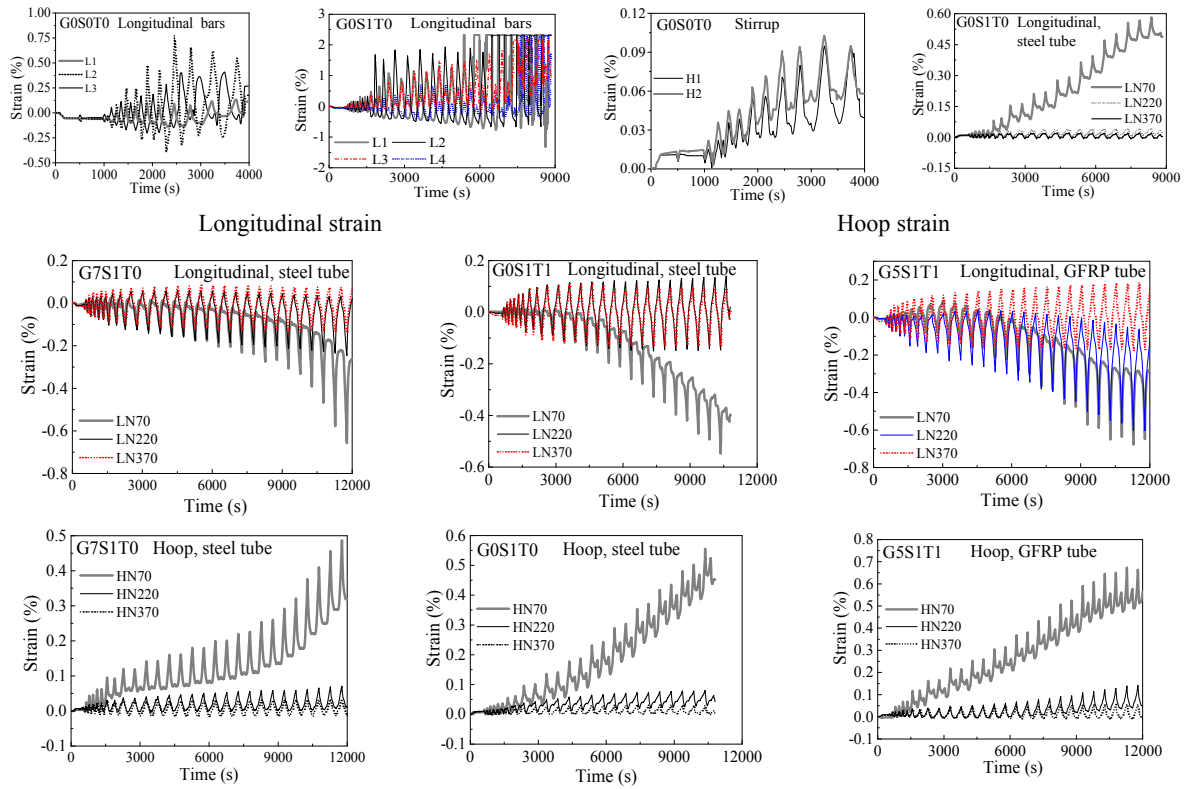

Fig. 7 Strain evolution of reinforcing bars, steel tube and FRP tube

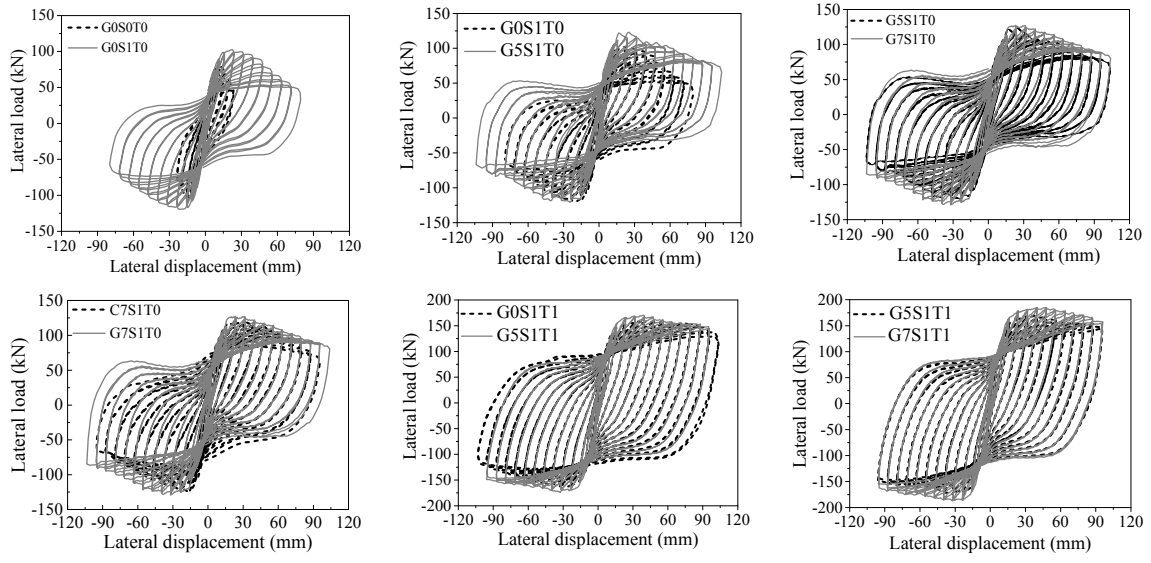

Fig. 8 Comparison of experimental lateral load-displacement curves

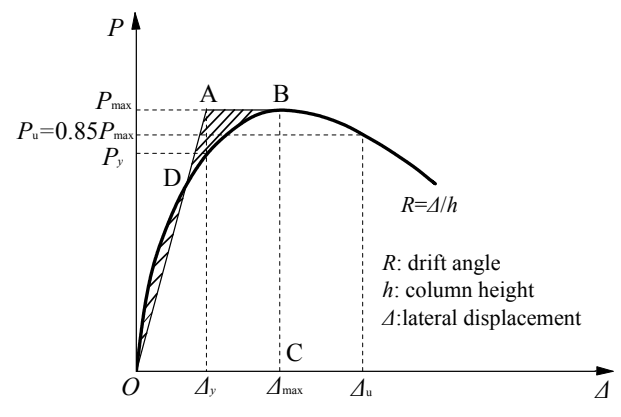

Fig. 9 Ductility calculation method – the equivalent elastoplastic energy absorption method (Park 1988)

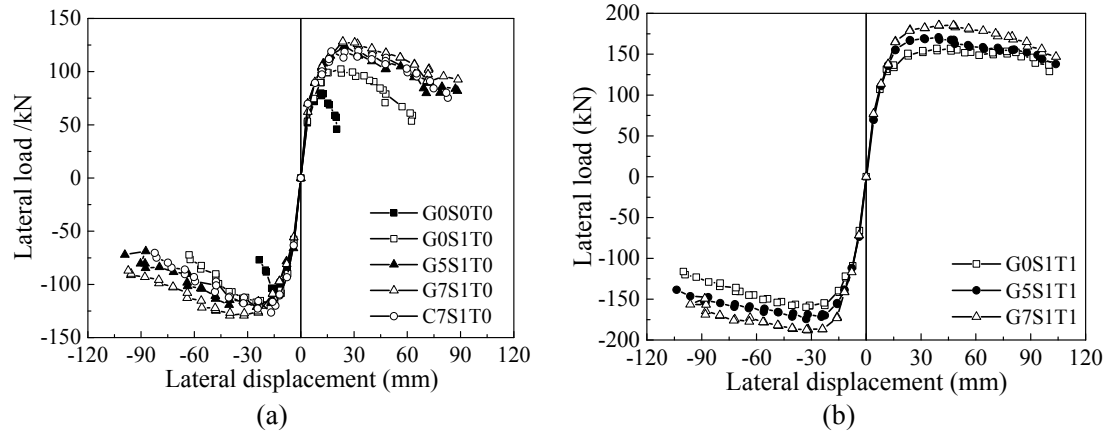

Fig. 10 Experimental load-displacement skeleton curves: (a) Without H-steel; (b) With H-steel

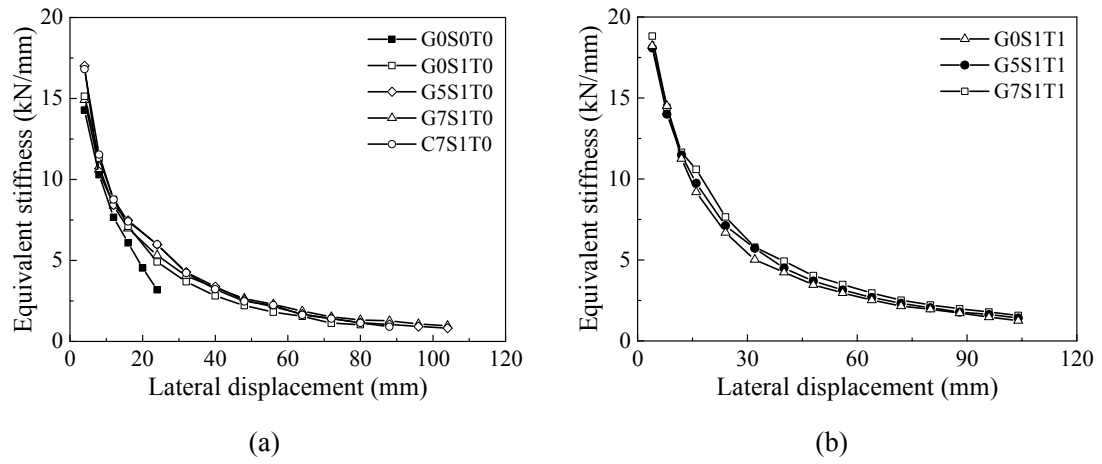

Fig. 11 Evolution of the equivalent stiffness of test specimens: (a) Without H-steel; (b) With H-steel

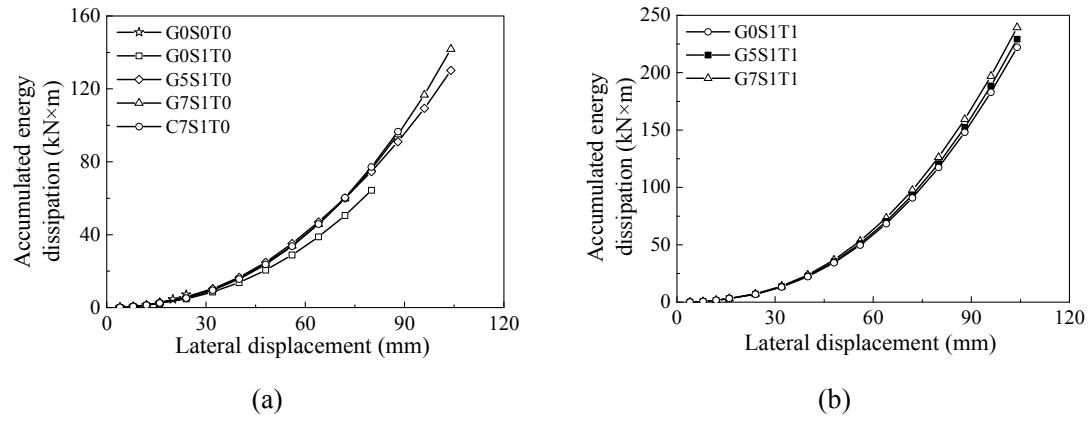

Fig. 12 Accumulated energy dissipation of the test specimens: (a) Without H-steel; (b) With H-steel

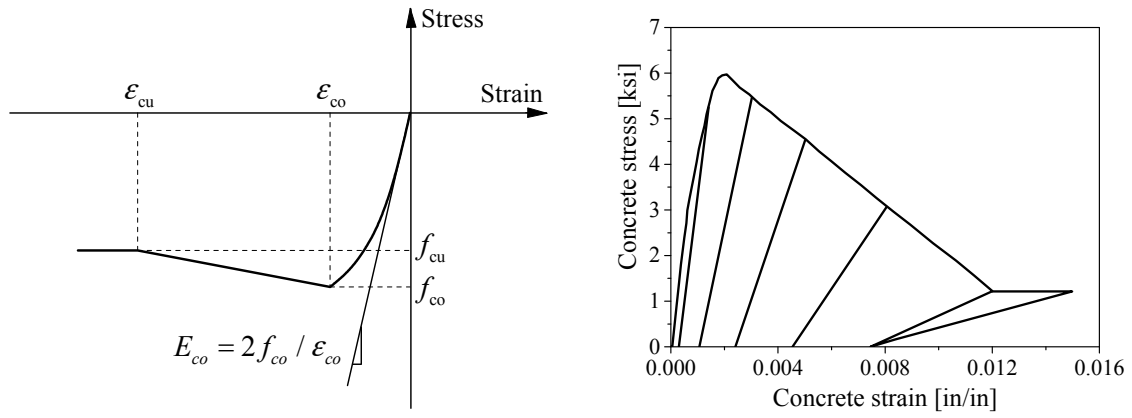

Fig. 13 Stress-strain models of Concrete01 in OpenSees (Mazzoni et al. 2006)

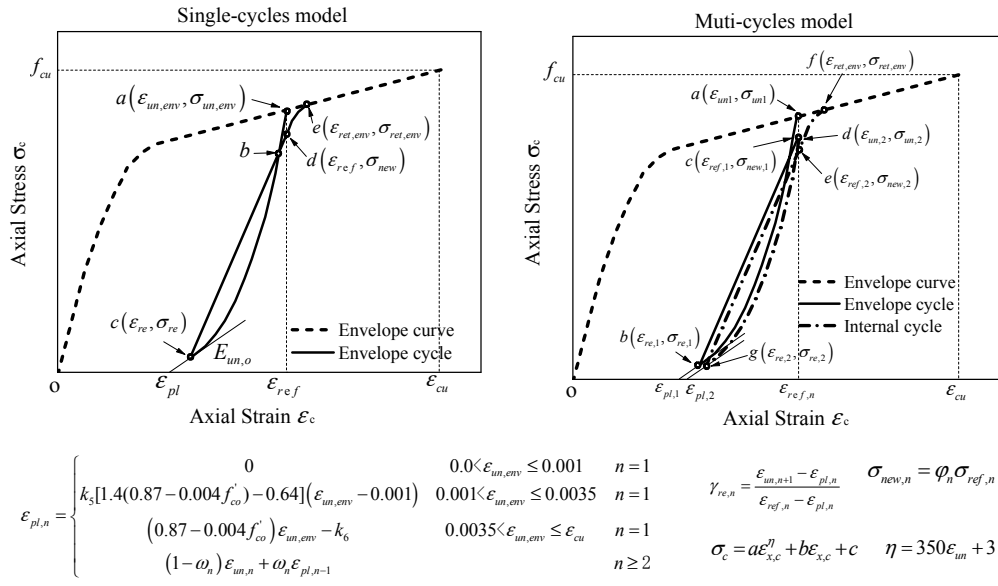

Fig. 14 Key parameters of proposed cyclic constitutive models (Huang 2016)

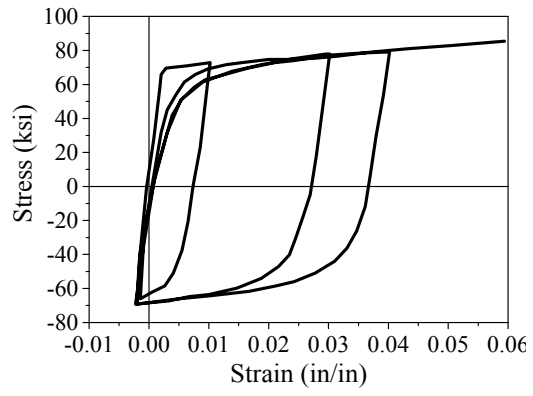

Fig. 15 Hysteretic property of Steel02 model in OpenSees

Fig.16

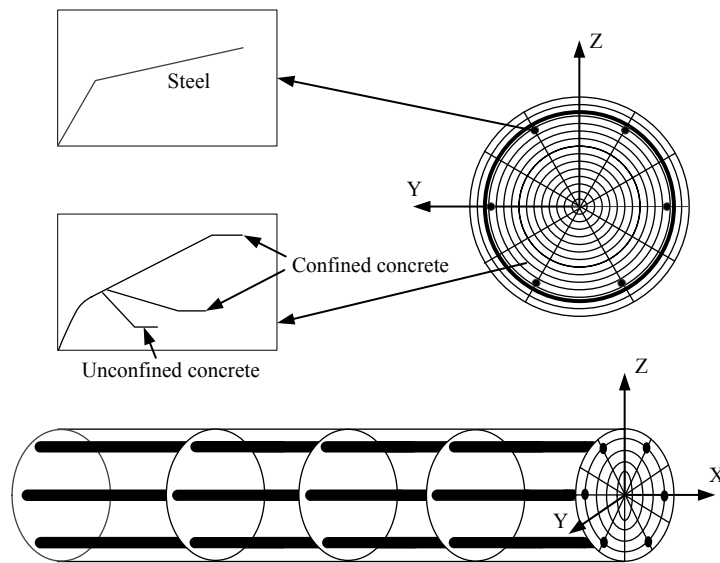

Fig. 16 Schematic representation of the fibre's cross-section

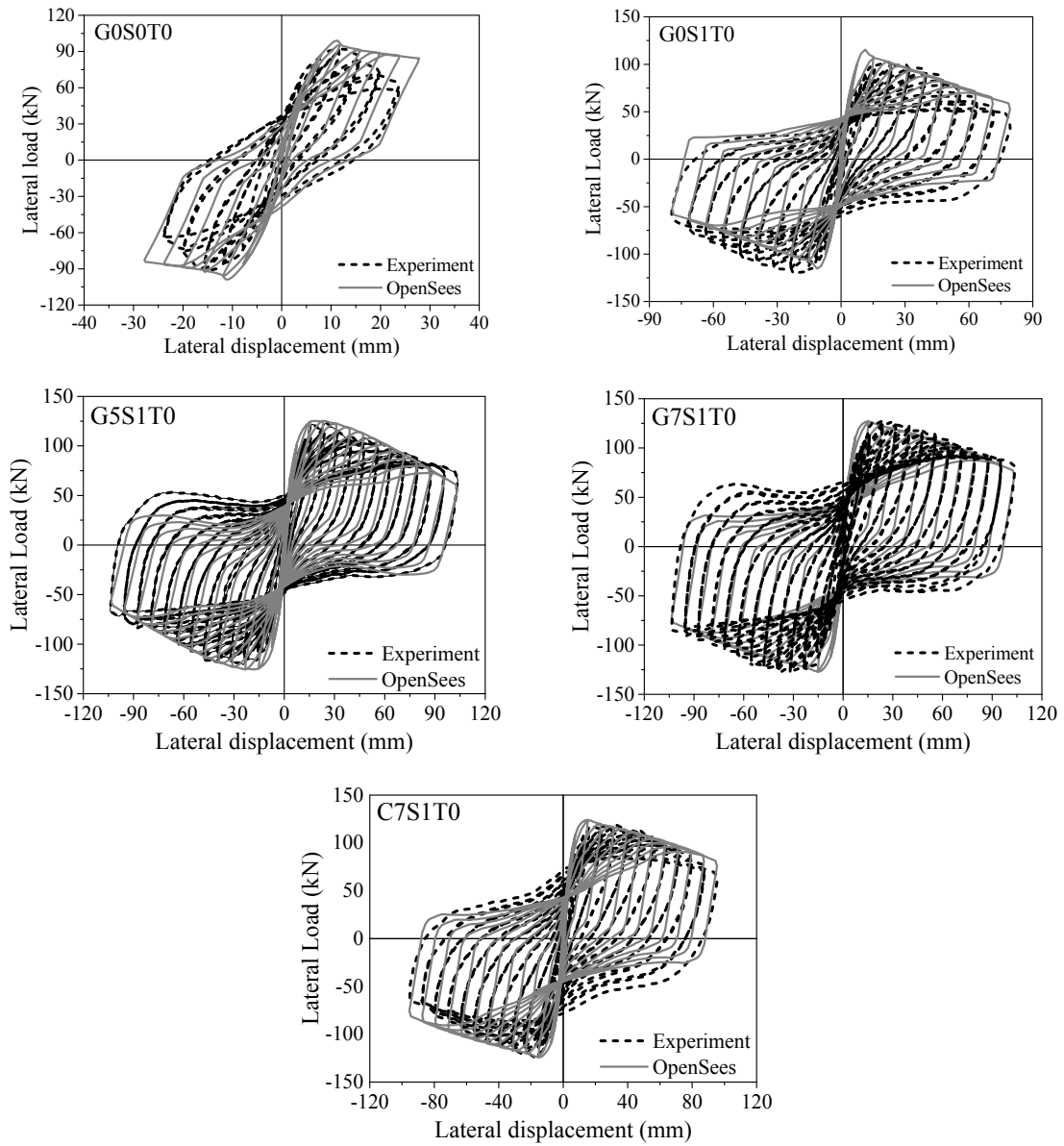

Fig. 17 Comparison between simulation and test results of circular RC and confined RC columns

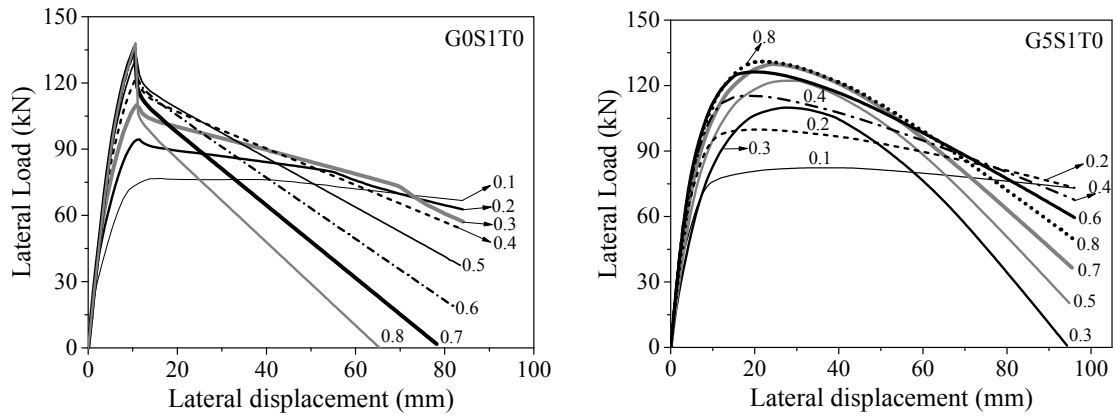

Fig. 18 Influence of axial load ratio on FRP-steel confined RC columns

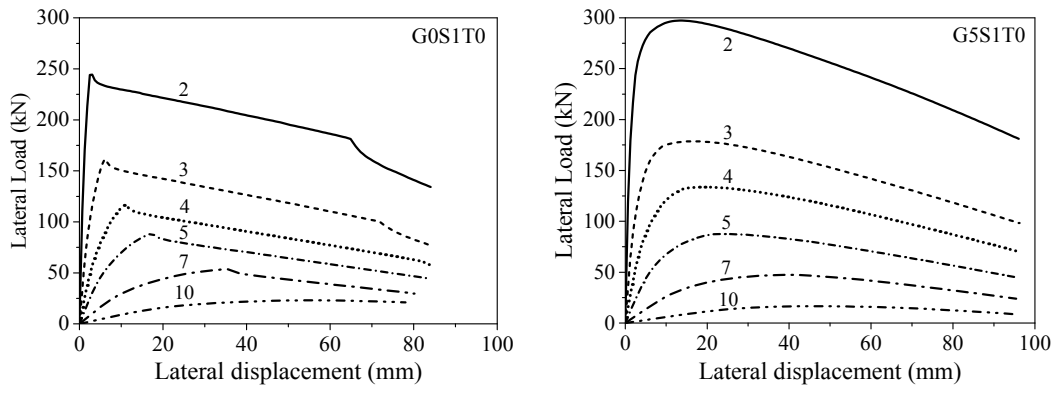

Fig. 19 Influence of shear-span ratio on FRP-steel confined RC columns

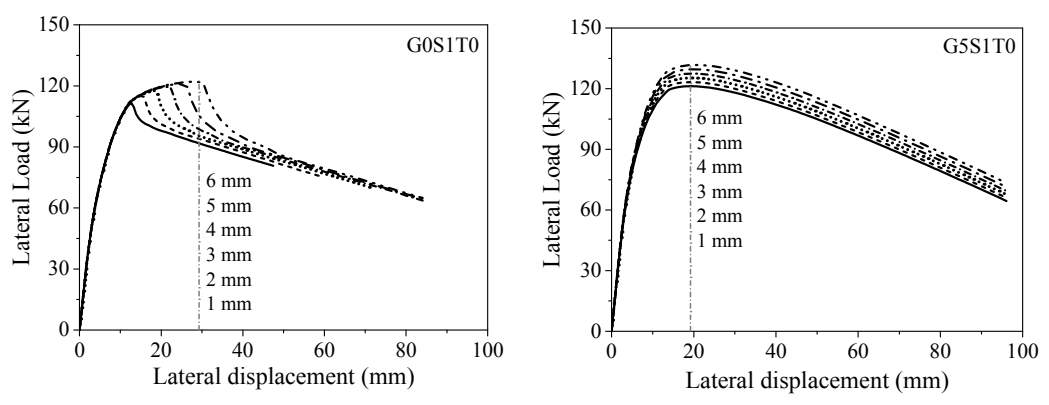

Fig. 20 Effects of steel tube thickness on FRP-steel confined RC columns

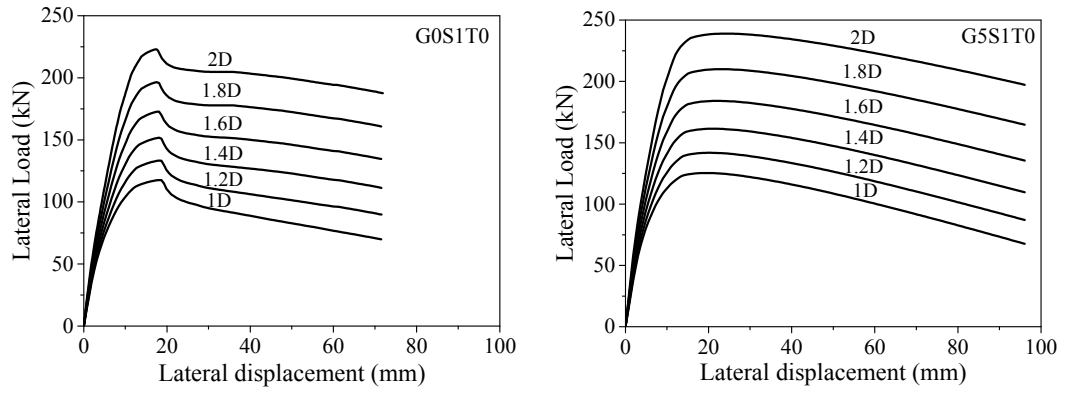

Fig. 21 Effects of longitudinal bars ratio on FRP-steel confined RC columns

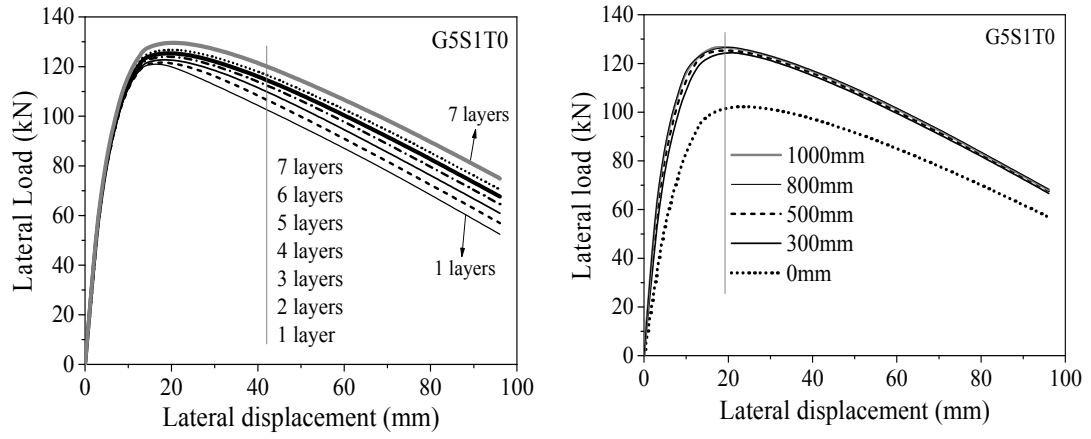

Fig. 22 Effects of confining layer number and the height of GFRP on the confined columns

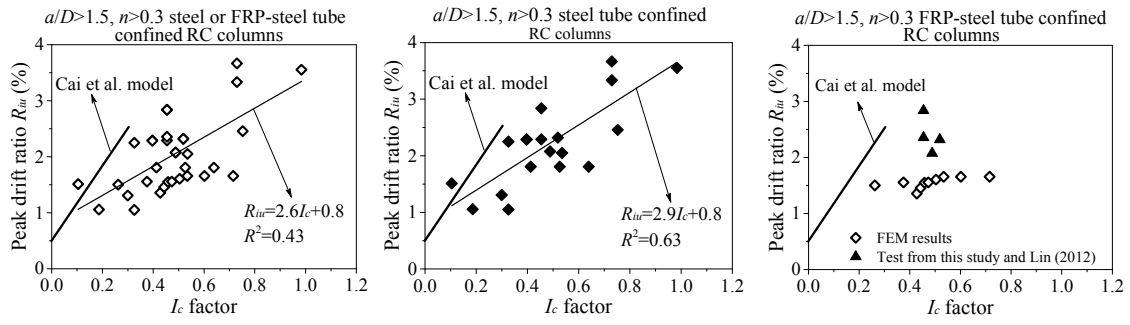

Fig.23 Relationship between peak drift ratio and I_c factor of confined RC columns