



HAL
open science

First Validation of Robust REBCO Insert Concept on a Large 20-Pancake Prototype Reaching Up to 25 T

Arnaud Badel, K Takahashi, A Zampa, T Okada, G Nishijima, T Uto, H Takewa, S Hanai, S Ioka, J Inagaki, et al.

► To cite this version:

Arnaud Badel, K Takahashi, A Zampa, T Okada, G Nishijima, et al.. First Validation of Robust REBCO Insert Concept on a Large 20-Pancake Prototype Reaching Up to 25 T. IEEE Transactions on Applied Superconductivity, 2023, 33 (5), pp.4601505. 10.1109/TASC.2023.3255178 . hal-04084081

HAL Id: hal-04084081

<https://hal.science/hal-04084081>

Submitted on 28 Nov 2023

HAL is a multi-disciplinary open access archive for the deposit and dissemination of scientific research documents, whether they are published or not. The documents may come from teaching and research institutions in France or abroad, or from public or private research centers.

L'archive ouverte pluridisciplinaire **HAL**, est destinée au dépôt et à la diffusion de documents scientifiques de niveau recherche, publiés ou non, émanant des établissements d'enseignement et de recherche français ou étrangers, des laboratoires publics ou privés.

First validation of Robust REBCO insert concept on a large 20-pancake prototype reaching up to 25 T

A. Badel, K. Takahashi, A. Zampa, T. Okada, G. Nishijima, T. Uto, H. Takewa, S. Hanai, S. Ioka, and J. Inagaki, S. Awaji,

Abstract— We recently proposed a robust REBCO HTS (RareEarth BaCuO) insert coil concept in the framework of a project to upgrade the 25 T Cryogen-Free Superconducting Magnet at the High Field Laboratory For Superconducting Materials to reach 30 T. In this concept, the conductor consists of a two-tape bundle to mitigate the risks posed by local tape degradation. So-called edge impregnation is used to enhance the mechanical stiffness while reducing delamination risk, providing conduction-cooling capability at the same time. This insert is to be protected against the risk of thermal runaway simply by using dump resistor, thanks to an early detection concept. The different ideas forming the robust REBCO insert coil concept were tested successfully on various small scale prototypes. We report here their first implementation on a large-size insert coil, consisting of 20 stacked pancakes from the 30 T CSM upgrade insert. The mechanical behavior of the coil is modelled and validated with experiments. The thermal runaway detection setup is introduced. Its sensitivity and selectivity is discussed based on previous works on thermal runaway scenarios.

Index Terms— High field Superconducting magnet, Insulated REBCO magnet, numerical modelling, Quench protection .

I. INTRODUCTION

The 25 T Cryogen-Free Superconducting Magnet was installed in 2017 as a user magnet at the High Field Lab. For Superconducting Materials, of the Institute for Material Research, Tohoku University [1]. It consists in an 11 T BiSrCaCuO HTS insert with a 14 T LTS outsert. It was the first user magnet operating above 23 T, and is still to date the only conduction-cooled magnet operating above that limit, even though several other user or commercial magnets operate now above 25 T or are expected to do so [2-4]. Since then research activities were conducted at HFLSM together with Toshiba to develop the technology for REBCO insert for upgrading this magnet to reach 30 T while retaining the ease of use offered by cryogen-free operation of an insulated magnet [5, 6]. Numerous small scale pancake prototypes were tested, leading to the final design for this upgrade presented in [7], in which a concept of robust REBCO insert coil and its protection against thermal runaway were introduced, with a few key features:

This work was supported by JSPS KAKENHI under Grant 18H05248. (Corresponding author: Arnaud Badel.)

A. Badel is with the High Field Laboratory for Superconducting Materials, Institute for Materials Research, Tohoku University, Sendai 980-8577, Japan and also with University of Grenoble Alpes, G2Elab/Néel Institute, CNRS, Grenoble 38042, France. (e-mail: arnaud.badel@neel.cnrs.fr).

To ensure the conduction-cooling efficiency and improve the winding structure, the pancakes are epoxy-impregnated, using a non-stick material in between turns. This pancake winding structure is expected to homogenize significantly the hoop stress distribution.

To limit the transient losses and to achieve fast dynamics, the turns are fully insulated. In this way, the insert can be discharged in a few seconds, as fast as the outsert, limiting energy transfer from one to the other during an outsert quench [8].

To reduce the risk that a local defect could prevent operation at nominal current, the conductor is formed of two REBCO co-wound so that current can be shared [9]. Both tapes have their superconducting layers facing inward, in a “face-to-back” configuration as in [6, 9].

Recently, the effort was shifted from upgrading the existing 25 T CSM to the development of a new magnet, reaching 33 T. The outsert specifications for this new magnet are presented in [10]. It will also generate 14 T but in a slightly larger bore to accommodate a larger insert generating 19 T. The REBCO insert specifications are not finalized but it will be based on the ideas introduced for the robust REBCO insert concept as mentioned above. In this work, a first large scale validation of these ideas is presented, for a prototype made of 20 pancakes. The present paper focuses on the mechanical modelling of this prototype, and its thermal runaway detection setup.

II. WINDING CHARACTERISTICS AND TEST ENVIRONMENT

The coil is made of 20 stacked pancakes. Each of these pancake are first dry-wound, then epoxy glue is applied on the pancake surfaces to bond the thin FRP flanges (0.2 mm approx.). This technique, combined with the turn-to-turn separation by

K. Takahashi, T. Okada, A. Zampa, and S. Awaji are with the High Field Laboratory for Superconducting Materials, Institute for Materials Research, Tohoku University, Sendai 980-8577, Japan

G. Nishijima is with National Institute for Materials Science, Tsukuba 305-0003, Japan.

T. Uto, T. Takewa, S. Hanai, S. Ioka, and J. Inagaki are with Toshiba Energy System and Solutions Corporation, Yokohama 230-0045, Japan.

fluorine-coated Polyimide achieve the so-called edge-impregnation, where the turns are glued to the thin FRP flanges but not to each other, preventing delamination. The pancakes are first glued two by two with one thin aluminum cooling sheet in between and connected electrically at their inner diameter by a silver plate to form Double Pancakes. Then these DPs are stacked, and connected electrically at the outer diameter also with silver plates.

Fujikura tapes [11] with thick (80 μm overall) Cu coating are used. As explained in introduction, the conductor is a bundle of two tapes in face-to-back configuration. In previous studies [9] this ensured sufficient current redistribution between the tapes in case of local degradation of the critical current even though the distance between layers is higher than in face-to-face configuration. The turn to turn electrical insulation is a co-wound Polyimide tape (50 μm thick in this case) with Fluorine coating, which as mentioned before serves also as non-stick layer to prevent delamination. The winding characteristics are presented in Table I.

All the pancakes were tested individually at LN2 temperature before assembly for quality control. After assembly the coil was equipped with strain gauges at the outer diameter for circumferential and axial strain measurements. More details on the pancake preliminary tests, the coil and its strain instrumentation can be found in [12].

The tests were conducted at the National Institute for Material Science in Tsukuba, in a 14 T Superconducting large bore outsert. These tests were primarily aimed at mechanical performance validation, which is the reason why they were made with LHe cooling. More tests in conduction cooling are planned in the next months. The current source available onsite and suitable for powering few H-range inductances is rated at 300 A. This current is 1.22 times the nominal current expected for these pancakes in the 30 T upgrade [7]. As it will be explained in the next part, under 14 T these 300 A makes it possible to reach 350 MPa, the peak stress that was expected for the 30 T upgrade. This validates the mechanical design of the whole insert, even though there are 20 pancakes instead of the full stack of 52. The combined field value is slightly in excess of 25 T, 11 T being produced by the 20 REBCO pancakes.

III. MECHANICAL MODELLING AND VALIDATION OF MECHANICAL PERFORMANCES

As discussed in the previous section, the REBCO pancakes use edge impregnation. In such case the hoop stress cannot be successfully predicted using the BJR equation, which is valid only if the turns do not interact with each other and with the rest of the structure. Nor can it be predicted using the classical Wilson formula, which is valid only for a winding pack behaving as an isotropic bulk piece. Indeed with edge impregnation, the turns are not glued together, only to the flanges. In consequence, the radial stiffness of the winding is only due to flanges, which are much thinner than the conductor width (by an order of magnitude). This can be seen as a solid winding pack but with strongly anisotropic properties, whose behavior could be

TABLE I
WINDING CHARACTERISTICS

REBCO Tape (Fujikura)	EuBa ₂ Cu ₃ O _y / BaHfO ₃
No. of bundled tapes	2 (face-to-back)
Tape width	4 mm
Inner diameter (mm)	68.0
Outer diameter (mm)	266
Turn per pancake	279
No. of pancakes	20
Max source current (A)	300
Self-inductance (H)	2.63
Conductor current density (A/mm ²)	244
Peak hoop stress @ 300 A (under 14 T back)	346 MPa
Total tape length	5.8 km
Center Field (under 14 T back)	25.25 T

described following [13]. The estimation of the equivalent elastic properties of the winding structure is however complex.

Here we prefer to use an FEM model to represent the complex winding structure, including the turns, the mandrel and the glued flanges and cooling plates. To keep the FEM solving simple, the contacts are all considered as thin elastic interfaces: A layer with very low Young's Modulus (1 MPa) represent the turn to turn interface, which is not glued due to the non-stick material, while the epoxy glue between the conductor and the FRP flanges is represented realistically as a thin layer with a Young Modulus of 10 GPa (Fig. 1). Tensile stress tests were conducted on the REBCO tapes used in this coil. The equivalent

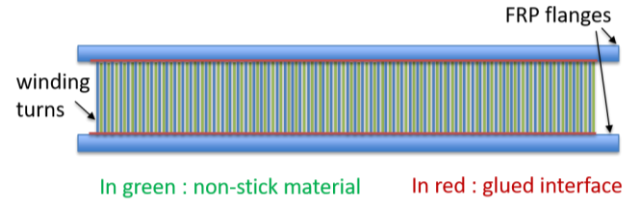

Fig. 1. Winding model schematics.

Young Modulus of the tapes at cryogenic temperatures was estimated in-house at 130 GPa.

The hypothesis of weak elastic boundary between turns is only valid if the turns tend to separate from each other under load, which is the case here. If there is significant radial pressure, as in the case of pancakes with external reinforcement and/or under smaller background fields, the model must be modified. In general and to keep the model simple, an iterative approach can be conducted. The simulation is stopped when the radial stress become negative (pressure between turns), the soft elastic boundaries are removed in the area under pressure, then the simulation is run again. The process is repeated until no soft interface is under pressure anywhere. The same modelling approach was already used successfully to match experimental results in [5, 6] and [14]. The tensile strength of the Polyimide layer being negligible compared to that of the REBCO tapes, it is ignored in the model. That is, each turn is considered as one element in the model, with a thickness including the Polyimide

co-winding. Then a ratio of 350/300, corresponding to “total turn thickness” over “thickness of 2 REBCO tapes”, is applied to the hoop stress and strain results.

Fig. 2 presents the mechanical modelling results under 14 T for 300 A, highest current that can be reached with the experimental setup. As mentioned in part II, these operation condition makes it possible to reach almost 350 MPa in the winding, approximately at the middle of the winding at the center of the stack.

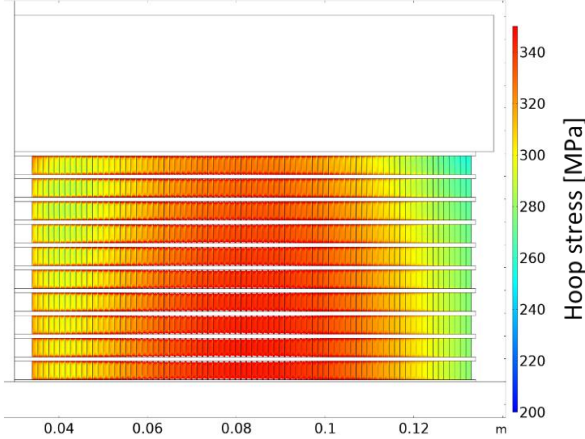

Fig. 2. Estimated Hoop stress at 300 A under 14 T in the upper half of the 20 pancake stack. Hoop stress exists in the flanges and mandrel but is too low to appear on scale.

The stress distribution comparison between the BJR hypothesis (in blue) and the FEM model (in red) highlight the benefit of the edge impregnation, as it homogenizes the hoop stress and reduces the peak value from 407 to 346 MPa (Fig. 3). Experimental measurement were only obtained at the outer diameter, where the estimated stress is 280 MPa. This should correspond 0.215 % elongation considering the Young Modulus of the conductor. The strain measurement detailed in [12] reach 0.23 % for circumferential elongation at outer turn, which is in good agreement. Fig. 4 presents an estimation of the radial stress in the FRP flanges. This stress could not be measured but appears realistic, in line with what was measured in [14].

The successful tests of this 20-pancake-stack coil validated the mechanical design of the 30 T upgrade as presented in [7]

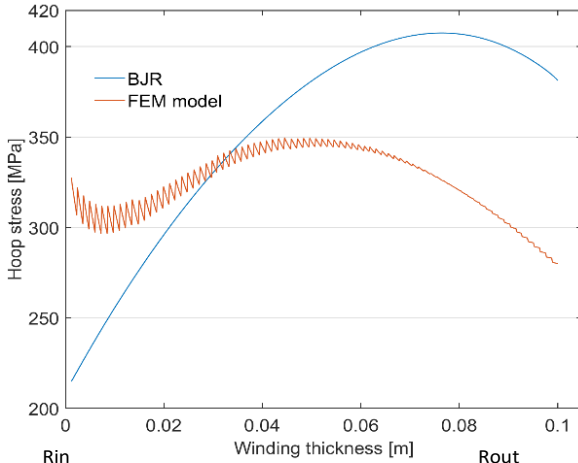

Fig. 3. Estimated Hoop Stress across the middle pancakes at 300 A under 14 T.

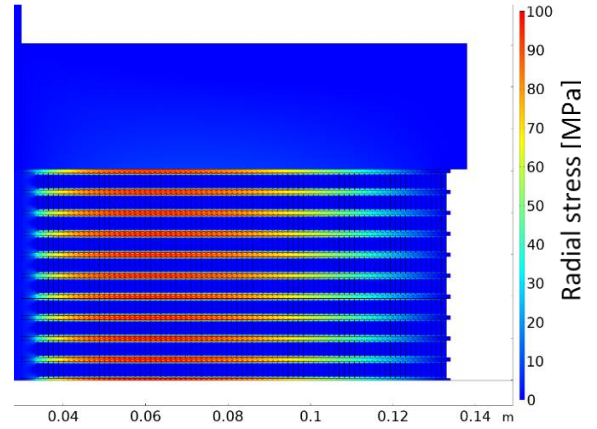

Fig. 4. Estimated radial stress at 300 A under 14 T in the upper half of the 20 pancake stack.

and in general the benefits of edge impregnation, an important aspect for robust REBCO insert concepts. It is also beneficial when considering the potential stress concentration effect due to inhomogeneous distribution of current density in REBCO tapes (shielding currents). This aspect will be covered in future works.

IV. ROBUST INSULATED REBCO COIL PROTECTION: THERMAL RUNAWAY ONSET DETECTION SETUP

A. Robust REBCO coil protection concept

An important aspect of the robust REBCO insert coil concept we proposed is the protection against the risk of thermal runaway. As discussed first in [15], the large thermal stability of HTS coils, even operating at low temperature, makes it unlikely that a quench occur after a limited burst of energy deposition. The protection system has therefore two major and rather independent roles. On one hand protecting against major instability events, such as a loss of cooling power or more importantly a quench of the outsert magnet. On the other hand, protecting against the consequences of local dissipation due to tape performances inhomogeneities or local conductor defects, leading to a local overstepping of the critical current. The former is actually the easiest for an insulated coil, as it can be discharged fast. It was studied in [8] and will not be covered here. The latter is more challenging for insulated REBCO coils as a destructive thermal runaway can occur in one or a few seconds depending on the current density in the conductor, as the current cannot bypass from one turn to the other like in Non-Insulated windings [16, 17]. The probability of a local critical current drop and its consequences are strongly mitigated by the use of a 2 tape bundle conductor [9]. In [8] it was estimated through detailed thermos-electric modelling that even though the thermal runaway itself occurs too fast for protecting the coil using a dump resistor, the dissipation levels are measurable (in the 1 – 10 mV range in the current density range we are using here) a few seconds before, time enough to initiate a preemptive discharge preventing the thermal runaway to occur. The challenge is then to

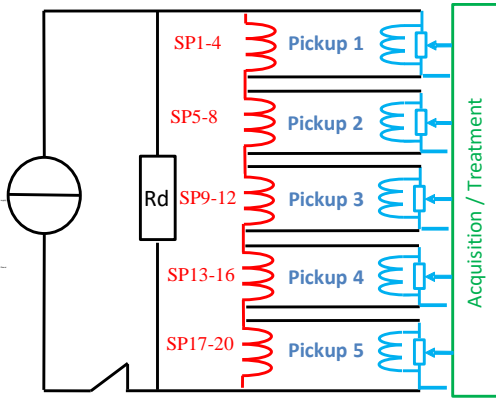

Fig. 5. Dissipative Signal Detection Bridge with 5 channels.

discriminate this dissipative signal from the other transient signals across the coil as discussed first in [18] and more in details in [19]. Moreover, it is important to be able to localize an eventual dissipative area so that the faulty pancake can be replaced without damage to the other pancakes. It should be noted that this local dissipation detection is in principle necessary only during qualification of the coil, and not for its later nominal operation.

B. Detection system implementation and tests for 20 pancake coil

Following [20] a multi-channel detection bridge is used, with independent pickup coils for inductive voltage cancelation. Here for practicality the 20 pancakes are grouped 4 by 4 leading to 5 detection channels (Fig. 5). The 5 compensation coils are wound on top of each other with 0.2 mm diameter copper wire and impregnated with epoxy to prevent wire movements. The assembly is mounted at the bottom of the REBCO insert. This position is not ideal for coupling, which means that the inductances of these pickup coils had to be increased significantly. A localization in the clear bore of the magnet would be more suitable but that one was occupied by coil support structure in this particular test.

Fig. 6 and 7, the time evolution of each 5 compensated signals is presented during a ramp up to 300 A, in self-field and under 14 T background field respectively. During the self-field tests, the ramp rate was set at 0.4 A/s. It was lowered to 0.2 A/s for the test under background field in order to get lower voltage drift due to transient effects. Multiple plateau were also made to check for pancake-to-pancake contact degradations due to stress increase. No increase of resistance due to such degradations were observed (see [12] for more details)

In both cases, the initial values of the compensated signals at the onset of a ramp are meaningless, they only result from the compensation bridge adjustment. As described in [19] the voltage drift during current ramp comes from a mixture of transient dissipation and REBCO coil inductance increase when the current penetrates the tapes. These effects are rendered more difficult to evaluate quantitatively for this coil due to the transient coupling currents between the 2 bundled tapes. These are for example responsible for the slight increase of the voltage drift

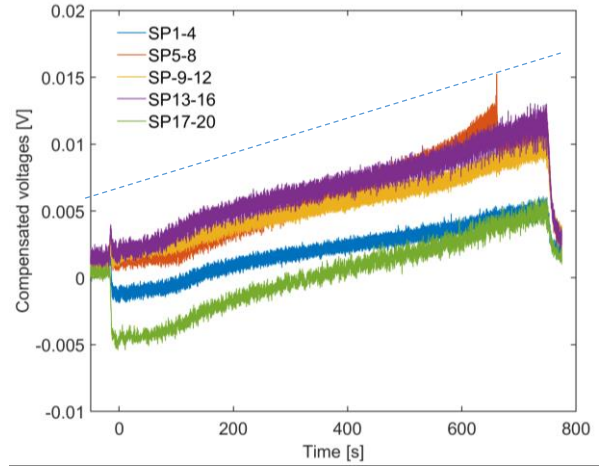

Fig. 6. Compensated voltages (bridge outputs) during self-field ramp up to 300 A at 0.4 A/s. In dotted line a +6 mV offset over the trend of the SP13-16 group

around $t=150$ ms on all 5 signals Fig. 6. More detailed modeling and quantitative comparison will be the object of future works.

Fig. 6, the noise on the signal is very low, so that observing a sudden increase of the voltage due to a dissipating zone in the few-mV range on top of the existing voltage drift trend is straightforward. Fig. 7, large spikes are visible on the signals, corresponding to conductor movement under mechanical stress. Even though such spikes will mostly disappear after the first ramp, they can be an issue to effectively detect dissipation zone during that first ramp, which is the critical one. Indeed a protection based on threshold value in the 10 mV range above the voltage trend would be impractical.

However, when superposing to the end of the voltage trend measured experimentally the simulated dissipating voltage evolution for a very pessimistic case (single local sharp defect with 50 % I_c reduction) as modelled in [8], it is clear that the voltage evolution in case of zone starting to dissipate locally can be distinguished from the noise and spike dynamics. There is however a need for a smarter detection system (in the present experiment it was a human) that can analyze the compensated

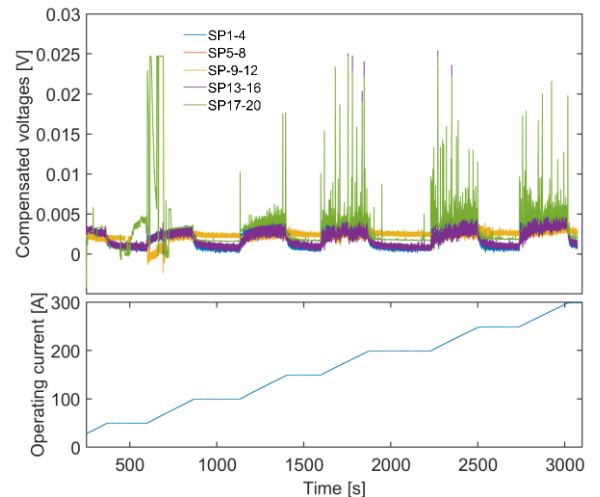

Fig. 7. Ramp to 300 A under 14 T background field. Top: Compensated voltages (bridge outputs). Bottom: current profile.

voltage trend and identify abnormal deviations to trigger a preemptive discharge. It should be noted that even on the last simulated dissipation points (in red on both curves Fig. 8, as derived from [8]) there is enough time to trigger a discharge and prevent the thermal runaway to occur, even taking into account the discharge speed constrains of a full-size insert with a background magnet.

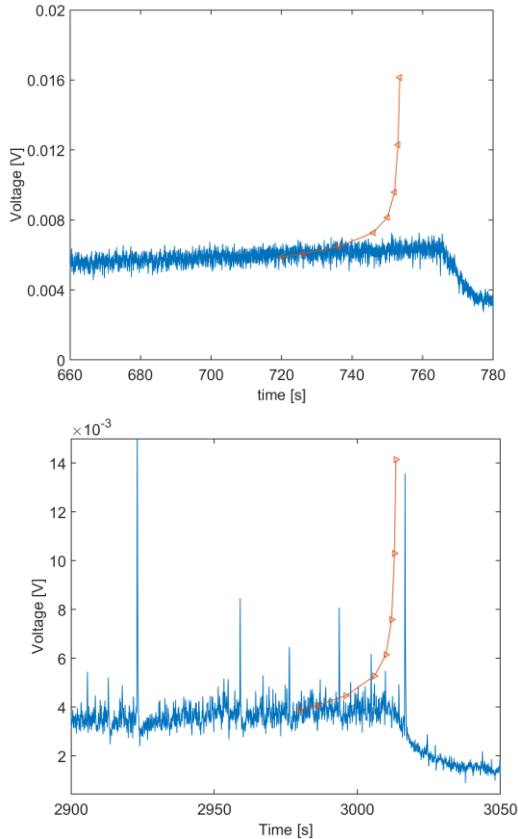

Fig. 8. Top: detail of the end of the ramp at $I=300$ A in self-field. Bottom: Same in background field. For both cases, in blue: experimental measurement of compensated signal at the end of the ramp, across pancakes 1 to 4. In red: simulated quench behavior on a local hotspot gradually losing thermal balance for $I=300$ A [8].

V. CONCLUSION

The robust REBCO insert coil design proposed in earlier work was tested for the first time with a large scale prototype. The combination of several key features such as two-tape bundle conductor, edge impregnation and sensitive thermal runaway onset detection could be validated up to current densities of 244 A/mm^2 and Hoop stress up to 350 MPa with no damage, the prototype generated more than 25 T in a 14 T background field with 20 pancakes. The mechanical stress appeared close to simulated values. The sensitive detection system implemented appear able to give sufficient advance warning of dissipating zone so that thermal runaway could be prevented, though such runaway was not observed due to the large margin and lack of defects. Future works in conduction cooling at higher temperature will be aimed at reducing the margin to reach dissipation and further test the system.

ACKNOWLEDGMENT

The authors would like to thank S. Nimori of National Institute for Materials Science and K. Fushimi of Institute for Materials Research, Tohoku University for their technical assistance with the experiments.

REFERENCES

- [1] S. Awaji *et al.*, "First performance test of a 25 T cryogen-free superconducting magnet," *Supercond. Sci. Technol.*, vol. 30, no. 6, 2017, Art. no. 065001.
- [2] "32 Tesla all-superconducting magnet," [Online]. Available: <https://nationalmaglab.org/magnet-development/magnet-science-technology/magnet-projects/32-tesla-scm>.
- [3] P. Wikus *et al.*, "Commercial gigahertz-class NMR magnets," *Supercond. Sci. Technol.*, vol. 35, 2022, Art. no. 033001.
- [4] Y. Yanagisawa *et al.*, "Review of recent developments in ultra-high field (UHF) NMR magnets in the Asia region," *Supercond. Sci. Technol.*, vol. 35, 2022, Art. no. 044006.
- [5] K. Takahashi *et al.*, "Electromagnetic Characteristics Study of Two-Ply REBCO Tapes Pancake Coils," *IEEE Trans. Appl. Supercond.*, vol. 31, no. 5, 2021, Art. no. 4602305.
- [6] K. Takahashi *et al.*, "Mechanical Properties of Four-Stacked Two Tape Bundled REBCO Pancake Coils," *IEEE Trans. Appl. Supercond.*, vol. 32, no. 6, 2022, Art. no. 8400305.
- [7] S. Awaji *et al.*, "Robust REBCO Insert Coil for Upgrade of 25 T Cryogen-Free Superconducting Magnet," *IEEE Trans. Appl. Supercond.*, vol. 31, no. 5, 2021, Art. no. 4300105.
- [8] A. Badel *et al.*, "Detection and Protection Against Quench/Local Thermal Runaway for a 30 T Cryogen-Free Magnet," *IEEE Trans. Appl. Supercond.*, vol. 31, no. 5, 2021, Art. no. 4700705.
- [9] T. Abe *et al.*, "REBCO Coil With Robust Behavior Against Local Defects Wound Using Two-Tape Bundle," *IEEE Trans. Appl. Supercond.*, vol. 32, no. 6, 2022, Art. no. 4603306.
- [10] S. Awaji *et al.*, "33T cryogen-free superconducting magnet project at HFLSM," presented at App. Supercond. Conf. 2022 (ASC 2022), Hawaii Convention Center, Honolulu, Oct. 23-28, 2022, 1Lor2D-05.
- [11] S. Fujita *et al.*, "Flux-Pinning Properties of BaHfO₃-Doped EuBCO-Coated Conductors Fabricated by Hot-Wall PLD," *IEEE Trans. Appl. Supercond.*, vol. 29, no. 5, 2019, Art. no. 8001505.
- [12] K. Takahashi *et al.*, "Performance test of 20-stacked two-tapes-bundled REBCO pancake coils for upgrading of 25-T cryogen-free superconducting magnet to 30 T" Submitted to *IEEE Trans. Appl. Supercond.*, 2022
- [13] V. D. Arp, "Stresses in Superconducting Solenoids", *J. Appl. Phys.* 48, 2026 (1977)
- [14] J. Vialle *et al.* "A high performance insulated REBCO pancake with conductive cooling capability" Submitted to *IEEE Trans. Appl. Supercond.*, 2022
- [15] Arnaud Badel *et al.* "Modeling of 'quench' or the occurrence and propagation of dissipative zones in REBCO high temperature superconducting coils" *Supercond. Sci. Technol.* 32 094001, 2019
- [16] S. Hahn *et al.*, "HTS Pancake Coils Without Turn-to-Turn Insulation," *IEEE Trans. Appl. Supercond.*, vol. 21, no. 3, 2011, pp. 1592-1595.
- [17] T. L crevisse, and Y. Iwasa, "A (RE)BCO Pancake Winding With Metal-as-Insulation," *IEEE Trans. Appl. Supercond.*, vol. 26, no. 3, 2016, Art. no. 4700405.
- [18] B. Rozier, A. Badel, B. Ramdane and G. Meunier, "Modeling of Dynamic Current Distribution in REBCO Insulated Coils Using a Volume Integral Formulation for Protection Purpose," *IEEE Trans. on Appl. Supercond.*, vol. 29, no. 5, Art no. 4702105, 2019
- [19] J. Vialle *et al.* "Transient voltages and energy balance in REBCO insulated magnet: experimental and numerical studies" *Supercond. Sci. Technol.* 34 115012, 2021
- [20] J. Vialle, A. Badel and P. Tixador, "12 T Insulated REBCO Magnet Used as 1 MJ SMES: Protection Strategies and Preliminary Assembly Tests," *IEEE Trans. Appl. Supercond.*, vol. 32, no. 6, Art no. 4702307, 2022