



**HAL**  
open science

# Evidence of Partial Discharges in the Dielectric Liquid using Electro-Optic Probes

Somya Anand, Eric Vagnon, Martin Guillet

► **To cite this version:**

Somya Anand, Eric Vagnon, Martin Guillet. Evidence of Partial Discharges in the Dielectric Liquid using Electro-Optic Probes. 2022 IEEE Conference on Electrical Insulation and Dielectric Phenomena (CEIDP 2022), Oct 2022, Denver, CO, United States. pp.206-209, 10.1109/CEIDP55452.2022.9985328 . hal-04080766

**HAL Id: hal-04080766**

**<https://hal.science/hal-04080766>**

Submitted on 25 Apr 2023

**HAL** is a multi-disciplinary open access archive for the deposit and dissemination of scientific research documents, whether they are published or not. The documents may come from teaching and research institutions in France or abroad, or from public or private research centers.

L'archive ouverte pluridisciplinaire **HAL**, est destinée au dépôt et à la diffusion de documents scientifiques de niveau recherche, publiés ou non, émanant des établissements d'enseignement et de recherche français ou étrangers, des laboratoires publics ou privés.

# Evidence of Partial Discharges in the Dielectric Liquid using Electro-Optic Probes

Somya Anand

Power Electronics & Converters/Ampère  
SuperGrid Institute/ INSA Lyon,  
69100, Villeurbanne, France  
[somya.anand@insa-lyon.fr](mailto:somya.anand@insa-lyon.fr)

Eric Vagnon

Univ Lyon, Ecole Centrale de  
Lyon, INSA Lyon, Université Lyon1,  
CNRS, Ampère, UMR5005  
69130 Ecully, France  
[eric.vagnon@ec-lyon.fr](mailto:eric.vagnon@ec-lyon.fr)

Martin Guillet

Power Electronics & Converters  
SuperGrid Institute  
69100 Villeurbanne, France  
[martin.guillet@supergrid-institute.com](mailto:martin.guillet@supergrid-institute.com)

**Abstract-** The conventional electrical method of partial discharge (PD) measurement is widely used by several utilities for assessing the quality of insulators. However, its implementation is often limited in the presence of excessive electromagnetic interferences. To overcome this problem, different research teams have been experimenting and investigating alternative PD detectors that are immune to electromagnetic interferences. This paper outlines one such method and presents partial discharge detection using an electro-optic (EO) probe. The work presented here makes use of a needle-barrier plane-configured device under test, filled with a dielectric liquid. The results thus obtained from the electro-optic probe are compared with those obtained from the conventional electrical method. The detection of PD events is found to be reproducible with the EO probe. The phase-resolved partial discharge (PRPD) pattern and the mean partial discharge inception voltage (PDIV) obtained from the EO probe are found to be comparable to those obtained from the electrical method. Also, the PD waveforms acquired from the EO probe are analyzed and have been discussed in this paper. The results show that the electro-optic probe can be a promising alternative for PD detection for a dielectric liquid under a high divergent electric field, without altering the high voltage set-up.

## I. INTRODUCTION

The electrical method described in IEC 60270 standard is widely used to detect partial discharges (PDs) in insulators under laboratory conditions. However, this technique might become insensitive for PD measurements in the presence of high electromagnetic interferences (EMI), such as for online inspections in field conditions [1]. In these circumstances, non-conventional techniques such as optical sensors offering immunity against EMIs and remote sensing can be more beneficial for online condition monitoring of insulators [2-3]. This paper discusses one such technique i.e., electro-optic (EO) probes, which can measure the axial and radial components of the electric field based on the Pockels effect. Some previous works [2]–[5] have shown the implementation of EO probes for flashover detection and defect measurements, but mainly for solid insulators and transformer bushings. This paper demonstrates the PD detection by EO probes in a high divergent electric field for a dielectric liquid.

The EO probe used in this work is based on the principle of the Pockels effect. Some crystals such as BSO and LiTaO<sub>3</sub> change their optical properties in presence of the electric field ‘ $E$ ’ [6]. When a laser beam passes through such a crystal with a refractive index ‘ $n$ ’, an induced birefringence occurs, which is given by,

$$n = n_0 + aE + bE^2 \dots \quad (1)$$

Where,  $n_0$  denotes the natural refractive index.

The Pockels effect defines the linear relationship between the refractive index and the electric field strength; therefore, the quadratic factor ‘ $b$ ’ is zero in (1).

## II. EXPERIMENTAL SET-UP

### A. Device under test (DUT)

The device under test (DUT) used for this test campaign comprised of needle-barrier plane configuration, completely immersed in synthetic ester as shown in Fig. 1. The needle has a tip radius of 1  $\mu\text{m}$  and is connected to the high voltage, whereas the plane with a diameter of 20 mm, is grounded. A 3 mm thick pressboard sample, impregnated in ester act as the barrier. The size of the pressboard sample (40 mm  $\times$  40 mm) is chosen in such a way as to cover the grounding plane in order to avoid flashover during the partial discharge tests. The gap between the needle tip and barrier surface is set at 0.7 mm, controlled using a spacer. The synthetic ester used for the tests was taken from a batch of treated dielectric liquid, with a mean breakdown voltage higher than 75 kV (tested in accordance with IEC 60156) and moisture content less than 130 ppm (measured using coulometric Karl Fischer measurement).

### B. High Voltage generation and PD Measurement circuit

Fig. 2 presents the schematics of the test bench in AC 50 Hz. A PD-free transformer rated at 230 V/24 kV generates the high voltage. A circuit comprising an Arduino board, amplifier, and a small transformer (24 V /230 V) as shown in the schematics controls the output voltage from this transformer.

The electrical detection of PDs is performed by a commercial Omicron set-up, which comprises of coupling capacitor (Ck), a measuring impedance (Zmi), the acquisition system (MPD600 unit), and a transmitter linked to the computer. The optical fiber between the acquisition system and, the transmitter provides

galvanic isolation between the high voltage setup and low voltage area.

The electro-optic measurement system consists of a detecting instrument (eoSense) and two EO probes (longitudinal and transversal) from Kapteos, as shown in Fig. 2. As said earlier, these probes work on the principle of Pockels effect and are sensitive to measuring the electric field as low as 50 mV/m. The bandwidth of the detecting instrument ranges from 1 kHz to 1 GHz, which is ideal for measuring high-frequency signals such as PDs. In this work, only the longitudinal EO probe is used for the electric field measurement occurring from a PD event.

During preliminary tests, the orientation of the longitudinal EO probe is investigated by positioning it perpendicular, parallel, and angularly to the test object. The investigation demonstrated that the angular position, as shown in Fig. 2, provides the best detection of the PDs, hence this orientation of the EO probe is used for further tests. The EO probe is not immersed in the dielectric liquid and is placed just over the DUT cell with the help of a probe holder as can be seen in Fig. 1. The EO probe is linked to its detecting instrument by an optical fiber cable. The 50 Ω output of the detecting instrument (eoSense) connects the acquisition system (MPD 600 unit or an oscilloscope) by a coaxial cable. In this work, at first, the electrical and EO probe measurements are simultaneously done, thanks to two MPD600 units which are linked together as shown in the schematics of Fig. 2. This allowed the acquisition and the study of the phase-resolved partial discharge (PRPD) pattern, recording the PD events and determining the partial discharge inception voltage (PDIV), simultaneously by the two detectors. To study the waveforms acquired from two detectors, the acquisitions were also made with the oscilloscope. The results thus obtained are discussed further in this paper.

For the electrical PD detector, the background noise level is 0.3 pC until 16 kVrms, which is the same value as discussed in our previous paper [7]. With the EO probe, a background noise band of about 50 pa.u. (pico arbitrary unit corresponding to 50 pC on the Omicron chart scale) is noticed. This noise level was found to be unaltered on increasing the voltage level from zero. Fig.3 shows the background noise with the EO probe at 15 kVrms. Due to higher noise level with the EO probe on Omicron chart scale, a threshold of 100 (pC or pa.u.) is used for PDIV determination. For the PD acquisition during the tests, the applied voltage is increased and decreased at the rate of 1 kV/s. A waiting time of 10 s, both at higher and zero voltage is kept before starting the next cycle.

### III. RESULTS

Before launching the tests, the charge calibration of the electrical detector was carried out in compliance with IEC 60270 standard. In the first test, the PDs higher than 100 pC (higher than threshold value) are found to be occurring at about 14-15 kV with the electrical detector. As the objective for the campaign is to verify the PD detection with the EO probe at the inception voltage for chosen threshold, an applied voltage profile with 15 kV as the upper limit is created. This profile is then repeated ten times (see Fig. 4) to ensure the recurrence of the PDs and their synchronized detection by two sensors.



Fig. 1 Photograph of the DUT with needle-pressboard plane configuration filled with ester and the orientation of the EO probe used for PD tests

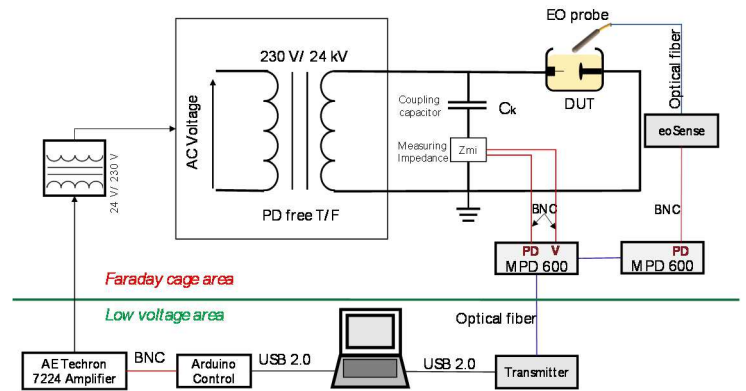

Fig. 2: Schematics of partial discharge test bench in AC 50 Hz with electrical PD detector (Ck and Zmi) and electro-optic probe

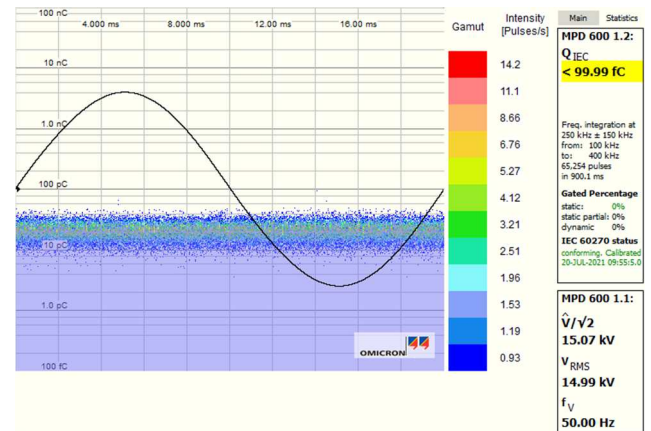

Fig 3: Noise band observed with EO probe when linked to MPD600 unit, without any needle in the DUT at 15 kV

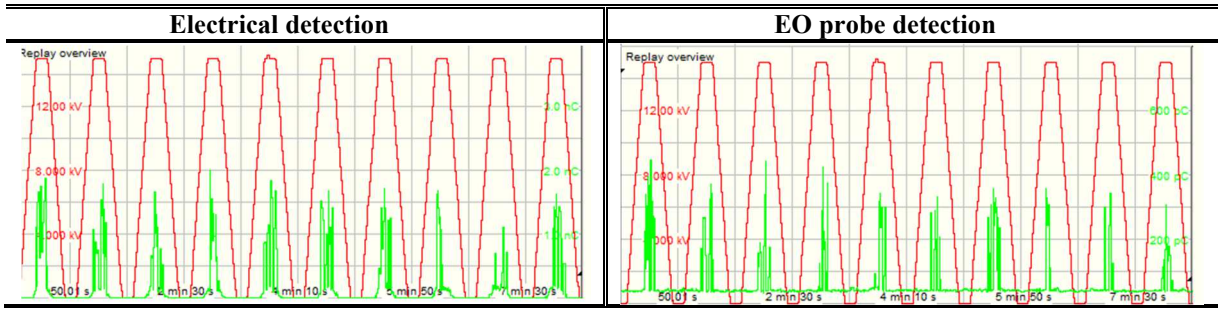

Fig. 4: Synchronized PD detection from electrical (Zmi) and EO sensors

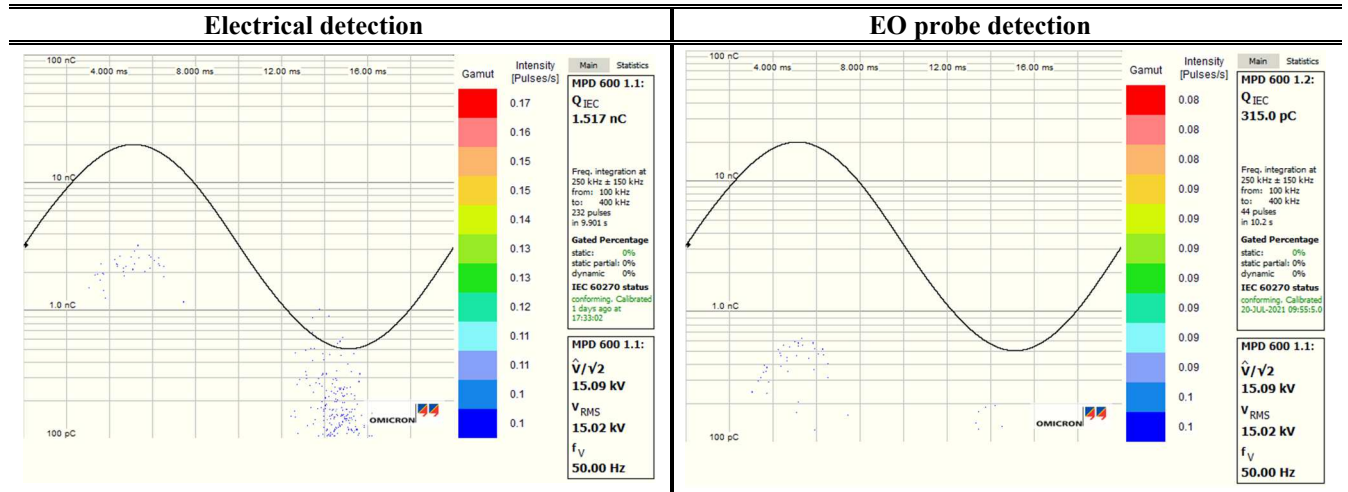

Fig. 5: PRPD patterns acquired from electrical and EO sensors at 15 kV at the same instant

#### A. Synchronized detection of PDs from two different methods

Fig. 4 shows the applied voltage profile in red and PDs in green for ten voltage cycles. As can be seen, the EO sensor detected PDs during all voltage cycles, in the same manner as the electrical method. Most of the PDs can be seen occurring just at the beginning or during the plateau of the voltage cycle. The apparent charge thus acquired by the electrical method corresponds to about 1.5 nC at 15 kV. The same PD events are in the range of 300-400 pa.u as shown by the EO probe.

#### B. Phase-Resolved Partial Discharge (PRPD) pattern

Fig. 5 presents the PRPD pattern obtained from the electrical and EO sensor, acquired after 10 s of waiting time at 15 kV. The PDs less than 100 pC are suppressed to respect the chosen threshold value. Here, it can be observed that, like the electrical detector, the EO probe has also quite well captured the PD cluster in the positive AC cycle. However, in the negative cycle, the EO probe has detected only a few of them. Another point to notice here is that the EO probe shows the PD detection during the same phase angles as those obtained electrically (quite relevant in the positive AC cycle). Additionally, in the tested experimental conditions, it can be seen that the magnitude of PDs acquired by the EO probe is five times lower than those acquired electrically at 15 kV.

#### C. Partial Discharge Inception Voltage (PDIV)

For further analysis, the mean and standard deviation are calculated, using the PDIV data obtained from the recordings of ten measurements. The result thus obtained are presented in Fig. 6. The blue bar shows the average PDIV obtained from electrical measurement (Zmi), whereas the green bar presents that from the EO probe measurement. The graph clearly shows a good correlation in the mean PDIV obtained from two PD detection techniques for the chosen threshold value. The standard deviation bars are small, which is mainly due to the PD occurrences at the beginning or during the plateau of the applied voltage profile.

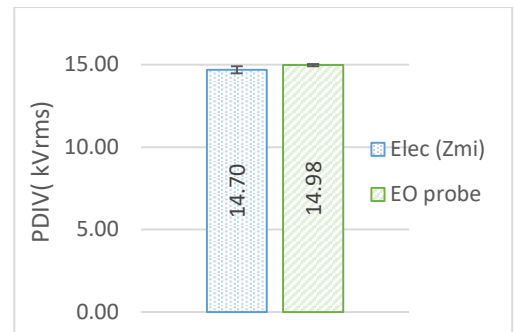

Fig. 6: Mean and standard deviation of ten PDIV measurements from electrical and EO sensor



#### D. Acquisition with Oscilloscope

Next, to study the PD waveforms, the two sensors are linked to the oscilloscope (Tektronix MDO34/bandwidth of 200 MHz). Fig. 7 shows the response of the EO probe at 15 kV without the needle in the DUT. In the absence of any PD occurrence, the EO probe is found to be impacted by a periodically occurring noise. The EO probe does not detect 50 Hz electric field signal due to the bandwidth of the detection system (starting at 1 kHz). With the needle in the DUT, the electrical (Zmi) and EO sensor detected the same discharge events, as presented in Fig. 8.

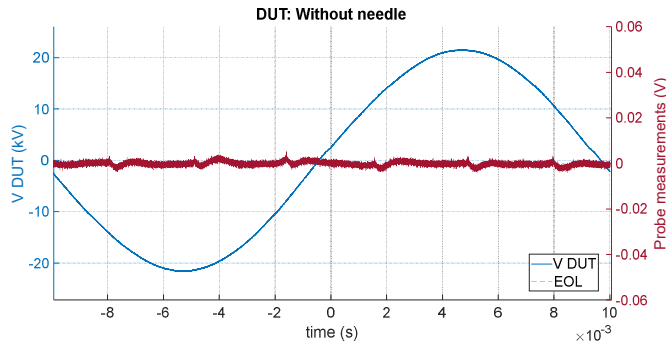

Fig. 7: Response of EO probe at 15 kVrms for DUT without needle

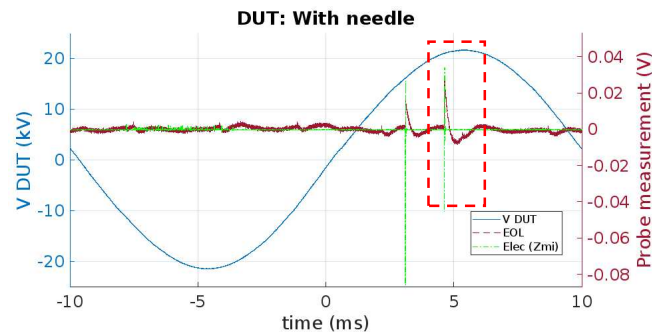

Fig. 8: Response of EO probe (EOL) and electrical sensor (Zmi) at 15 kVrms for DUT with needle

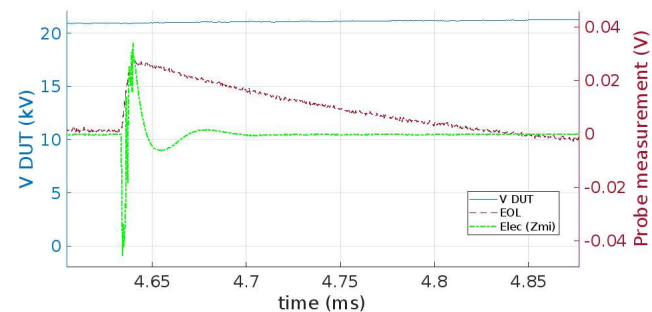

Fig. 9: Magnified view of a PD event detected by EO probe (EOL) and Zmi

Focusing on a single PD event (see Fig. 9), differences can be noticed between the responses from the electrical (Zmi) and the EO sensor. Unlike the short pulse width (usually of few ns) from the electrical sensor, same PD event is characterized by longer fall time (of about 200  $\mu$ s) with the EO sensor. The EO sensor detects the change in the electric field. As soon as a PD

event occurs, the electric field in the electrode gap collapses, leading to a sharp change in the electric field. This part is represented by a very fast rise time by the EO sensor. This event is followed by the charge injection or drift in the electrode gap which influences the electric field distribution in the electrode gap, leading to a longer fall time with the EO probe. Nevertheless, the detection of PDs at the same voltage level is quite evident and comparable from the two PD sensors.

#### IV. CONCLUSION

This paper presented the PD detection using an electro-optic sensor, which works on the principle of the Pockels effect. For the test campaign, a DUT cell filled with synthetic ester is used. A sharp needle with a small gap is used to generate a high divergent field. From the synchronized PD detections, the EO probe is found to be detecting the PDs during the same instant, phase angle and voltage as the conventional electrical detector. With the help of synchronized PD detection, the magnitude of PDs acquired by the EO probe is also estimated for the given experimental conditions. Further, the PD pulse waveforms as acquired by the two detection techniques are also analyzed. It is found that the EO probe shows a sharp change in rise time (few ns), same as the electrical detector during a PD event. However, being an electric field sensor, the EO probe is influenced by the presence of charges in the electrode gap, which alters the electric field distribution, thereby leading to a long fall time with the EO probe. The work presented here demonstrates the relevance of the EO probe for PD detection in a high divergent field for a dielectric liquid and, therefore can be used to investigate the PDIV without interfering the setup arrangement.

#### REFERENCES

- [1] L.E. Ludgaard, "Partial Discharge – Part XIII: Acoustic Partial Discharge Detection- Fundamental Considerations", IEEE Electr. Insul. Magazine, vol. 8, pp.25-31, July/August 1992.
- [2] C. Volat, M. Jabbari, M. Farzaneh, and L. Duvillaret, "New method for in live-line detection of small defects in composite insulator based on electro-optic E-field sensor," IEEE Trans. Dielect. Electr. Insul., vol. 20, no. 1, pp. 194–201, Feb. 2013, doi: 10.1109/TDEI.2013.6451358.
- [3] L. Cui and M. Ramesh, "Prediction of flashover voltage using electric field measurement on clean and polluted insulators," International Journal of Electrical Power & Energy Systems, vol. 116, p. 105574, Mar. 2020, doi: 10.1016/j.ijepes.2019.105574.
- [4] L. Hao, P. Lewin, and S. Dodd, "Extraction of PD Signals from an Electro-optic Modulator Based PD Measurement System," in 2006 IEEE Conference on Electrical Insulation and Dielectric Phenomena, Kansas, MO, USA, Oct. 2006, pp. 623–626. doi: 10.1109/CEIDP.2006.312009.
- [5] Y. Tian, P. L. Lewin, D. Pommerenke, J. S. Wilkinson, and S. J. Sutton, "Partial discharge on-line monitoring for hv cable systems using electrooptic modulators," IEEE Trans. Dielect. Electr. Insul., vol. 11, no. 5, pp. 861–869, Oct. 2004, doi: 10.1109/TDEI.2004.1349792.
- [6] G. Gaborit et al., "A Nonperturbative Electrooptic Sensor for In Situ Electric Discharge Characterization", IEEE Trans. On Plasma Science, vol. 41, pp. 2851-2857, Oct. 2013. doi: 10.1109/TPS.2013.2257874
- [7] S. Anand et.al., "Electrical and optical partial discharge assessment of dielectric barriers in mineral oil and synthetic ester," in 2021 IEEE Electrical Insulation Conference (EIC), Denver, CO, USA, Jun. 2021, pp. 602– 605. doi: 10.1109/EIC49891.2021.9612267.