



**HAL**  
open science

# The Evolution of the South-Eastern Baltic Sea Coastline Between 1988 and 2018 by Remote Sensing

Sébastien Gadal, Thomas Gloaguen

## ► To cite this version:

Sébastien Gadal, Thomas Gloaguen. The Evolution of the South-Eastern Baltic Sea Coastline Between 1988 and 2018 by Remote Sensing. GISTAM 2023 9th International Conference on Geographical Information Systems Theory, Applications and Management, ATHENA Research & Innovation Information Technologies; Setubal Polytechnic University; Universidade Nova de Lisboa, Apr 2023, Prague, Czech Republic. pp.37-47. hal-04080526v1

**HAL Id: hal-04080526**

**<https://hal.science/hal-04080526v1>**

Submitted on 26 Apr 2023 (v1), last revised 26 Apr 2023 (v2)

**HAL** is a multi-disciplinary open access archive for the deposit and dissemination of scientific research documents, whether they are published or not. The documents may come from teaching and research institutions in France or abroad, or from public or private research centers.

L'archive ouverte pluridisciplinaire **HAL**, est destinée au dépôt et à la diffusion de documents scientifiques de niveau recherche, publiés ou non, émanant des établissements d'enseignement et de recherche français ou étrangers, des laboratoires publics ou privés.



Distributed under a Creative Commons Attribution 4.0 International License



## **The Evolution of the South-Eastern Baltic Sea Coastline Between 1988 and 2018 by Remote Sensing**

**Prof. Dr. Sébastien Gadal, Thomas Gloaguen**  
Aix-Marseille University, CNRS, UMR 7300 ESPACE  
Kaunas University of Technology



## Research context

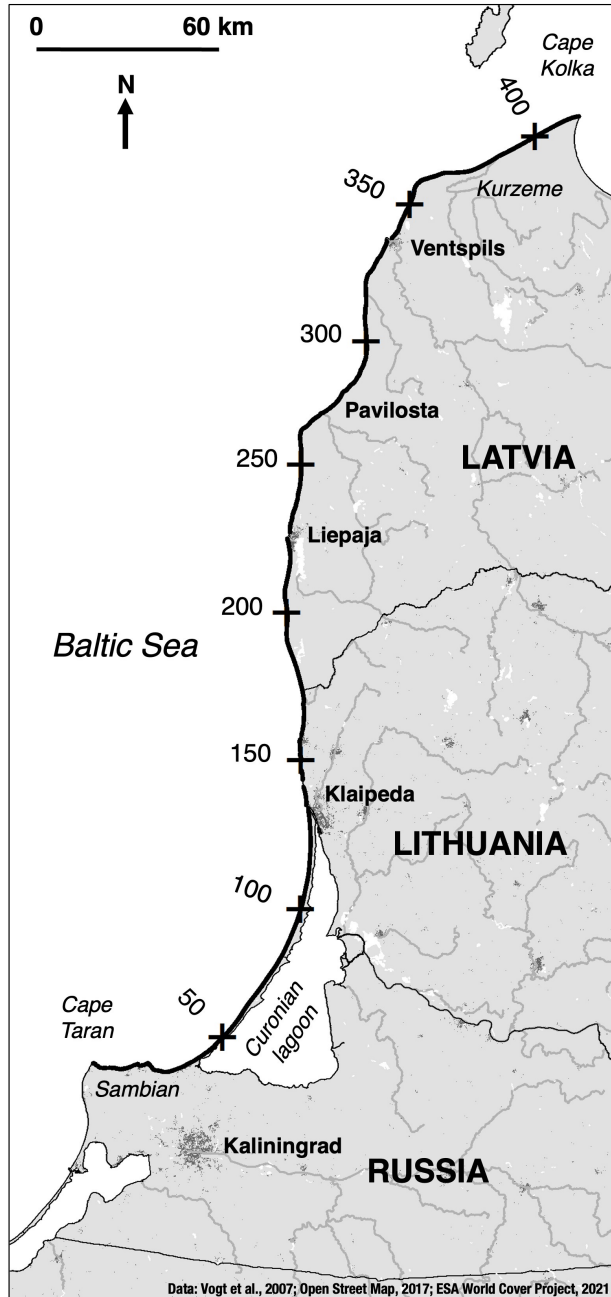

## Research context

- Analysis of coastal dynamics between 1988 and 2018.



## Research context

- Analysis of coastal dynamics between 1988 and 2018.
- The study covers the coasts of Russia (Kaliningrad Oblast), Lithuania and part of Latvia, i.e. 415 kilometres.

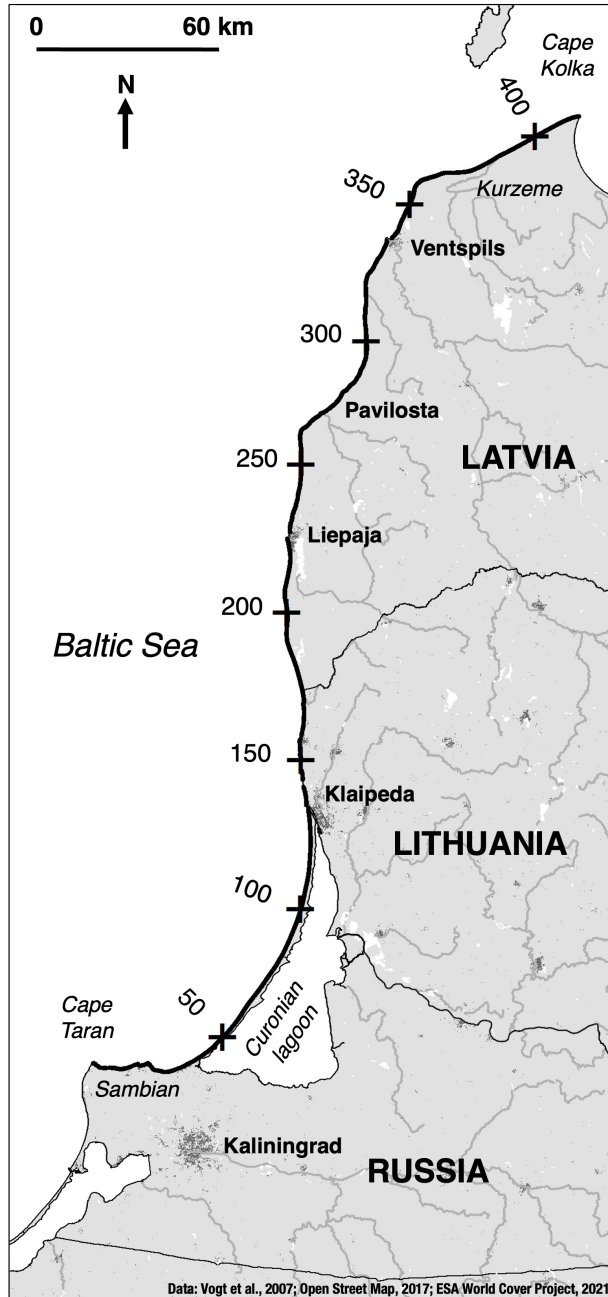

## Research context

- Analysis of coastal dynamics between 1988 and 2018.
- The study covers the coasts of Russia (Kaliningrad Oblast), Lithuania and part of Latvia, i.e. 415 kilometres.
- Use of Landsat 4-5 TM and Landsat 8 OLI satellite image series and remote sensing methods to calculate multi-year change.



## Research context

- Analysis of coastal dynamics between 1988 and 2018.
- The study covers the coasts of Russia (Kaliningrad Oblast), Lithuania and part of Latvia, i.e. 415 kilometres.
- Use of Landsat 4-5 TM and Landsat 8 OLI satellite image series and remote sensing methods to calculate multi-year change.

## Interest of spatial imagery in coastal studies



## Research context

- Analysis of coastal dynamics between 1988 and 2018.
- The study covers the coasts of Russia (Kaliningrad Oblast), Lithuania and part of Latvia, i.e. 415 kilometres.
- Use of Landsat 4-5 TM and Landsat 8 OLI satellite image series and remote sensing methods to calculate multi-year change.

## Interest of spatial imagery in coastal studies

- Coverage of large territories of several thousand kilometres.





## Research context

- Analysis of coastal dynamics between 1988 and 2018.
- The study covers the coasts of Russia (Kaliningrad Oblast), Lithuania and part of Latvia, i.e. 415 kilometres.
- Use of Landsat 4-5 TM and Landsat 8 OLI satellite image series and remote sensing methods to calculate multi-year change.

## Interest of spatial imagery in coastal studies

- Coverage of large territories of several thousand kilometres.
- Historical perspective (Landsat archives since the 1970s).

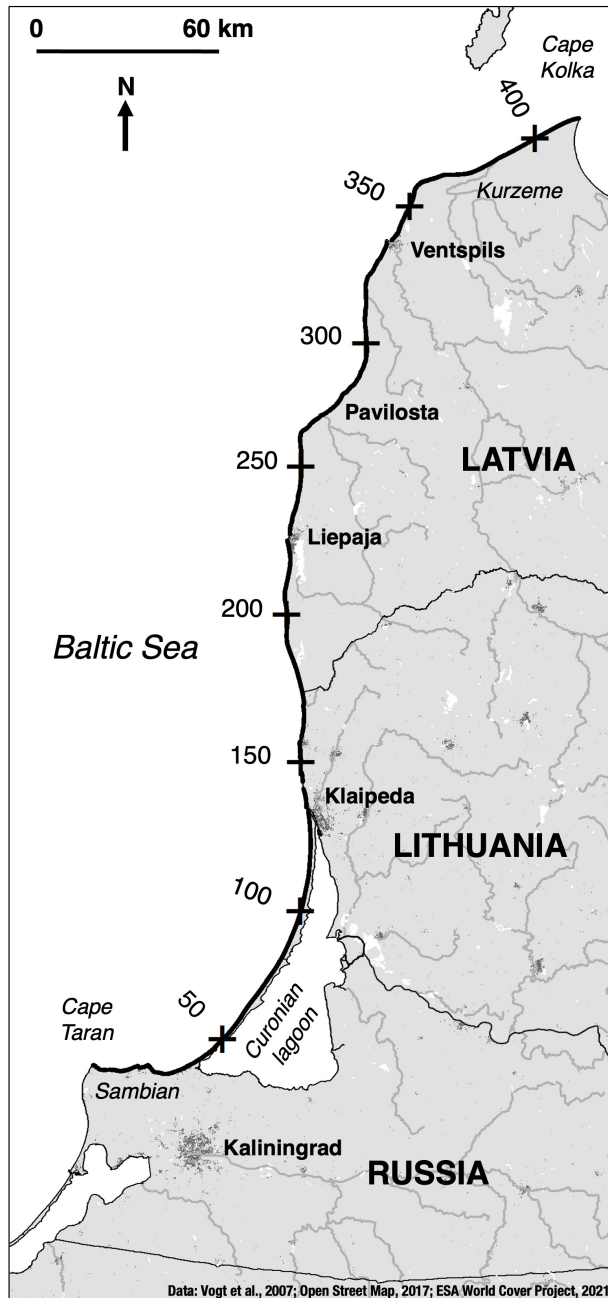

## Research context

- Analysis of coastal dynamics between 1988 and 2018.
- The study covers the coasts of Russia (Kaliningrad Oblast), Lithuania and part of Latvia, i.e. 415 kilometres.
- Use of Landsat 4-5 TM and Landsat 8 OLI satellite image series and remote sensing methods to calculate multi-year change.

## Interest of spatial imagery in coastal studies

- Coverage of large territories of several thousand kilometres.
- Historical perspective (Landsat archives since the 1970s).
- Standardisation of the archives and the measurements.

## Increasing anthropisation of the south-eastern Baltic coastal zone

## Increasing anthropisation of the south-eastern Baltic coastal zone

- Militarisation of the territory during Soviet period: control and limitation of movement and human occupation.



Example of former military infrastructure on the Latvian coast

## Increasing anthropisation of the south-eastern Baltic coastal zone

- Militarisation of the territory during Soviet period: control and limitation of movement and human occupation.
- Independence in the 1990s, associated with a rapid transition to a liberal economic system.



Example of former military infrastructure on the Latvian coast

## Increasing anthropisation of the south-eastern Baltic coastal zone

- Militarisation of the territory during Soviet period: control and limitation of movement and human occupation.
- Independence in the 1990s, associated with a rapid transition to a liberal economic system.
- Economic development combined with land artificialisation: increased human impact on the coast.



Example of former military infrastructure on the Latvian coast



Development of tourism issues in Palanga (Lithuania)

## Increasing anthropisation of the south-eastern Baltic coastal zone

- Militarisation of the territory during Soviet period: control and limitation of movement and human occupation.
- Independence in the 1990s, associated with a rapid transition to a liberal economic system.
- Economic development combined with land artificialisation: increased human impact on the coast.

## Natural characteristics and evolution factors of the coastline



Example of former military infrastructure on the Latvian coast



Development of tourism issues in Palanga (Lithuania)

## Increasing anthropisation of the south-eastern Baltic coastal zone

- Militarisation of the territory during Soviet period: control and limitation of movement and human occupation.
- Independence in the 1990s, associated with a rapid transition to a liberal economic system.
- Economic development combined with land artificialisation: increased human impact on the coast.

## Natural characteristics and evolution factors of the coastline

- Transgression and regression of the ancient Littorina Sea onto Pleistocene and Tertiary glacial deposits.



Example of former military infrastructure on the Latvian coast



Development of tourism issues in Palanga (Lithuania)



## Increasing anthropisation of the south-eastern Baltic coastal zone

- Militarisation of the territory during Soviet period: control and limitation of movement and human occupation.
- Independence in the 1990s, associated with a rapid transition to a liberal economic system.
- Economic development combined with land artificialisation: increased human impact on the coast.

## Natural characteristics and evolution factors of the coastline

- Transgression and regression of the ancient Littorina Sea onto Pleistocene and Tertiary glacial deposits.
- Large sand and gravel beaches and dunes predominate on the coast.



Example of former military infrastructure on the Latvian coast



Development of tourism issues in Palanga (Lithuania)



Coastal landscape of wide sandy beaches in Lithuania

## Increasing anthropisation of the south-eastern Baltic coastal zone

- Militarisation of the territory during Soviet period: control and limitation of movement and human occupation.
- Independence in the 1990s, associated with a rapid transition to a liberal economic system.
- Economic development combined with land artificialisation: increased human impact on the coast.

## Natural characteristics and evolution factors of the coastline

- Transgression and regression of the ancient Littorina Sea onto Pleistocene and Tertiary glacial deposits.
- Large sand and gravel beaches and dunes predominate on the coast.
- Morphodynamics factors: swells, longshore drift, tectonic movements, tidal movements, etc.



Example of former military infrastructure on the Latvian coast



Development of tourism issues in Palanga (Lithuania)



Coastal landscape of wide sandy beaches in Lithuania

## Increasing anthropisation of the south-eastern Baltic coastal zone

- Militarisation of the territory during Soviet period: control and limitation of movement and human occupation.
- Independence in the 1990s, associated with a rapid transition to a liberal economic system.
- Economic development combined with land artificialisation: increased human impact on the coast.

## Natural characteristics and evolution factors of the coastline

- Transgression and regression of the ancient Littorina Sea onto Pleistocene and Tertiary glacial deposits.
- Large sand and gravel beaches and dunes predominate on the coast.
- Morphodynamics factors: swells, longshore drift, tectonic movements, tidal movements, etc.
- The effects of climate variability will modify the current morphological processes.



Example of former military infrastructure on the Latvian coast



Development of tourism issues in Palanga (Lithuania)



Coastal landscape of wide sandy beaches in Lithuania

## Data acquisition

## Data acquisition

- Use of Landsat 4-5 TM and Landsat 8 OLI satellite images composed of spectral bands covering visible and infrared with a resolution of 30 m by 30 m + thermal with a resolution of 100 m by 100 m and 120 m by 120 m (resampled to 30 m by 30 m).

## Data acquisition

- Use of Landsat 4-5 TM and Landsat 8 OLI satellite images composed of spectral bands covering visible and infrared with a resolution of 30 m by 30 m + thermal with a resolution of 100 m by 100 m and 120 m by 120 m (resampled to 30 m by 30 m).
- Spatial resolution of 30 m by 30 m sufficient for long-term change analysis + spectral resolution to use a wide range of electromagnetic measurements.

## Data acquisition

- Use of Landsat 4-5 TM and Landsat 8 OLI satellite images composed of spectral bands covering visible and infrared with a resolution of 30 m by 30 m + thermal with a resolution of 100 m by 100 m and 120 m by 120 m (resampled to 30 m by 30 m).
- Spatial resolution of 30 m by 30 m sufficient for long-term change analysis + spectral resolution to use a wide range of electromagnetic measurements.
- Application of a cloud cover threshold (25%) and a time window (May-June) to limit effects related to storm swells and ice cover.

## Data acquisition

- Use of Landsat 4-5 TM and Landsat 8 OLI satellite images composed of spectral bands covering visible and infrared with a resolution of 30 m by 30 m + thermal with a resolution of 100 m by 100 m and 120 m by 120 m (resampled to 30 m by 30 m).
- Spatial resolution of 30 m by 30 m sufficient for long-term change analysis + spectral resolution to use a wide range of electromagnetic measurements.
- Application of a cloud cover threshold (25%) and a time window (May-June) to limit effects related to storm swells and ice cover.
- Dataset of 12 images: 3 images per decade with regular intervals (1988, 1999, 2009 and 2018).



## Data acquisition

- Use of Landsat 4-5 TM and Landsat 8 OLI satellite images composed of spectral bands covering visible and infrared with a resolution of 30 m by 30 m + thermal with a resolution of 100 m by 100 m and 120 m by 120 m (resampled to 30 m by 30 m).
- Spatial resolution of 30 m by 30 m sufficient for long-term change analysis + spectral resolution to use a wide range of electromagnetic measurements.
- Application of a cloud cover threshold (25%) and a time window (May-June) to limit effects related to storm swells and ice cover.
- Dataset of 12 images: 3 images per decade with regular intervals (1988, 1999, 2009 and 2018).

## 2 methods of coastline extraction

## Data acquisition

- Use of Landsat 4-5 TM and Landsat 8 OLI satellite images composed of spectral bands covering visible and infrared with a resolution of 30 m by 30 m + thermal with a resolution of 100 m by 100 m and 120 m by 120 m (resampled to 30 m by 30 m).
- Spatial resolution of 30 m by 30 m sufficient for long-term change analysis + spectral resolution to use a wide range of electromagnetic measurements.
- Application of a cloud cover threshold (25%) and a time window (May-June) to limit effects related to storm swells and ice cover.
- Dataset of 12 images: 3 images per decade with regular intervals (1988, 1999, 2009 and 2018).

## 2 methods of coastline extraction

- (1) By photointerpretation.

## Data acquisition

- Use of Landsat 4-5 TM and Landsat 8 OLI satellite images composed of spectral bands covering visible and infrared with a resolution of 30 m by 30 m + thermal with a resolution of 100 m by 100 m and 120 m by 120 m (resampled to 30 m by 30 m).
- Spatial resolution of 30 m by 30 m sufficient for long-term change analysis + spectral resolution to use a wide range of electromagnetic measurements.
- Application of a cloud cover threshold (25%) and a time window (May-June) to limit effects related to storm swells and ice cover.
- Dataset of 12 images: 3 images per decade with regular intervals (1988, 1999, 2009 and 2018).

## 2 methods of coastline extraction

- (1) By photointerpretation.

Spectral bands  
Blue, SWIR,  
Near-Infrared

## Data acquisition

- Use of Landsat 4-5 TM and Landsat 8 OLI satellite images composed of spectral bands covering visible and infrared with a resolution of 30 m by 30 m + thermal with a resolution of 100 m by 100 m and 120 m by 120 m (resampled to 30 m by 30 m).
- Spatial resolution of 30 m by 30 m sufficient for long-term change analysis + spectral resolution to use a wide range of electromagnetic measurements.
- Application of a cloud cover threshold (25%) and a time window (May-June) to limit effects related to storm swells and ice cover.
- Dataset of 12 images: 3 images per decade with regular intervals (1988, 1999, 2009 and 2018).

## 2 methods of coastline extraction

- (1) By photointerpretation.

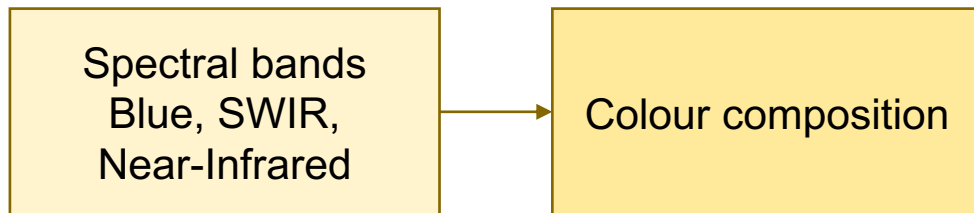

## Data acquisition

- Use of Landsat 4-5 TM and Landsat 8 OLI satellite images composed of spectral bands covering visible and infrared with a resolution of 30 m by 30 m + thermal with a resolution of 100 m by 100 m and 120 m by 120 m (resampled to 30 m by 30 m).
- Spatial resolution of 30 m by 30 m sufficient for long-term change analysis + spectral resolution to use a wide range of electromagnetic measurements.
- Application of a cloud cover threshold (25%) and a time window (May-June) to limit effects related to storm swells and ice cover.
- Dataset of 12 images: 3 images per decade with regular intervals (1988, 1999, 2009 and 2018).

## 2 methods of coastline extraction

- (1) By photointerpretation.

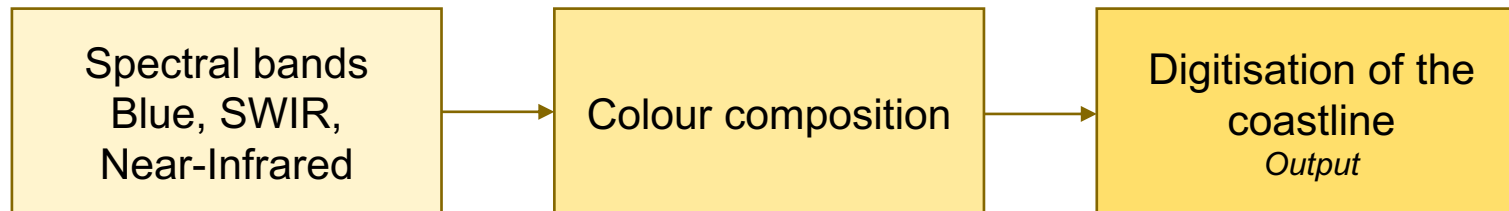

## Data acquisition

- Use of Landsat 4-5 TM and Landsat 8 OLI satellite images composed of spectral bands covering visible and infrared with a resolution of 30 m by 30 m + thermal with a resolution of 100 m by 100 m and 120 m by 120 m (resampled to 30 m by 30 m).
- Spatial resolution of 30 m by 30 m sufficient for long-term change analysis + spectral resolution to use a wide range of electromagnetic measurements.
- Application of a cloud cover threshold (25%) and a time window (May-June) to limit effects related to storm swells and ice cover.
- Dataset of 12 images: 3 images per decade with regular intervals (1988, 1999, 2009 and 2018).

## 2 methods of coastline extraction

- (1) By photointerpretation.

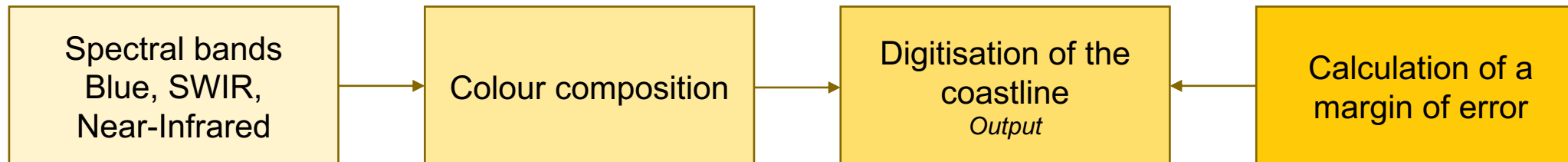

## Data acquisition

- Use of Landsat 4-5 TM and Landsat 8 OLI satellite images composed of spectral bands covering visible and infrared with a resolution of 30 m by 30 m + thermal with a resolution of 100 m by 100 m and 120 m by 120 m (resampled to 30 m by 30 m).
- Spatial resolution of 30 m by 30 m sufficient for long-term change analysis + spectral resolution to use a wide range of electromagnetic measurements.
- Application of a cloud cover threshold (25%) and a time window (May-June) to limit effects related to storm swells and ice cover.
- Dataset of 12 images: 3 images per decade with regular intervals (1988, 1999, 2009 and 2018).

## 2 methods of coastline extraction

- (1) By photointerpretation.

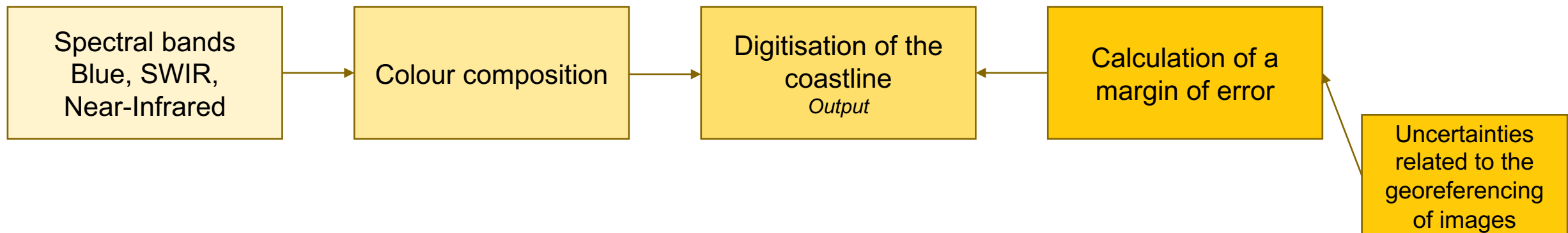

## Data acquisition

- Use of Landsat 4-5 TM and Landsat 8 OLI satellite images composed of spectral bands covering visible and infrared with a resolution of 30 m by 30 m + thermal with a resolution of 100 m by 100 m and 120 m by 120 m (resampled to 30 m by 30 m).
- Spatial resolution of 30 m by 30 m sufficient for long-term change analysis + spectral resolution to use a wide range of electromagnetic measurements.
- Application of a cloud cover threshold (25%) and a time window (May-June) to limit effects related to storm swells and ice cover.
- Dataset of 12 images: 3 images per decade with regular intervals (1988, 1999, 2009 and 2018).

## 2 methods of coastline extraction

- (1) By photointerpretation.

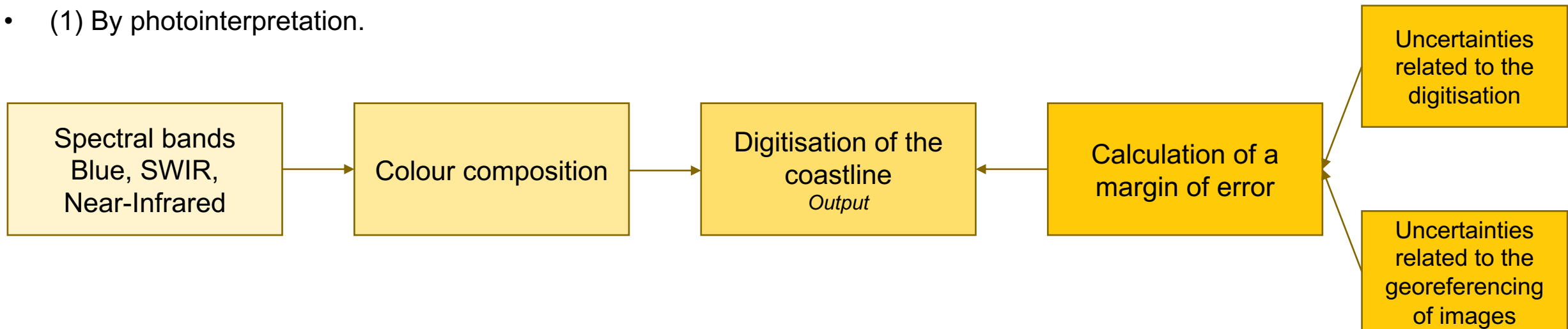



## 2 methods of coastline extraction

- (2) By transformation and enhancement of satellite images.

## 2 methods of coastline extraction

- (2) By transformation and enhancement of satellite images.

Spectral bands  
Visible, Infrared and  
Thermal

## 2 methods of coastline extraction

- (2) By transformation and enhancement of satellite images.

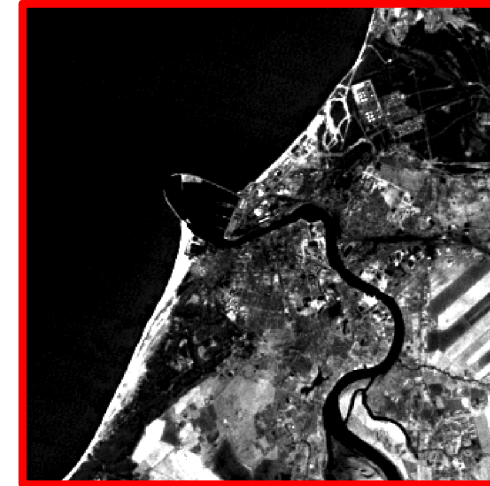
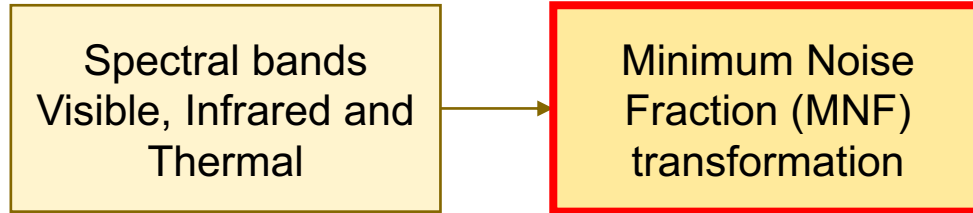

## 2 methods of coastline extraction

- (2) By transformation and enhancement of satellite images.

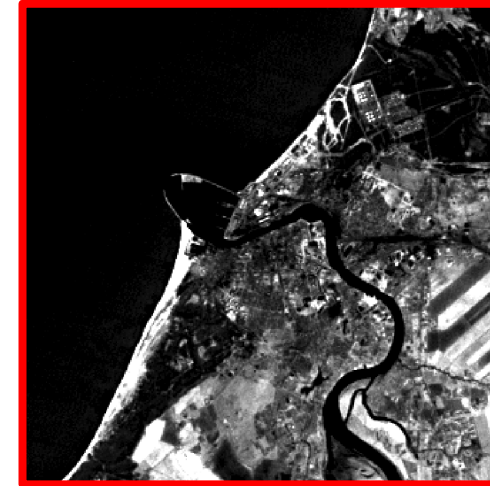
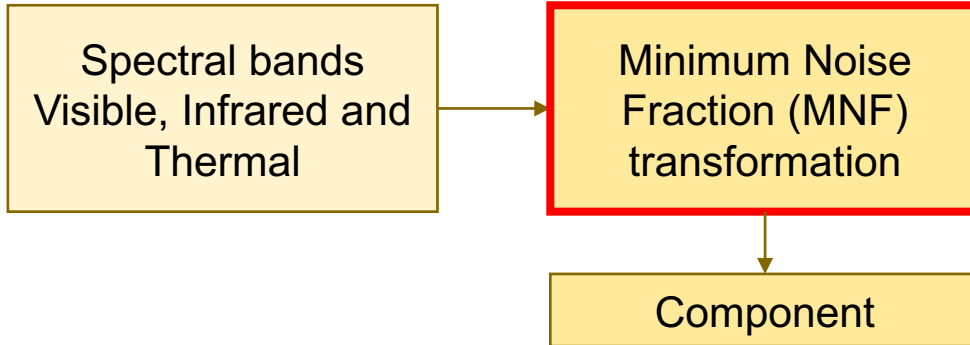

## 2 methods of coastline extraction

- (2) By transformation and enhancement of satellite images.

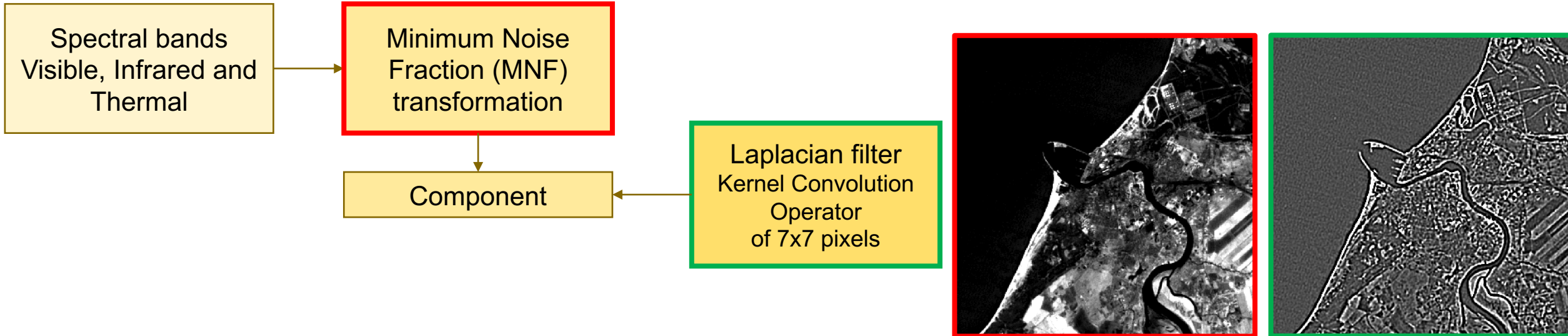

## 2 methods of coastline extraction

- (2) By transformation and enhancement of satellite images.

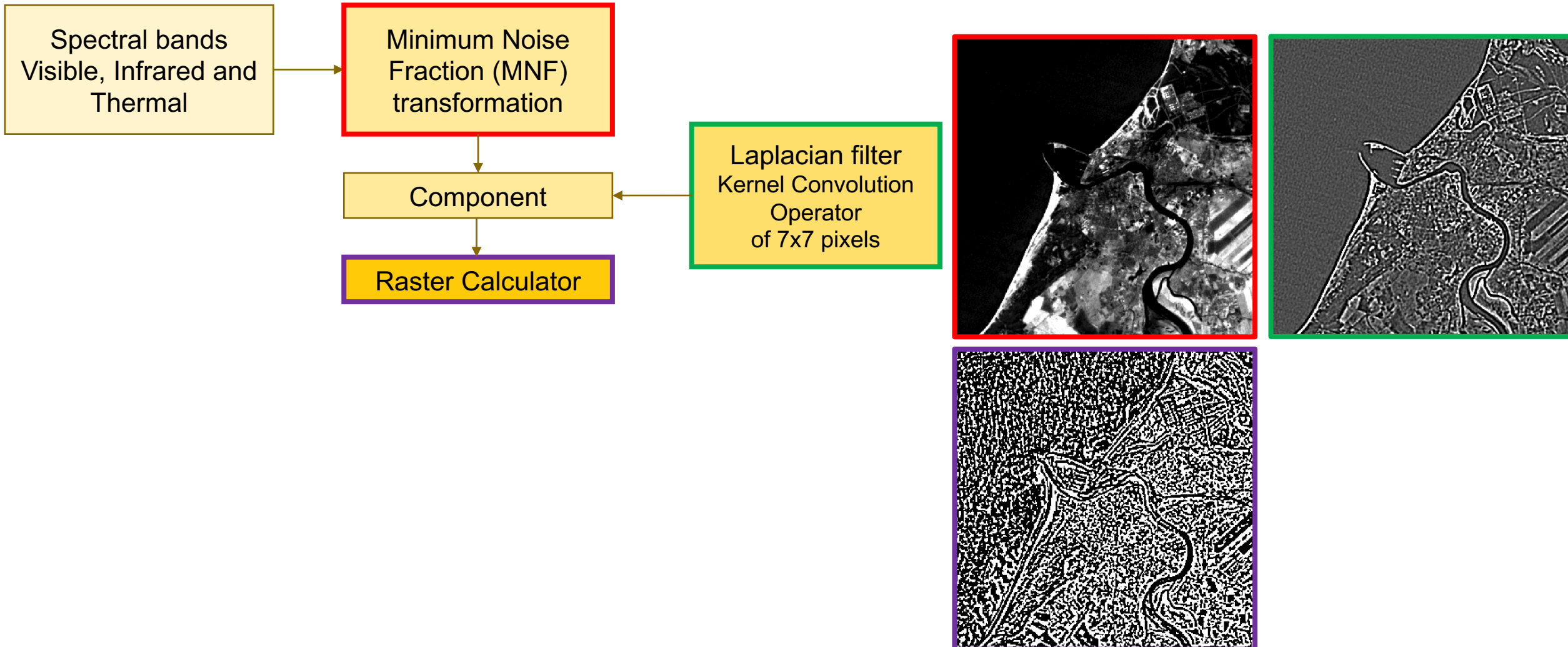

## 2 methods of coastline extraction

- (2) By transformation and enhancement of satellite images.

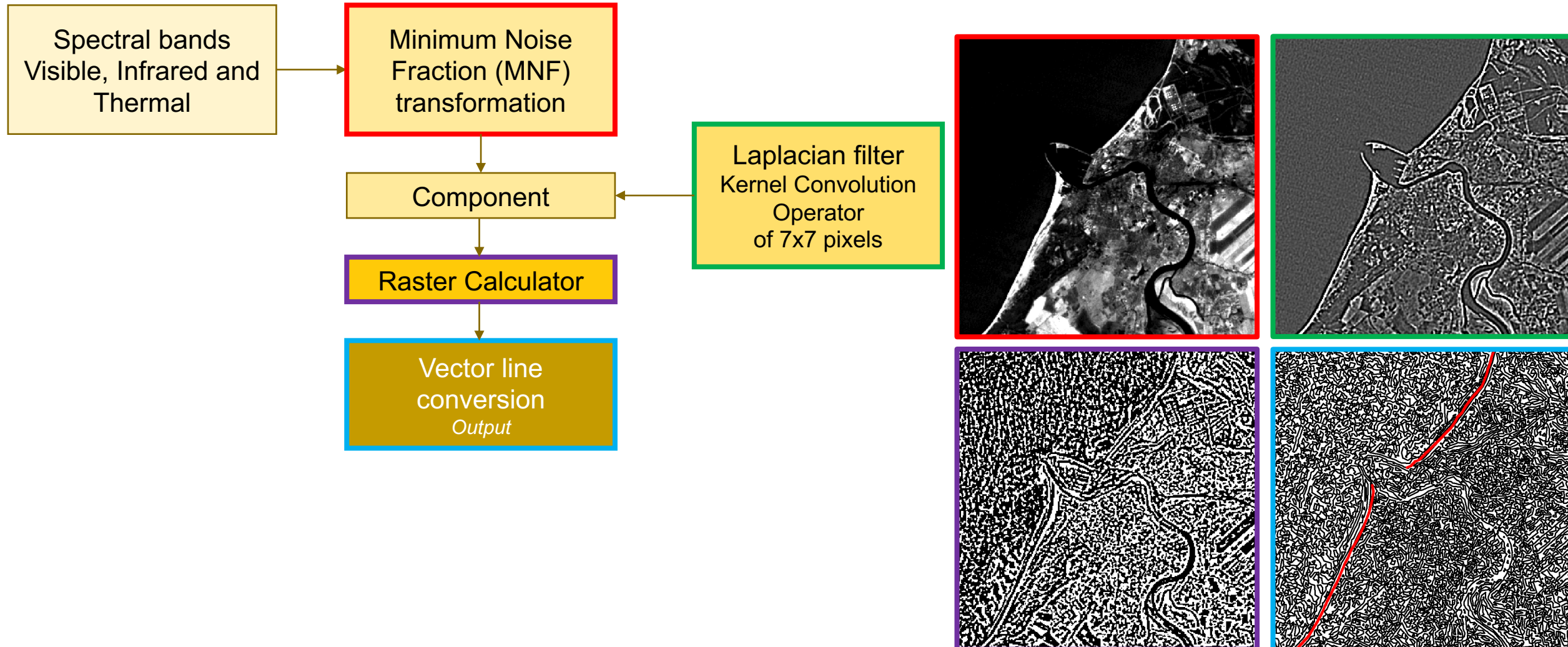

## 2 methods of coastline extraction

- (2) By transformation and enhancement of satellite images.

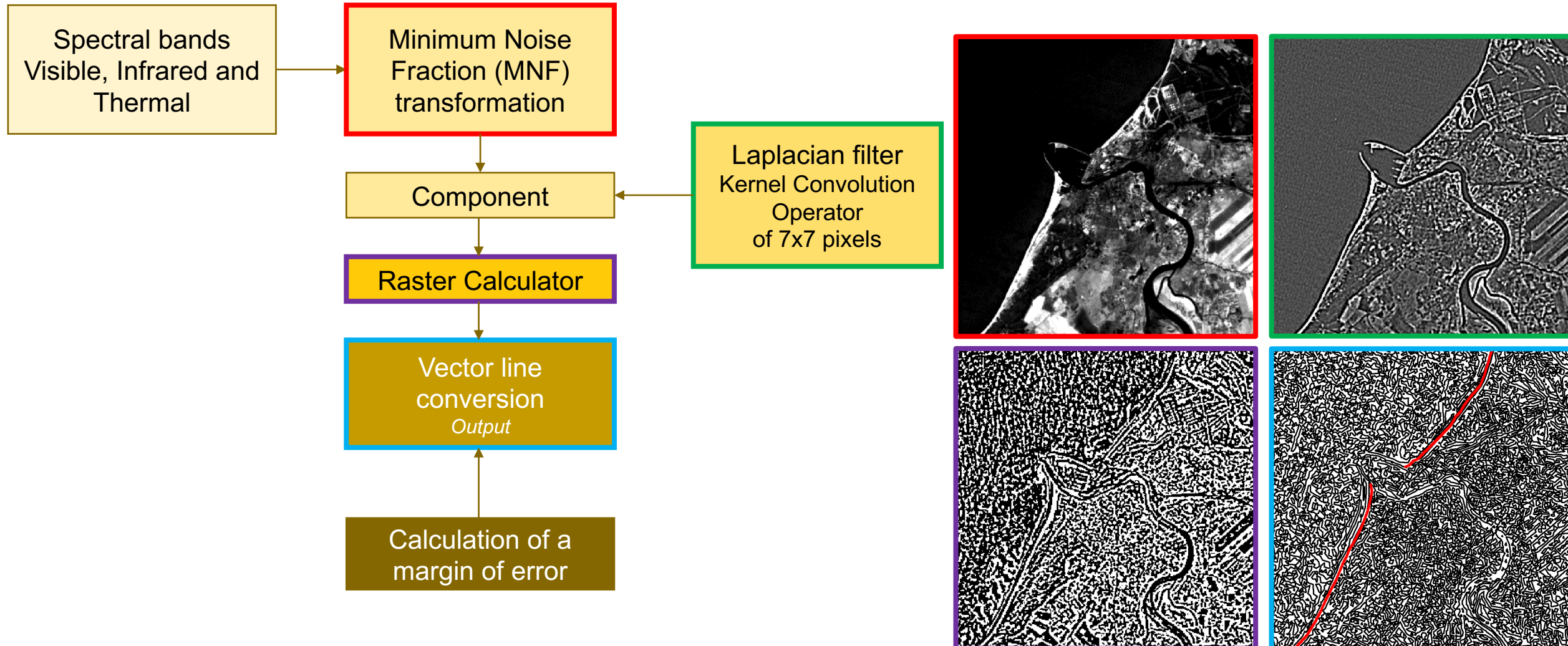



## 2 methods of coastline extraction

- (2) By transformation and enhancement of satellite images.

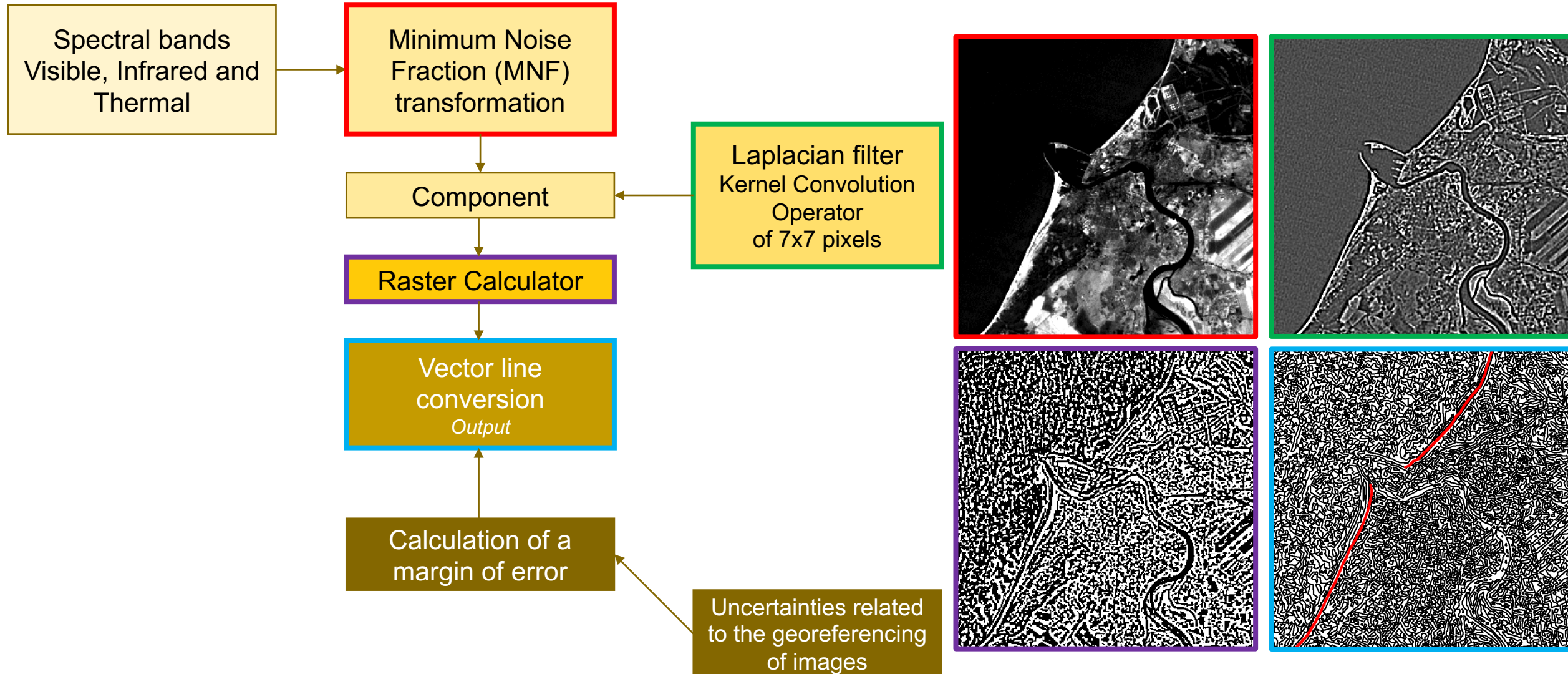

## 2 methods of coastline extraction

- (2) By transformation and enhancement of satellite images.

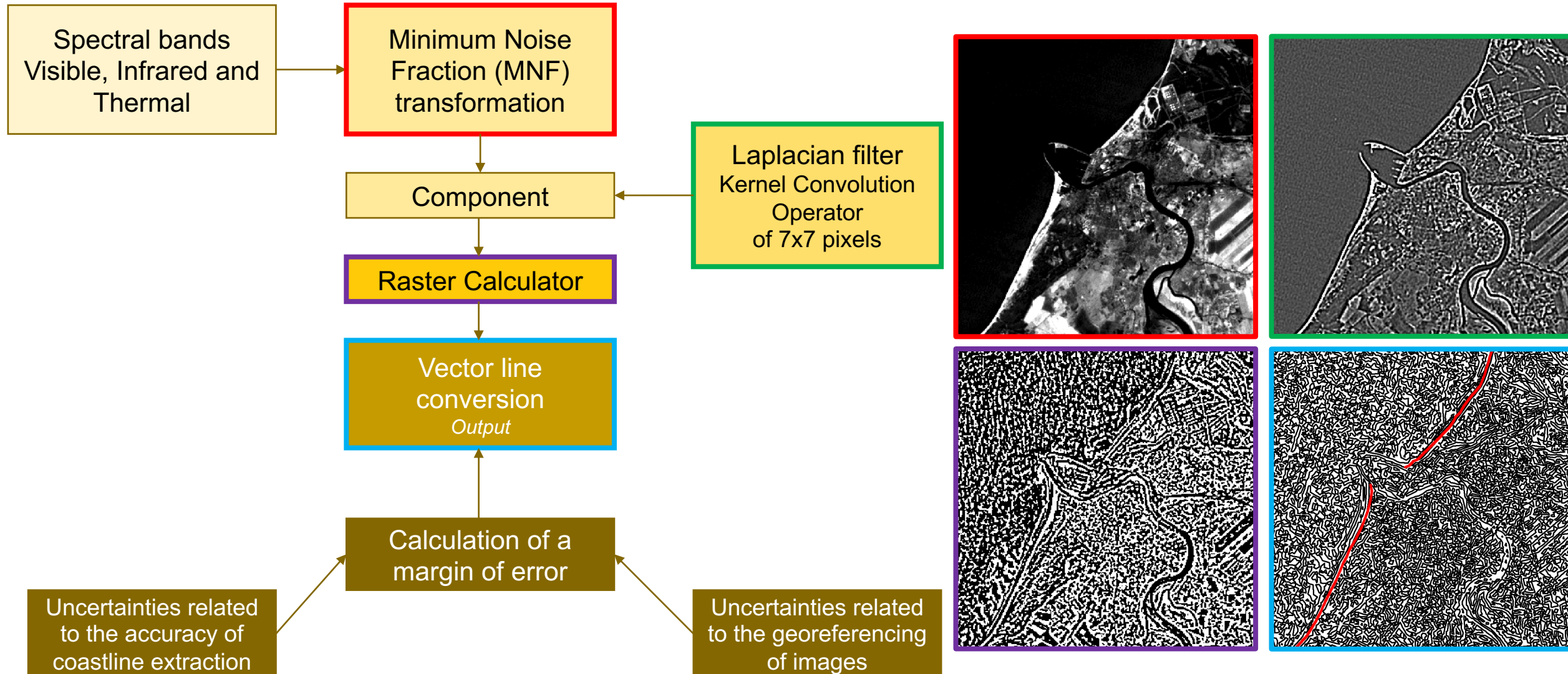

## 2 methods of coastline extraction

- (2) By transformation and enhancement of satellite images.

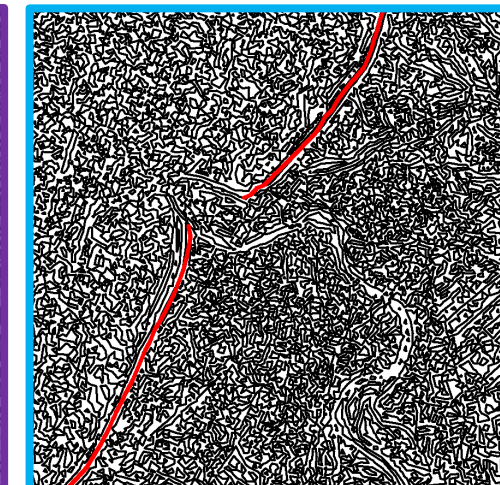
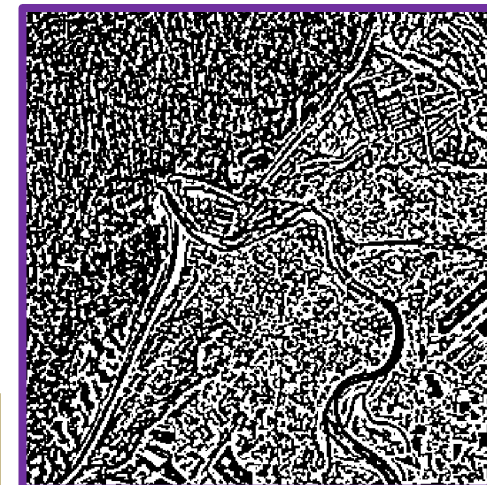
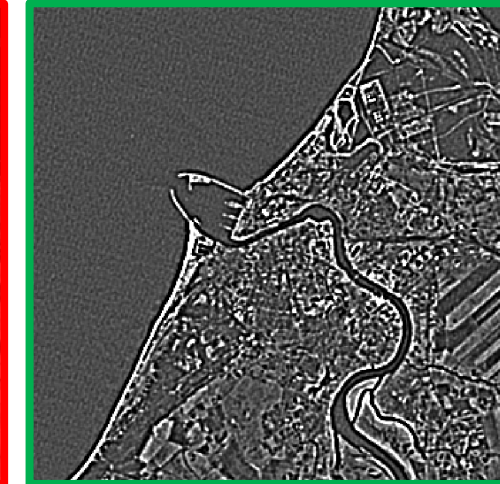
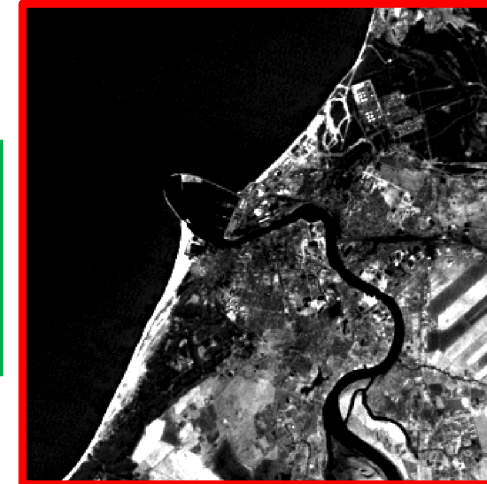
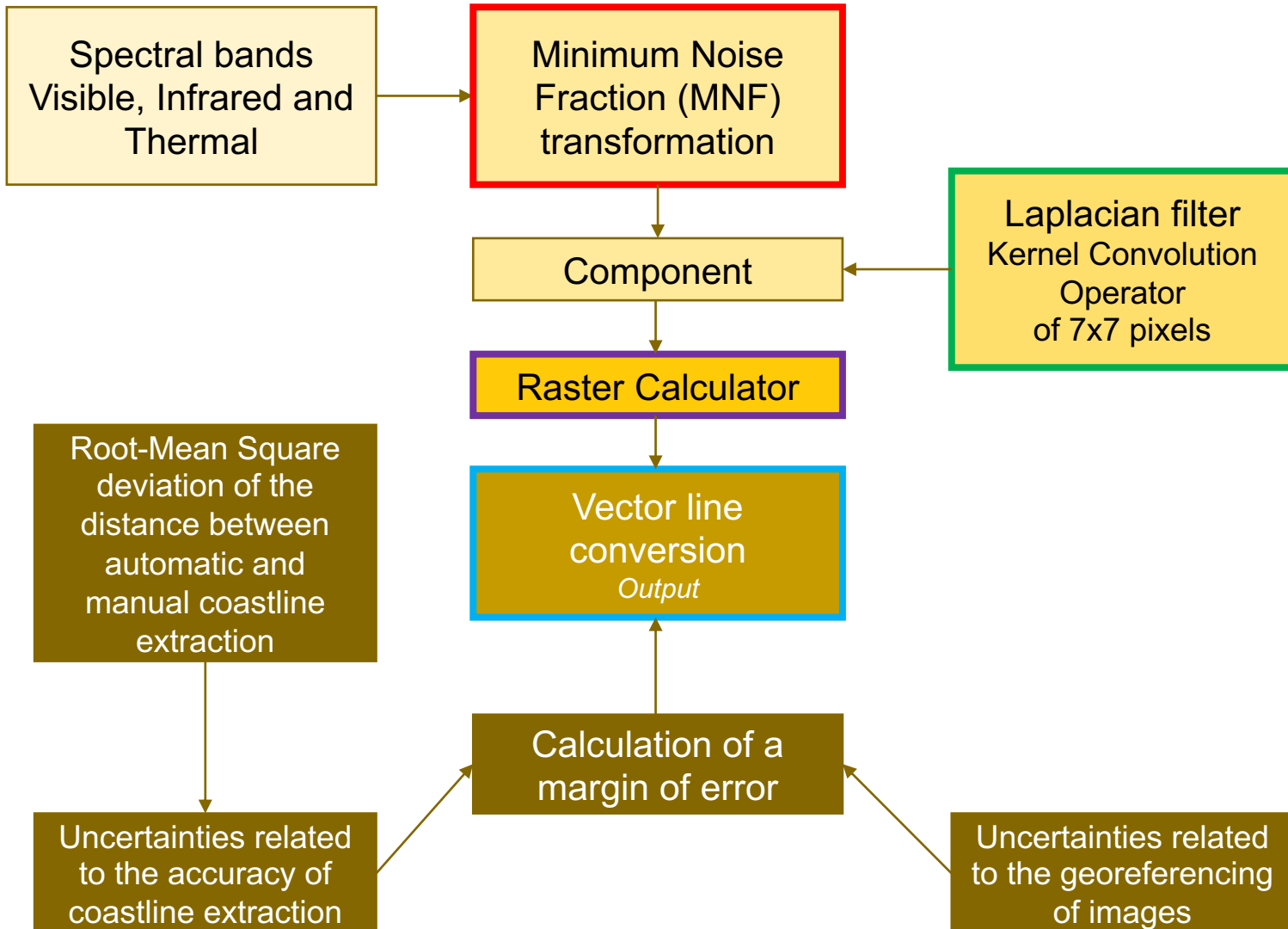

## **Statistical analysis of historical shoreline variation**

## Statistical analysis of historical shoreline variation

- Use of the DSAS tool on ArcGIS for shoreline evolution calculations.

## Statistical analysis of historical shoreline variation

- Use of the DSAS tool on ArcGIS for shoreline evolution calculations.
- Calculations are based on the distance between a reference line and different digitised linear objects using transects defined at regular intervals.

## Statistical analysis of historical shoreline variation

- Use of the DSAS tool on ArcGIS for shoreline evolution calculations.
- Calculations are based on the distance between a reference line and different digitised linear objects using transects defined at regular intervals.
- End Point Rate: ratio of net change to time difference of oldest and most recent measurements. Does not consider intermediate changes.

## Statistical analysis of historical shoreline variation

- Use of the DSAS tool on ArcGIS for shoreline evolution calculations.
- Calculations are based on the distance between a reference line and different digitised linear objects using transects defined at regular intervals.
- End Point Rate: ratio of net change to time difference of oldest and most recent measurements. Does not consider intermediate changes.
- Linear Regression Rate: the annual rate of change of the coastline position from a least-squares regression line.

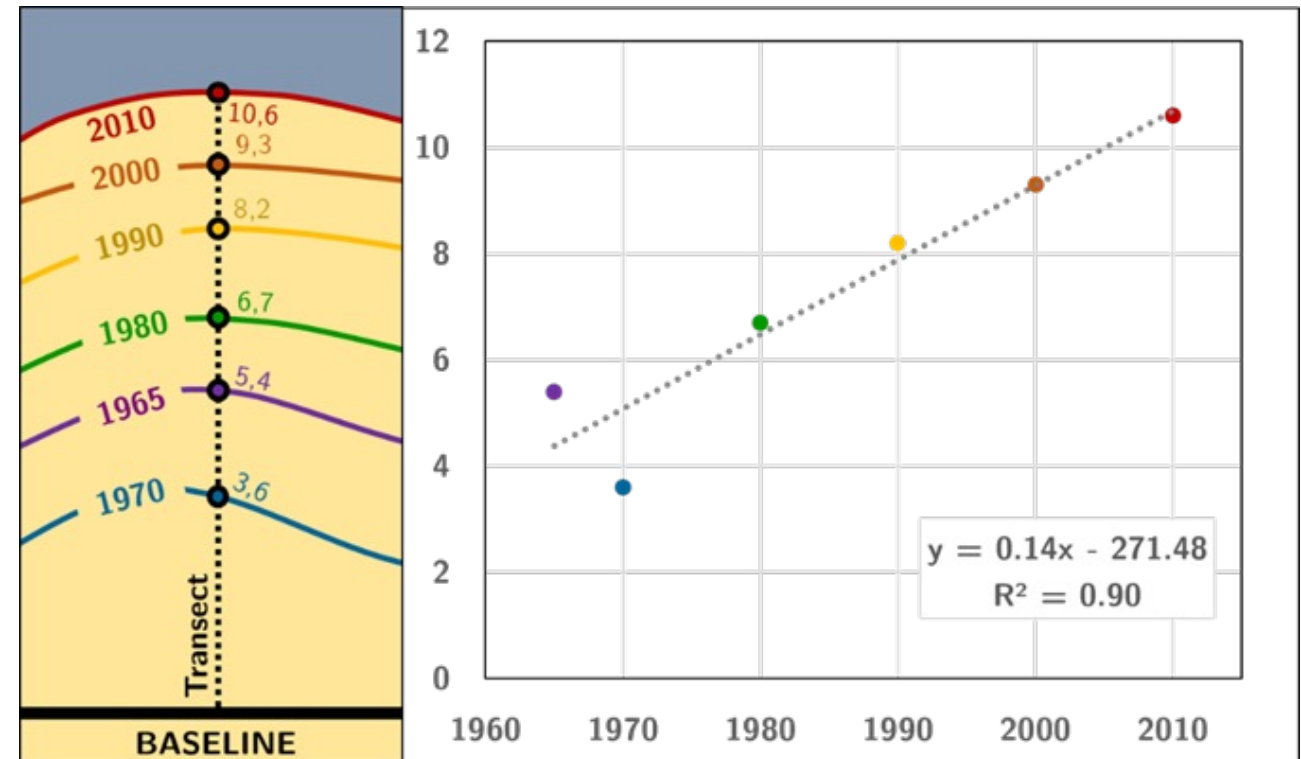

Thieler et al., 2018



## Statistical analysis of historical shoreline variation

- Use of the DSAS tool on ArcGIS for shoreline evolution calculations.
- Calculations are based on the distance between a reference line and different digitised linear objects using transects defined at regular intervals.
- End Point Rate: ratio of net change to time difference of oldest and most recent measurements. Does not consider intermediate changes.
- Linear Regression Rate: the annual rate of change of the coastline position from a least-squares regression line.
- Weight Linear Regression: same principle but considering margins of error in the calculation.

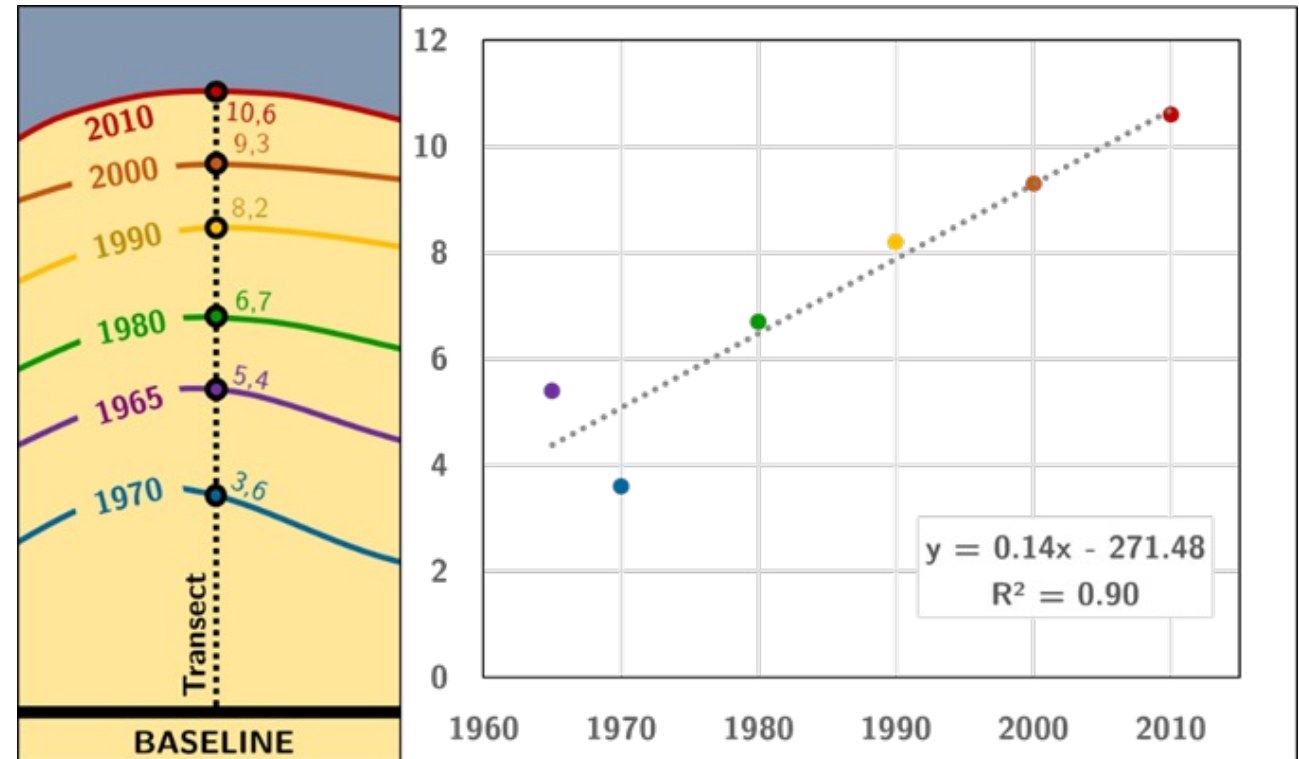

Thieler et al., 2018

## An intra-period evolution characterised by a great stability of the coastline

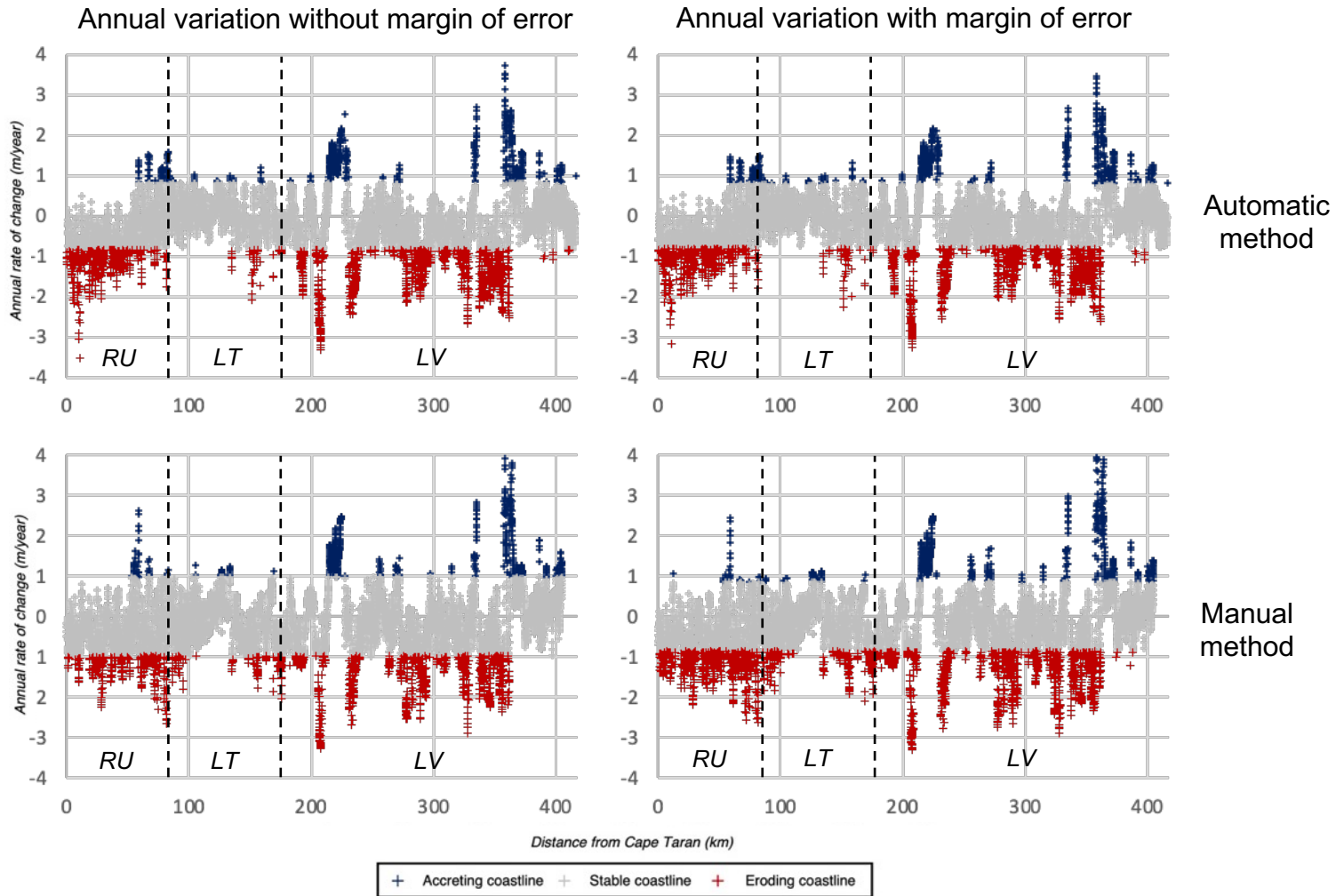

## An intra-period evolution characterised by a great stability of the coastline

- Between 1988 and 2018, the south-eastern Baltic coast is characterised by overall stability.

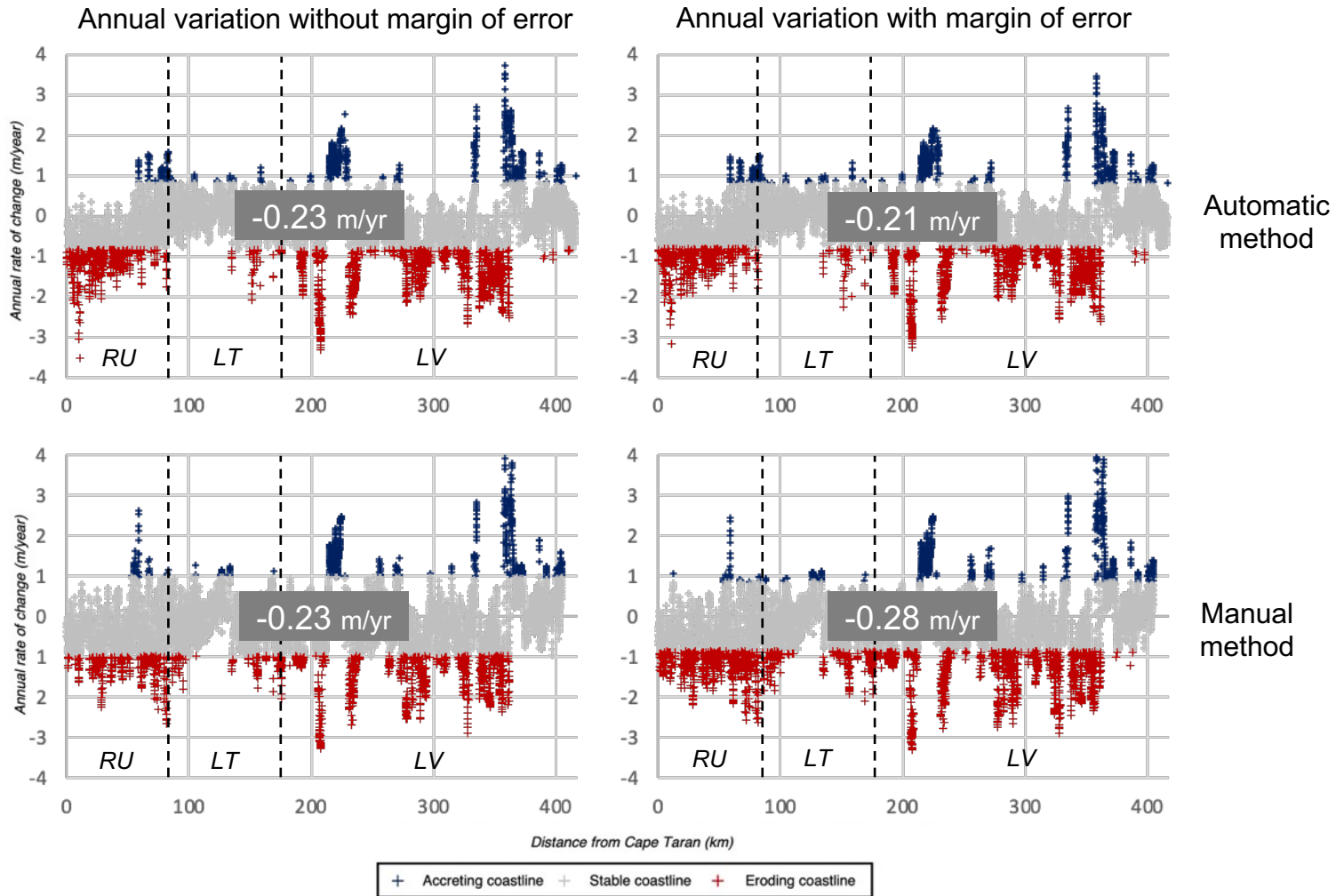

## An intra-period evolution characterised by a great stability of the coastline

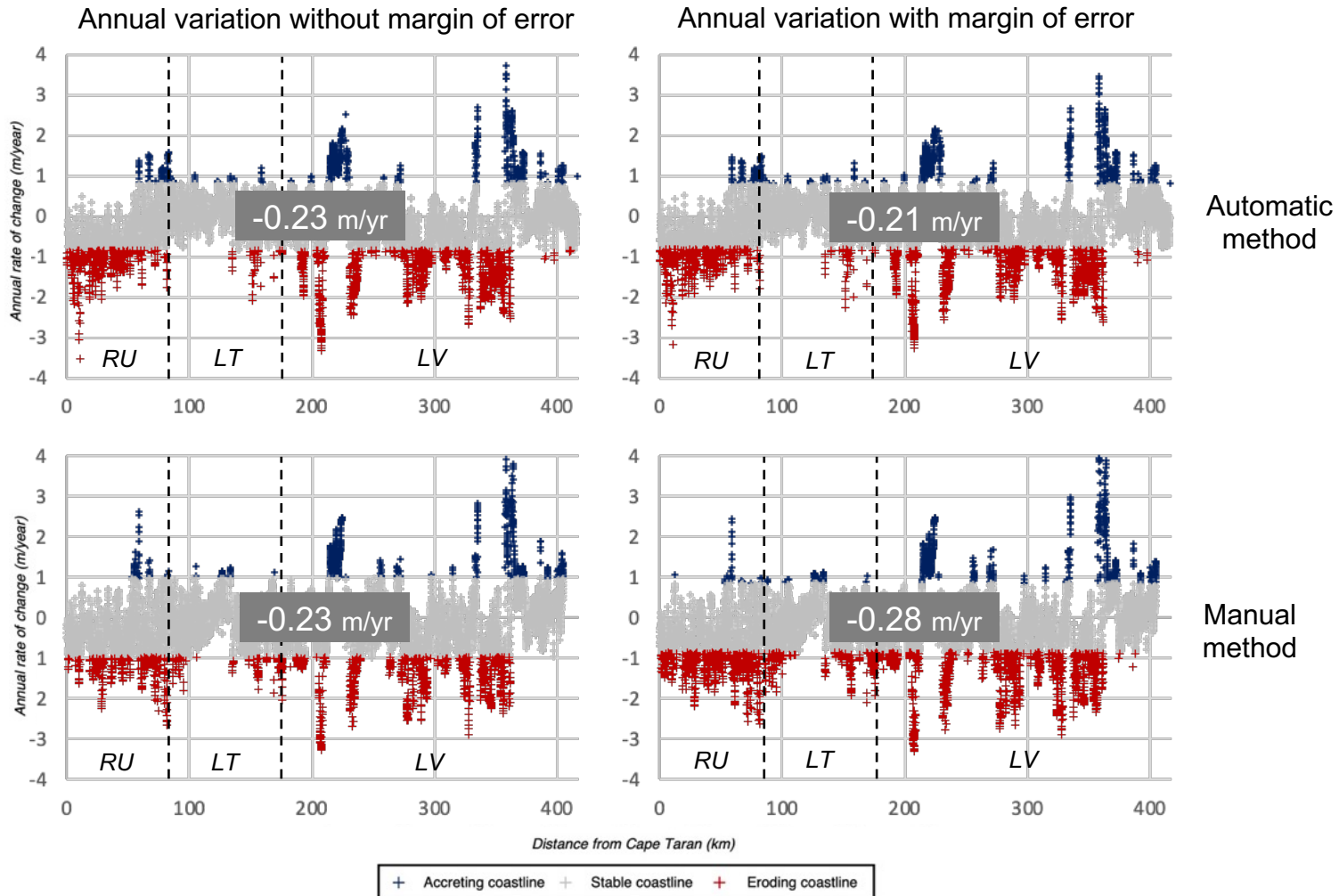

- Between 1988 and 2018, the south-eastern Baltic coast is characterised by overall stability.
- A manual method more sensitive to margins of error.

## An intra-period evolution characterised by a great stability of the coastline

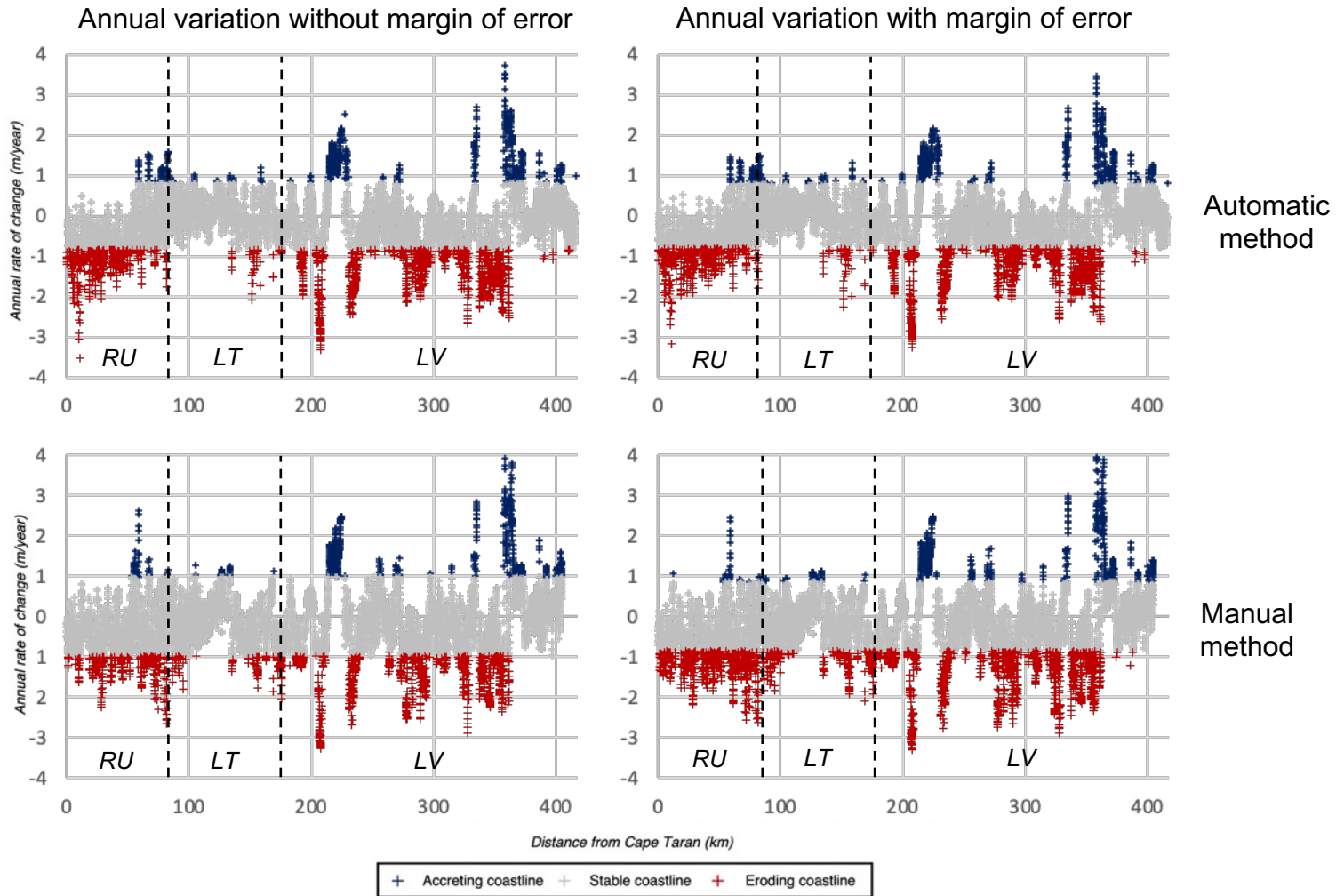

- Between 1988 and 2018, the south-eastern Baltic coast is characterised by overall stability.
- A manual method more sensitive to margins of error.
- 30% of the coastline presents a significantly regular evolution trend in time and space, whatever the extraction method.

## An intra-period evolution characterised by a great stability of the coastline

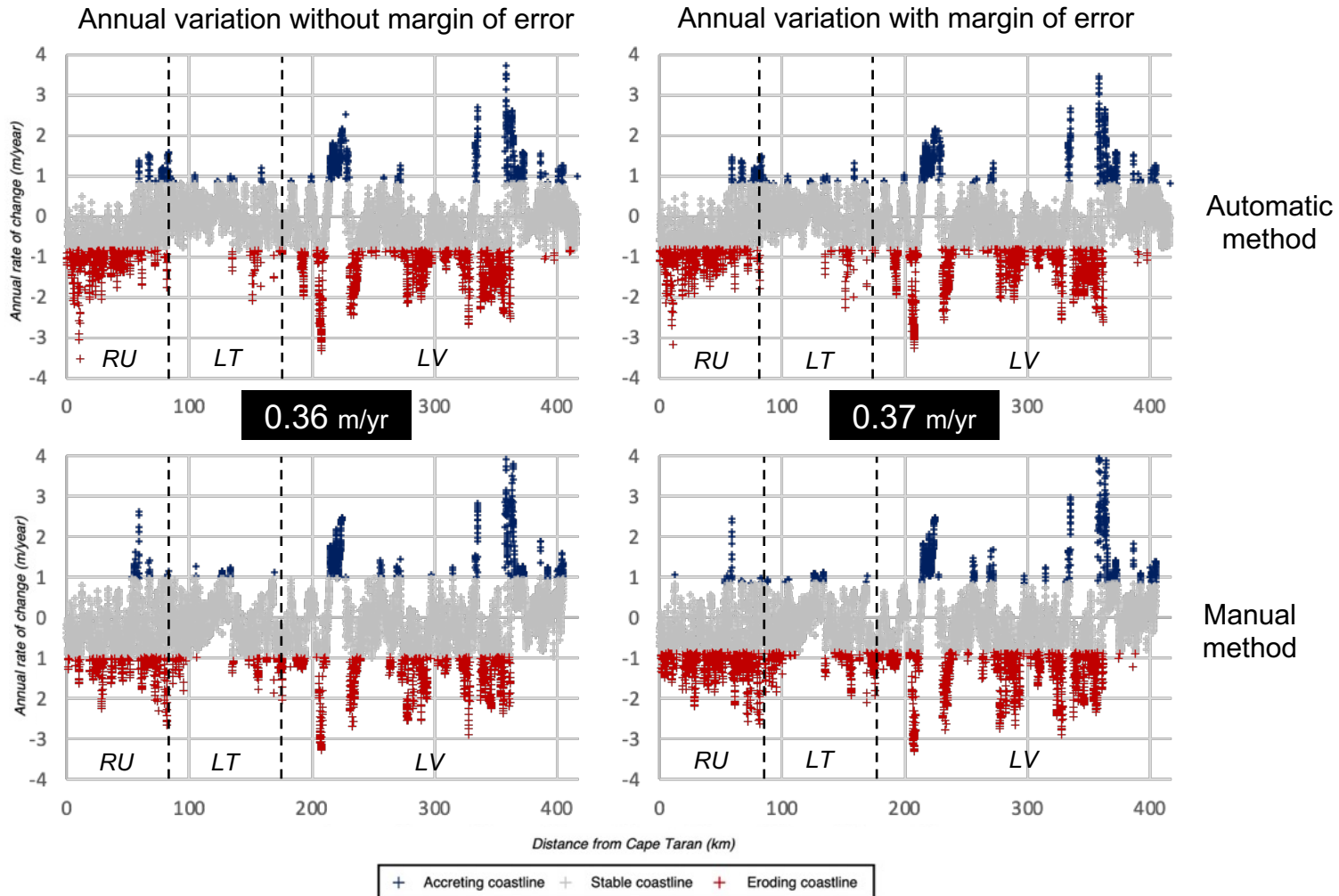

- Between 1988 and 2018, the south-eastern Baltic coast is characterised by overall stability.
- A manual method more sensitive to margins of error.
- 30% of the coastline presents a significantly regular evolution trend in time and space, whatever the extraction method.
- Non-significant differences between the two coastline extraction methods on both calculations with/without weighting.

## An intra-period evolution characterised by a great stability of the coastline

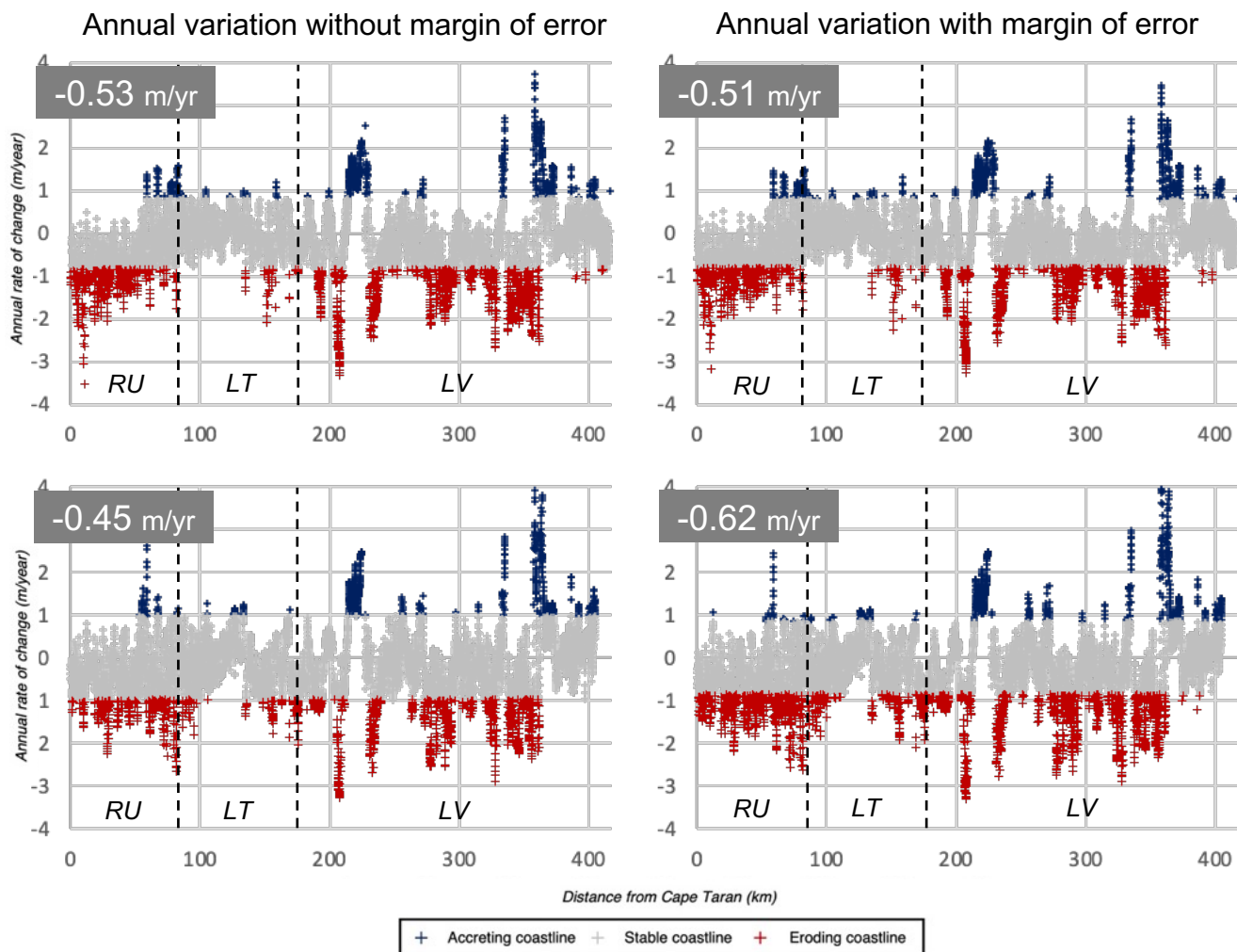

Automatic method

Manual method

- Between 1988 and 2018, the south-eastern Baltic coast is characterised by overall stability.
- A manual method more sensitive to margins of error.
- 30% of the coastline presents a significantly regular evolution trend in time and space, whatever the extraction method.
- Non-significant differences between the two coastline extraction methods on both calculations with/without weighting.
- 1/3 of Russian's coastline is in significant retreat.

## An intra-period evolution characterised by a great stability of the coastline

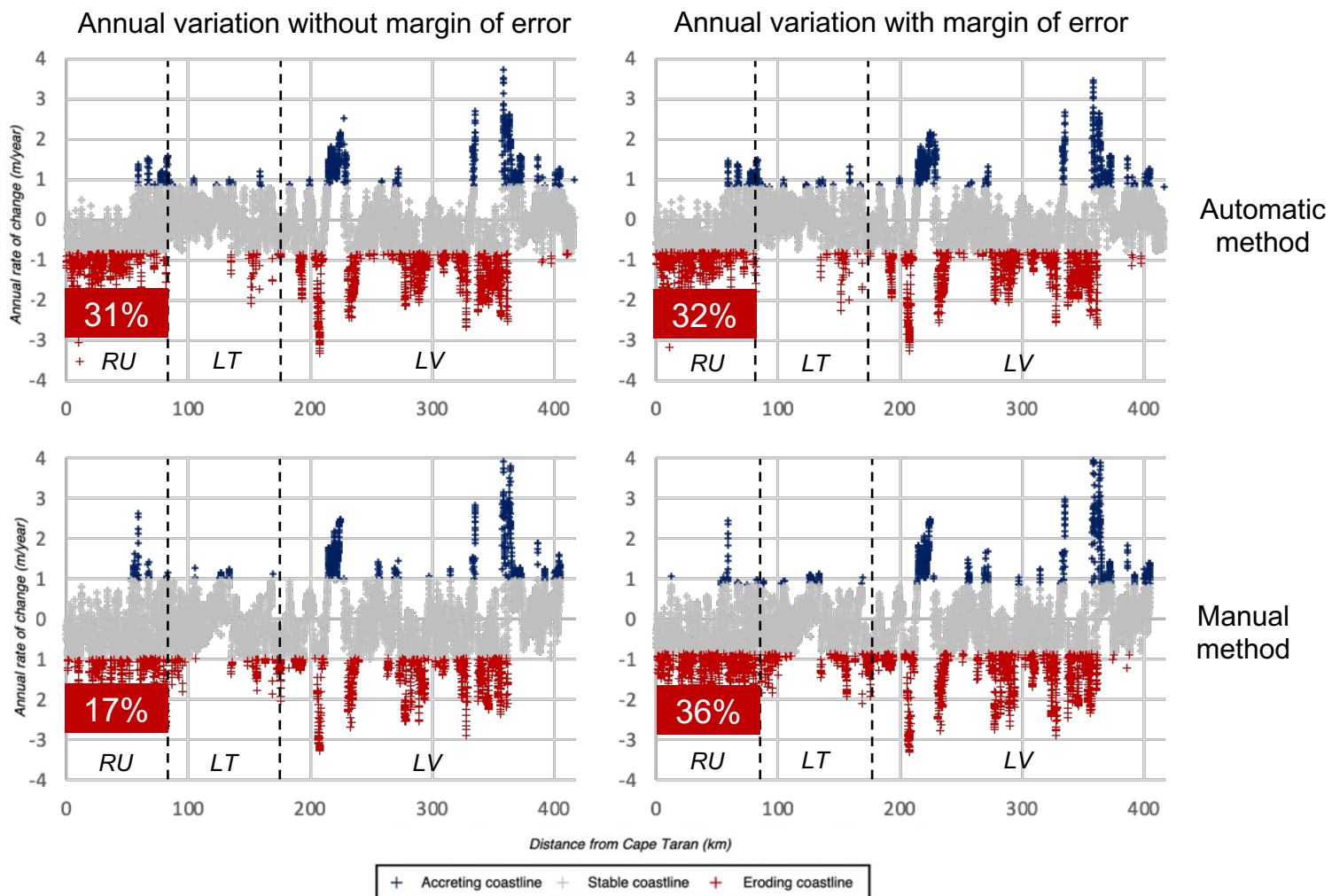

- Between 1988 and 2018, the south-eastern Baltic coast is characterised by overall stability.
- A manual method more sensitive to margins of error.
- 30% of the coastline presents a significantly regular evolution trend in time and space, whatever the extraction method.
- Non-significant differences between the two coastline extraction methods on both calculations with/without weighting.
- 1/3 of Russian's coastline is in significant retreat.



## An intra-period evolution characterised by a great stability of the coastline

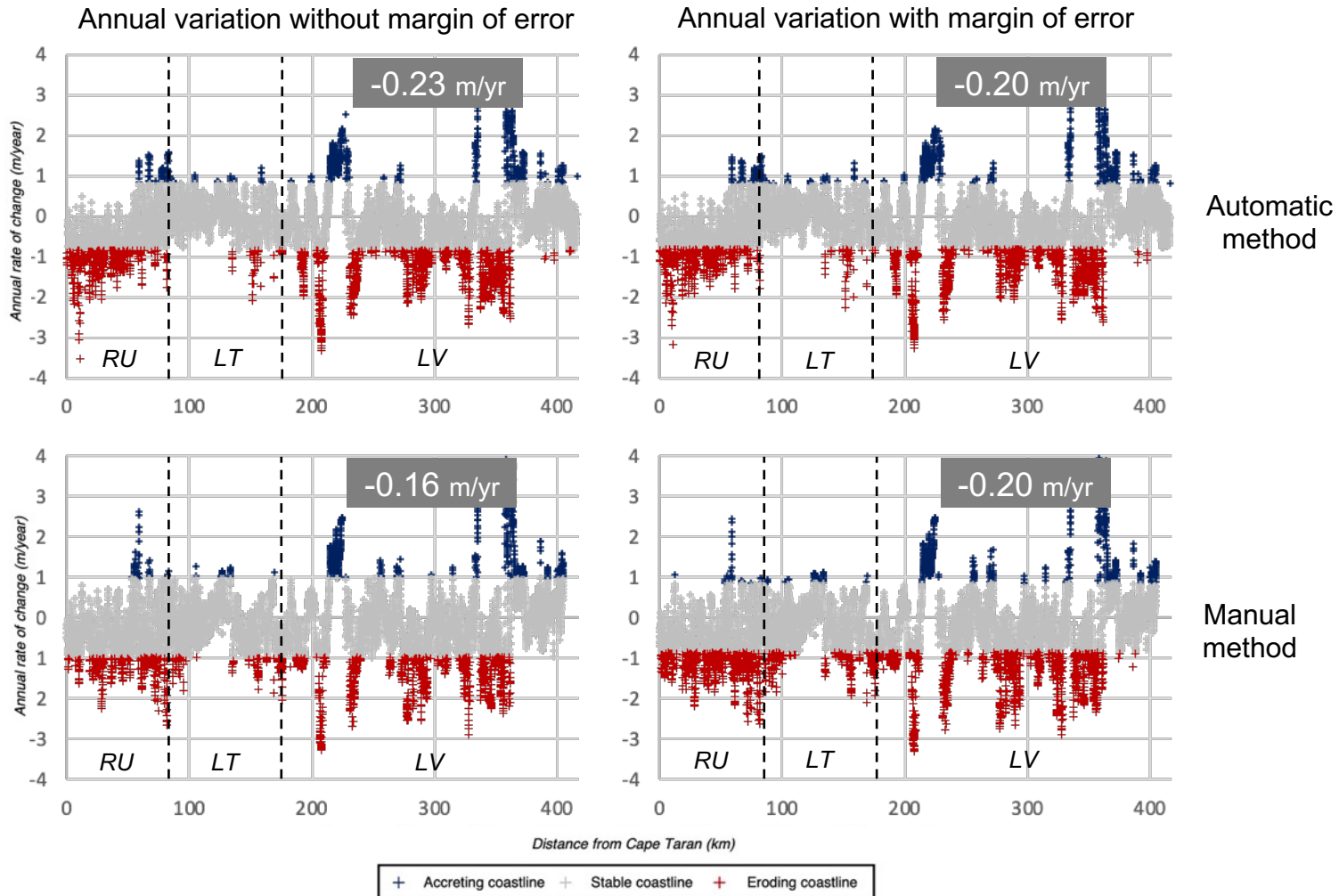

- Between 1988 and 2018, the south-eastern Baltic coast is characterised by overall stability.
- A manual method more sensitive to margins of error.
- 30% of the coastline presents a significantly regular evolution trend in time and space, whatever the extraction method.
- Non-significant differences between the two coastline extraction methods on both calculations with/without weighting.
- 1/3 of Russian's coastline is in significant retreat.
- More dispersed coastal variation values in Latvia.

## An intra-period evolution characterised by a great stability of the coastline

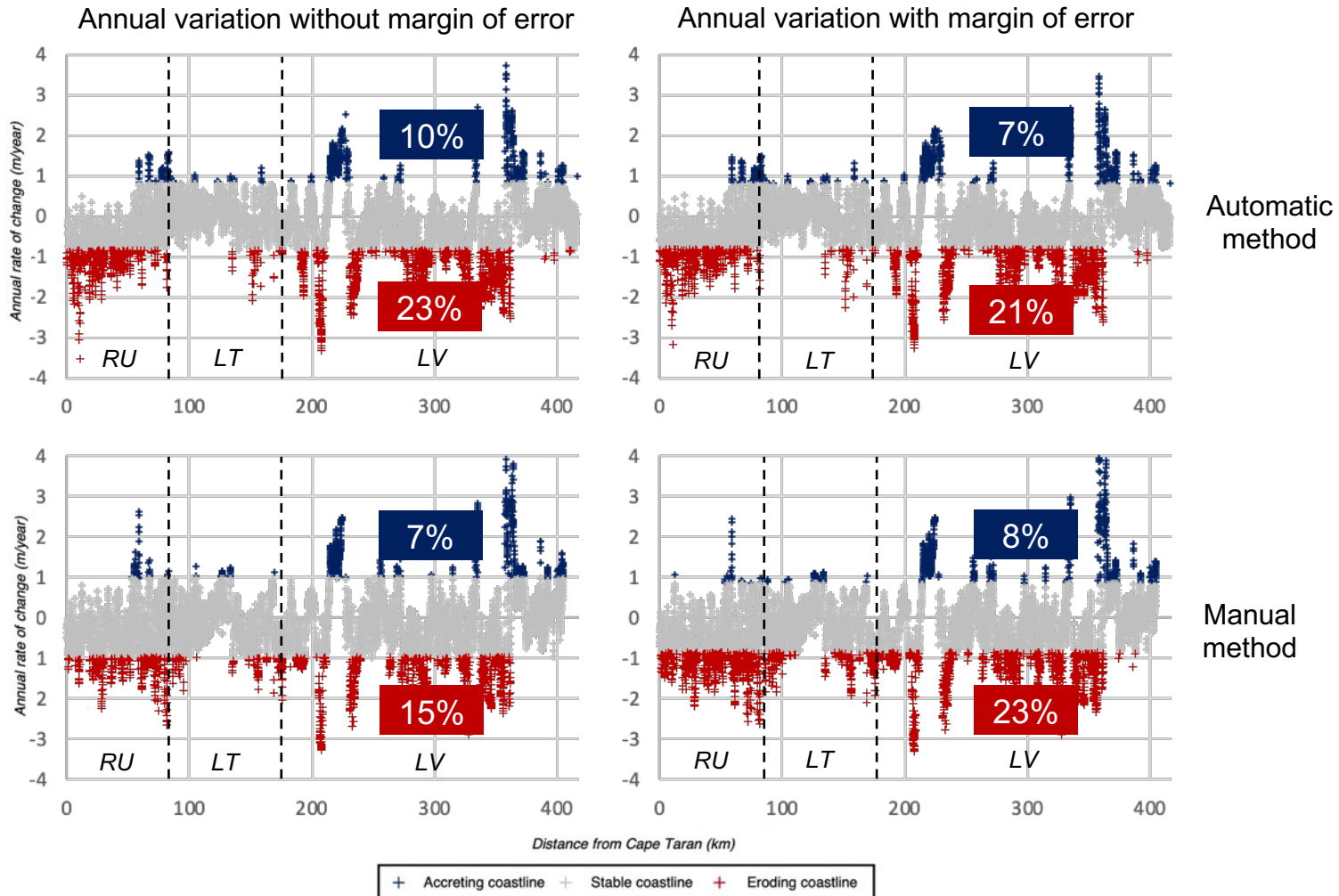

- Between 1988 and 2018, the south-eastern Baltic coast is characterised by overall stability.
- A manual method more sensitive to margins of error.
- 30% of the coastline presents a significantly regular evolution trend in time and space, whatever the extraction method.
- Non-significant differences between the two coastline extraction methods on both calculations with/without weighting.
- 1/3 of Russian's coastline is in significant retreat.
- More dispersed coastal variation values in Latvia.

## An intra-period evolution characterised by a great stability of the coastline

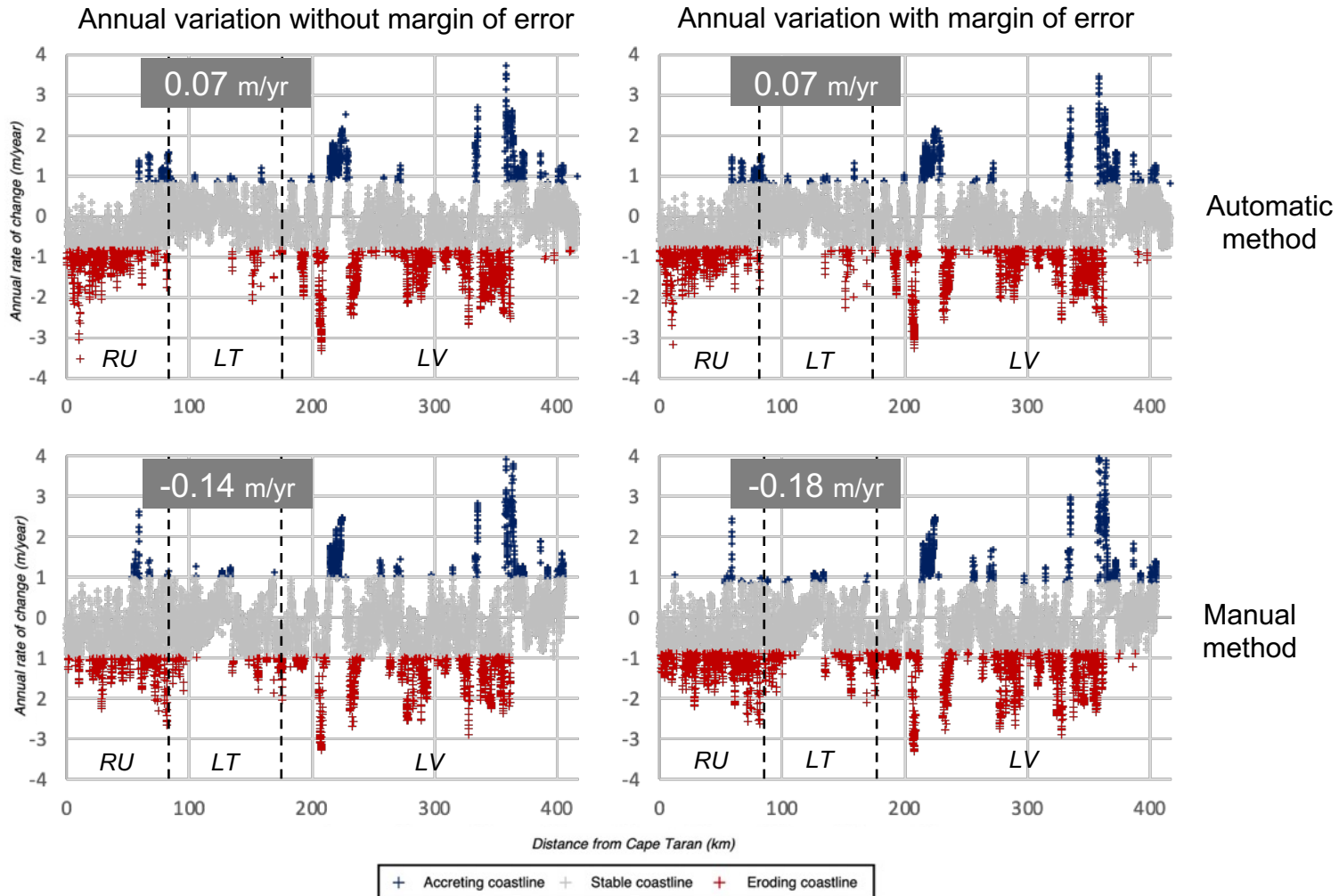

- Between 1988 and 2018, the south-eastern Baltic coast is characterised by overall stability.
- A manual method more sensitive to margins of error.
- 30% of the coastline presents a significantly regular evolution trend in time and space, whatever the extraction method.
- Non-significant differences between the two coastline extraction methods on both calculations with/without weighting.
- 1/3 of Russian's coastline is in significant retreat.
- More dispersed coastal variation values in Latvia.
- In Lithuania, a large part of the coastline is considered "stable".

## An intra-period evolution characterised by a great stability of the coastline

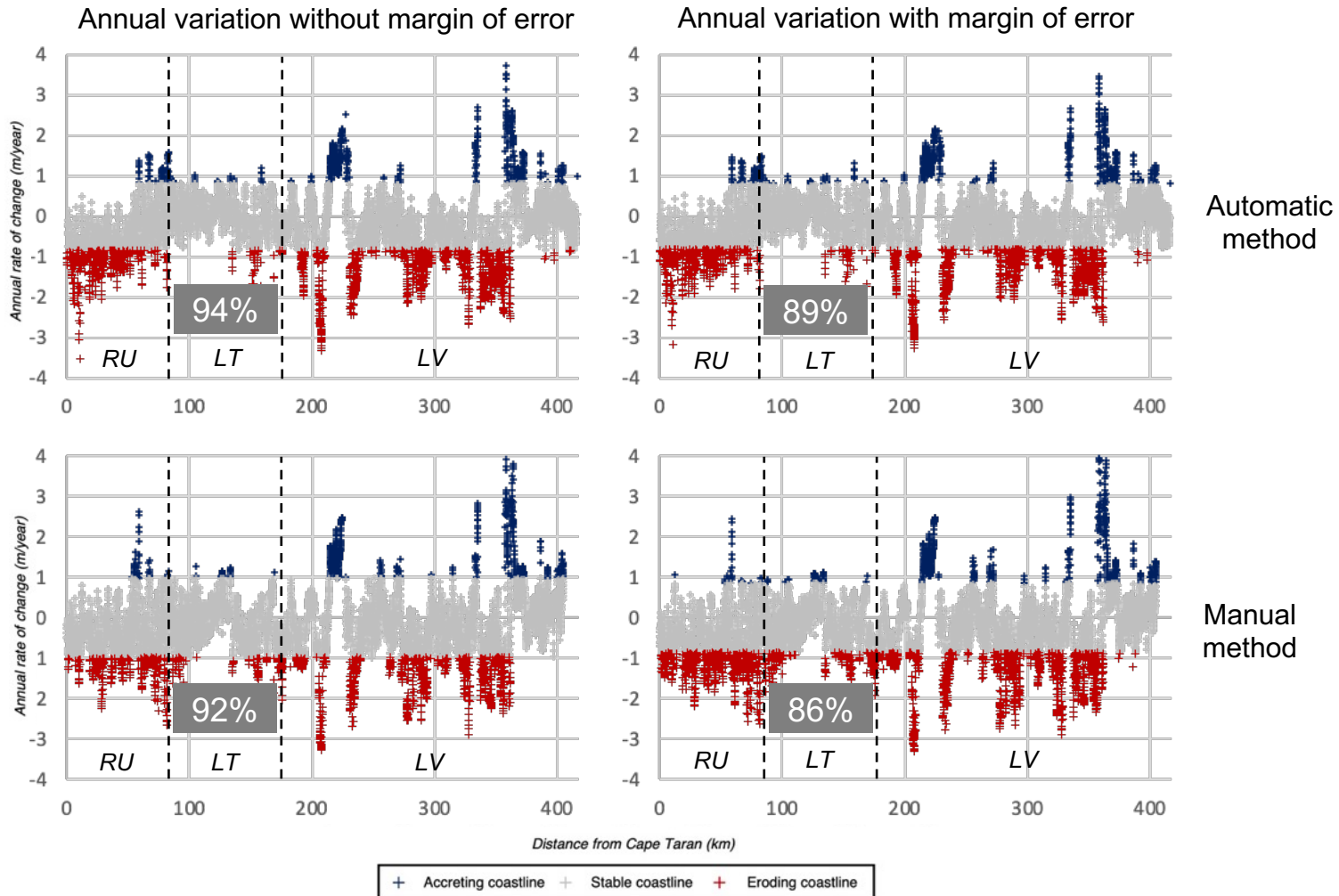

- Between 1988 and 2018, the south-eastern Baltic coast is characterised by overall stability.
- A manual method more sensitive to margins of error.
- 30% of the coastline presents a significantly regular evolution trend in time and space, whatever the extraction method.
- Non-significant differences between the two coastline extraction methods on both calculations with/without weighting.
- 1/3 of Russian's coastline is in significant retreat.
- More dispersed coastal variation values in Latvia.
- In Lithuania, a large part of the coastline is considered "stable".

# An inter-period evolution with a regular alternation between accretion and erosion zones disturbed over time

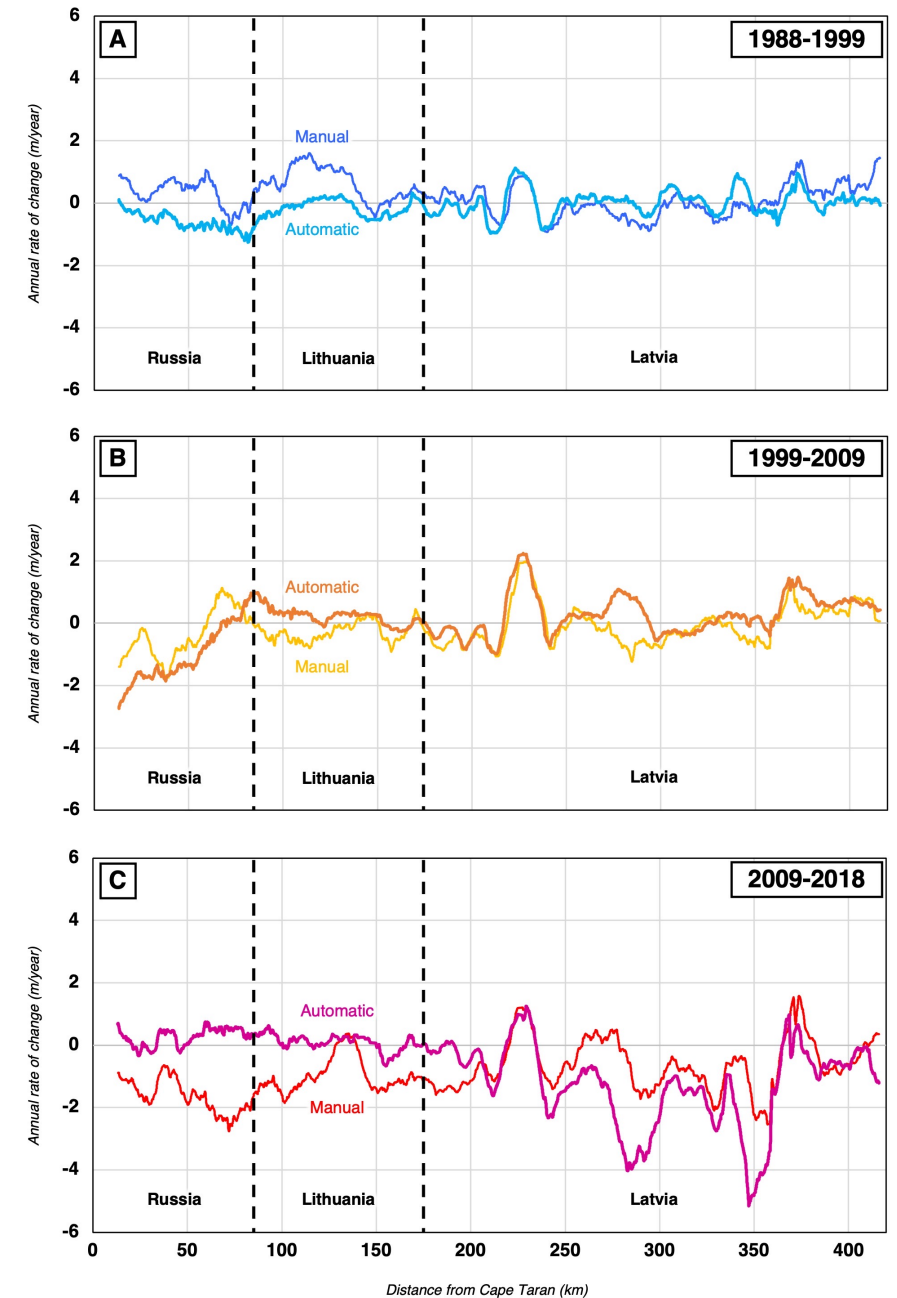

## An inter-period evolution with a regular alternation between accretion and erosion zones disturbed over time

- A trend of coastline retreat over time for both methods but no "significant" erosion.

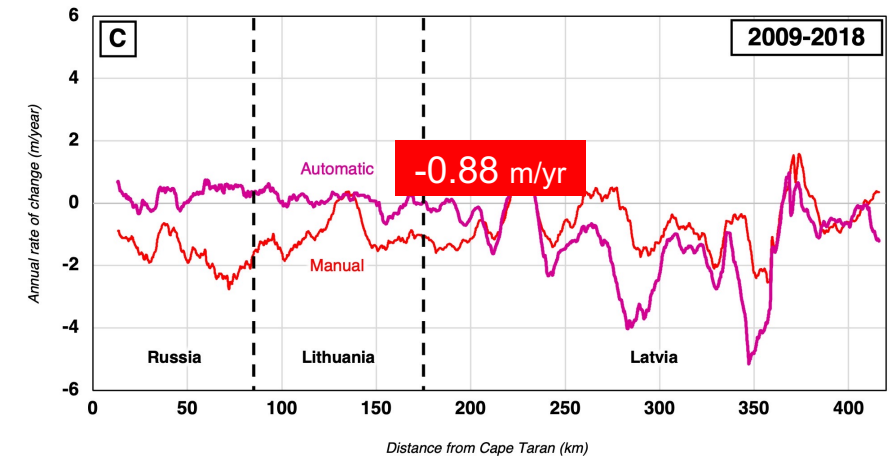
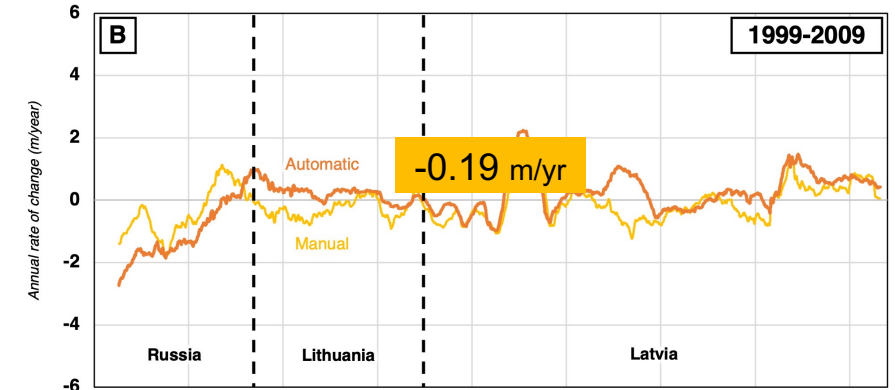
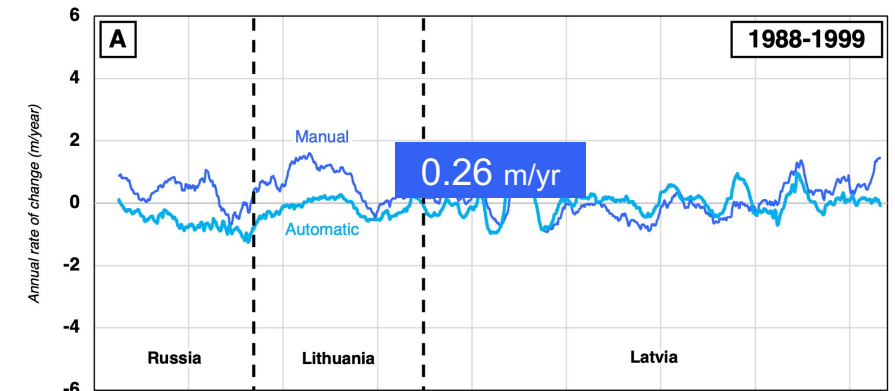

## An inter-period evolution with a regular alternation between accretion and erosion zones disturbed over time

- A trend of coastline retreat over time for both methods but no "significant" erosion.

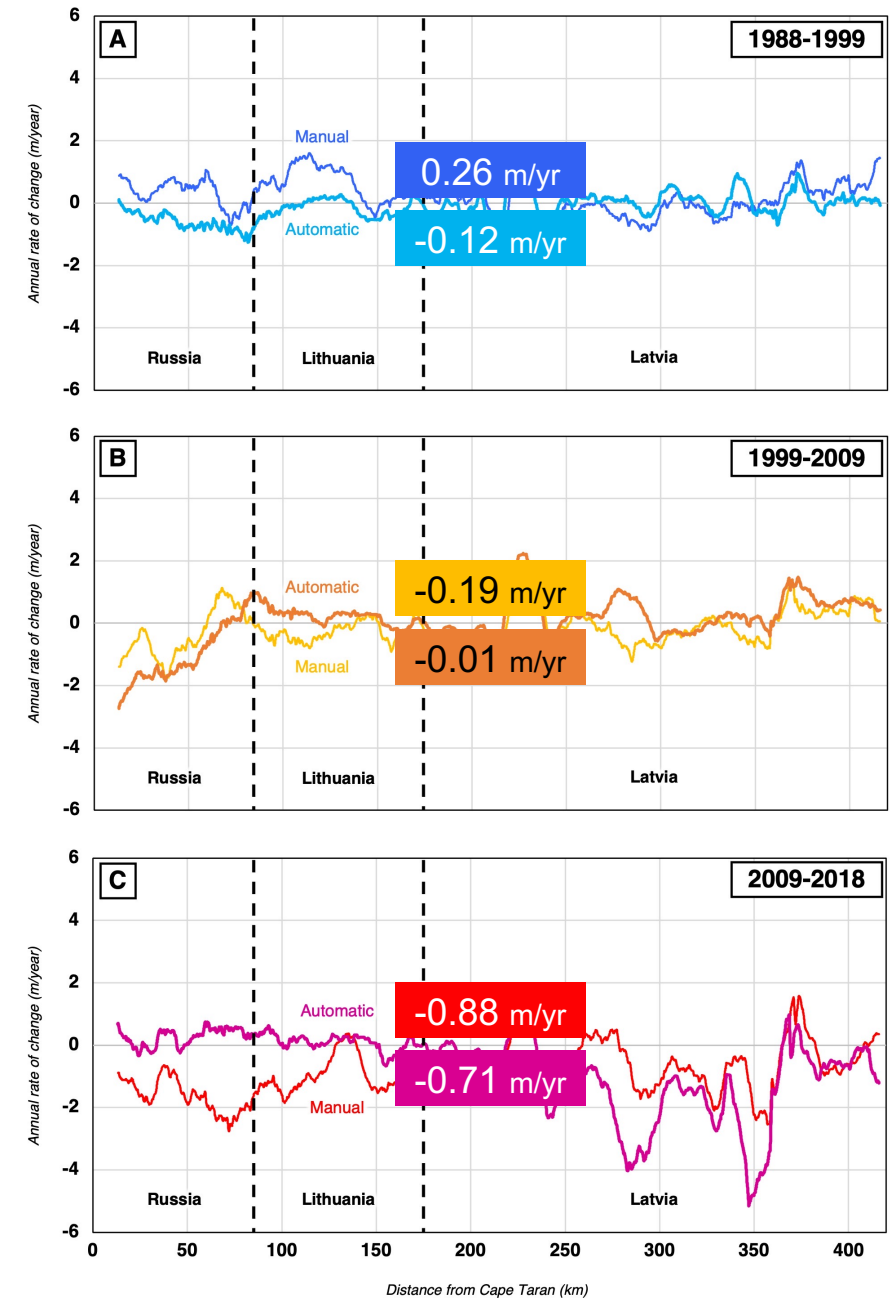

## An inter-period evolution with a regular alternation between accretion and erosion zones disturbed over time

- A trend of coastline retreat over time for both methods but no "significant" erosion.
- Some alternation of eroding and accreting areas for the period 1988-1999 for both methods.

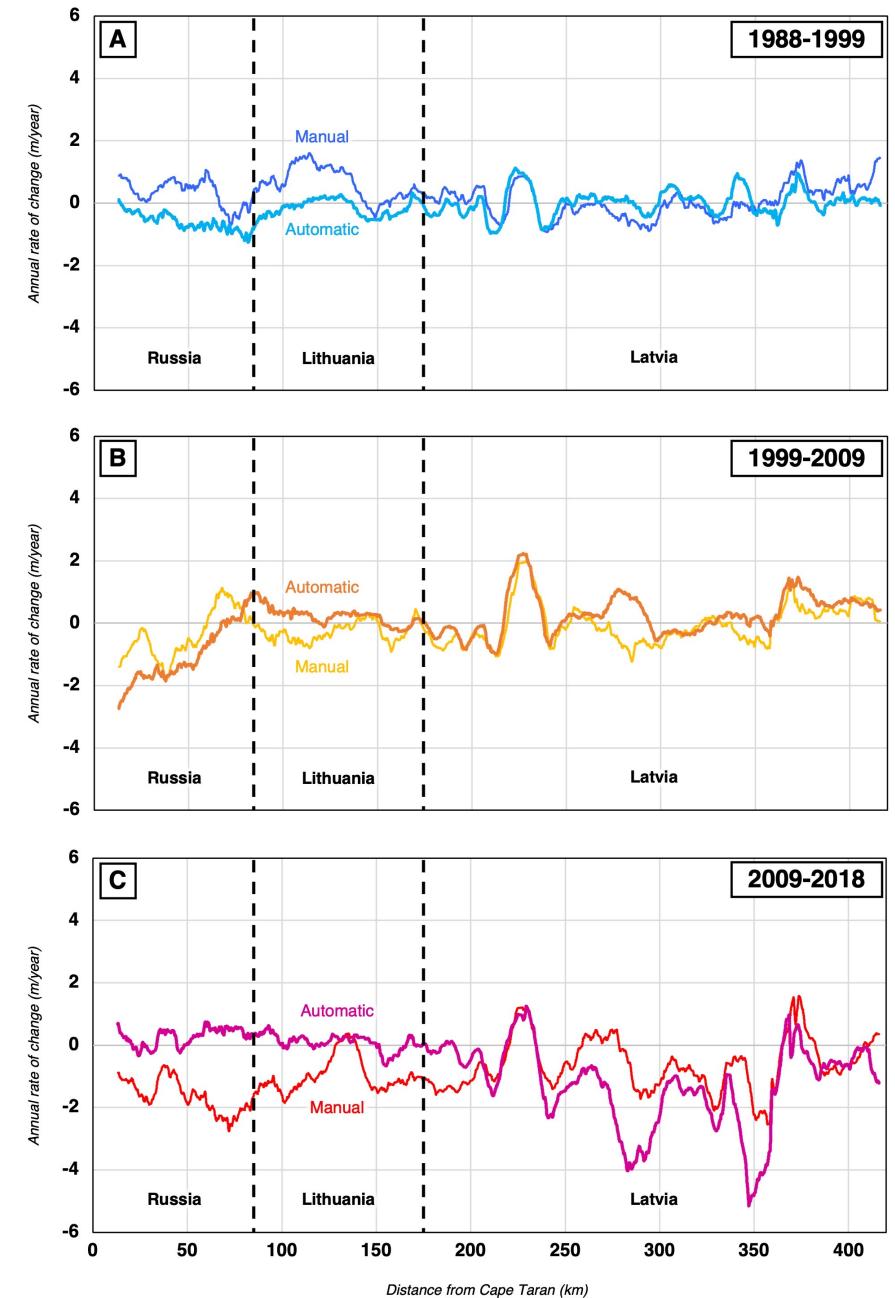



## An inter-period evolution with a regular alternation between accretion and erosion zones disturbed over time

- A trend of coastline retreat over time for both methods but no "significant" erosion.
- Some alternation of eroding and accreting areas for the period 1988-1999 for both methods.
- Increasing erosion for the manual method with significant variations in Russia and Lithuania.

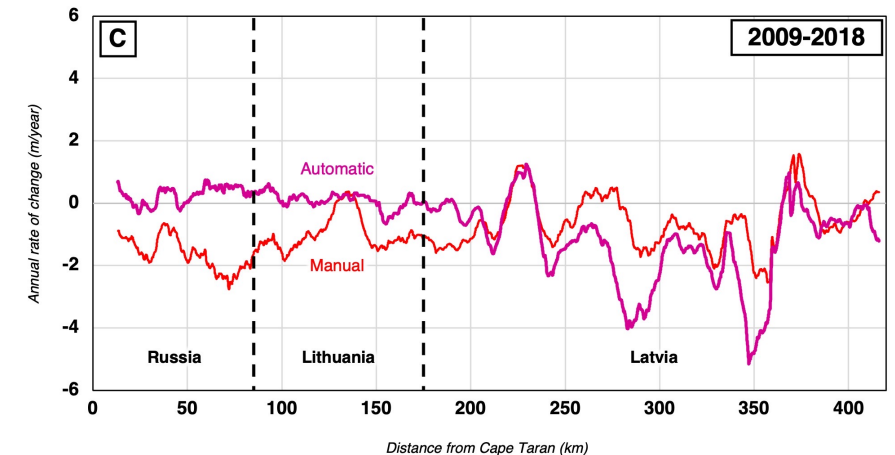
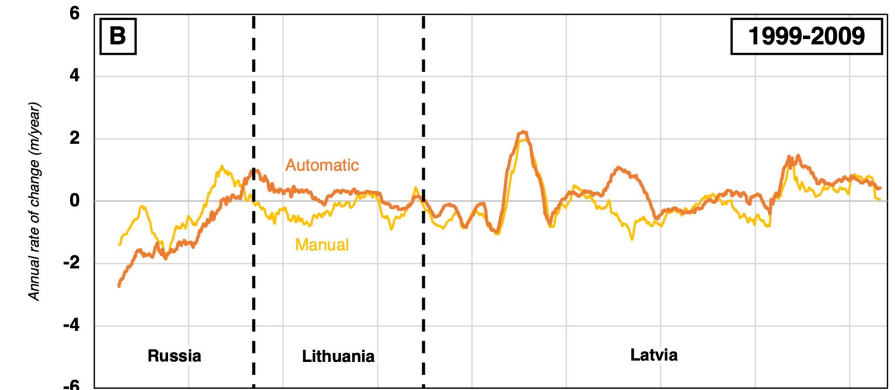
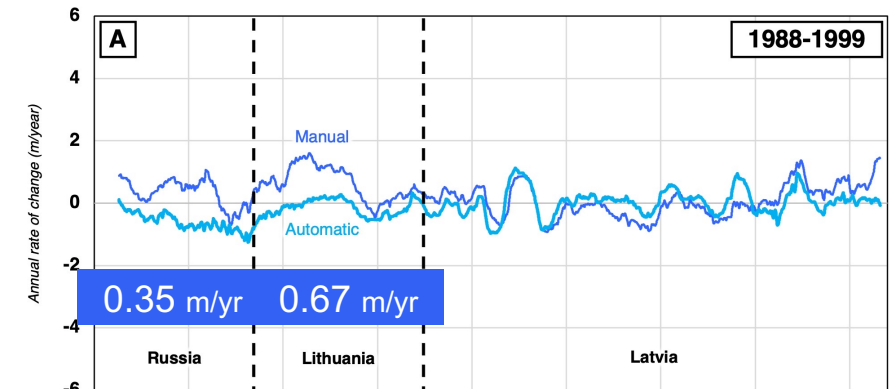

## An inter-period evolution with a regular alternation between accretion and erosion zones disturbed over time

- A trend of coastline retreat over time for both methods but no "significant" erosion.
- Some alternation of eroding and accreting areas for the period 1988-1999 for both methods.
- Increasing erosion for the manual method with significant variations in Russia and Lithuania.

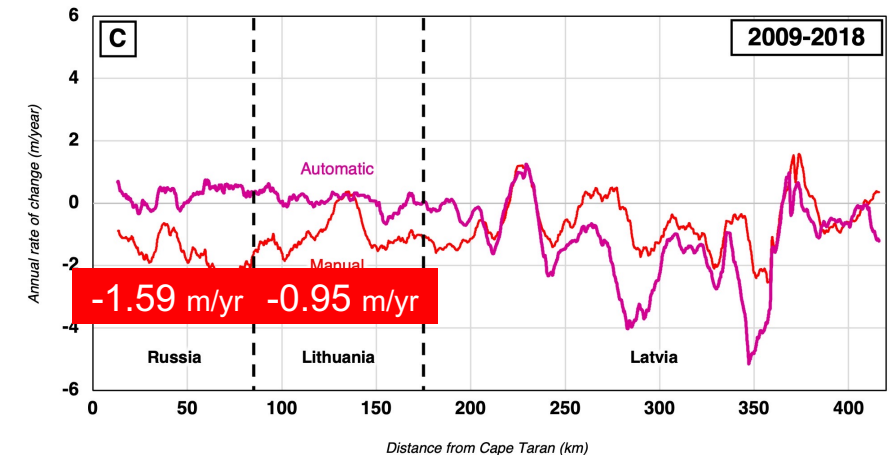
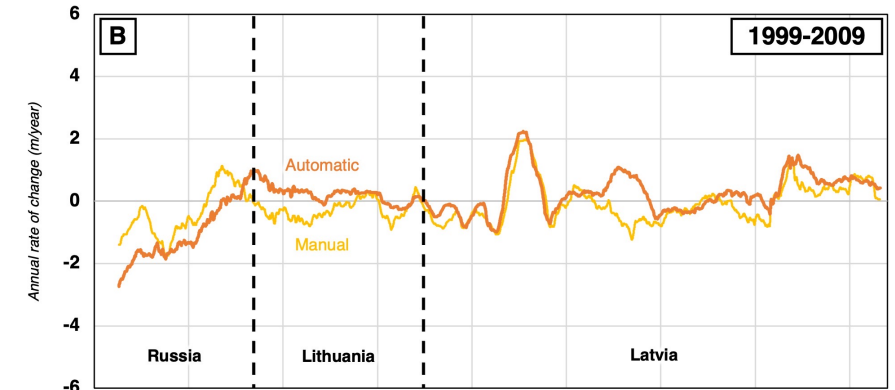
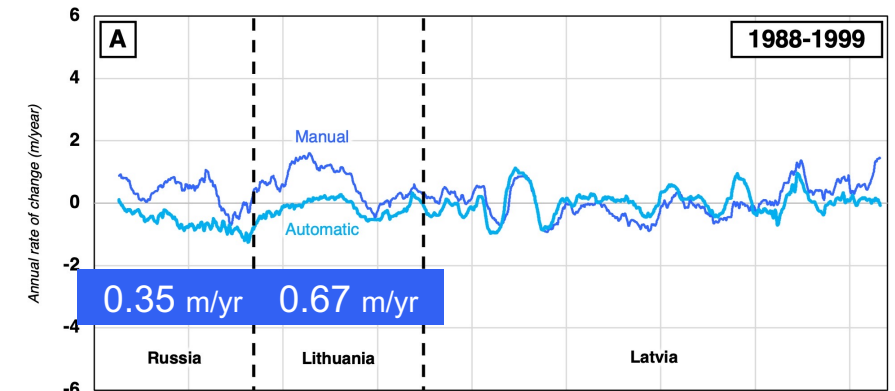

## An inter-period evolution with a regular alternation between accretion and erosion zones disturbed over time

- A trend of coastline retreat over time for both methods but no "significant" erosion.
- Some alternation of eroding and accreting areas for the period 1988-1999 for both methods.
- Increasing erosion for the manual method with significant variations in Russia and Lithuania.

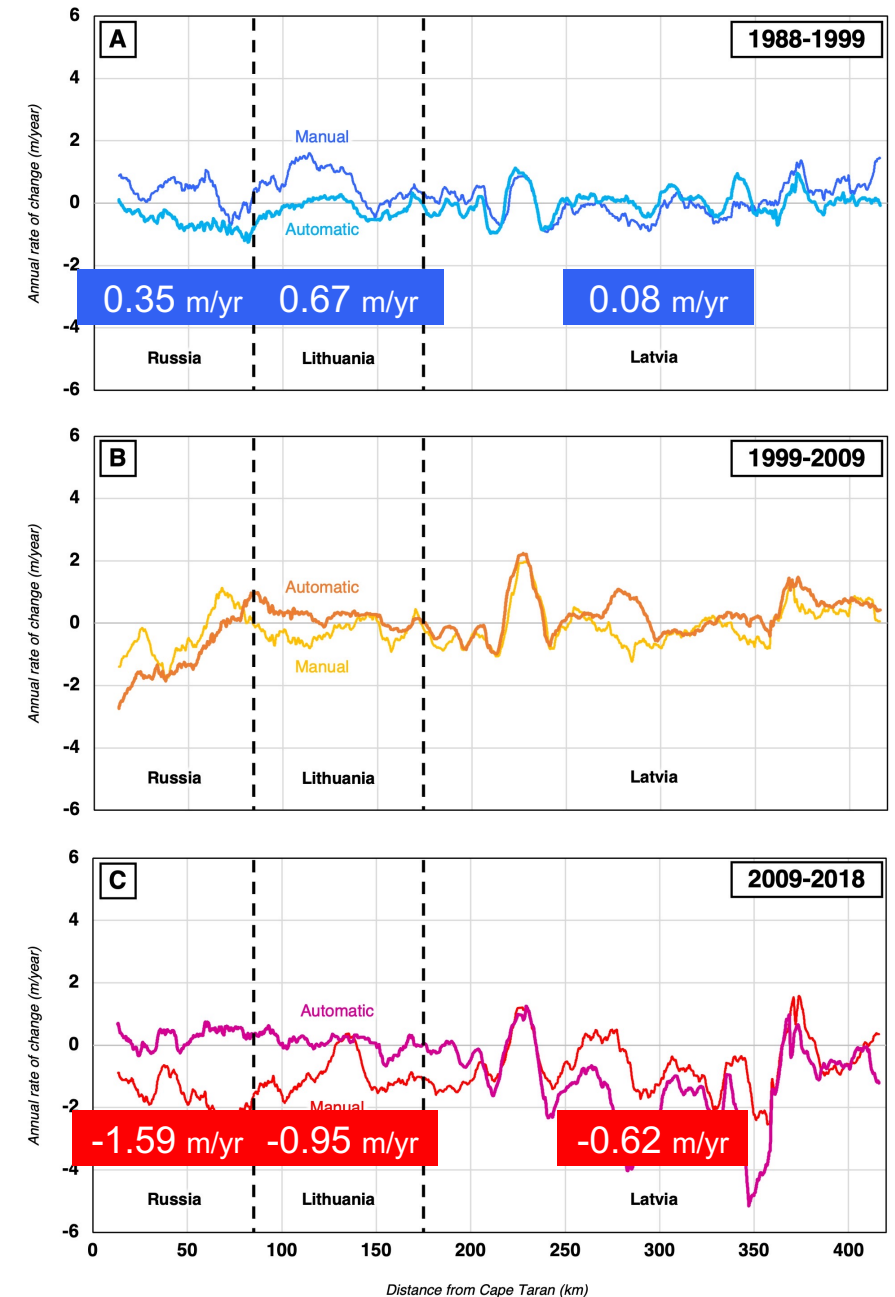

## An inter-period evolution with a regular alternation between accretion and erosion zones disturbed over time

- A trend of coastline retreat over time for both methods but no "significant" erosion.
- Some alternation of eroding and accreting areas for the period 1988-1999 for both methods.
- Increasing erosion for the manual method with significant variations in Russia and Lithuania.
- A change in the spatial dynamics of coastal evolution for the automatic method.

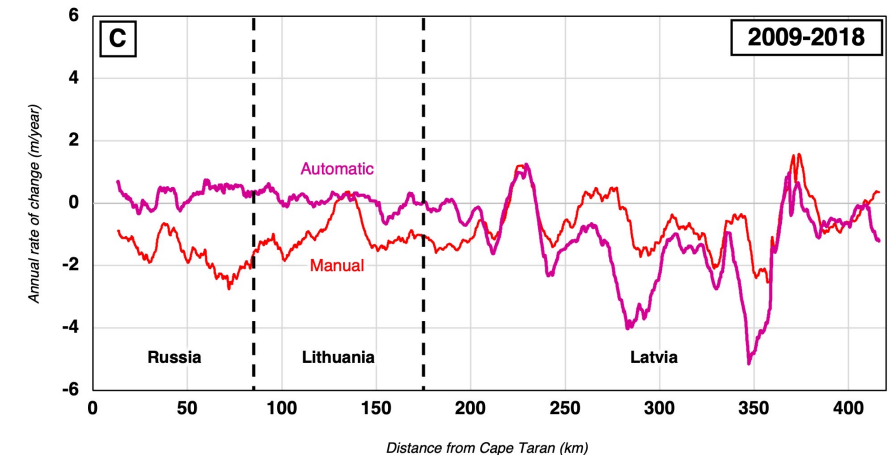
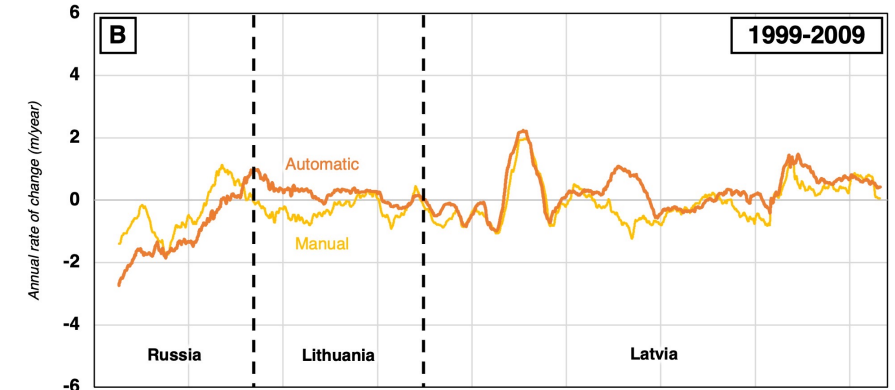
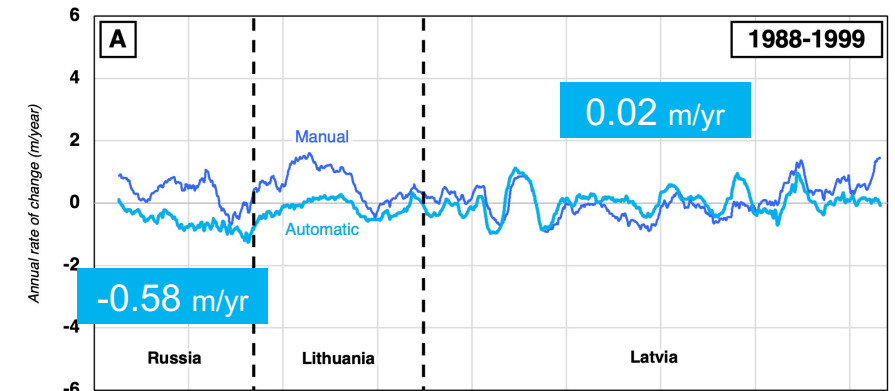

## An inter-period evolution with a regular alternation between accretion and erosion zones disturbed over time

- A trend of coastline retreat over time for both methods but no "significant" erosion.
- Some alternation of eroding and accreting areas for the period 1988-1999 for both methods.
- Increasing erosion for the manual method with significant variations in Russia and Lithuania.
- A change in the spatial dynamics of coastal evolution for the automatic method.

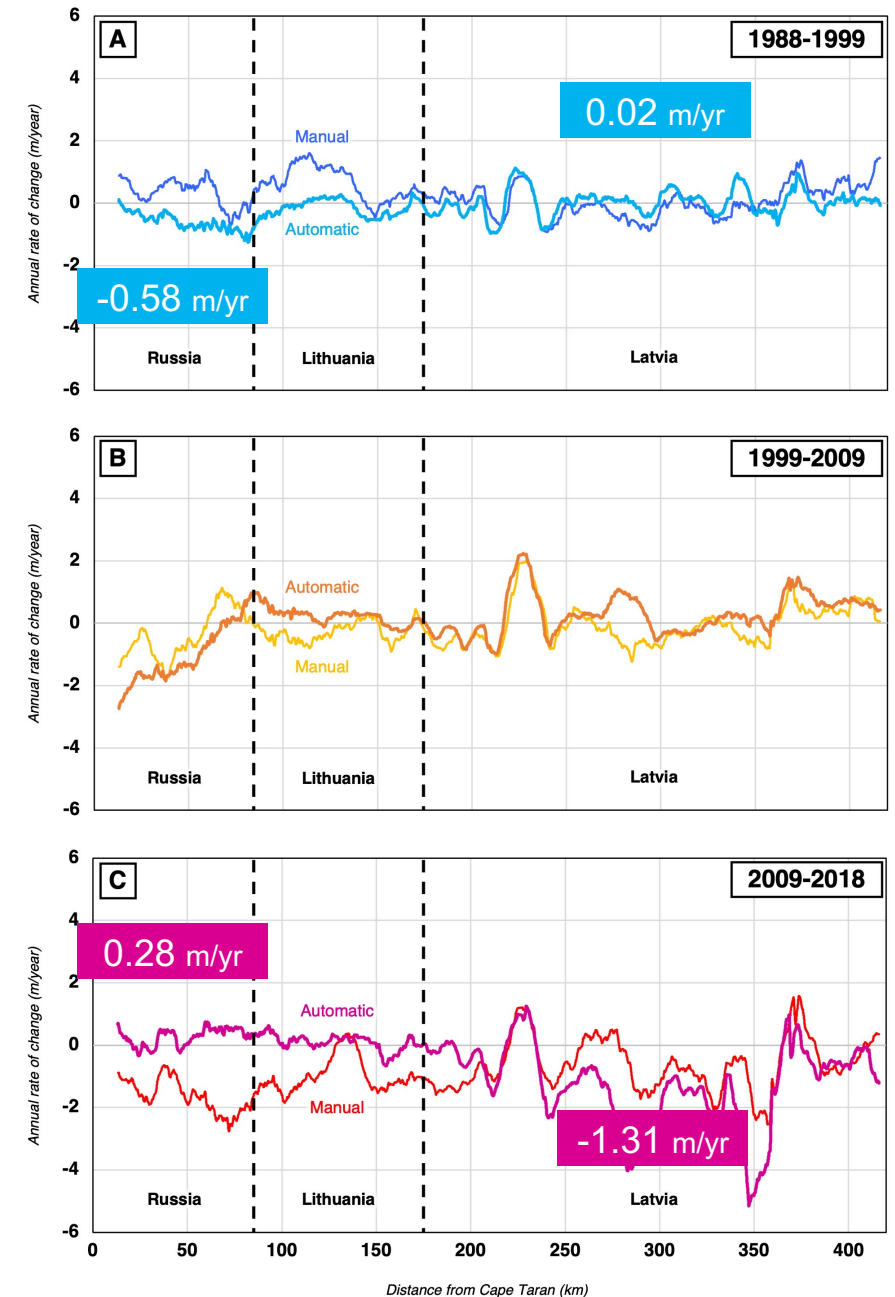

## An inter-period evolution with a regular alternation between accretion and erosion zones disturbed over time

- A trend of coastline retreat over time for both methods but no "significant" erosion.
- Some alternation of eroding and accreting areas for the period 1988-1999 for both methods.
- Increasing erosion for the manual method with significant variations in Russia and Lithuania.
- A change in the spatial dynamics of coastal evolution for the automatic method.

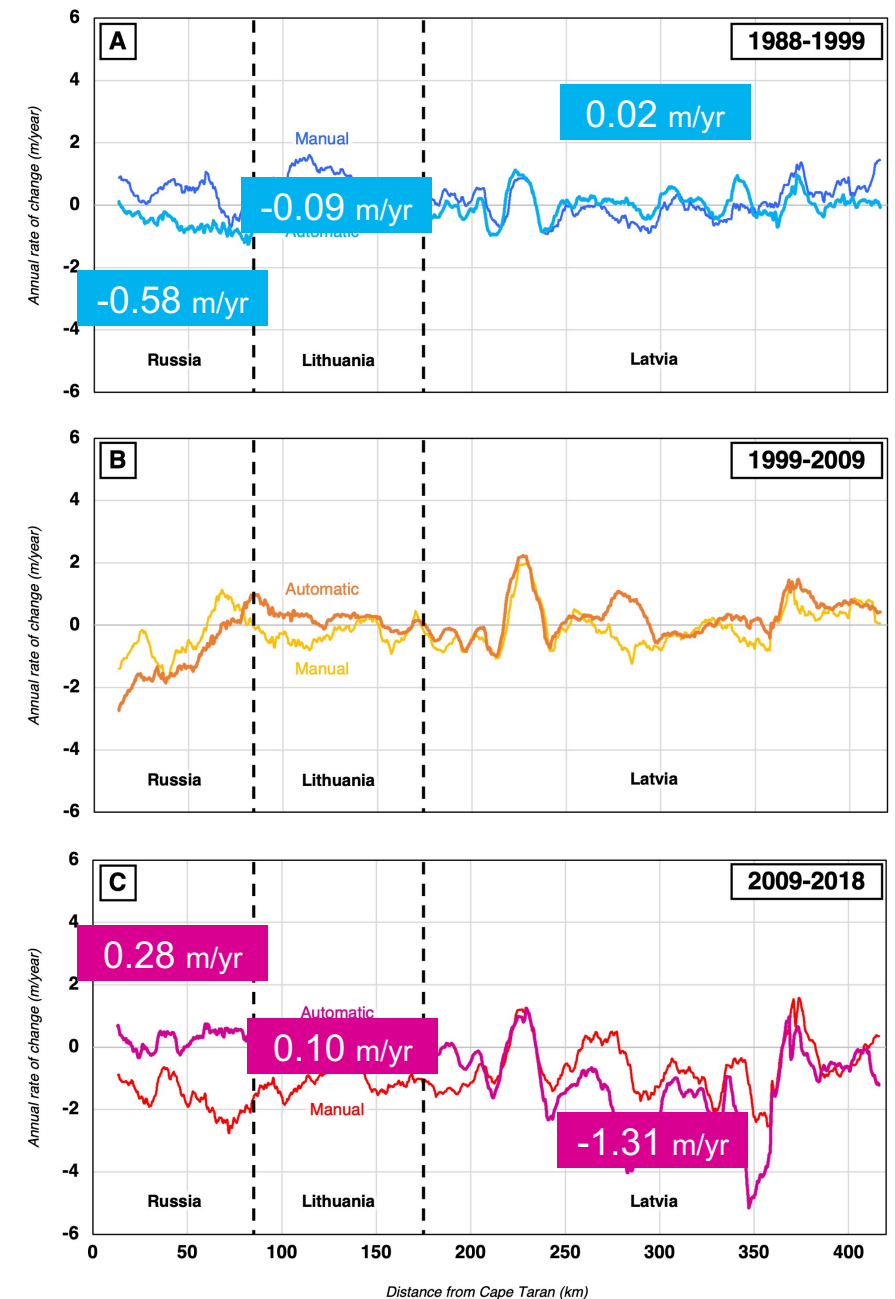

## An inter-period evolution with a regular alternation between accretion and erosion zones disturbed over time

- A trend of coastline retreat over time for both methods but no "significant" erosion.
- Some alternation of eroding and accreting areas for the period 1988-1999 for both methods.
- Increasing erosion for the manual method with significant variations in Russia and Lithuania.
- A change in the spatial dynamics of coastal evolution for the automatic method.

## Analysis of the spatial accuracy of the results

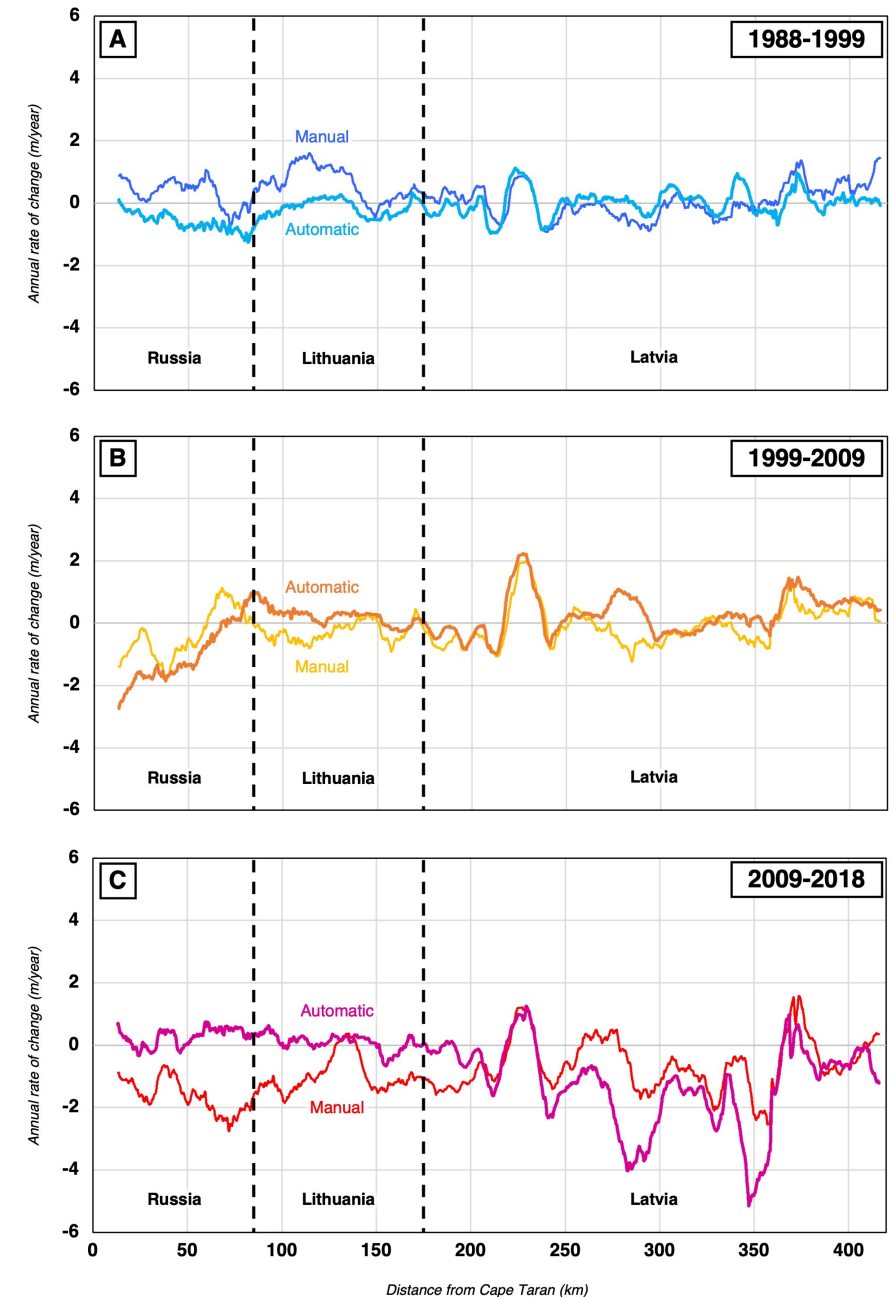

## An inter-period evolution with a regular alternation between accretion and erosion zones disturbed over time

- A trend of coastline retreat over time for both methods but no "significant" erosion.
- Some alternation of eroding and accreting areas for the period 1988-1999 for both methods.
- Increasing erosion for the manual method with significant variations in Russia and Lithuania.
- A change in the spatial dynamics of coastal evolution for the automatic method.

## Analysis of the spatial accuracy of the results

- 1988-1999: same evolution trends except for the Curonian Spit.

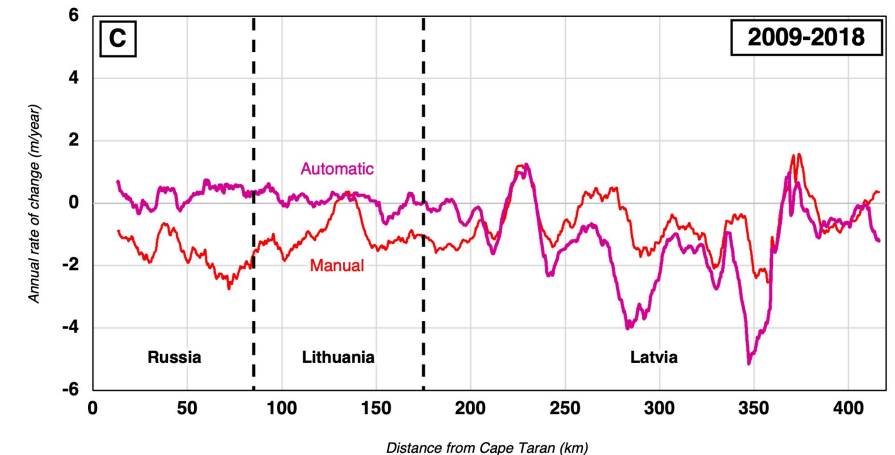
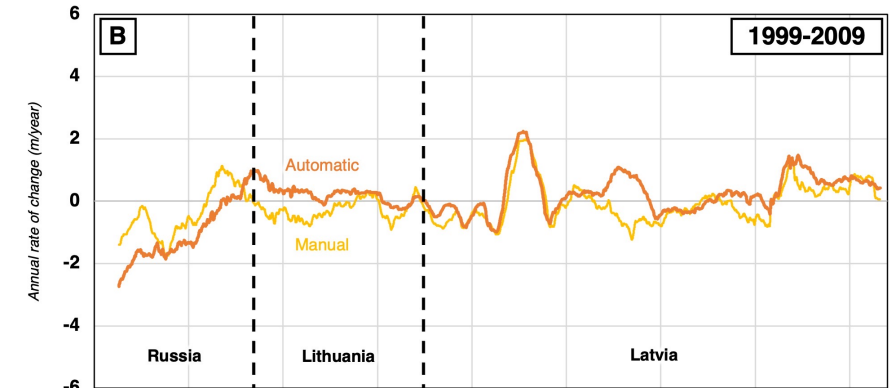
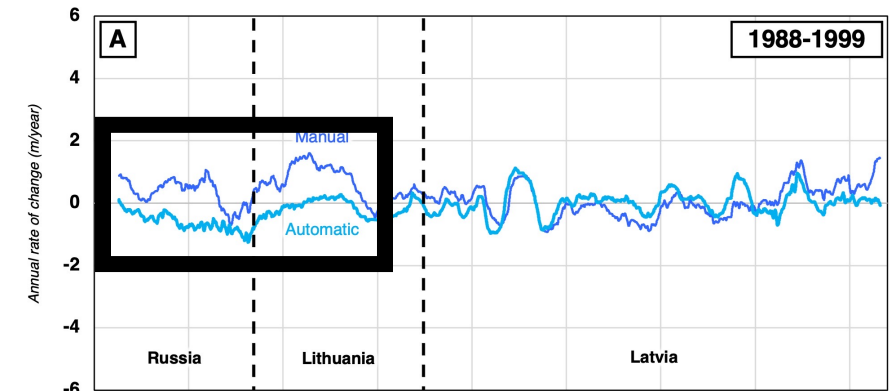



## An inter-period evolution with a regular alternation between accretion and erosion zones disturbed over time

- A trend of coastline retreat over time for both methods but no "significant" erosion.
- Some alternation of eroding and accreting areas for the period 1988-1999 for both methods.
- Increasing erosion for the manual method with significant variations in Russia and Lithuania.
- A change in the spatial dynamics of coastal evolution for the automatic method.

## Analysis of the spatial accuracy of the results

- 1988-1999: same evolution trends except for the Curonian Spit.
- 1999-2009: small differences between the annual variations with the exception of the Sambian and Curonian coasts and Pavilosta port region.

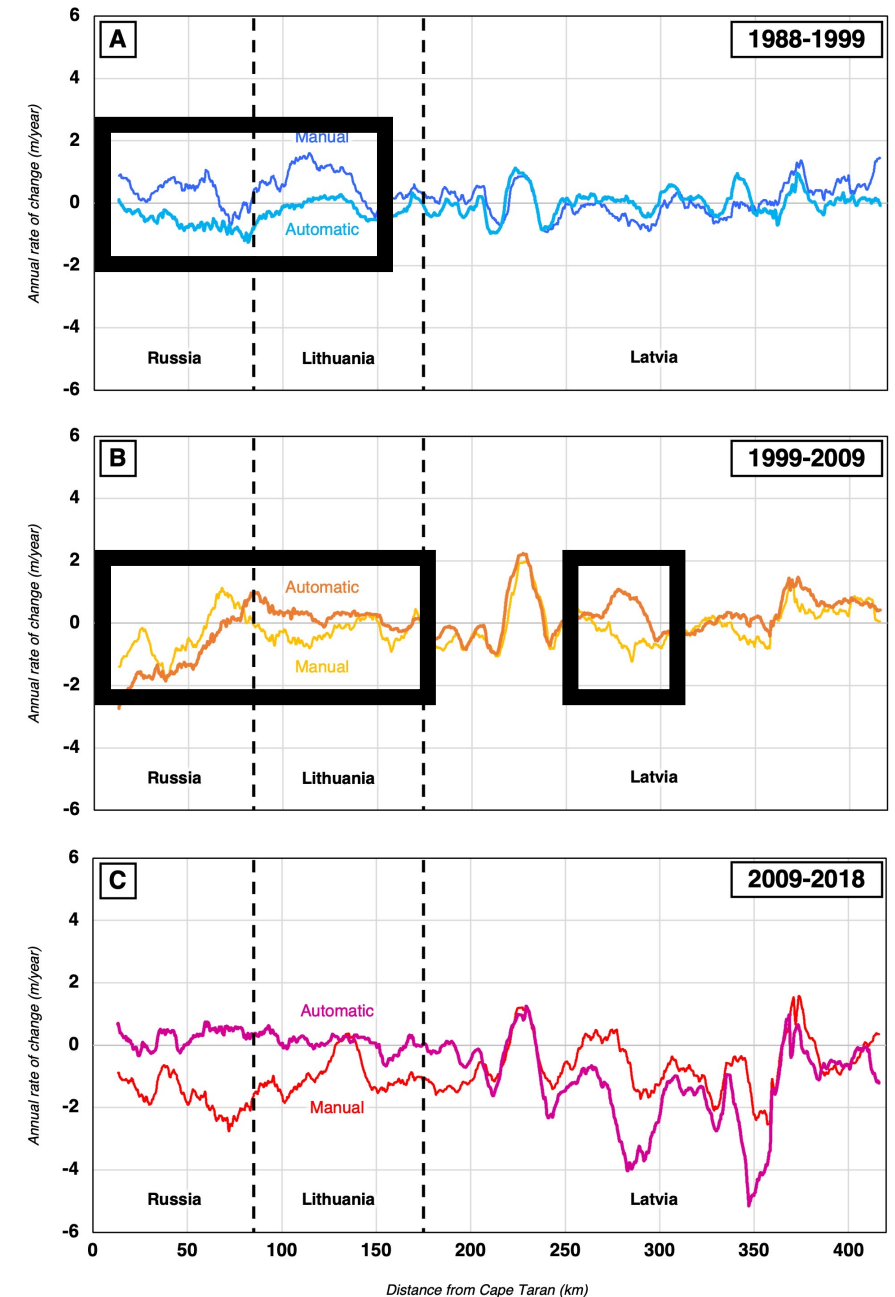

## An inter-period evolution with a regular alternation between accretion and erosion zones disturbed over time

- A trend of coastline retreat over time for both methods but no "significant" erosion.
- Some alternation of eroding and accreting areas for the period 1988-1999 for both methods.
- Increasing erosion for the manual method with significant variations in Russia and Lithuania.
- A change in the spatial dynamics of coastal evolution for the automatic method.

## Analysis of the spatial accuracy of the results

- 1988-1999: same evolution trends except for the Curonian Spit.
- 1999-2009: small differences between the annual variations with the exception of the Sambian and Curonian coasts and Pavilosta port region.
- 2009-2018: significant differences between the two methods.

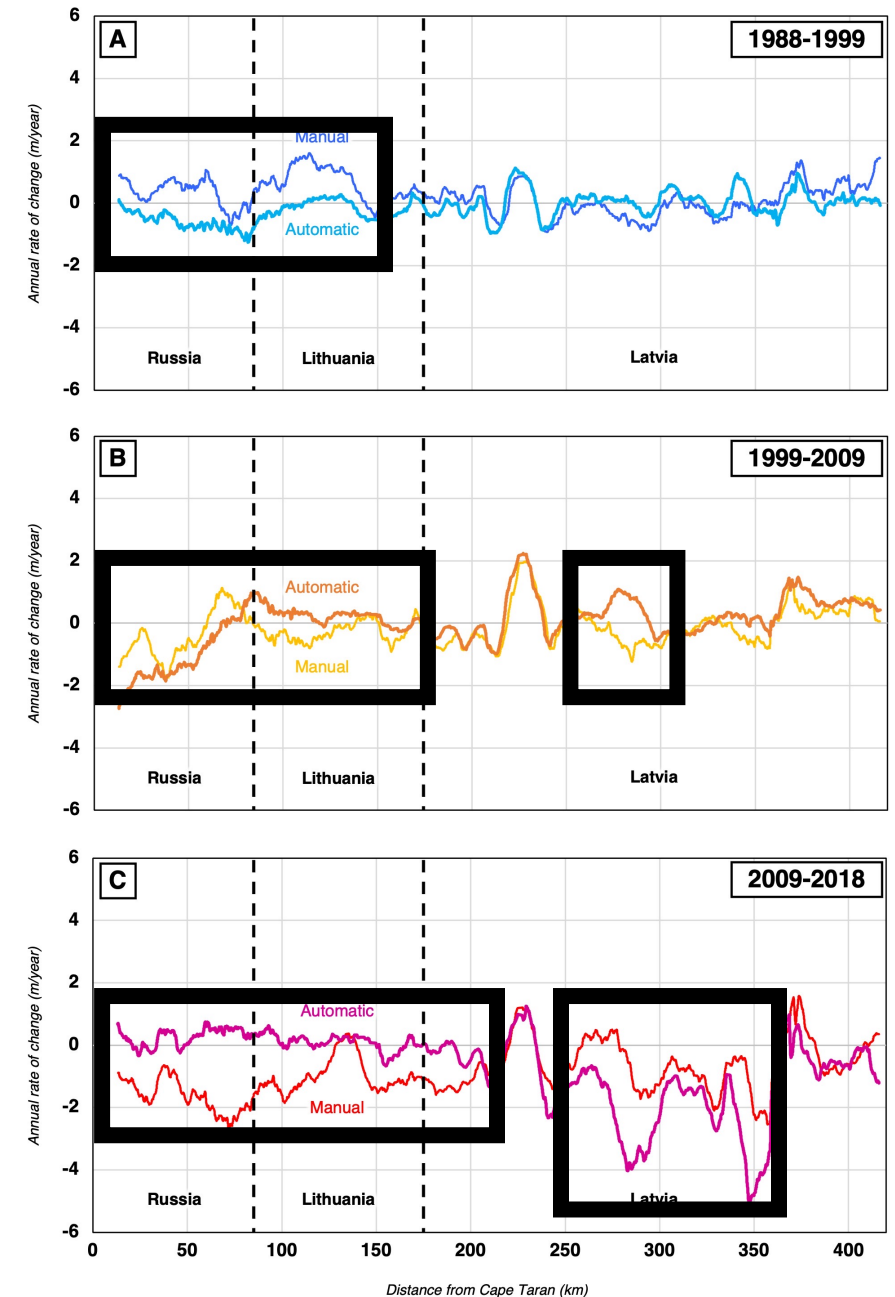

## An inter-period evolution with a regular alternation between accretion and erosion zones disturbed over time

- A trend of coastline retreat over time for both methods but no "significant" erosion.
- Some alternation of eroding and accreting areas for the period 1988-1999 for both methods.
- Increasing erosion for the manual method with significant variations in Russia and Lithuania.
- A change in the spatial dynamics of coastal evolution for the automatic method.

## Analysis of the spatial accuracy of the results

- 1988-1999: same evolution trends except for the Curonian Spit.
- 1999-2009: small differences between the annual variations with the exception of the Sambian and Curonian coasts and Pavilosta port region.
- 2009-2018: significant differences between the two methods.
- Cyclical dynamics in port areas whatever the period and the method.

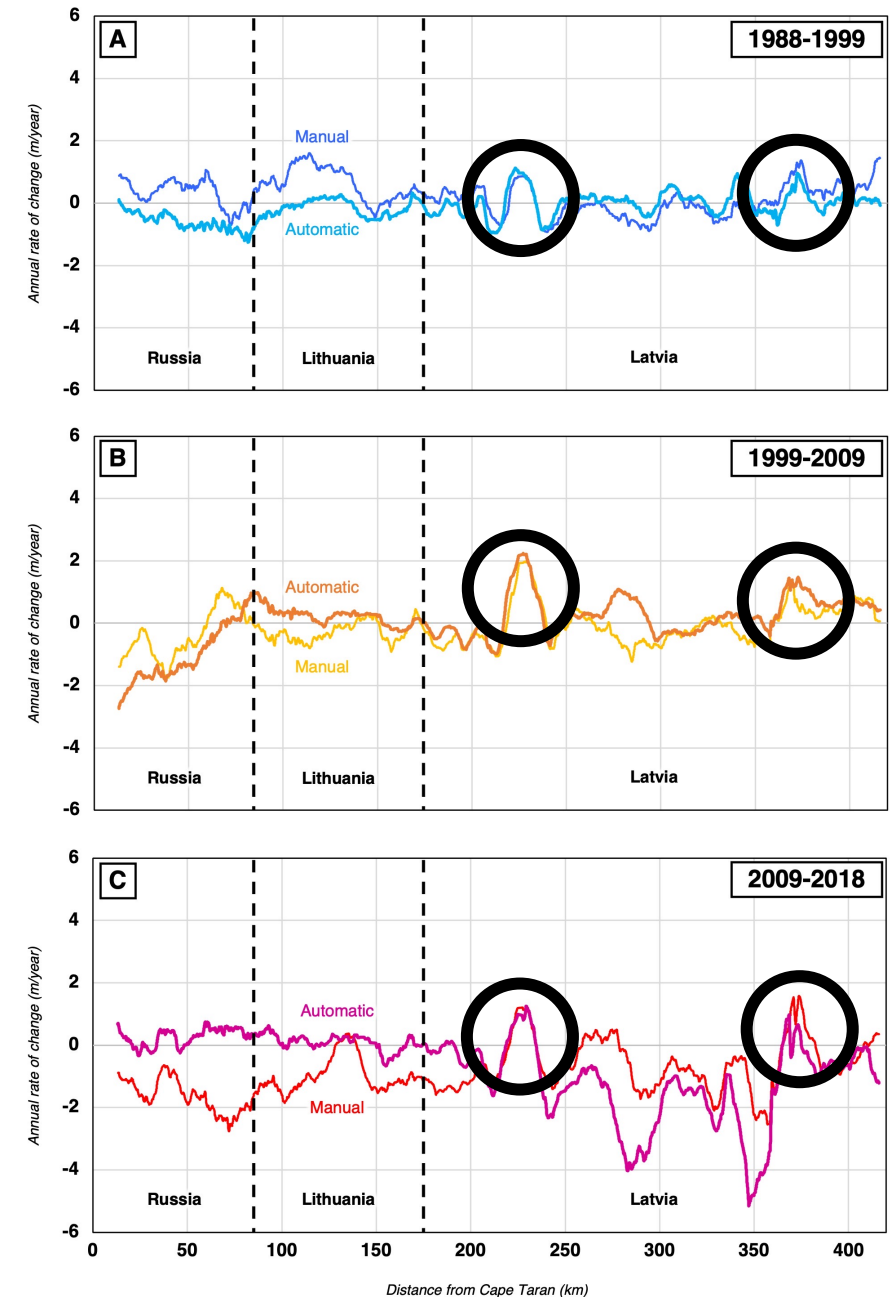

## **Natural and anthropogenic factors explaining the evolution of the coastline**

## Natural and anthropogenic factors explaining the evolution of the coastline

- An alternation between eroding and accreting areas (1988-1999) representative of sediment redistribution by longshore drift.

## Natural and anthropogenic factors explaining the evolution of the coastline

- An alternation between eroding and accreting areas (1988-1999) representative of sediment redistribution by longshore drift.

*Intense erosion or changing pre-existing spatial dynamics?*

## Natural and anthropogenic factors explaining the evolution of the coastline

- An alternation between eroding and accreting areas (1988-1999) representative of sediment redistribution by longshore drift.

*Intense erosion or changing pre-existing spatial dynamics?*

- Natural processes: sea level rise, increase in "extreme" events, etc.

## Natural and anthropogenic factors explaining the evolution of the coastline

- An alternation between eroding and accreting areas (1988-1999) representative of sediment redistribution by longshore drift.

*Intense erosion or changing pre-existing spatial dynamics?*

- Natural processes: sea level rise, increase in "extreme" events, etc.
- Extremely limited human intervention: beach nourishment, 'natural' dune protection solutions, etc.



## Natural and anthropogenic factors explaining the evolution of the coastline

- An alternation between eroding and accreting areas (1988-1999) representative of sediment redistribution by longshore drift.

*Intense erosion or changing pre-existing spatial dynamics?*

- Natural processes: sea level rise, increase in "extreme" events, etc.
- Extremely limited human intervention: beach nourishment, 'natural' dune protection solutions, etc.

*A coastline more sensitive to human-induced damage?*

## Natural and anthropogenic factors explaining the evolution of the coastline

- An alternation between eroding and accreting areas (1988-1999) representative of sediment redistribution by longshore drift.

*Intense erosion or changing pre-existing spatial dynamics?*

- Natural processes: sea level rise, increase in "extreme" events, etc.
- Extremely limited human intervention: beach nourishment, 'natural' dune protection solutions, etc.

*A coastline more sensitive to human-induced damage?*

- Disturbance of sedimentary stocks and inputs: weakening of dunes, extraction activities, etc.

## Natural and anthropogenic factors explaining the evolution of the coastline

- An alternation between eroding and accreting areas (1988-1999) representative of sediment redistribution by longshore drift.

### *Intense erosion or changing pre-existing spatial dynamics?*

- Natural processes: sea level rise, increase in "extreme" events, etc.
- Extremely limited human intervention: beach nourishment, 'natural' dune protection solutions, etc.

### *A coastline more sensitive to human-induced damage?*

- Disturbance of sedimentary stocks and inputs: weakening of dunes, extraction activities, etc.
- The case of ports: a disturbance of the littoral drift which causes local erosion of beaches downstream of port structures.

Hard structures in Klaipeda port  
(Gloaguen, 2020)

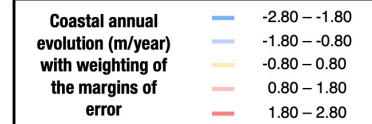
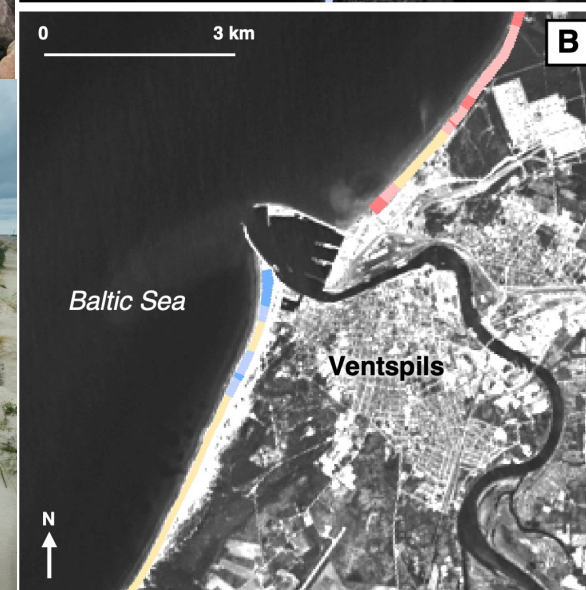
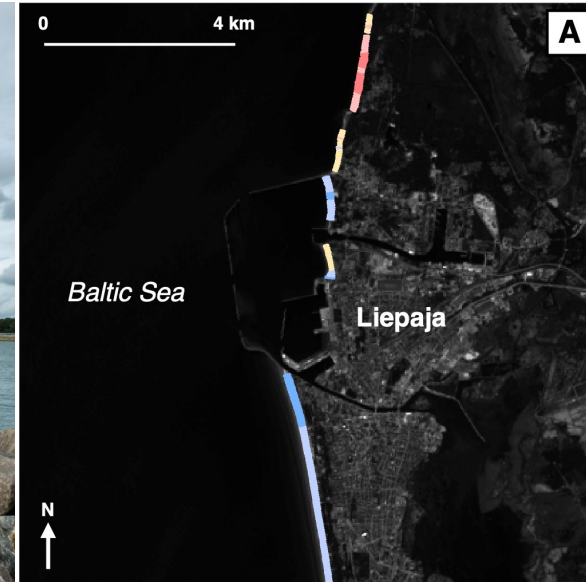

## Critical analysis of the methodology

Automatic method

Manual method

## Critical analysis of the methodology

Automatic method

Manual method

Time-processing



## Critical analysis of the methodology

	Automatic method	Manual method
Time-processing	+	-
Accuracy of the shoreline extraction	-	+

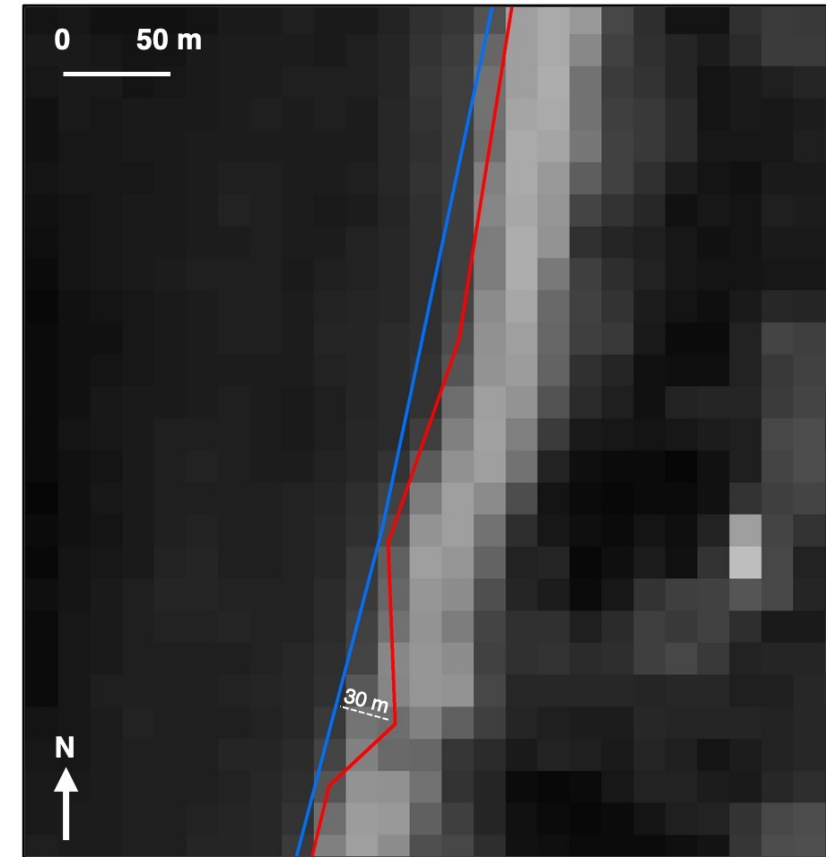

## Critical analysis of the methodology

	Automatic method	Manual method
Time-processing	+	-
Accuracy of the shoreline extraction	-	+
Results	+	-

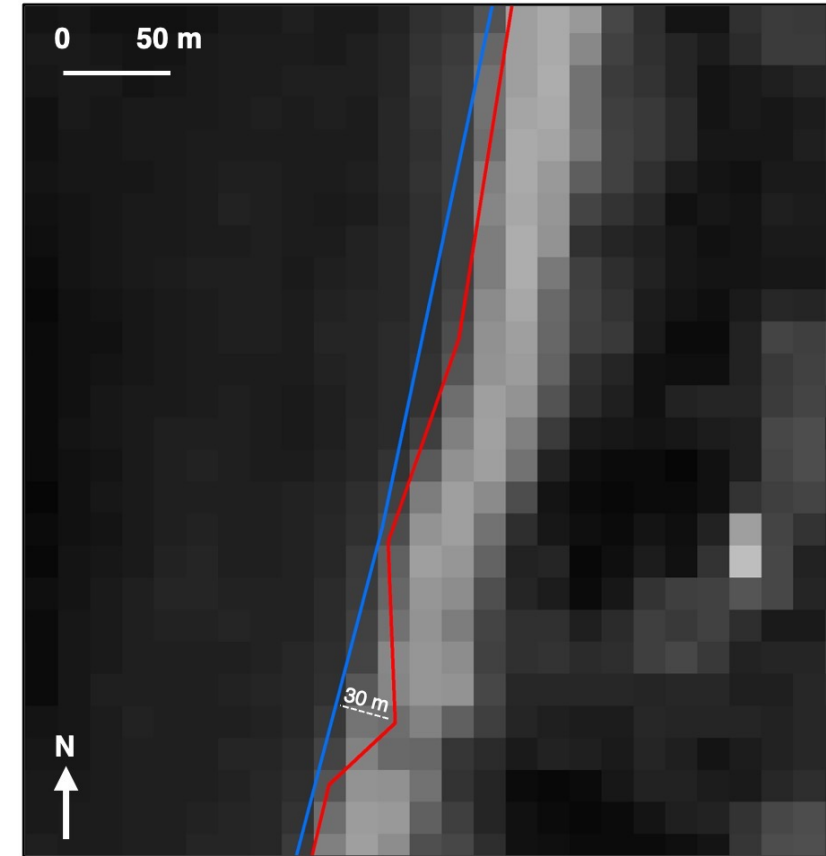

## Critical analysis of the methodology

	Automatic method	Manual method
Time-processing	+	-
Accuracy of the shoreline extraction	-	+
Results	+	-

- A relationship between spatial resolution and sandy beaches can be questioned ...

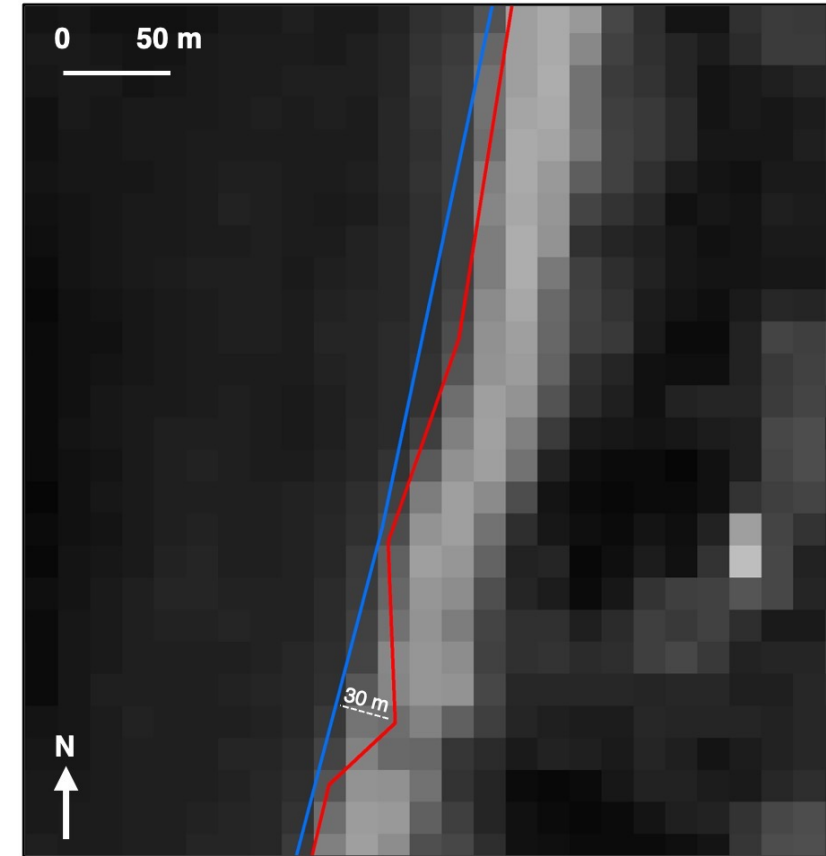



## Critical analysis of the methodology

	Automatic method	Manual method
Time-processing	+	-
Accuracy of the shoreline extraction	-	+
Results	+	-

- A relationship between spatial resolution and sandy beaches can be questioned ...
- Integration of other data sources in the analysis (topographic maps, field measurements, etc.)

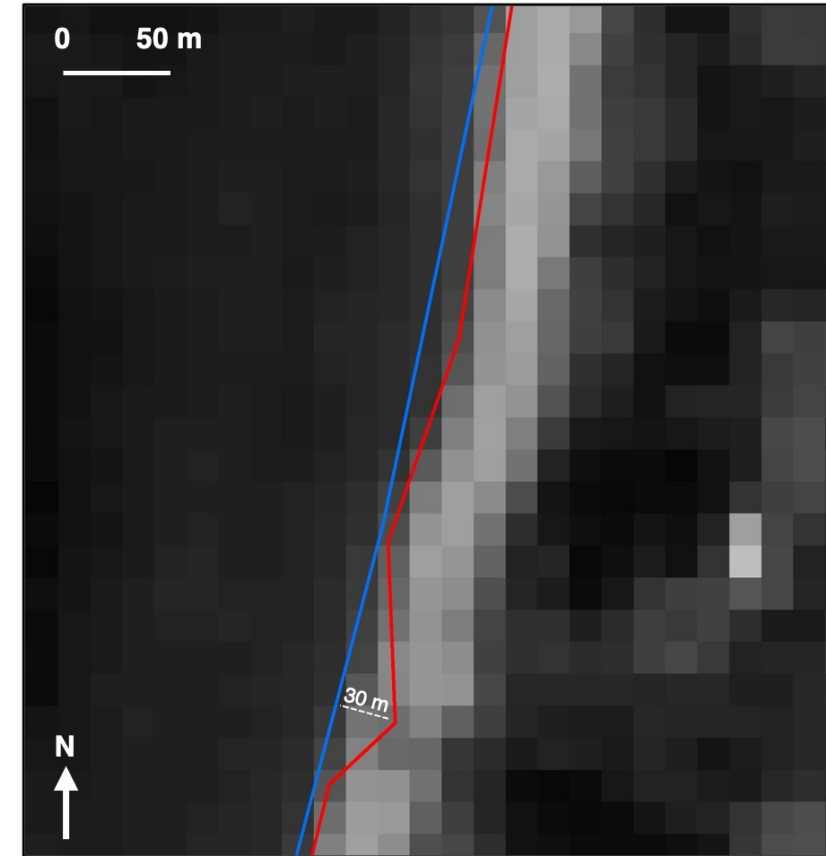

## Critical analysis of the methodology

	Automatic method	Manual method
Time-processing	+	-
Accuracy of the shoreline extraction	-	+
Results	+	-

- A relationship between spatial resolution and sandy beaches can be questioned ...
- Integration of other data sources in the analysis (topographic maps, field measurements, etc.)
- Use of satellite images with better spatial resolution (at the expense of spectral resolution?)

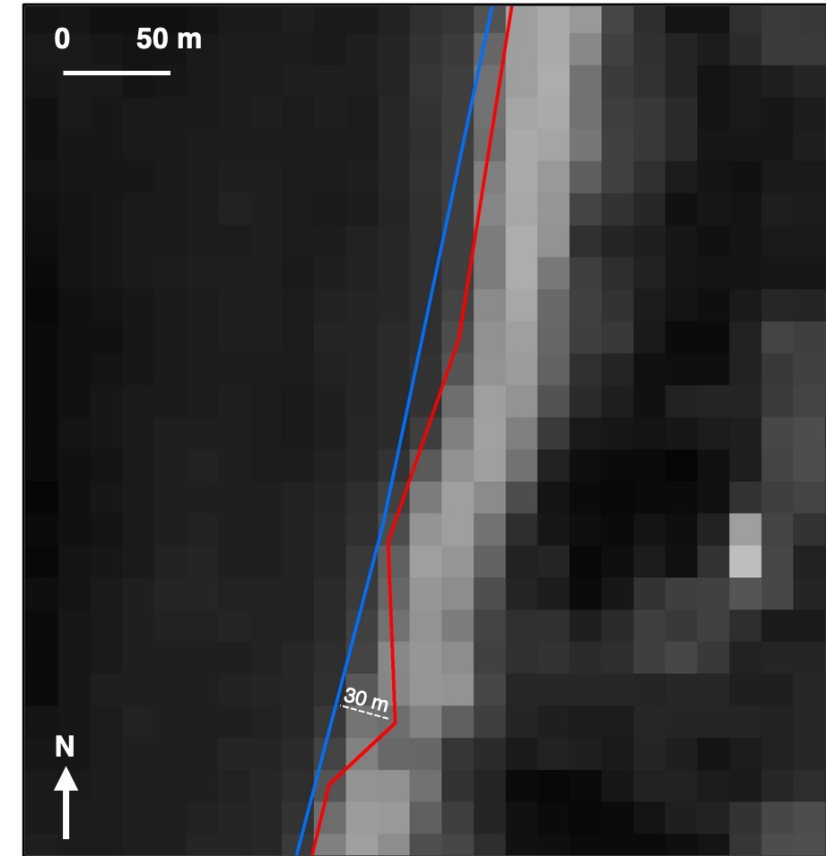

## Conclusions



## Conclusions

- Using Landsat 4-5 TM and Landsat 8 OLI satellite images, we measured a stable coastline evolution in the south-eastern Baltic Sea between 1988 and 2018.



## Conclusions

- Using Landsat 4-5 TM and Landsat 8 OLI satellite images, we measured a stable coastline evolution in the south-eastern Baltic Sea between 1988 and 2018.
- The annual changes per decade show further trends towards a disruption of the cyclical evolution that characterised the study coastline (erosion more intense or change in spatial dynamics of coastline evolution).



## Conclusions

- Using Landsat 4-5 TM and Landsat 8 OLI satellite images, we measured a stable coastline evolution in the south-eastern Baltic Sea between 1988 and 2018.
- The annual changes per decade show further trends towards a disruption of the cyclical evolution that characterised the study coastline (erosion more intense or change in spatial dynamics of coastline evolution).
- Natural (sea level rise, storms) and anthropogenic (dune degradation, coastal protection strategies, etc.) factors can explain these observed changes.



## Conclusions

- Using Landsat 4-5 TM and Landsat 8 OLI satellite images, we measured a stable coastline evolution in the south-eastern Baltic Sea between 1988 and 2018.
- The annual changes per decade show further trends towards a disruption of the cyclical evolution that characterised the study coastline (erosion more intense or change in spatial dynamics of coastline evolution).
- Natural (sea level rise, storms) and anthropogenic (dune degradation, coastal protection strategies, etc.) factors can explain these observed changes.
- The automatic extraction method (MNF transformation and Laplacian filter) showed its advantages in terms of processing time and robustness of the results even if the differences observed between the two methods remain insignificant.





**Thank you for your attention!**