



HAL
open science

Keynote: Physical Modelling Facilities: from Galileo to 3D Printing

Luc Thorel

► **To cite this version:**

Luc Thorel. Keynote: Physical Modelling Facilities: from Galileo to 3D Printing. Congrès international ICPMG 2022, organisé à Daejeon en Corée, Korean Geotechnical Society, pp.64-72, 2022, 978-89-952197-7-5. hal-04073064

HAL Id: hal-04073064

<https://hal.science/hal-04073064>

Submitted on 18 Apr 2023

HAL is a multi-disciplinary open access archive for the deposit and dissemination of scientific research documents, whether they are published or not. The documents may come from teaching and research institutions in France or abroad, or from public or private research centers.

L'archive ouverte pluridisciplinaire **HAL**, est destinée au dépôt et à la diffusion de documents scientifiques de niveau recherche, publiés ou non, émanant des établissements d'enseignement et de recherche français ou étrangers, des laboratoires publics ou privés.

INTERNATIONAL SOCIETY FOR SOIL MECHANICS AND GEOTECHNICAL ENGINEERING

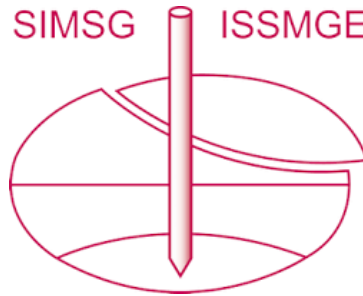

This paper was downloaded from the Online Library of the International Society for Soil Mechanics and Geotechnical Engineering (ISSMGE). The library is available here:

<https://www.issmge.org/publications/online-library>

This is an open-access database that archives thousands of papers published under the Auspices of the ISSMGE and maintained by the Innovation and Development Committee of ISSMGE.

The paper was published in the proceedings of the 10th International Conference on Physical Modelling in Geotechnics and was edited by Moonkyung Chung, Sung-Ryul Kim, Nam-Ryong Kim, Tae-Hyuk Kwon, Heon-Joon Park, Seong-Bae Jo and Jae-Hyun Kim. The conference was held in Daejeon, South Korea from September 19th to September 23rd 2022.

Physical modelling facilities: from Galileo to 3D printing

L. Thorel

GERS-CG, Univ Gustave Eiffel, IFSTTAR, F-44344 Bouguenais, France

ABSTRACT: An illustration of the development of Physical Modelling methodology and facilities is proposed through time, with some examples related to the Uni Eiffel Geo-Centrifuge, and some applications from the current research projects. New sensing, new devices and possible perspectives offered to Physical Modelling in Geotechnics are presented.

Keywords: Centrifuge, physical modelling facilities, history, sensing, devices.

1 INTRODUCTION

Using the physical modelling approach for studying a geotechnical question requires following some basic definitions. The one provided on the occasion of the Zurich Conference (Springman et al., 2010) covers the whole topic: “A geotechnical physical model is a simplified physical representation of a finite boundary problem for which similarity is sought in the context of adapted scale laws. A key aspect of physical modeling is the idealization process adopted to represent the soil behavior, geometric effects, loads, construction and environmental effects leading to the dimensioning of the model. The model will then be built mainly with a soil (or analog soil), which has been artificially reconstructed or transported from its natural repository to the laboratory.” The way to reach such a description of physical modelling has started almost four centuries ago with simple observations. Then a methodology to study small scale models developed gradually, to generate very specific facilities devoted to geotechnics. A description of the recent developments around the geo-centrifuge of the University Gustave Eiffel is then followed by some perspectives for physical modelling, including recent technologies, like 3D Printing.

2 THE IDEA OF CHANGING THE SCALE

The idea of using small scale models for representing full scale (prototype) objects comes from the beginning of the human being history. Nevertheless, the first scientist who showed an interest on small-scale models for representing the reality is certainly Galileo. In his “Discorsi” (1638) he proposed two observations very pertinent for physical modelers:

1) “the larger machine, built of the same material and in the same proportion as the smaller, corresponds with exactness to the smaller in every respect except that it will not be so strong or so resistant against violent

treatment; the larger the machine, the greater its weakness”. He suggests that similar geometry does not induces necessarily similar behavior.

2) “If one wishes to maintain in a great giant the same proportion of limb as that found in an ordinary man he must either find a harder and stronger material for making the bones”. He shows ther that similar geometry could be an ostacle to Nature, Structure and Behaviour. An interpretation (Fig.1) could be done with the analysis of the force balance, the weight being linked to the volume and the bearing capacity to the surface. As a proof of this intuition, it has been observed that Children's bones have a lower modulus than adult bones and they absorb more energy before fracturing (Medix, 2022).

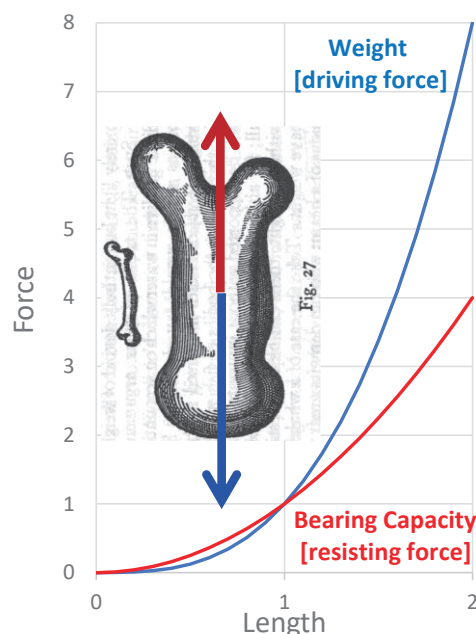

Fig. 1. The question of “Giant bones” (from Galileo, 1638).

On the question of heat propagation (Dhombres and Robert, 1998), several well-known scientists provided

food for thought: Newton (1704) suggested that a larger globe cools proportionally more slowly than a smaller one, after asserting the opposite. Buffon (1776) carried out a lot of experiments on the cooling of heated iron balls, and attempted to deduce a possible age of the earth, estimated at 74 832 years!). In 1822, Fourier not only introduced the notion of heat flux, he used the notion of similarity to validate this concept on two experiments of different sizes (Fig.2). In addition, it lays the foundations of dimensional analysis by establishing the need for dimensional homogeneity in any equation. Since then, his name has been given to a dimensionless number used in dimensional analysis and in application of the π or Vashy-Buckingham theorem, coined by Vashy (1892) and completed by Buckingham (1914).

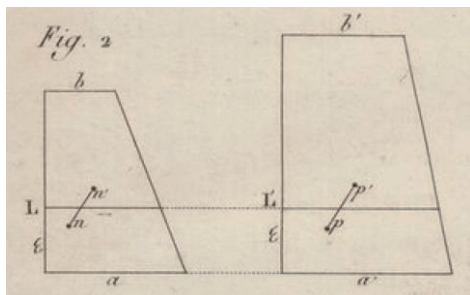

Fig. 2. The use of two scales of 2D experiments for validating the concept of heat transfer (Fourier, 1822).

3 FACILITIES

In the field of geotechnics, if centrifuge modelling is certainly the most versatile device, other equipment has been used and are still used for particular applications (Thorel and Garnier, 2002).

3.1 Base-friction table

This approach, presented in details by Bray and Goodman (1981), is based on the mobilization of friction on the lateral face of a 2D model through a belt (Fig. 3).



Fig. 3. Base-friction table in EPF Lausanne, Switzerland (courtesy from P. Egger).

The friction simulates an increase of gravity corresponding

to the scale of the model. It is used mainly for rock mechanics applications, like tunnels (e.g. Karaca, 1991) or slope instability.

3.2 Hydraulic gradient

This technique, coined by Zelikson in the sixties (1969), also generates additional forces on the small-scale model in order to simulate scaled stresses. It is based on the grains of a soil mass with a connected porosity, in which a continuous water flow is applied (Fig. 4). The hydraulic gradient applied generates the required forces. This technique has been brought up to date for application with transparent soils (Yuan et al., 2020).

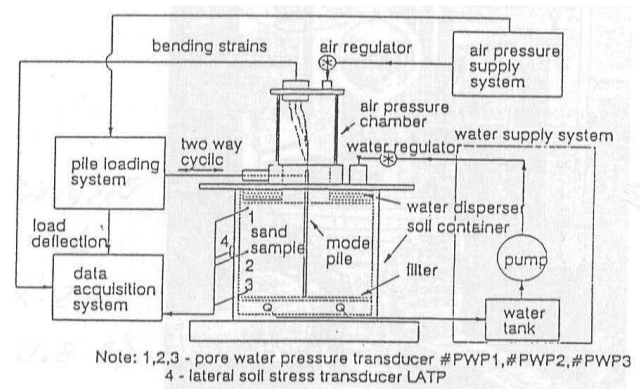

Fig. 4. Hydraulic Gradient (Zelikson, 1969).

3.3 1g experiments

- Small-scale tunnels

To study experimentally the soil-structure interaction during tunneling, including the technological developments, is so complex to miniaturize that only intermediate scales are representative. For instance, in the case of the effect of tunneling on pre-existing piles, a TBM such as the one of ENTPE in Lyon (Fig.5) could be used (Bel et al., 2016). Its dimensions allow to reproduce the settlement profiles in the vicinity of the tunnel front.

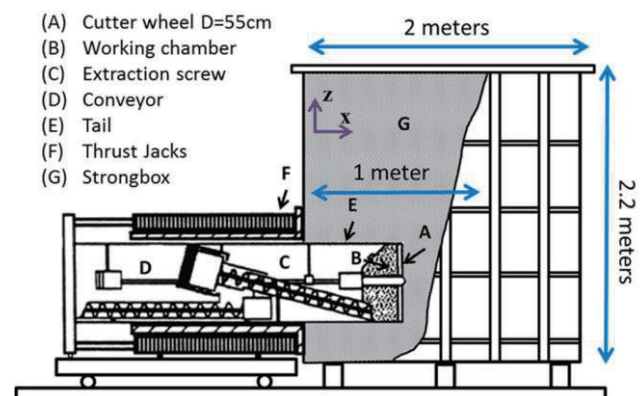

Fig.5. Scheme of the ENTPE (Lyon, France) earth pressure balance shield model (Bel et al., 2016).

- Underground movements

For studying the damage to structures owing to underground movements, such as settlement, subsidence and sinkhole, a 6m³ physical model has been developed in Ineris (Fig.6). 15 electric jacks below the device control the vertical displacement of trap doors.



Fig.6. The Ineris device for simulating underground movements, controlled by a set of jacks located under the soil (Al Heib et al., 2020, 2021).

- Miscellaneous

Several adapted devices have been developed for testing geothermal pile (e.g. Yavari et al., 2014, Tang et al., 2021) or investigating shaft friction on piles using X-ray apparatus (e.g. Doreau-Malioche et al., 2018, 2021). The behavior of a shallow foundation on soil reinforced by Mixed Module Columns (Lambert, 2021) has been explored using a tank equipped with cyclic loading jacks. The contact erosion in canal embankments has been studied on full scale models (Beguin et al., 2021), in order to characterize the induced failure.

The European Programme GEOLAB (Peters et al., 2022) regroups also interesting original facilities for physical modelling such as the Darmstadt Pile Foundation Test Pit, the Deltares GeoModel Container, the CEDEX Track Box or the TU Delft Liquefaction tank.

3.4 Centrifuge facilities

The most versatile technique in the field of physical modelling in geotechnics is certainly the centrifuge approach. About 200 geo-centrifuges have been installed all over the world (several have been dismantled or moved), mainly in Japan, USA, Europe and China. A way of presenting the geo-centrifuge characteristics is to use the log-log diagram where the Payload is linked to the maximum acceleration (Fig.7). Among the 143 geo-centrifuges for which the characteristics were available in the literature, 9 are in the upper range (>1000g-ton), 56 in the second one (between 100 and 1000 g-ton), 61 between 10 and 100g-ton and 5 under 1g-ton.

The geo-centrifuge of the Uni Eiffel (Fig.8), inaugurated in 1985 is a 200 g-ton facility. A retrofit of the engine line (Gaudicheau et al., 2022) has been done in 2021. Thanks to 21st century technologies, upgrades

have been made both on the motor (a 450kW Siemens low-voltage motor with a regenerative drive system) and on the control system, moving to digital world.

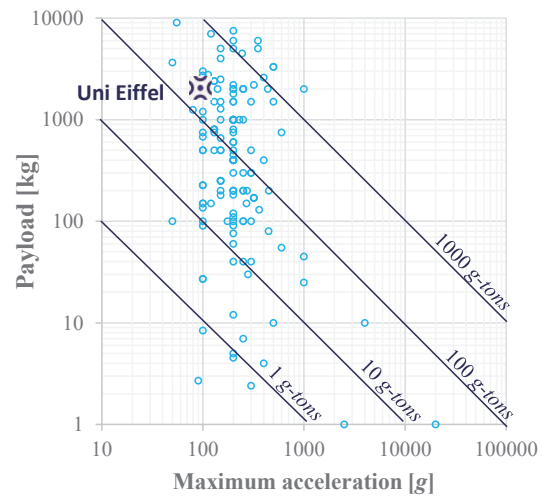

Fig.7. The Capacities of the geotechnical centrifuges.

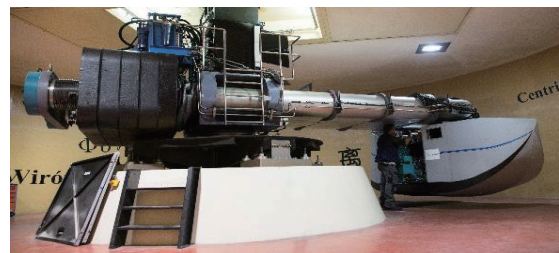

Fig.8. The Uni. Eiffel geotechnical centrifuge in Nantes, France.

An overview (Fig.9) of the scientific and technical

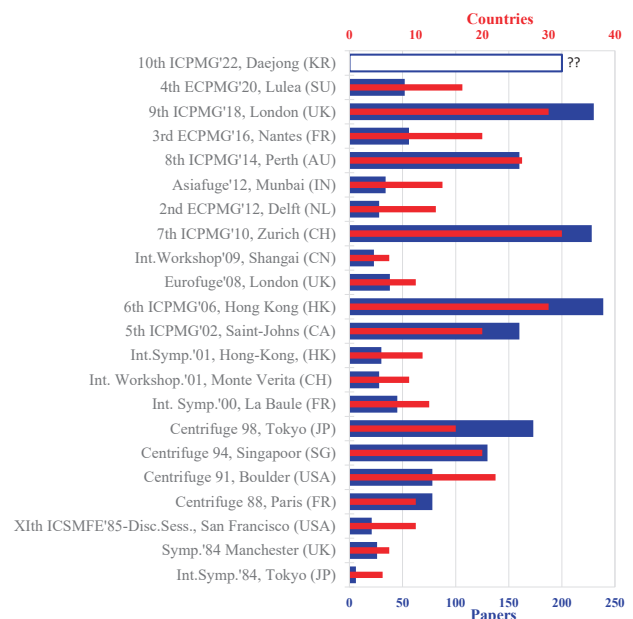

Fig.9. Physical modelling in geotechnics' conferences (from Thorel and Jenck, 2021).

activities in the field of physical modelling in geotechnics is illustrated by a series of conferences initiated in 1984, at the international or regional scale with nowadays a periodicity of 4 years, completed by the regular publication of the International Journal of Physical Modelling in Geotechnics (since 2001).

4 RECENT DEVELOPMENTS ON THE UNI EIFFEL CENTRIFUGE

The Nantes’ geo-centrifuge has developed for more than 36 years a series of embarked ancillary equipment, such as the 4-axes robot (Fig.10) and the 1D-earthquake simulator (Fig.11).

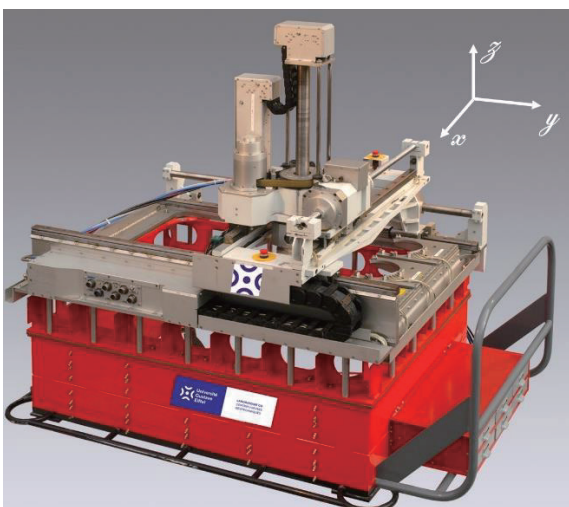

Fig.10. Four-axes robot (from Gaudicheau et al., 2014).



Fig.11. 1D earthquake simulator (from Chazelas et al., 2008).

An example (Fig. 12) of the use of the robot concerned pipeline end termination (PLET) structures used in subsea deep-water developments, which are subjected to significant axial forces arising from heating

up and cooling down production periods of the incoming pipelines. Resisting these forces with a fixed foundation would lead to excessive sizes when axial expansions are large. Allowing the foundation to slide over the seabed as a whole could lead to a more economical solution. To design this foundation, its displacements and rotations during several cycles of large-amplitude must be precisely characterised. Series of scale model tests in the centrifuge have been performed to understand the complex behaviour of this foundation.

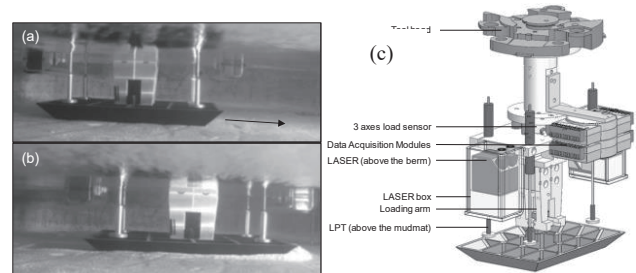

Fig.12. Sliding PLET tested at 50g with the robot. 1st large-displacement episode: (a) before and (b) after. Sliding mudmat tool (c). Adapted from Blanc et al. (2016).

The study on the different behavior of batter and vertical pile foundations in terms of stiffness degradation and damping properties under dynamic loadings (Fig.13) is a recent example of results obtained with the on-board earthquake simulator (Li et al., 2020).

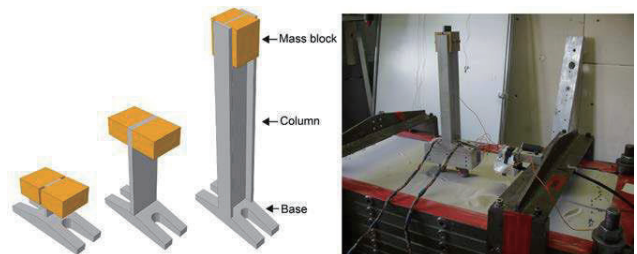

Fig.13. Superstructures tested and centrifuge model (scale 1/40), from Li et al. (2020).

Both the robot and the earthquake simulator will be soon used for experimental research on Soil Reinforcement with vertical Rigid Inclusions (ASIRI+ research project 2019-2024).

4.1 Optical Fibres

A circular aluminum tube 50 mm in diameter was instrumented with two optical fibres (Fig. 14), each of which consists of 13 fibre Bragg grating sensors (FBGS). One “point” of measurement requires about 6mm length. The spacing between two “points” 25 or 50mm, in order to obtain a profile along the model pile. The performance of the FBGS was evaluated by applying a series of increasing transversal loads at 1g level and comparing the strains measured by FBGS with those calculated from the Euler–Bernoulli beam theory. A centrifuge test was then conducted at 100g to estimate the transversal

response of the calibrated model pile that had been jacked 450 mm into saturated sand and horizontally loaded at 500 mm above the ground. The profiles of the normal strain, bending moment, soil reaction and pile deflection were measured or determined, enabling the plotting of the soil reaction–pile deflection (P – y) curves. The results confirmed the reliability of FBGS at 100g by yielding satisfactory results on bending moments and coherent measurements on shear force at the ground level. An additional application concerned the effects of embedding depth and load eccentricity on lateral response of offshore monopiles in dense sand (Li et al., 2021, Blanc et al., 2022)

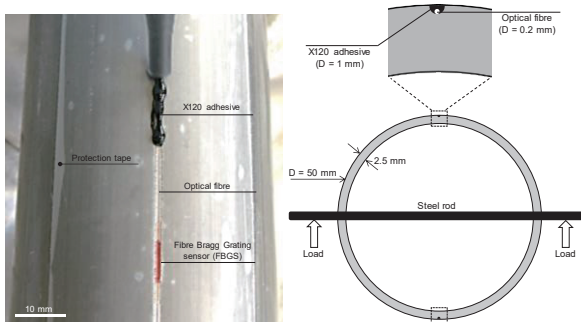

Fig. 14. Instrumentation of the model pile: (left) FBGS embedment, (right) transversal section at the steel rod level. Adapted from Li et al. (2019).

4.2 Impact driving of monopiles

A special device including small-scale hammer was developed (Fig. 15) to install open-ended monopiles with 50 mm in diameter to an embedment depth of 250 mm in flight, at 100g (Maatouk et al., 2021, 2022), and then to apply lateral loading on the monopile head without stopping the centrifuge (Fig.16).

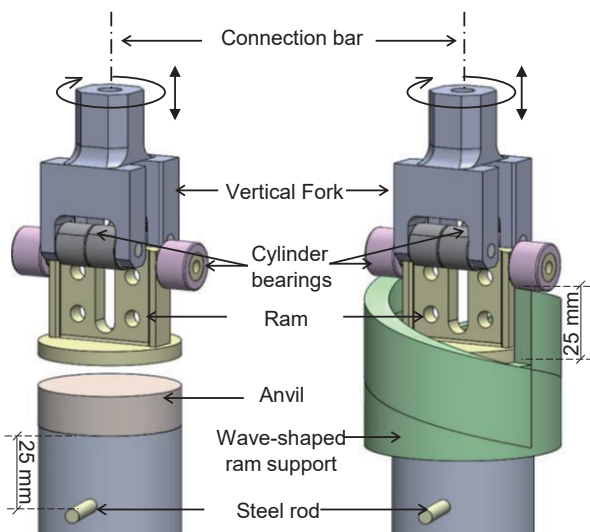

Fig.15. The electro-mechanical hammer principle is based on the combined spin-upward movement of the ram before free-fall (adapted from Maatouk et al., 2021).

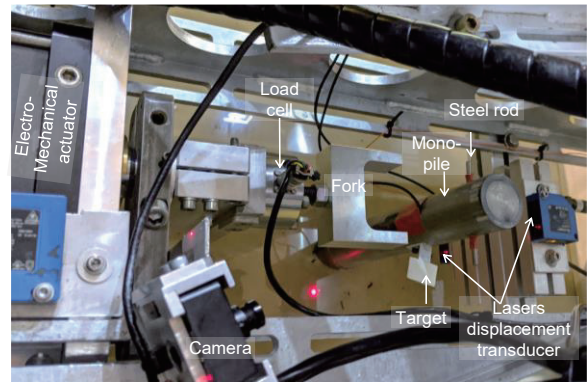

Fig.16. Top view of the experimental set up after a test including impact driving and lateral loading. The “fork”, connected to the electro-mechanical actuator, applies the horizontal load on the “steel rod” of the monopile at scale 1/100 (Maatouk et al., 2021).

4.3 Rolling Test Device

To study the development of liquefaction in ore cargo during maritime transportation, a new Rolling Test has been designed to support similar stresses than those observed in a vessel (Thorel et al., 2017, 2018). It can be used in an 80g macrogravity field (Fig. 17). The objectives were: 1) to observe; 2) to understand; 3) to simulate liquefaction of ore cargo and 4) to test countermeasures on small-scale models to avoid this phenomenon. With iron concentrate (initial void ratio of 0.8), it has been observed that very low effective stresses develop close to the vertical boundaries of the rolling container (Rousset and Thorel, 2018).

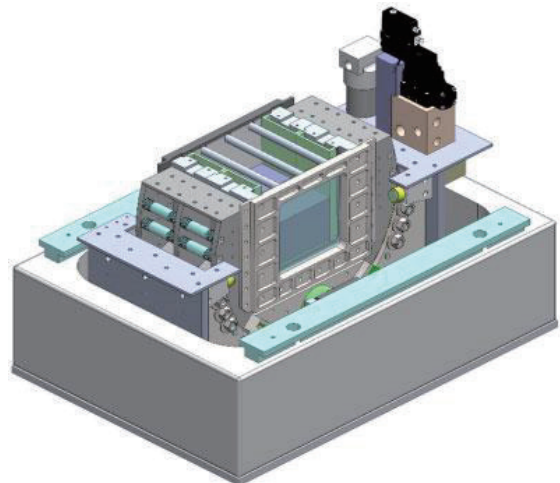

Fig. 17. Rolling Test Device (Thorel et al., 2018). The angle of rolling varies from -25° to $+25^\circ$ for a max angular velocity of $60^\circ/s$.

4.4 Helical piles

The research on helical piles in Nantes have started with a collaboration with the University of Sao Paulo (Tsuha et al., 2007, 2012; Schiavon et al., 2016, 2017, 2019; Perez et al. 2018), including pre-installed piles, in-flight installed piles, static and cyclic loading. In the perspective of the development of floating wind turbines,

helical pile should be used as an anchoring system. The installation plays an important role, especially in dense sand, due to remolding and, if dilatancy develops, a change of stresses around the helix is expected. The device developed in Un Eiffel allows an accurate control of the installation, the vertical speed corresponding to one helix pitch per round. Both the vertical force and the torque are recorded during the installation. Then the loading could be in tension or in compression (Fig. 18).

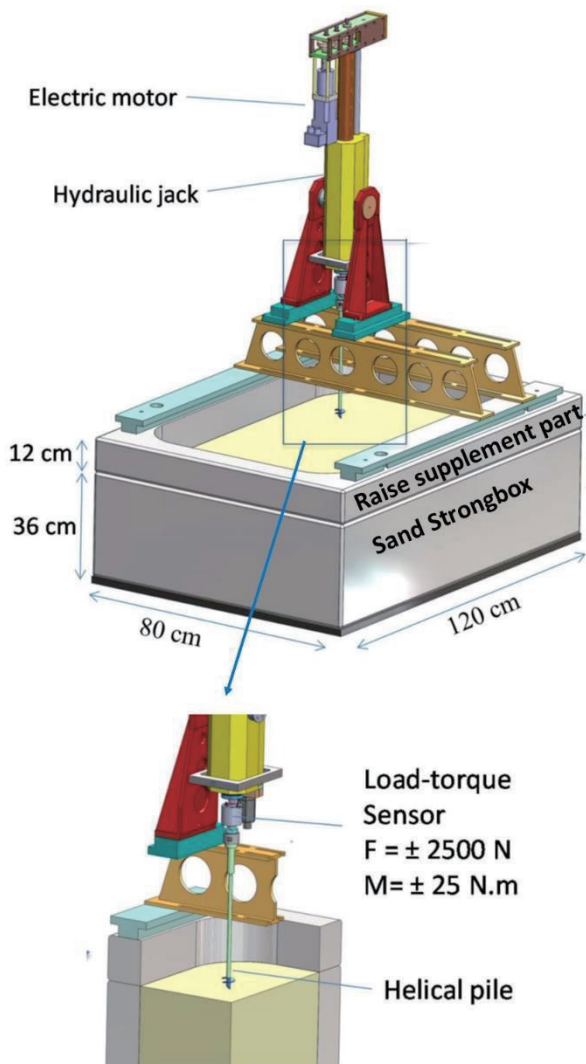

Fig. 18. Helical pile combined installation and load device (From Thorel et al., 2020).

4.5 Mobile tray

The mobile tray device has been developed for studying 3D load transfer in pile-supported earth platform (Rault et al. 2010). A composite foundation made of reinforced soft soil surmounted with a load transfer platform (LTP) displays mechanisms such as “arching” in this LTP. In order to study the parameters of the LTP, such as its density, its nature, its particle size distribution, its height and the influence of the distance between the vertical stiff inclusions, the soft soil is being

replaced by a perforated tray, which moves vertically (Fig.19).

The research has included granular material (sand) for the LTP (Okyay et al., 2014; Fagundes et al., 2015) and geosynthetic reinforcement (Blanc et al., 2013, 2014; Fagundes et al., 2017; Girout et al., 2014, 2016, 2018; Almeida et al., 2020). A new set of research is underway to study the geosynthetic cover, regarding the location of the Rigid Inclusions lines, in the framework of the ASIRI+ Project.

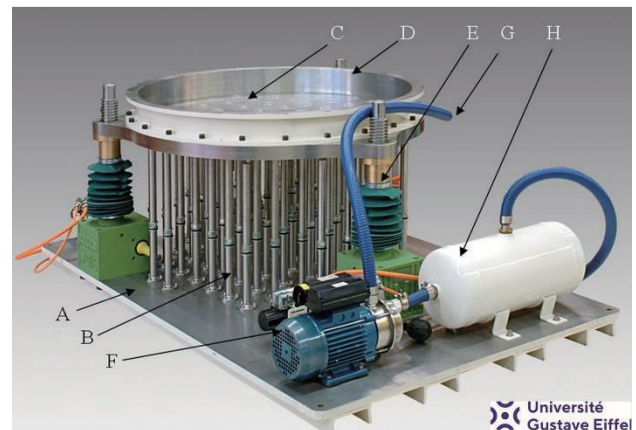

Fig. 19. Mobile Tray Device (from Rault et al., 2010). A) steel plate support, B) rigid inclusions (stiff piles), C) mobile tray, D) intermediate steel ring, E) electric actuator, F) pump, G) emptying pipe, H) additional water tank.

4.6 Rolling Load on Granular LTP

Another question, raised in ASIRI+, is the effect of the Rolling Load on the load transfer in the LTP towards the rigid inclusions. Are the chains of force maintained or modified after one or several movements of a wheel on thin structures? For that a 2D experiment (Fig. 20) has been designed (Dubreucq et al., 2022).

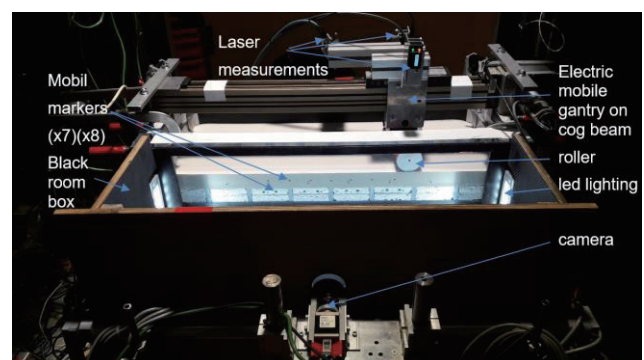

Fig. 20. The 2D roller experiment (Dubreucq et al., 2022).

The 2D rolling load consists of an outer steel tube ($\varnothing=6\text{cm}$), inside which can fit an intermediate tube ($\varnothing=4\text{cm}$) and a bar ($\varnothing=2\text{cm}$). Their masses are 2.9; 1.8 and 0.6 kg respectively to simulate increasing loads. The container with a transparent face is made of U-shape

structures which can be connected together for increasing the size of the model in the direction normal to the window.

5 NEW DIRECTIONS AND PERSPECTIVES FOR PHYSICAL MODELLING

As Physical Modelling in Geotechnics is an experimental approach, it requires a lot of know-how, which is provided by each member of the team, from the technician to the researcher. The technical developments are of importance to contribute to this empirical research field. Also investigated, the “recent” field of 3D printing is opening new perspectives. Ultimately the comparison with analytical and mainly numerical methods is becoming common place.

5.1 Technology

The development of physical modelling in geotechnics is linked to the technology: smaller and cheaper sensors for the instrumentation of the models, small-size but high performance of Data Acquisition Systems and control-command apparatus, etc... Technological watch is part of the daily life of experimenters on small-scale models, in particular in macrogravity. A set of new materials and new sensing can be found in Thorel et al. (2022), including shape arrays, miniature sensors, multifunctional sensors, fibre-optic sensors, wireless sensing systems and non-contact measuring systems.

5.2 Three-dimensional Printing

“3D printing, also known as additive manufacturing, is the exact opposite of the traditional way of making objects. Instead of machining or “subtracting” material to form an object - much like how a sculptor cuts away clay - 3D printing adds layer upon layer of material to build an object, but only where it’s needed. Product designers and engineers upload a digital (Computer Aid Design or CAD) file to a 3D printer, which then prints a solid 3D object. Thermoplastics are the most frequently used materials, but the technology also includes photopolymers, epoxy resins, metals, and more. Cutting-edge bioinks, which use a mixture of human cells and gelatin, have also been leveraged to 3D print complex tissue models. Even edible materials such as chocolate are being used in 3D printers.” (Stratasys, 2022).

In the field of geotechnics (Thorel et al., 2022), granular material can be printed, not only with spherical shape, but also with more complex geometries like Platonic solids. Nevertheless, the typical size of the particle requires several millimeters. The grading curve should be scaled by a factor (e.g. 4 to 16 for Adamidis et al., 2019). The size and surface roughness of 3D printed particles are far from those of real granular particles. How to address this “scale effect” will be another challenge. In the end, although significant developments

have been made in 3D printing technologies, the efficiency of printing particles in large scale is still low relative to the number of particles we are facing in any problem involving granular materials.

3D printing of clay has been developed recently in the University of Los Andes by Pua and Caicedo (2020) to create samples generated from a liquid limit random field; however, further studies are required to understand how to create model samples that reproduce other field properties and conditions.

The most extensive research in progress is certainly in the field of rock type material printing. The focus concerned the porosity and the permeability, the crack propagation, the stress distribution, the rock-joint behavior, but also the creation of small-scale models (Jaber et al., 2020).

5.3 Digital Twin

Physical modelling approach is used for observing, understanding, obtaining data through measurements, but also to compare and validate numerical developments. If the concept of “digital twin” is used in the manufacturing industry and in architecture, the dual approach consisting in comparing the experimental results with numerical ones is now common.

For instance, amazing work has been done using the powerful 3D printing technologies to replicate the complex morphology of granular particles. This new technology can already be used for validating the reliability of the molecular dynamics (MD) or discrete element modelling (DEM), at the same time, contributing to the multi-scale investigation of the mechanical and hydraulic behavior of granular materials.

If simplified numerical approaches in a sake of reducing the cost of calculation (e.g. 2D geometry, like in Saade et al., 2022), new avenues seem to be opening up to new generations, with the use of supercomputers. Particularly, the large strains calculations with MPM (Material Point Method) or CEL (Coupled Eulerian-Lagrangian) methodologies, when e.g. installation process of deep foundation is studied.

6 CONCLUSIONS

Physical Modelling Facilities include a lot of different aspects, linked to the theory (and the history), but also to the development of sensing and material technologies. New challenges will undoubtedly come from additive manufacturing, but also from the construction of digital twins. These advances will certainly reduce the empiricism inherent in physical models.

ACKNOWLEDGEMENTS

This work received support from several partners: 1) the National Research Agency (ANR-10-IEED-0006-08

& ANR-19-CE22-0015); 2) France Energies Marines (SOLCYP+); 3) Weamec (REDENV-EOL); 4) the Region des Pays de la Loire; 5) Subsea7; 6) ERANet MarTec (Maritime Technologies) via the French Ministry of Ecology, Sustainable Development and Energy, General Direction of Infrastructures, Transports and Sea (DGITM/SAGS/EP1); 7) IREX; 8) French Ministry of Ecological Transition; 9) CPER PRIIC-MER; 10) European Union's Horizon 2020 Grant Agreement No. 101006512. Assistance from the technical staff of the centrifuge group is greatly acknowledged.

REFERENCES

- Adamidis O., Alber S., Anastasopoulos I., 2019. Assessment of Three-Dimensional Printing of Granular Media for Geotechnical Applications. *Geotech. Testing J.* 43(3): 641–659. <https://doi.org/10.1520/GTJ20180259>
- Al Heib M., Emeriault F., Nghiem H.L., 2020. On the use of 1g physical models for ground movements and soil-structure interaction problems. *J. Rock Mech. Geotech. Engng* 12, 197–211. <https://doi.org/10.1016/j.jrmge.2019.07.006>
- Al Heib M., Hassoun M., Nghiem H.-L., Emeriault F., Villard P., 2021. 1g physical modelling for studying the consequences of ground movements and means mitigation methods (in French). *Rev. Fr. Geotech.* <https://doi.org/10.1051/geotech/2021003>
- Almeida M.S.S., Fagundes D.D.F., Thorel L., Blanc M., 2020. Geosynthetic-Reinforced piled embankments: numerical, analytical and centrifuge modelling. *Geosynth. Int.* <https://doi.org/10.1680/jgein.19.00011> 27(3), 301–314.
- ASIRI+ Project (2019-2024). <https://asiriplus.fr/> (accessed on 18th July 2022)
- Beguín R., Duchesne L., Picault C., Fry J.J., Courivaud J.R., Philippe P., 2021. Physical modelling for initiation and progression of contact erosion through Rhine and Rhône canal embankments. *Rev. Fr. Geotech.*, 168. <https://doi.org/10.1051/geotech/2021014>
- Bel J., Branque D., Wong H., Viggiani G., Lossaco N., 2016. Impact of tunnelling on neighbouring piles: experimental study on 1g reduced scale model of TBM. *Eurofuge2016*, Nantes, France. https://www.issmge.org/uploads/publications/53/54/043_Bel_et_al.pdf
- Blanc M., Li Z.S., Thorel L., 2022. Centrifuge study of monopile embedment on its horizontal response in sand. *10th ICPMG*, 19-23sept. Daejeon, Korea.
- Blanc M., Rault G., Thorel L., Almeida M., 2013. Centrifuge investigation of load transfer mechanisms in a granular mattress above a rigid inclusions network. *Geotext. & Geomembr.* vol.36, pp.92-105. <http://dx.doi.org/10.1016/j.geotextmem.2012.12.001>
- Blanc M., Thorel L., Girout R., Almeida M., 2014 Geosynthetic reinforcement of a granular load transfer platform above rigid inclusions: comparison between centrifuge testing and analytical modelling. *Geosynth. Int.*, Febr., Vol.21, 1, pp.37-52. DOI: 10.1680/gein.13.00033
- Blanc M., Thorel L., Wallerand R., Stuyts B., 2016. Effect of soil profile on the response of a sliding subsea foundation. *Eurofuge 2016*, 1st-3rd June, Nantes. pp.295-300. https://www.issmge.org/uploads/publications/53/54/044_Blanc%20et%20al.pdf
- Bray J.W., Goodman R.E., 1981. The theory of base friction models. *Int. J. Rock Mech. Min. Sci. & Geomech. Abstr.*, vol18, 453-468, [https://doi.org/10.1016/0148-9062\(81\)90510-6](https://doi.org/10.1016/0148-9062(81)90510-6)
- Buckingham E., 1914. On physically similar systems: illustrations of the use of dimensional analysis. *Phys. Rev.* 4, 354-377.
- Buffon G.L., 1776. Natural history. Supplement to volume four (in french). <https://fr.wikisource.org/wiki> (accessed on 03/07/22).
- Chazelas J.-L., Escoffier S., Garnier J., Thorel L., Rault G., 2008. Original technologies for proven performances for the new LCPC earthquake simulator. *Bull. Earthqu. Engng.* Vol.6 (4) pp723-728. <https://doi.org/10.1007/s10518-008-9096-z>
- Dhombres J., Robert J.B., 1998. *Fourier, Creator of physics-mathematics (in french)*. Belin. 767p.
- Doreau-Malioche J., Combe G., Viggiani G., 2021. Grain-scale study of sand-pile interface under monotonic and cyclic axial loading (in French) *Rev. Fr. Geotech.* 166. <https://doi.org/10.1051/geotech/2021005>
- Doreau-Malioche J., Combe G., Viggiani G., Toni J.B., 2018. Shaft friction changes for cyclically loaded displacement piles: an X-Ray investigation. *Geotechnique Letters* 8, 66-72 <https://doi.org/10.1680/jgele.17.0014166>
- Dubreucq T., Thorel L., Lerat S., Jagu A., Neel A., 2022. 2D effect of rolling load on a granular platform above a soft soil reinforced by rigid inclusions. *10th ICPMG*, 19-23sept. Daejeon, Korea.
- Fagundes D.D.F., Girout R., Almeida M.S.S., Blanc M., Thorel L., 2015 Behaviour of piled embankments without reinforcement *Geotechnical Engineering* Vol.168, issue GE6, pp514-525. <http://doi.org/10.1680/geng.14.00155>
- Fagundes D.D.F., Almeida M., Thorel L., Blanc M., 2017 Load transfer mechanism and deformation of reinforced piled embankments. *Geotext. & Geomembr.* <http://doi.org/10.1016/j.geotextmem.2016.11.002>, 45(2), 1-10.
- Fourier J., 1822. *Analytic theory of heat (in french)*. F. Didot, Paris. <https://gallica.bnf.fr/ark:/12148/bpt6k1045508v/f677.item>
- Galileo Galilei, 1638. *Discorsi e dimostrazioni matematiche, intorno à due nuove scienze (Discourses and Mathematical Demonstrations Relating to Two New Sciences)*. <https://gallica.bnf.fr/ark:/12148/bpt6k3354x/fl1.item>
- Gaudicheau P., Néel A., Blanc M., Thorel L., Lecoq F., Pringue F., 2022. Retrofit of the centrifuge engine line of the Uni-Eiffel GeoCentrifuge. *10th ICPMG*, 19-23sept. Daejeon, Korea.
- Gaudicheau P., Thorel L., Néel A., Audrain Ph., Lozada C., Monroy J., 2014 Improvement of the IFSTTAR robot control system, *8th ICPMG*, Perth 14-17 January, pp.221-226.
- GEOLAB. <https://project-geolab.eu/> accessed on 1st July 2022.
- Girout R., Blanc M., Dias D., Thorel L., 2014. Numerical analysis of a geosynthetic-reinforced piled load transfer platform. Validation on centrifuge tests. *Geotext. & Geomembr.* 42, pp. 525-539. <https://doi.org/10.1016/j.geotextmem.2014.07.012>
- Girout R., Blanc M., Thorel L., Dias D., 2018. Geosynthetic reinforcement on piled-supported embankment *Geosynth. Int.* Vol.25, n°1 37–49. <https://doi.org/10.1680/jgein.17.00032>.
- Girout R., Blanc M., Thorel L., Fagundes D.F., Almeida M.S.S., 2016. Arching and deformation in a piled embankment: centrifuge tests compared to analytical calculations. *Journal of Geotechnical and Geoenvironmental Engineering* 142(12), 10p [https://doi.org/10.1061/\(ASCE\)GT.1943-5606.0001557](https://doi.org/10.1061/(ASCE)GT.1943-5606.0001557).
- Jaber J, Conin M, Deck O, Moumni M, Godard O, Kenzari S, 2020. Investigation of the Mechanical Behavior of 3D Printed Polyamide-12 Joints for Reduced Scale Models of Rock Mass. *Rock Mechanics and Rock Engineering* 53, 2687–2705. doi 10.1007/s00603-020-02064-9
- Karaca M.A., 1991. *Stability of shallow tunnels in discontinuous environments (in French)*, PhD thesis EPF Lausanne, n°945, 217p. 10.5075/epfl-thesis-945
- Lambert S., 2021. Behaviour of a shallow foundation on soil

- reinforced by mixed module columns: Experimental study (in french) *Rev. Fr. Geotech.* 168. <https://doi.org/10.1051/geotech/2021012>
- Li Z., Escoffier S., Kotronis P., 2020. Study on the stiffness degradation and damping of pile foundations under dynamic loadings. *Engng Struct.* 203. <https://doi.org/10.1016/j.engstruct.2019.109850>
- Li Z.-S., Blanc M., Thorel L., 2019. Using Fibre Bragg Grating Sensors to estimate the horizontal response of a monopile in geotechnical centrifuge. *Int. J. Phys. Mod. Geotech.* <https://doi.org/10.1680/jphmg.19.00022>
- Li Z.-S., Blanc M., Thorel L., 2021. Effects of embedding depth and load eccentricity on lateral response of offshore monopiles in dense sand: A centrifuge study. *Géotechnique*, <https://doi.org/10.1680/jgeot.21.00200>
- Maatouk S., Blanc M., Thorel L., 2021. Impact driving of monopiles in centrifuge: effect on the lateral response in sand. *Int. J. Phys. Mod. Geotech.* <https://doi.org/10.1680/jphmg.21.00035>
- Maatouk S., Blanc M., Thorel L., 2022. Impact of monopile hammering installation on the horizontal response in centrifuge. *10th ICPMG*, 19-23sept. Daejeon, Korea.
- Medix, 2022. <http://www.medix.free.fr/cours/biomecaniques-os.php> (accessed on 02/07/2022)
- Newton 1704 *Opticks or, a Treatise of the reflexions, refractions, inflexions and colours of light. Also, two treatises of the species and magnitude of curvilinear figures* <https://gallica.bnf.fr/ark:/12148/bpt6k3362k/f4.item#>
- Okyay U.S., Dias D., Thorel L., Rault G., 2014. Centrifuge modeling of a pile supported granular earth platform. *J. Geotech. Geoenvironment. Engng.* vol.140, n°2, 04013015-1 to 12. [https://doi.org/10.1061/\(ASCE\)GT.1943-5606.0001004](https://doi.org/10.1061/(ASCE)GT.1943-5606.0001004)
- Perez Z.A., Tsuha C., Dias D., Schiavon J.A., Thorel L., 2018. Numerical and experimental study on the influence of installation effects on the behaviour of helical anchors in very dense sand. *Can. Geotech. J.* Vol.55(8), 1067-1080. <https://doi.org/10.1139/cgj-2017-0137>
- Peters T., van Eekelen S., Anastasopoulos I., Korre E., Stanier S., Viggiani G., Askarnejad A., Muraro S., Zlender B., Lenart S., Estaire J., Santana M., Thorel L., Bessmann E., Le T.M.H., L'Heureux J.S., Zachert H., Beroya-Eitner M.A., Yankulova A., Singh M., 2022. GEOLAB: integrating and advancing Europe's physical modelling facilities. *10th ICPMG*, 19-23sept. Daejeon, Korea, 4p.
- Pua L.-M., Caicedo B., 2020. Reproducing the inherent variability of soils using a three-dimensional printer. *Int. J. Phys. Mod. Geotech.* 21(6). <https://doi.org/10.1680/jphmg.20.00006>
- Rault G., Thorel L., Néel A., Buttigieg S., Derckx F., Six G., Okyay U., 2010. Mobile tray for simulation of 3D load transfer in pile-supported earth platforms. *7th ICPMG* June 28th- July 1st, Zurich, Springman, Laue & Seward (eds) Taylor & Francis Group, London, ISBN 978-0-415-59288-8, pp.261-266.
- Rousset J.M., Thorel L., 2018. *Liquefaction. Final report for ECN and Ifsttar (in French)*. 63p.
- Saade C. Li Z., Escoffier S., Thorel L., 2022. Evaluation of boundary effects in centrifugal tests subjected to seismic loading by numerical modelling (in French). *J. Nat. Geotech. Geol. Ing., JNGG2022*, Lyon. 492-499. <https://jngg2022.sciencesconf.org/372608>
- Schiavon J.A., Tsuha C.H.C., Neel A., Thorel L., 2019. Centrifuge modelling of a helical anchor under different cyclic loading conditions in sand. *Int. J. Phys. Mod. Geotech.* <https://doi.org/10.1680/jphmg.17.00054>, 19(2): 72-88
- Schiavon J.A., Tsuha C.H.C., Thorel L., 2016. Scale effect in centrifuge tests of helical anchors in sand *Int. J. Physical Modelling in Geotechnics*, vol.16(4), 185-196. <http://doi.org/10.1680/jphmg.15.00047>
- Schiavon J.A., Tsuha C.H.C., Thorel L., 2017. Cyclic and post-cyclic monotonic response of a single-helix anchor in sand. *Geotech. Lett.* 7, 11-17, <http://doi.org/10.1680/jgele.16.00100>
- Springman S., Laue J., Seward L., 2010. Physical modelling in Geotechnics. *7th ICPMG*, June 28th- July 1st, Zurich, Springman, Laue & Seward (eds) Taylor & Francis Group, London, ISBN 978-0-415-59288-8, 1495p.
- Stratasys, 2022. <https://www.stratasys.com/explore/blog/2020/3d-printing-faq> (accessed on 13/01/2022)
- Tang A.M., Yavari N., Nguyen V.T., Pereira J.-M., Hasse G., 2021. Physical modeling of the thermo-mechanical behavior of a geothermal pile. *Rev. fr. Geotech.*, 166. <https://doi.org/10.1051/geotech/2021004>
- Thorel L., Audrain Ph., Neel A., Bretschneider A., Blanc M., 2017. Centrifuge rolling test for ore liquefaction analysis. *VII Int. Conf. Comput. Meth. Marine Engng MARINE 2017* M. Visonneau, P. Queutey and D. Le Touzé (Eds), Nantes 15-17 may. pp.290-295.
- Thorel L., El Haffar I., Maatouk S., Schiavon J.A., Tsuha C., 2020. Cyclic loading of helical pile as anchor for floating wind turbine: centrifuge tests. *ISFOG2020*, Austin. Postponed to 8-11nov 2021. 313-320. article #3442 <http://www.dfi.org/publications.asp?cl=1069>
- Thorel L., Estaire J., Muraro S., Wang H., Quinten T., Askarnejad A., Li Z., 2022. *New materials, new sensing and new manufacturing methods*. Report D09.03, GEOLAB project. 62p. <https://kp.project-geolab.eu/joint-research-activities/>
- Thorel L., Garnier J. 2002. *High-g modelling*. 19min video, LCPC.
- Thorel L., Jenck O., 2021. Physical modelling in geotechnics, 1st part (in French). *Rev. Fr. Geotech.*, 166. <https://doi.org/10.1051/geotech/2021002>
- Thorel L., Saboya F., Audrain Ph., Neel A., Bretschneider, Blanc M., 2018. Rolling Test in Geotechnical Centrifuge for Ore Liquefaction Analysis. *9th ICPMG London* 17-20th July. Physical Modelling in Geotechnics – McNamara et al. (Eds) Taylor & Francis Group, ISBN 978-1-138-34419-8, pp465-468.
- Tsuha C.H.C., Aoki N., Rault G., Thorel L., Garnier J., 2007. Physical modelling of helical pile anchors. *Int. J. Physical Modelling in Geotechnics*, vol.7, n°4, pp1-12. doi.org/10.1680/jphmg.2007.070401
- Tsuha C.H.C., Aoki N., Rault G., Thorel L., Garnier J., 2012. Evaluation of the efficiencies of helical anchor plates in sand by centrifuge model tests. *Can. Geotech. J.* 49 (9), pp.1102-1114 <https://doi.org/10.1139/t2012-064> correction: Canadian Geotechnical Journal 57 (5), 783-783. <https://doi.org/10.1139/cgj-2020-0196>
- Vaschy A., 1892. On the laws of similarity in physics (in french). *Annales télégraphiques*, 19, 25-28.
- Yavari N., Tang A.M., Pereira J.M., Hassen G., 2014. Experimental study on the mechanical behavior of a heat exchanger pile using physical modelling. *Acta Geotechnica* 9, 385-398. <https://doi.org/10.1007/s11440-014-0310-7>
- Yuan B., Sun M., Xiong L., Luo Q., Pradhan SP, Li H., 2020. Investigation of 3D deformation of transparent soil around a laterally loaded pile based on a hydraulic gradient model. *J. Build. Engng*, 28, <https://doi.org/10.1016/j.job.2019.101024>
- Zelikson A., 1969. Geotechnical models using the hydraulic gradient similarity method. *Géotechnique* 19, n°4, 495-508. <https://doi.org/10.1680/geot.1969.19.4.495>