



HAL
open science

A Spectrum-based Filter Design for Periodic Output Regulation of Systems with Dead-Time

Can Kutlu Yuksel, Tomáš Vyhlídal, Silviu-Iulian Niculescu

► **To cite this version:**

Can Kutlu Yuksel, Tomáš Vyhlídal, Silviu-Iulian Niculescu. A Spectrum-based Filter Design for Periodic Output Regulation of Systems with Dead-Time. 22nd World Congress of the International Federation of Automatic Control (IFAC 2023), Jul 2023, Yokohama, Japan. 10.1016/j.ifacol.2023.10.1682 . hal-04071852

HAL Id: hal-04071852

<https://hal.science/hal-04071852>

Submitted on 17 Apr 2023

HAL is a multi-disciplinary open access archive for the deposit and dissemination of scientific research documents, whether they are published or not. The documents may come from teaching and research institutions in France or abroad, or from public or private research centers.

L'archive ouverte pluridisciplinaire **HAL**, est destinée au dépôt et à la diffusion de documents scientifiques de niveau recherche, publiés ou non, émanant des établissements d'enseignement et de recherche français ou étrangers, des laboratoires publics ou privés.

A Spectrum-based Filter Design for Periodic Output Regulation of Systems with Dead-Time [★]

Can Kutlu Yuksel^{*,**} Silviu-Iulian Niculescu^{**}
Tomáš Vyhliřal^{*}

^{*} *Department of Instrumentation and Control Engineering, Faculty of Mechanical Engineering, Czech Technical University in Prague, Technická 4, Prague 6, 16607, Czechia.*

^{**} *Université Paris-Saclay, CNRS, CentraleSupélec, Inria, Laboratoire des Signaux et Systèmes (L2S), 91192 Gif-sur-Yvette, France*

Abstract:

This paper presents a filter structure that allows the user to place desired poles and the necessary zeros to achieve periodic regulation to the closed-loop sensitivity through Internal Model Control framework. The periodic regulation is aimed at stable SISO linear systems suffering from input dead-time and having no closed right-half plane zeros. The negative effects of the dead time on tracking/rejection are compensated by introducing another delay which is tuned independently from the filter thanks to its structure. The main focus is given to constructing the filter with polynomials. However, it can be readily extended to quasi-polynomials. The findings are verified with a computer simulation of a vibration control task.

Keywords: delay; filter design; IMC; vibration control.

1. INTRODUCTION

Periodic output regulation aims to ensure that the particular system under control performs in the desired manner when subjected to periodic exogenous signals. If this exogenous signal is received from the reference, the controller's objective becomes to follow the reference without lag or imperfection. If the signal acts on the system output as a disturbance, then the goal is also to cancel the effects caused by this disturbance. From a systems theory perspective, these two goals are identical and the celebrated Internal Model Principle (IMP) stated by Francis and Wonham (1976) forms a roadmap to achieve them.

The IMP states that perfect tracking/rejection of a signal can be achieved when the close-loop control system encapsulates a model of the signal and is guaranteed to be stable. This translates to placing the poles of the signal model as the zeros of a stable sensitivity function and hence the perfect tracking/rejection. The renowned *repetitive control* strategy for periodic regulation, introduced in Inoue et al. (1981), is a particular realization of this principle derived by employing a time-delay model of the periodic signal expressed by the transfer function

$$G_{signal}(s) = \frac{1}{1 - F(s)e^{-sT_d}}, \quad (1)$$

where $F(s)$ is a low-pass filter and T_d is the period of the signal. It is easy to observe that the ideal model that captures every possible signal with period T_d is achieved when $F(s) = 1$. However, employing such a model leads to a closed-loop sensitivity whose dynamics can be described by delay-differential equations of neutral type, and, as shown in Hara et al. (1988), is only BIBO stabilizable for systems with relative degree zero. Therefore, with the expense of a degraded signal model, the associated low-pass filter, with sufficient bandwidth, is utilized to make the overall setup applicable to (strictly) proper systems with achievable stability. As expected, the degradation in the signal model is due to the fact that the filter alters the ideal harmonic pole distribution. In such a case, the filter bandwidth is what determines the number of finitely targeted harmonic poles; those harmonic frequencies that lie outside the bandwidth diverge from their ideal position drastically.

Inspired by this approach, there have been many generalizations or alternatives of the signal model (1) for reasons to improve the transient performance, robustness, and applicability of the strategy to more sophisticated systems. Among these, one particular generalization is obtained by replacing the lumped delay e^{-sT_d} with an exponential polynomial over \mathbb{R} , as in

$$G_{signal}(s) = \frac{1}{1 - F(s)W(s)}, \quad (2)$$

where $W(s) = \sum_{i=1}^m w_i e^{-msT_d}$ with $w_i \in \mathbb{R}$. Such configurations with model (2) have been referred to as the

[★] This work was supported by the Czech Science Foundation project No. 21-07321S - *Persistent problems of repetitive control*. The work of the first and second authors was also supported by a public grant overseen by the French National research Agency (ANR) as part of the Investissements d'Avenir program, through the "ADI 2020" project funded by the IDEX Paris-Saclay, ANR-11-IDEX-0003-02. The first author was also supported by the Student Grant Agency of the Czech Technical University in Prague, student grant No. SGS23/157/OHK2/3T/12.

high-order repetitive control, and tuning of the weights w_i to improve performance and robustness was studied in Inoue (1990); Chang et al. (1995); Steinbuch et al. (2007); Pipeleers et al. (2008) mainly for discrete-time systems. Model (2) is of particular interest because it marks an important observation: despite the known negative impacts of delays on system stability, the presence of more delays in the model can lead to greater flexibility to optimize with respect to a desired property. Intuitively, the increased capability for further improvement can be reasoned by the fact that model (2) describes a signal based on multiple past values in contrast to Model (1) where only one past information is utilized. With similar motivation, an alternative transport equation representation of the signal was proposed in Astolfi et al. (2021).

Nevertheless, all these signal models can prove their functionality only if the closed-loop system is stable, and it is a known fact that such a property can be easily lost due to uncounted additional delays that can occur in the loop through true or approximation of the controlled system. Thankfully, many notions of stability analysis for finite dimensional systems, mainly eigenvalue-based and Lyapunov-based approaches, carry over to infinite dimensional systems under which many time-delay systems are categorized.

This paper proposes a controller design that can simultaneously achieve periodic regulation and input-delay compensation as in Vyhlídal and Zitek (2001); Yuksel et al. (2021a,b). The design steps for periodic regulation differ from the approach seen in repetitive control: rather than a time-delay signal model, a model of the system is employed in the loop, and the required zeros for regulation are introduced one by one to the sensitivity with a special filter in contrast to first placing infinitely many zeros through the signal model and then drastically drifting them away from the imaginary axis except those which are of interest. The proposed individual treatment of zeros ensures the harmonic zeros to stay on the imaginary axis and prevents unwanted zeros from occurring between targeted frequencies. Other features of the design are that it does not require the system model to be of first-order as was the case in the previous works of the authors, and the controller is derived directly from a reference sensitivity that specifies the desired spectrum. Therefore, stability is assured from the very beginning for the ideal case, and furthermore, all possible controllers fulfilling the demands are parameterized by the location of the stable poles of the sensitivity. Clearly, having controllers meeting the demands parameterized makes the approach suitable for optimization, though discussion on this topic is not in the scope of the paper, and only some remarks are given in the subsequent sections.

The aim of the paper is to introduce the reader to a straightforward yet effective design concept and to contribute to the previous works of the authors. It is organized in the following manner: Section 2 covers the controller design and introduces the Internal Model Control scheme, which forms the framework for the design. The section also elaborates on the conditions that need to be satisfied by the filter within the controller and the additional delay for regulation/compensation and proceeds to the state-space formulation due to the convenience it brings to implement

and impose the conditions. Section 3 gives remarks about the proposed controller, including the generalization of the filter via quasi-polynomials and methods to improve the performance of the control system to delay variations. Section 4 numerically validates the effectiveness of the controller structure introduced in Section 2 via a simulation of a vibration control applied to a fourth-order system with input delay. Finally, the paper is concluded with Section 5.

2. CONTROLLER DESIGN

The controller design begins by specifying a stable sensitivity with the desired zeros for periodic regulation and deduces the controller structure and the conditions based on Internal Model Control scheme.

We consider a stable SISO plant $G(s)$ of the form

$$G(s) = \frac{Y(s)}{U(s)} = \frac{s^\alpha + a_{\alpha-1}s^{\alpha-1} + \dots + a_1s + a_0}{b_\beta s^\beta + b_{\beta-1}s^{\beta-1} + \dots + b_1s + b_0} e^{-s\tau_p}, \quad (3)$$

where the polynomials in the numerator and the denominator are Hurwitz with $\beta \geq \alpha$ and $\tau_p > 0$.

The exogenous signal $v(t)$ to be ideally tracked/rejected is assumed to have a finite Fourier series expansion i.e.

$$v(t) = v_0 + \sum_{i=-k}^k v_i e^{j\omega_i t}, \quad (4)$$

where frequencies ω_i are commensurate i.e. integer multiples of a base frequency ω_b , v_i is the corresponding Fourier coefficient and $k \in \mathbb{N} \setminus \{\infty\}$. In accordance with IMP, this implies that the sensitivity transfer function $S(s)$ of the closed-loop needs to be stable and have zeros at $s = 0$ and $s = \pm j\omega_i$ for $i = 1, \dots, k$ i.e.

$$S(s) = \frac{z(s)}{p(s)}, \quad (5)$$

where $z(s)$ and $p(s)$ are the numerator and denominator of the sensitivity, respectively, and such that $z(0) = z(j\omega_i) = 0$ and $p(s)$ is Hurwitz.

More specifically, if $z(s)$ and $p(s)$ happen to be polynomials, the desired sensitivity has the form

$$S(s) = \frac{s \prod_{i=1}^k (s^2 + \omega_i^2) \prod_m (s - z_m)}{\prod_n (s - p_n)}, \quad (6)$$

where $p_n \in \mathbb{C}^-$ and z_m denote the poles and the additional zeros, respectively.

2.1 Internal Model Control

Internal Model Control (IMC) is the control arrangement depicted in Figure 1, in which the model of the controlled plant is employed in the control loop to compare the actual output of the plant with the estimated one. The features of the IMC scheme were extensively studied by Garcia and Morari (1982). Further adaptive extensions of this scheme was proposed in Hahn et al. (2002) for delay compensation. A robust filter-based IMC design for

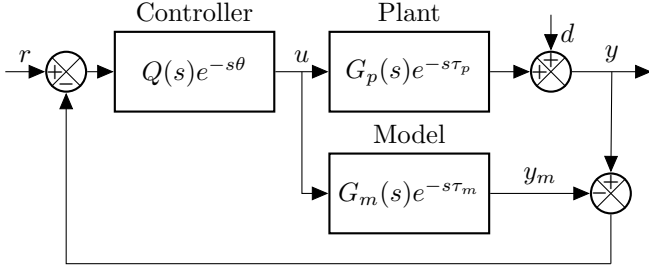

Fig. 1. The internal model control scheme

removing periodic disturbance from systems approximated by first-order models with dead-time was proposed by Vyhldal and Zitek (2001) and Yuksel et al. (2021a).

The *sensitivity transfer function* $S(s)$ of the IMC scheme in Fig. 1 is given by

$$S(s) = \frac{1 - Q(s)G_m(s)e^{-s(\tau_m+\theta)}}{1 + Q(s)(G_p(s)e^{-s(\tau_p+\theta)} - G_m(s)e^{-s(\tau_m+\theta)})}, \quad (7)$$

and it is a retarded time-delay system with infinitely many zeros and poles. Assuming that the *ideal case* holds i.e. $G_p(s) = G_m(s) = G(s)$ and $\tau_p = \tau_m = \tau$, it reduces to

$$S(s) = 1 - Q(s)G_m(s)e^{-s(\tau_m+\theta)}. \quad (8)$$

Based on the proposed design by Vyhldal and Zitek (2001), if the controller structure is constructed as

$$Q(s) = \frac{1}{G_m(s)}F(s), \quad (9)$$

where $F(s)$ is a low-pass filter, then reflecting this to the ideal sensitivity in Equation (8) yields

$$S(s) = 1 - F(s)e^{-s(\tau+\theta)}, \quad (10)$$

Notice that, the inverse of $G_m(s)$ can be utilized in (9) thanks to having no non-minimum phase zeros. The delay θ associated with the controller $Q(s)$ is used to compensate for the negative effects of the other delay. Imposing the conditions on zeros of the sensitivity given by (5) and studying Equation (10) in terms of its modulus and argument yield the conditions need to be satisfied by $F(s)$ and θ :

$$\lim_{s \rightarrow 0} F(s) = 1 \quad (11)$$

$$|F(j\omega_i)| = 1 \quad (12)$$

$$\angle F(j\omega_i) - \omega_i(\tau + \theta) = 2\pi h \quad (13)$$

where $h \in \mathbb{Z}$.

2.2 Ideal Filter Structure

Suppose initially that there are no delays in the loop, i.e. $\tau = \theta = 0$. Then based on Equation (10), the filter that results in the desired reference sensitivity expressed via (5) can be found as

$$F(s) = \frac{p(s) - z(s)}{p(s)}, \quad (14)$$

which is referred to as the *ideal filter*. Notice that, it satisfies condition (11)-(12) and has no phase shift at $\omega = \omega_i$ i.e. $\angle F(j\omega_i) = 0$ since

$$F(j\omega_i) = \frac{p(j\omega_i) - z(j\omega_i)}{p(j\omega_i)} = \frac{p(j\omega_i)}{p(j\omega_i)} = 1. \quad (15)$$

However, in order to make the controller $Q(s)$ proper, the filter needs to be proper with a relative degree $n_r \geq \beta - \alpha$. Throughout the paper, we consider filters that are strictly proper i.e. $n_r \neq 0$, for being generally applicable to all systems expressed by (3). For a filter to be strictly proper, the terms with the highest power from $p(s)$ and $z(s)$ must match. Hence, if the filter is derived through a sensitivity based on monic polynomials as in (6) then the condition

$$n = 2k + m + 1 \quad (16)$$

must hold. Notice that, for each introduced additional zeros, we need to place one additional stable pole and vice versa.

2.3 State-Space Formulation

Even though the transfer function representation of the ideal filter is straightforward, its direct implementation is likely to lead to numerical problems. To overcome this issue for filters with polynomials, the sensitivity and, later on, the filter is expressed in a state-space form, which allows employing numerically more reliable methods. In addition, the conditions to achieve desired relative degree for the filter can be posed as linear constraints, which can subsequently be used to solve for the unknown system matrices.

Let $[A, B, C, D]$ denote the standard matrices of the state-space representation of the sensitivity (6). Then from (14), it simply follows that the filter is $[A, B, -C, (1 - D)]$.

The system matrix A is such that its characteristic equation corresponds to $p(s)$ i.e. $\det(\lambda I - A) = p(s)$. Without loss of generality, set $C = [1 \ 1 \ \dots \ 1]_{1 \times n}$ and $D = 1$. The harmonic zeros $z_\omega \in \{-j\omega_k, \dots, 0, \dots, j\omega_k\}$ of the sensitivity must satisfy

$$C(z_\omega I - A)^{-1}B = -D, \quad (17)$$

which gives $2k + 1$ equation:

$$\begin{bmatrix} CA^{-1} \\ \Re(C(j\omega_1 I - A)^{-1}) \\ \Im(C(j\omega_1 I - A)^{-1}) \\ \vdots \\ \Re(C(j\omega_k I - A)^{-1}) \\ \Im(C(j\omega_k I - A)^{-1}) \end{bmatrix} B_{n \times 1} = \begin{bmatrix} -D \\ -D \\ 0 \\ \vdots \\ -D \\ 0 \end{bmatrix} \quad (18)$$

The other $n - 2k - 1$ equations required to have a solution for B come from the conditions for the relative degree. Notice that the required number of equations is equal to the number of additional zeros m . It can be shown that the relative degree of the filter in state space form can be determined by the number of the terms of the sequence $((1 - D), -CB, -CAB, -CA^2B, \dots)$ that are equal to zero starting from the first one. The first term happens to be zero thanks to setting $D = 1$, therefore the filter is at least of relative degree one. For $n_r \geq 2$, the following set of equations must be satisfied:

$$\begin{bmatrix} C \\ CA \\ \vdots \\ CA^{(n_r-2)} \end{bmatrix} B = \begin{bmatrix} 0 \\ 0 \\ \vdots \\ 0 \end{bmatrix} \quad (19)$$

Hence, the relationship between the number of additional zeros and the relative filter order corresponds to

$$m = n_r - 1. \quad (20)$$

Combining Equations (18) and (19) gives in total n equations from which B can be uniquely found.

Subsequently, the inverse model dynamics is added to the filter to give the state space model of the controller $Q(s)$:

$$A_Q = \tilde{A} = \begin{bmatrix} A & 0 \\ -B_\alpha C & A_\alpha \end{bmatrix} \quad (21)$$

$$B_Q = \tilde{B} = \begin{bmatrix} B \\ 0 \end{bmatrix} \quad (22)$$

$$C_Q = [b_\beta \ b_{\beta-1} \ \dots \ b_1 \ b_0] \begin{bmatrix} \tilde{C}\tilde{A}^\beta \\ \tilde{C}\tilde{A}^{\beta-1} \\ \vdots \\ \tilde{C} \end{bmatrix} \quad (23)$$

$$D_Q = b_\beta \tilde{C}\tilde{A}^{(\beta-1)}\tilde{B} \quad (24)$$

where $[A_\alpha, B_\alpha, C_\alpha, D_\alpha]$ is a minimal state-space realization of $G_\alpha(s) = (s^\alpha + a_{\alpha-1}s^{\alpha-1} + \dots + a_1s + a_0)^{-1}$ and $\tilde{C} = [-D_\alpha C \ C_\alpha]$. Note that, $[\tilde{A}, \tilde{B}, \tilde{C}, 0]$ is obtained when the filter is combined with $G_\alpha(s)$ and it has a relative order not less than β . Using this fact yields the controller.

2.4 Delay Adjustment

Compensation for the negative effects of system delay τ on periodic tracking/rejection is achieved by tuning the user-definable delay θ to satisfy the argument condition (13). Since the phase-shift induced by the filter (14) is zero at harmonic frequencies, the condition reduces to

$$\omega_i(\tau + \theta) = 2\pi l, \quad (25)$$

where $l = -h$. The assumption that all frequencies ω_i are commensurate implies that there exists a frequency, so-called the *base frequency* ω_b , such that $\omega_b \leq \omega_i$ and $\frac{\omega_i}{\omega_b} = \gamma \in \mathbb{Z}$. Utilizing this base frequency yields an equation for the smallest θ satisfying (25) which is valid for all frequencies ω_i :

$$\theta = \frac{2l_b\pi}{\omega_b} - \tau \geq 0, \quad (26)$$

where $l_b = \left\lceil \frac{\tau\omega_b}{2\pi} \right\rceil + 1$. Note that, if $\omega_b(\tau + \theta)$ is an integer multiple of 2π then so as $\omega_i(\tau + \theta) = \gamma\omega_b(\tau + \theta)$.

It is clear from Equation (8) that the resulting sensitivity in the presence of delays is different than the sensitivity taken as a reference to form the ideal filter. In fact, it attains infinitely many zeros since the numerator corresponds to a quasi-polynomial. However, when θ is chosen according to Equation (26) the resulting sensitivity encapsulates the harmonic zeros from the reference sensitivity and has identical poles.

3. FURTHER REMARKS

To this point, the only condition on the poles has been for them to lie on the left half plane of the complex space. Even though this is sufficient to guarantee the stability of the close loop for the ideal case, the real-life application of the controller requires the close-loop to be robust to inevitable mismatches between the plant and the model. Furthermore, not every pole distribution leads to a desirable response performance. For this reason, the placing of the poles must be carried out with respect to a chosen robustness and/or performance measure, such as the H_∞ -norm of the sensitivity. Such an operation can be done either analytically or numerically by posing an optimization problem. However, in doing so, one must make sure that the computations comply with the nature of time-delay systems. For instance, a method to compute the H_∞ norm of SISO time-delay systems was proposed by Gumussoy and Michiels (2015).

The proposed filter is also suitable for applying delay adaptive methods thanks to Equation (25). For instance, a wavelet-based algorithm for θ to compensate for varying plant delays was recently proposed in Peichl et al. (2022).

Additionally, the filter does not necessarily have to consist of polynomials. In fact, if the utilization of quasi-polynomials is permitted, one can attain dynamics otherwise not achievable and can lower the order of the overall filter. For instance, the distributed delay approach studied by Yuksel et al. (2021b) for first-order systems with input-delay, corresponds to choosing $z(s)$ to be the quasi-polynomial of the form

$$z(s) = s - \sum_k a_k e^{-s\theta_k}, \quad (27)$$

with $p(s) = s$. The zeros are placed by tuning the coefficients a_k associated with fixed delays. Such configuration was shown to lead to a pole-less sensitivity which made the response dynamics governed by a difference equation.

4. ILLUSTRATIVE EXAMPLE

The proposed controller model is tested on a computer simulation of a fourth-order model corresponding to the serially connected mass-spring-damper with two actuators depicted in Figure 2 where $m_1 = 1.1$ kg, $m_2 = 0.514$ kg, $k_1 = 1768$ N m⁻¹, $k_2 = 424$ N m⁻¹, $c_1 = 4.43$ N s m⁻¹, $c_2 = 2.41$ N s m⁻¹ and is described by,

$$m_1\ddot{x}_1(t) + (c_1 + c_2)\dot{x}_1(t) + (k_1 + k_2)x_1(t) = c_2\dot{x}_2(t) + k_2x_2(t) + u(t - \tau) - d(t), \quad (28)$$

$$m_2\ddot{x}_2(t) + c_2\dot{x}_2(t) + k_2x_2(t) = c_2\dot{x}_1(t) + k_2x_1(t) + d(t). \quad (29)$$

The goal is to control the position of mass m_1 by actuator u with output feedback despite the oscillations caused by actuator d and artificially added input delay of $\tau=0.2$ s. The position response of mass m_1 to a unit step from input u is as shown in Figure 3.

The disturbance is caused by forcing the masses in a sawtooth manner with frequency $f_d = 2$ Hz, resulting in m_1 being exposed to oscillations with spectrum shown in Figure 4.

The controller is designed to cancel the first 8 harmonics of the disturbance and contains an all-polynomial filter

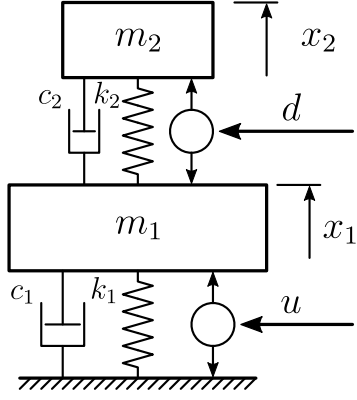

Fig. 2. Diagram of the controlled system

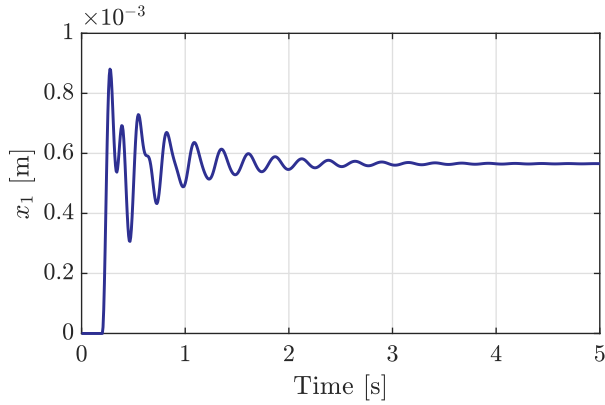

Fig. 3. Response of m_1 to a unit step input from u initiated at $t = 0s$. Notice that the effect of the added input-delay $\tau = 0.2s$ is visible in the beginning.

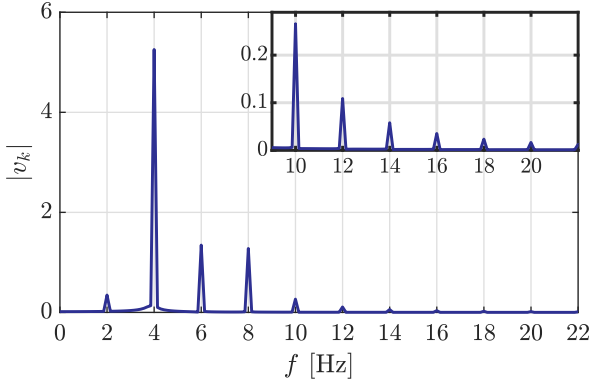

Fig. 4. Spectrum of the acting disturbance on m_1 .

with a relative order $n_r = 5$, which is achieved by placing $m = 4$ additional zeros. Hence, the order of the reference sensitivity becomes $n = 2 \times 8 + 4 + 1 = 21$. The placing of the poles is chosen to make 16 of them close to the harmonic zeros, and the rest to lie on the real axis. The compensation for input delay is achieved by setting $\theta = 0.3s$ since $\omega_b = 12.56$ [rad/s].

Figure 5 shows the Bode magnitude plot of the resulting ideal sensitivity in the form (10) with filter (14). It is clear from the figure that the chosen pole distribution gives a favorable $\|S(j\omega)\|_\infty < 2$ for robustness.

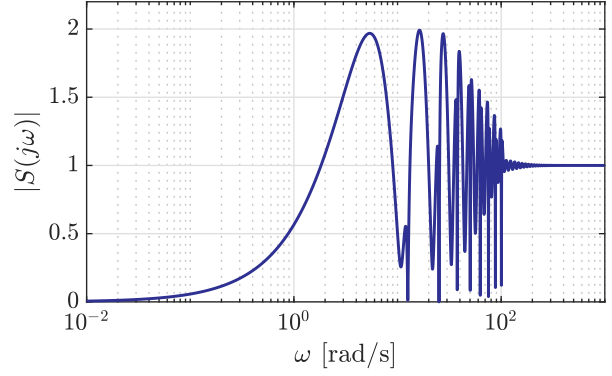

Fig. 5. Bode Magnitude Plot of the Resulting Sensitivity

Figure 6 shows the pole-zero distribution, obtained via QPmR by Vyhlidal and Zitek (2009), of the ideal sensitivity $S(s)$ and the non-ideal sensitivity $S_{per}(s)$ of the form (7) with the system subjected to the perturbation, $G_p(s) = \frac{0.9}{0.05s+1}G_m(s)$. As can be seen, the harmonic zeros are placed and preserved, and the close loop remains stable despite the perturbation. Note that, in the ideal case, the close-loop has infinitely many zeros but finitely many poles. However, in the non-ideal case, both the zeros and the poles form chains that tend to each other at infinity. Notice also that, after perturbation, the poles moved dangerously close to the imaginary axis.

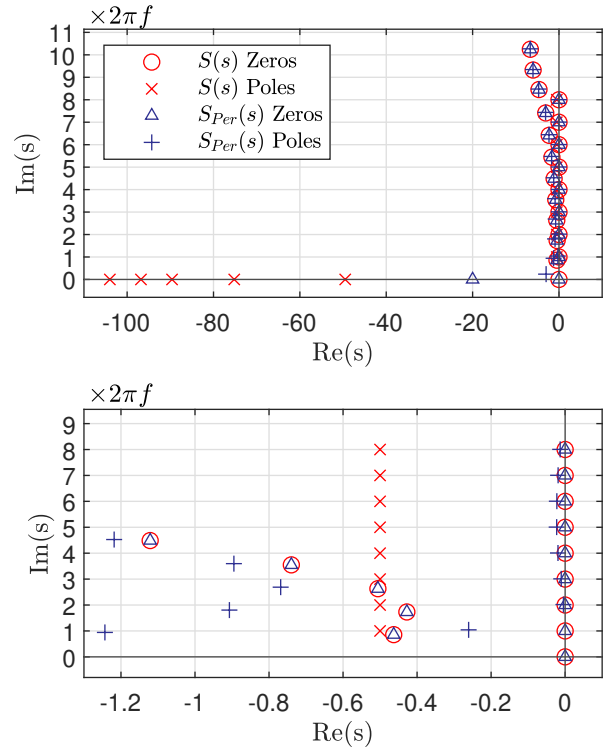

Fig. 6. Pole Zero Distribution of the ideal sensitivity $S(s)$ of the form (6) and the perturbed sensitivity $S_{per}(s)$ of the form (7) (**Top**) Overall spectrum of $S(s)$ and $S_{per}(s)$ (**Bottom**) Zoomed view showing the placed harmonic zeros.

The transient rejection and tracking performance of the ideal control system are demonstrated in Figures 7 and

8, respectively. The filter has a relatively slow rejection performance with residual oscillation caused by the unaccounted higher harmonics and a relatively fast tracking performance with undesirable spiky behavior, indicating the necessity of further optimization for the pole locations.

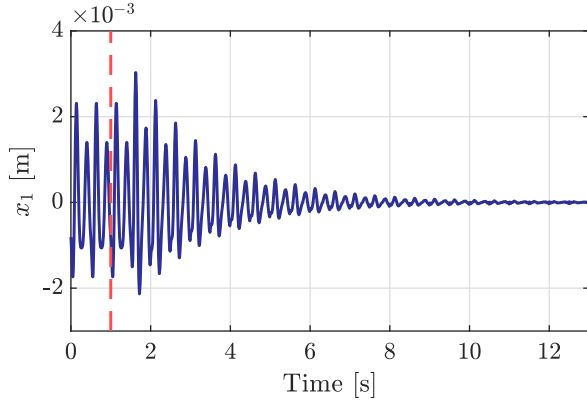

Fig. 7. Disturbance rejection performance of the proposed controller with specified poles. The activation moment $t = 1$ s of the controller is indicated by the vertical dashed line.

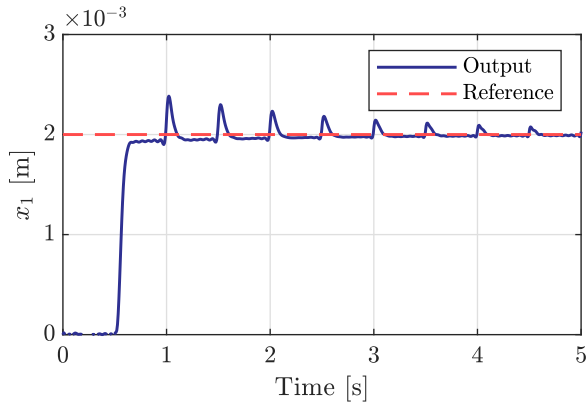

Fig. 8. Reference tracking performance of the proposed controller under simultaneously suppressed disturbance. The step reference is given at $t = 0$ s. Notice the increased delay in response compared to the response in Figure 3 due to $\theta + \tau$.

5. CONCLUSION

Alternative to the repetitive control, an analytical design method is proposed to derive a controller that can achieve both periodic regulation and input time-delay compensation for stable systems with dead-time and no closed right-half plane zeros. The controller design does not necessarily require a first-order model approximation of the plant, as it was the case in the authors' previous works. This is achieved by utilizing the so-called *ideal filter* in the IMC framework. The filter poles ensure the stability of the close-loop. Nevertheless, the decision on the pole locations is an open question. Additionally, the proposed filter structure can be further extended with quasi-polynomials, forming a new perspective for employing delays in the control loop. Future works will focus on this together with experimentation and the placing of poles with respect to a performance/robustness measure.

REFERENCES

- Astolfi, D., Marx, S., and van de Wouw, N. (2021). Repetitive control design based on forwarding for nonlinear minimum-phase systems. *Automatica*, 129, 109671.
- Chang, W.S., Suh, I.H., and Kim, T.W. (1995). Analysis and design of two types of digital repetitive control systems. *Automatica*, 31(5), 741–746.
- Francis, B.A. and Wonham, W.M. (1976). The internal model principle of control theory. *Automatica*, 12(5), 457–465.
- Garcia, C.E. and Morari, M. (1982). Internal model control: a unifying review and some new results. *Industrial & Engineering Chemistry Process Design and Development*, 21(2), 308–323.
- Gumussoy, S. and Michiels, W. (2015). Computation of extremum singular values and the strong h-infinity norm of siso time-delay systems. *Automatica*, 54, 266–271.
- Hahn, J., Edison, T., and Edgar, T.F. (2002). Adaptive imc control for drug infusion for biological systems. *Control Engineering Practice*, 10(1), 45–56.
- Hara, S., Yamamoto, Y., Omata, T., and Nakano, M. (1988). Repetitive control system: A new type servo system for periodic exogenous signals. *IEEE Transactions on automatic control*, 33(7), 659–668.
- Inoue, T. (1990). Practical repetitive control system design. In *29th IEEE Conference on Decision and Control*, 1673–1678. IEEE.
- Inoue, T., Nakano, M., Kubo, T., Matsumoto, S., and Baba, H. (1981). High accuracy control of a proton synchrotron magnet power supply. *IFAC Proceedings Volumes*, 14(2), 3137–3142.
- Peichl, A., Kuchar, M., Yuksel, C.K., Niculescu, S.I., and Vyhlidal, T. (2022). Two-harmonic periodic disturbance compensation for dead-time processes with online identification of input delay. In *17th IFAC Workshop on Time Delay Systems*.
- Pipeleers, G., Demeulenaere, B., De Schutter, J., and Swevers, J. (2008). Robust high-order repetitive control: Optimal performance trade-offs. *Automatica*, 44(10), 2628–2634.
- Steinbuch, M., Weiland, S., and Singh, T. (2007). Design of noise and period-time robust high-order repetitive control, with application to optical storage. *Automatica*, 43(12), 2086–2095.
- Vyhlidal, T. and Zitek, P. (2001). Control system design based on a universal first order model with time delays. *Acta Polytechnica*, 41(4-5).
- Vyhlidal, T. and Zitek, P. (2009). Mapping based algorithm for large-scale computation of quasi-polynomial zeros. *IEEE Transactions on Automatic Control*, 54(1), 171–177.
- Yuksel, C.K., Busek, J., Niculescu, S.I., and Vyhlidal, T. (2021a). Internal model controller to attenuate periodic disturbance of a first-order time-delay system. In *2021 European Control Conference (ECC)*, 81–86. IEEE.
- Yuksel, C.K., Busek, J., Vyhlidal, T., Niculescu, S.I., and Hromcik, M. (2021b). Internal model control with distributed-delay-compensator to attenuate multi-harmonic periodic disturbance of time-delay system. In *2021 60th IEEE Conference on Decision and Control (CDC)*, 5477–5483. IEEE.