



HAL
open science

Recycling of TBM-Excavated Materials of the Paris Basin into Technosol: A Numerical Assessment of Its Hydrological Transfer Functions

Ghada Snoussi, Yijue Yang, Imen Bel Hadj Ali, Essaieb Hamdi, Olivier Fouché

► **To cite this version:**

Ghada Snoussi, Yijue Yang, Imen Bel Hadj Ali, Essaieb Hamdi, Olivier Fouché. Recycling of TBM-Excavated Materials of the Paris Basin into Technosol: A Numerical Assessment of Its Hydrological Transfer Functions. *Advances in Hydroinformatics. SimHydro 2019 - Models for Extreme Situations and Crisis Management*, Gourbesville P., Caignaert G. (eds), Jun 2019, Nice, France. pp.1063-1077, 10.1007/978-981-15-5436-0_80 . hal-04063333

HAL Id: hal-04063333

<https://hal.science/hal-04063333>

Submitted on 6 Jun 2023

HAL is a multi-disciplinary open access archive for the deposit and dissemination of scientific research documents, whether they are published or not. The documents may come from teaching and research institutions in France or abroad, or from public or private research centers.

L'archive ouverte pluridisciplinaire **HAL**, est destinée au dépôt et à la diffusion de documents scientifiques de niveau recherche, publiés ou non, émanant des établissements d'enseignement et de recherche français ou étrangers, des laboratoires publics ou privés.

RECYCLING OF TBM-EXCAVATED MATERIALS OF THE PARIS BASIN INTO TECHNOSOL: A NUMERICAL ASSESSMENT OF ITS HYDROLOGICAL TRANSFER FUNCTIONS

Ghada, Snoussi *, gsnoussi@yahoo.fr

Yijue, Yang **, hyangyijue@hotmail.com

Imen, Bel Hadj Ali *, belhadjaliimen@gmail.com

Essaieb, Hamdi *, essaieb@yahoo.fr

Olivier, Fouché ^{1**}, olivier.fouche-grobla@lecnam.net

^{*}Ecole nationale d'ingénieurs de Tunis, BP 37, 1002 Tunis Belvédère, Tunisie

^{**}Conservatoire national des arts et métiers, Cnam, 2 rue Conté, 75003 Paris, France

KEY WORDS

Tunnel boring machine (TBM), Excavated materials, Technosol, Anthroposol, Urban microclimate, COMSOL software, Unsaturated soil, Infiltration, Heat transfer, Porous media.

ABSTRACT

The new face of Paris will emerge by the Grand Paris Express, a new mass transit network as part of the broader Grand Paris urban renewal and agglomeration initiative. However, this project will generate more than 45 million tons of excavated materials, still legally considered as wastes. This study is based on a scientific solution suggested for recycling those geological materials which will be excavated mainly by tunnel boring machines. The concept is to transform them into new soil called "Technosol" in the World Reference Base for soil Resources or "Anthroposol" in the French Pedology Referential. With a dedicated mode of implementation, those technosols should have interesting hydraulic, thermal, geotechnical and pedological properties. Technosols will allow to revegetate and minimize heat island effect and flooding hazard in urban areas, and this will bring new life to the urban ecosystem. In this study, to explore some properties of a patented technosol, COMSOL Multiphysics software is used to couple a soil hydraulic model with a thermal model of a porous medium in unsaturated state. The main result of running transfer functions through "dry" soil is production of realistic initial conditions of temperature and humidity profiles. Knowing these initial conditions and ensuring numerical stability of the model are requested for future hydrological simulations (runoff, infiltration, recharge of the saturated zone) with real material, rainfall and atmospheric temperature data.

1. INTRODUCTION

In Paris 2030, the main urban megaproject in Europe must take place: "Grand Paris Express" is the future network of more than 200 km automatic subway lines (90% underground) which shall provide much needed infrastructure to the peripheral suburbs of Paris. According to the Société du Grand Paris, this project is expected to generate 45 million tons of excavated materials as wastes, to which demolition wastes [1] will add. In the next 10 years, this ambitious project of the Paris metropolitan underground transit will enlarge horizon, including the development of new business clusters. More than 450 hectares will be transformed through many urban land planning projects to develop the cities around these new districts, housings, offices, shops and public facilities, in order to meet the Île-de-France region's needs.

¹ Corresponding author

The environmental impact of this megaproject will cost hard as energy expenses, also in balance of biodiversity because of the extension of urban areas at the expense of agricultural soils and the storage of a huge quantity of TBM-excavated geological materials. Rapid urban population growth, more production of greenhouse gases and more and more of impervious surfaces... these factors are mainly responsible for climate change. The concept of a technosol based on these mineral materials offers a new research line for scientists and land planners to compensate for green areas destruction and to minimize warming sources when building new urban areas.

Today, urban areas around the world are increasingly subject to extreme climatic and hydrological conditions and Île-de-France region is not spared from warming, as evidenced by two heat waves in June and July 2019. Many studies approached the topic of climate change and induced impacts on the urban environment at the global scale [2 - 5]. Among the most catastrophic impacts are floods, that is one of the biggest challenges for countries in terms of human security and economic damage. In United Kingdom for instance, annual damages due to flooding are estimated at 1.13 billion euros [6]. One of the main causes for flooding in urban areas is soil sealing that exacerbates runoff process whereas runoff from pervious areas remains uncertain owing to variable infiltration dynamics [8] compounded by the high exploitation and poverty of vegetation of urban soils. The total impervious surface of the world has been estimated to be 571,504 km² [7] which is close to the total area of France. The impact of climate change does not stop at this stage since it influences the quality of water, either as infiltrating water through polluted urban soils or as shallow water washing them.

The team of the MMOTIVVES project is engaged in environmental effort by proposing a technical-scientific solution for the valorization of certain quantity of TBM-excavated materials from the Paris Basin. The whole idea is to avoid storage of excavated materials as wastes and to give them a life. The main outlets for valorization of excavated materials are in road construction [9], aggregates for concrete and pavements, embankments, base and subbase course, raw materials for industrial production [10] or superstructure [11]. All these recycling works promote the urbanization of cities, but our approach is based on the development of green infrastructures in order to solve the ecological problems of cities, and particularly in the Île-de-France region.

The excavated materials of the Grand Paris Express will turn from waste to raw material for using in urban extension, specifically for developing urban soils. Those have already lost their ability to rend some vital services, especially their function of revegetation and food production. Excavated materials submitted to dedicated treatments will be used to develop a new fertile soil in green infrastructures which is in great demand in urban planning as a new concept against soil-sealing. This new urban soil is referred to as Anthroposol in the French Pedology Referential (FPR) [12] or in Australian classification, and Technosol in international terminology of the World Reference Base for soil Resources; it is also known as Technogenic superficial formation in Russian classification [13]. Practitioners and researchers suggested two implementation models of technosols: mixed or stratified model.

2. CHOICE OF A TECHNOSOL MODEL

2.1. Technosols – Anthroposols

In FPR, Anthroposols are soils heavily modified by human activity or man-made soils having more than 50 cm thickness from the soil surface, affecting small areas in urban soils and large areas in rural areas [12]. According to this reference, these young soils are grouped into five subclasses in table 1. In WRB classification, the properties and pedogenesis of technosols are dominated by a technical origin. There is three subtypes of technosols: (i) with artifacts (i.e. materials created or substantially modified by humans as a part of an industrial or artisanal manufacturing process or brought to the surface by human activity from a depth where they were not influenced by surface processes) having more than 20% by volume or weighted average artifacts in the first meter of soil or down to continuous rock or technic hard material or a cemented or indurated layer; (ii) with a geomembrane; (iii) with a technical hard material within 5 cm (hard materials created by humans are different from natural rock materials) [13].

Subclass of anthroposol in French & (in English)	Description
<i>Anthroposol transformé</i> (Transformed anthroposol)	Soils modified in order to improve their fertility, in rural areas. Anthroposol in WRB classification.
<i>Anthroposol artificiel</i> (Artificial anthroposol)	Soils having > 50% by volume of an anthropogenic material (technological: mine or quarry wastes, domestic wastes, sludges, slags, rubbles, etc.) mixed with natural soil-issued materials. Technosol in WRB 2006 classification; technosol with Hyperartefactif principal qualifier in WRB 2015.
<i>Anthroposol reconstitué</i> (Reconstituted anthroposol)	Soils using earthworks materials, road or motorway projects materials, industrial sites and quarries in order to fertilize soils in urban and peri-urban areas for revegetation and landscaping of gardens, parks and green spaces. Technosol with Garbic principal qualifier in WRB 2015 classification.
<i>Anthroposol construit</i> (Built anthroposol)	Soils using waste technological materials in order to fertilize the soil. The objective of these anthroposols is to have an accommodate environment, under good physical, chemical and biological conditions, to obtain a vegetation having an aesthetic role (greenery) and an environmental protective role (erosion and flood protection). Technosol in WRB 2006 and technosol with Spolic principal qualifier in WRB 2015 classification.
<i>Anthroposol archéologique</i> (Archaeological anthroposol)	The old anthroposols that were submitted to anthropogenic modifications. These soils containing archaeo-anthropogenic materials > 20% by volume. The archaeological anthroposols are the archives of humanity history.

Table 1: Subclasses of anthroposols in the FPR, French “Référentiel Pédologique” [12, 13].

According to the FPR, our anthroposol is classified as an “artificial and built” anthroposol (*anthroposol artificiel et construit* in French) and according to the WRB classification, it is a Garbic Spolic technosol. For the present concept, underground materials will be our primary materials to revegetate urban soils. For urban planners, technosols will be an alternative to use fertile agricultural soils which are a natural resource for the country [14]. Thus, several researches show that we can create a technosol according to our needs as physical properties (hydraulic, thermal, pedological, etc.) only from other materials [15 - 17]. These technosols will improve Grand Paris green infrastructures and provide air filtration, climate regulation, carbon sequestration and recreational ecosystem services. Our challenge is to create a draining soil that reduces the runoff coefficient hence flooding risk: a Garbic Spolic (Drainic) technosol. First, we have to know the characteristics of our recycled materials.

2.2. Geological nature of the Paris Basin excavated materials

According to the French Centre for tunnel studies [18], the Grand Paris Express will generate an average of 100 m³ as excavated materials per linear meter in tunnel construction sites, it is 200 to 250 tons / meter of various kind and quality of mineral materials, starting with hard limestone rocks and extending as far as clay soils. Between them we have the well-known geological formations of the Paris Basin “Marnes & caillasses” (marls and limestones) and “Sables de Beauchamp” (sands with presence of clay layers) [19]. Cuttings of hard limestone rocks are reusable as aggregates in the project, which is the most interesting from an economic viewpoint [20], and clay materials can be dried and used as backfill for underground quarries. The “Marnes & caillasses” represents one of the highest proportions of excavated materials, about 14% of the total or 5.606 million tons [19].

Marnes & caillasses are made up of marl and limestone and/or dolomite. Some layers were silicified and made harder at different stages of the diagenesis. In addition, some magnesian clay and gypsum (massive or as lenses) are irregularly present while very developed in some sectors of the GPE project. For instance, the cumulated vertical thickness of gypsum strata and lenses may be 12 m as observed along line 16, east from Paris [21]. Since the work by [22] and [23], these poor-quality rocks received little scientific attention except as a source of geotechnical risk. As for the carbonate content, either combined with calcium or magnesium, this formation includes little very marls (CO₃ content < 70%) but mainly marly limestones (70% < CO₃ content < 90%) or true limestone (CO₃ > 90%). However, these rocks are often tender due to their non-cohesive texture, which may explain by non-imbricated calcite or dolomite crystals and dissolution of diffuse gypsum. Classified as loam in the USDA triangle, we claim that recycling Marnes & caillasses into some technosol type should be feasible.

2.3. Technosol model from a published patent

Mixed model is a technosol where the recycled materials are mixed together to reach some targeted specific properties [15] or mixed with inert soil [14] or with nutritive elements to improve the pedological behavior of the in-situ soil [16]. This model can be implemented in one or more layers. Stratified model is interesting to improve global hydraulic properties of the soil in order to favor reaching of an effective pedological behavior. It was the object of a US patent in 2017 [17]. This technosol patent has two main functions: one is to keep water in the soil when there is little precipitation and to evacuate excess water by infiltration during any period of high intensity of rainfall; the other is the impediment to the arrival of salt from groundwater into the soil.

It consists of three layers as shown at figure 1. At the bottom is natural soil or soil referred to as original soil on site; in the middle, the water shield layer; and on top is the water retentive soil layer. The bottom layer is formed by sand of average particle diameter 100 μm , and the permeability Darcy coefficient is about 10^{-2} cm/sec. The top layer is made with sand excavated from the same in-situ material as the bottom layer. The middle layer must be less permeable and not retentive of water, so the patent recommends using repellent sand obtained by a specific treatment. The thickness of the bottom layer depends on the planned vegetation and it can be as deep as desired. The water shield layer is made to be 5 cm thick. It is crossed by drain plots in order to avoid rupture in the case of the top layer becoming saturated. In that way, the water retentive soil layer and the in-situ soil layer are connected to each other and excess water flows from the top layer to the bottom layer.

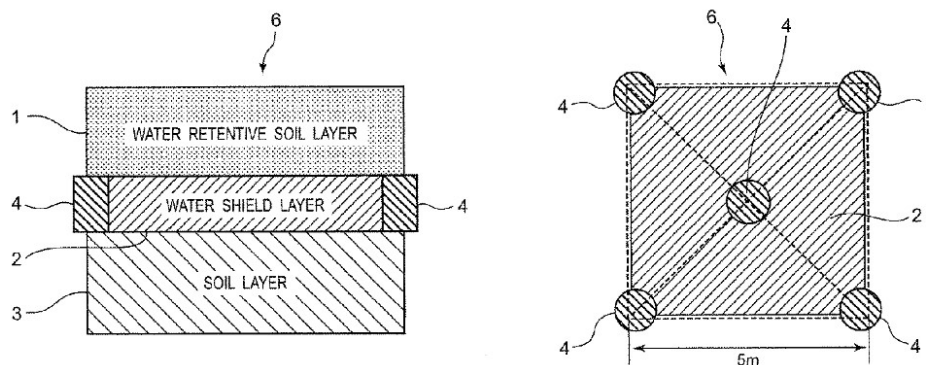

Figure 1: Technosol patent by Wakita et al. (2017): vertical cross-section and top-down view [17] with drain plots (component no 4).

To show the advantage of this stratified model of a technosol for controlling the hydrological functions in urban areas, a modelling approach will include a sensitivity analysis in order to determine which properties of the technosol are influencing transfer functions (water and heat) and deserve to be controlled for future design of real technosols.

3. NUMERICAL MODEL OF TRANSFER FUNCTIONS

This technosol model has been implemented with COMSOL [24] which is a multiphysics modeling tool based on finite element analysis allowing to solve various coupled physical and partial differential equations. COMSOL models can be constructed by predefined physical modules (heat transfer, fluid dynamics) or through user-defined equations. COMSOL can generate a mesh with different densities according to user specifications. Sandy loam soil was chosen because it has the same permeability coefficient as Marnes & caillasses. At first, a one-layer model was considered, 3 m thick and 14 m wide, with a low permeability boundary condition fixed at the base of the layer as shown at Figure 2. Secondly, a three-layers technosol was built by inserting a thin intermediate layer of lower permeability (silty clay) than sandy loam. This layer is crossed by drain plots to evacuate excess water from the top layer to depth. The same low permeability boundary condition as the one-layer model was fixed at the bottom. From the top, thickness of the 3 layers is respectively 0.5 m, 0.1 m and 2.4 m. COMSOL Multiphysics

was used to develop a coupled hydraulic and thermal model, based on Richard’s equation and heat transfer in porous media equation in unsaturated state. The pressure imposed at the surface simulates a state of low humidity within the soil. The main goal of running transfer functions through such a “dry” soil is production of initial conditions of temperature and humidity profiles.

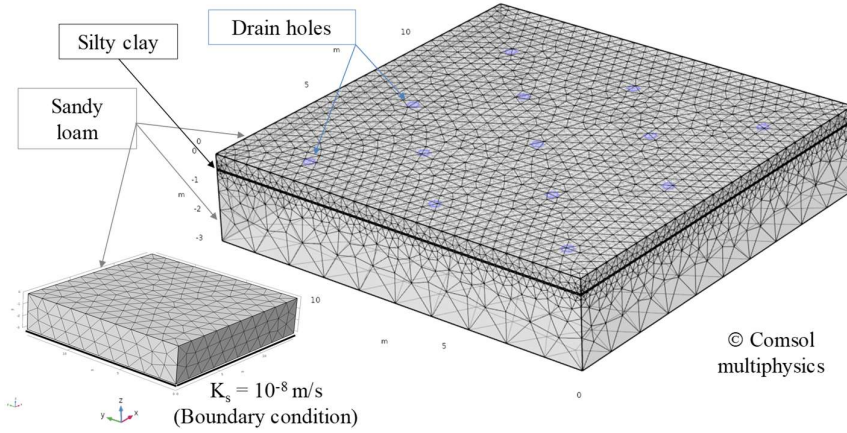

Figure 2: Meshing for coupled heat and water transfer: one-layer model and three-layers model.

3.1. Richard’s equation for unsaturated flow

Richard’s equation is used for flow in unsaturated soils (Equation 1):

$$\frac{\partial \theta}{\partial t} = \frac{\partial}{\partial t} \left[K(\theta) \left(\frac{\partial h}{\partial z} + 1 \right) \right] \quad (1)$$

The relationships of unsaturated hydraulic conductivity, soil moisture and pressure head can be described by the Brooks-Corey model, the Van Genuchten model, or a user-defined equation. In COMSOL, the Richard’s equation interface offers a platform to set parameters and initial and boundary conditions. Here the Van Genuchten retention model [25] and Mualem conductivity model were chosen:

$$\Theta = \frac{\theta - \theta_r}{\theta_s - \theta_r} = \left(\frac{1}{1 + (\alpha h)^n} \right)^m \quad (2)$$

where the subscripts s and r indicate saturated and residual values of the volumetric soil-water content (θ), h is the soil water tension and α , n and m are the model parameters.

The residual water content θ_r , saturated water content θ_s and the saturated hydraulic conductivity K_s are based on the UNSODA unsaturated soil hydraulic properties database [26].

Texture class	Basic parameter		Saturated hydraulic conductivity (cm/day)	Van Genuchten fitting parameter	
	θ_r	θ_s	K_s	α	n
Sandy loam	0.067	0.37	41.6	0.035	2.39
Silty clay	0.163	0.47	8.40	0.023	1.39

Table 2: Textural averages of hydraulic parameters for the Van Genuchten model.

3.2. Heat transfer in unsaturated porous medium

The heat transfer in a porous medium occurs by conduction, convection and dispersion according to the different thermal parameters (conductivities, heat capacity) occurring between the solid phase, the liquid phase and/or vapor. For the porous media, the effective thermal capacity is:

$$(\rho C_p)^* = \varepsilon(\rho C_p)_f + (1 - \varepsilon)(\rho C_p)_s \quad (3)$$

The effective thermal conductivity is:

$$\lambda^* = \varepsilon \lambda_f + (1 - \varepsilon) \lambda_s \quad (4)$$

The equation of conductive heat transfer is:

$$(\rho C_p)^* \frac{\partial T}{\partial t} = \nabla(\lambda^* \nabla T) \quad (5)$$

The equation of convective heat transfer is:

$$(\rho C_p)^* \frac{\partial T}{\partial t} + (\rho C_p)_f \vec{U} \cdot \nabla T = \nabla \cdot ((\lambda^* + \lambda_d) \nabla T) \quad (6)$$

where the subscript f indicates the flow domain, the subscript s indicates the solid phase, ε is soil porosity, t is time, T is temperature, \vec{U} is fluid velocity.

The effective thermal capacity ρC_p and the effective thermal conductivity λ are given at Table 3.

Texture class	Effective thermal capacity (MJ/m ³ .K)	Effective thermal conductivity (W/m.K)
	ρC_p	λ^*
Sandy loam	2.3	2.1
Silty clay	3.4	1.7

Table 3: Textural averages of effective thermal capacity and conductivity.

3.3. Boundary conditions

On one hand, temperature input along one year (Figure 3) is from MétéoFrance data measured in the air of atmosphere: one value T_{10} per 10 days, and each value T_{10} is averaged on 30 years data; the input to the model is periodic fluctuation of T by repeating 10 times this one-year cycle. The initial temperature of the soil is defined as the average annual temperature of the atmosphere $T = 10^\circ\text{C}$.

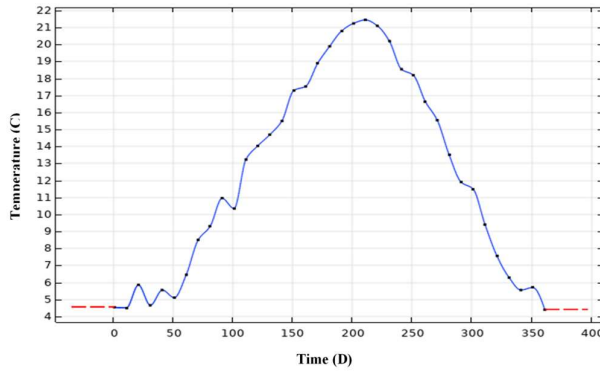

Figure 3: Temperature input along one year.

A convective heat flux has been imposed on the surface of the model by the equation:

$$q_0 = h_c (T_{10} - T) \quad (7)$$

where h_c is the heat transfer coefficient. The other boundaries of the model are defined as thermal insulation. On the other hand, the equilibrium pressure related to depth is a basic input to the model and the pressure differential at the surface, associated to a humidification scenario, is also one first order influencing factor, in Table 4.

Models	One-layer		Three-layers
Imposed pressure	-10 000 Pa	-16 000 Pa	-10 000 Pa
Minimum theoretical pressure	-28 000 Pa	-28 000 Pa	-28 000 Pa
Pressure differential at the surface	18 000 Pa	12 000 Pa	18 000 Pa

Table 4: Equilibrium and humidification water pressure.

4. COUPLED HYDROLOGICAL AND THERMAL SIMULATIONS

With the coupled hydrological-thermal model based on Richard's equation and heat transfer in porous media equation, run during a 10-years computation, the convergence of the volumetric water content and the periodicity of the temperature within the soil and damping of variation with depth are studied. The phenomenon depends on the permanent imposed pore water pressure at the surface of the soil.

4.1. Example of a one-layer model

For the one-layer model, two cases of imposed pressure are computed, high $-10,000$ Pa and low $-16,000$ Pa. The temperature and degree of saturation results are shown in Figure 4 and Figure 5 respectively. The measurements are made at point $(X;Y) = (7;7)$ at different depths (0; 0.5; 0.6; 2.5; 2.8 and 3 m).

The thermal transfer from the atmosphere through the soil during the permanent imposed pressure experiment displays a pseudo periodic fluctuation of temperature with some damping with increasing depth (Figure 4). For the highest case ($-10,000$ Pa) of imposed pressure, water infiltrating through the soil influences the groundwater temperature: after a 1-year delay, the signal at 3-m depth (in yellow) becomes superposed to the signals at 2.5 m or 2.8 m which are similar to the static saturated case (unshown). For the lowest case ($-16,000$ Pa) of imposed pressure, the influence slowly decreases from 2.5 to 2.8 m and no more influence on temperature is observed at the 3-m depth. As a conclusion, the temperature variation is enhanced by infiltration only when the soil humidity exceeds a threshold which is trespassed when surface pressure is around $-12,000$ Pa. At these tested pressure levels, the soil is still in dry condition. Let recall that the field capacity pressure for roots of common vegetation under the temperate climate is around -100 Pa.

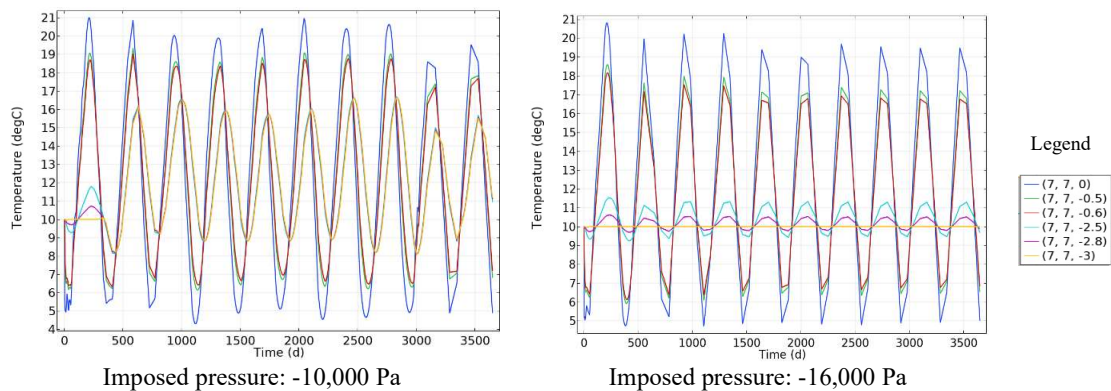

Figure 4: Temperature variation through the soil for two cases of the imposed pressure at the soil surface.

The results at Figure 5 show how the degree of saturation increases with time and converges after 4 to 5 years in the first case, 1 year in the second case, which proves low dynamics of water transfer in dry condition compared to heat transfer. The lower the pressure (the greater the suction) imposed on the surface, the faster the degree of saturation converges. Infiltration from the surface to depth modifies the humidity profile within the soil. For 180 days in the first case, imposed pressure of $-10,000$ Pa, the system is in transient state of water infiltration. For this case, after this transient stage, some recharge occurs: the saturated soil thickness is increasing with the piezometric level rising. No rise is observed in groundwater level for the second case of imposed pressure, that means no recharge of the phreatic aquifer exists below the pressure threshold around $-12,000$ Pa.

From this stage, it is easy to define initial humidity and temperature vertical profiles within the soil in equilibrium with the water table of the phreatic aquifer and the surface suction imposed. Moreover, in the aquifer, sub-horizontal Darcy flow may be computed according to a hydraulic gradient in order to handle outflows by drainage of the unsaturated soil. Then, another coupling could be added with the mechanical deformation of the soil, since settlement under loading at the surface should be accounted as a decrease in porosity. Another perspective is to compute some preferential flow in macropores with

the help of a double-porosity model. Then, the transition from drought condition to rainfall condition could be studied. However, the purpose of the present study is to test for the model of a patented technosol, so changing the structure and geometry of the soil has been preferred.

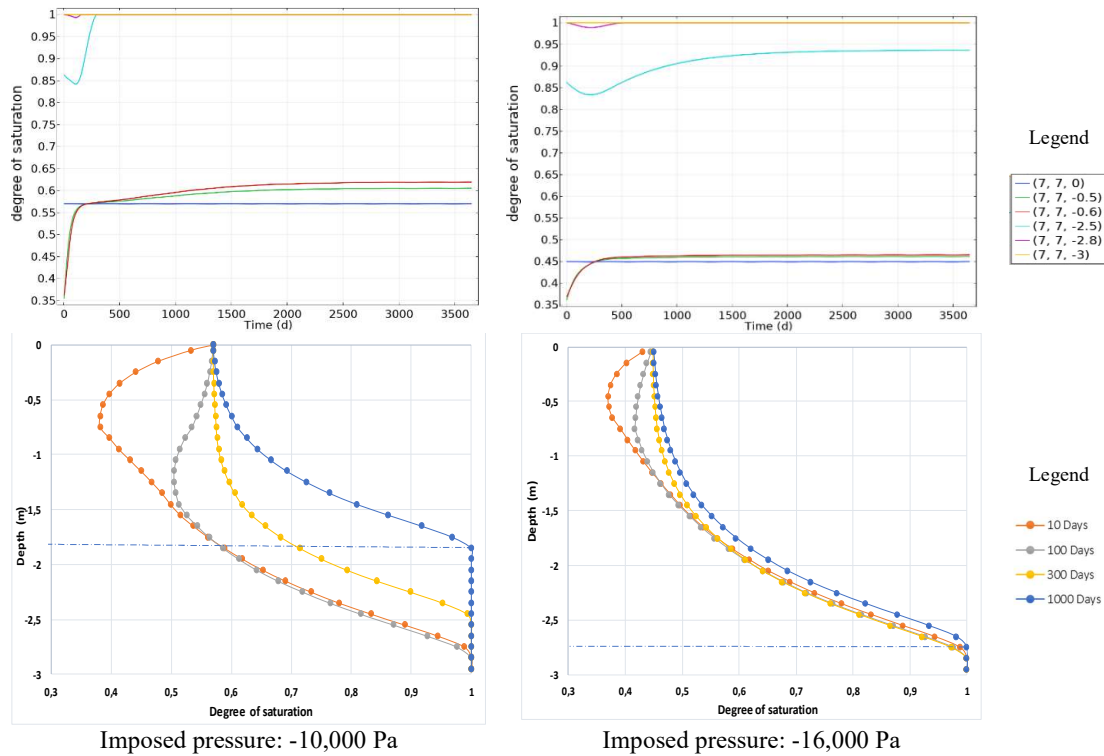

Figure 5: The degree of saturation of soil along with time (up) and with depth (down).

4.2. Example of a three-layers model

An imposed pressure of -10,000 Pa is considered for the three-layers model to compare with the one-layer model at the same imposed pressure which is above the unsaturated flow threshold. The temperature through the soil and degree of saturation results are shown in Figure 6 and Figure 7.

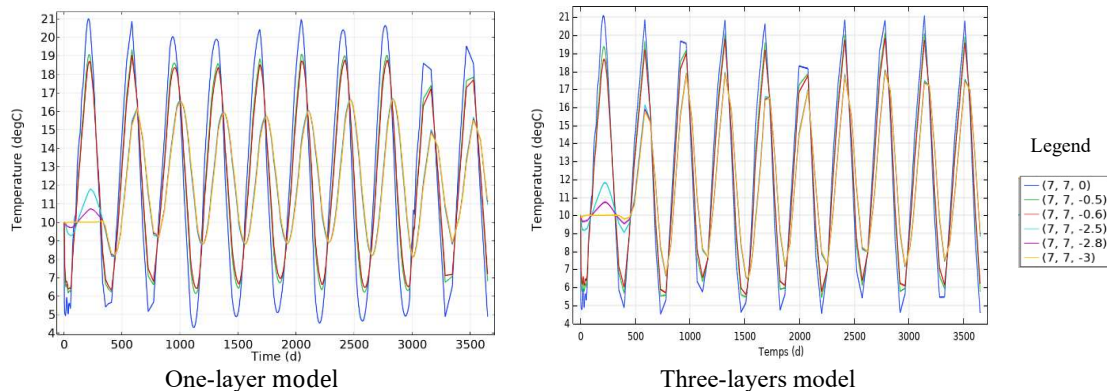

Figure 6: Thermal transfer through the soil.

Both models have a similar pseudo-periodic fluctuation of temperature. While the groundwater temperature has an average of 16°C for the one-layer model it increases by 1-2°C in the three-layers model. It is caused by the importance of effective thermal conductivity in the intermediate (silty clay)

layer. The latter model takes longer time to allow temperature to influence the groundwater which is attributed to higher thermal capacity in the silty clay layer.

The results at Figure 7 show that the degree of saturation in the top layer converges faster than the one-layer model, in the same case of pressure imposed. Convergence is reached after half a year in the 3-layers model. The degree of saturation increases by 5% in the water retentive soil layer that will receive the vegetation. Consequently, after the transient stage of infiltration which has the same duration in both models, some recharge to the aquifer occurs but the piezometric level in the bottom layer rises to 2.2 m depth in the three-layers model instead of 1.8 m depth in the one-layer model.

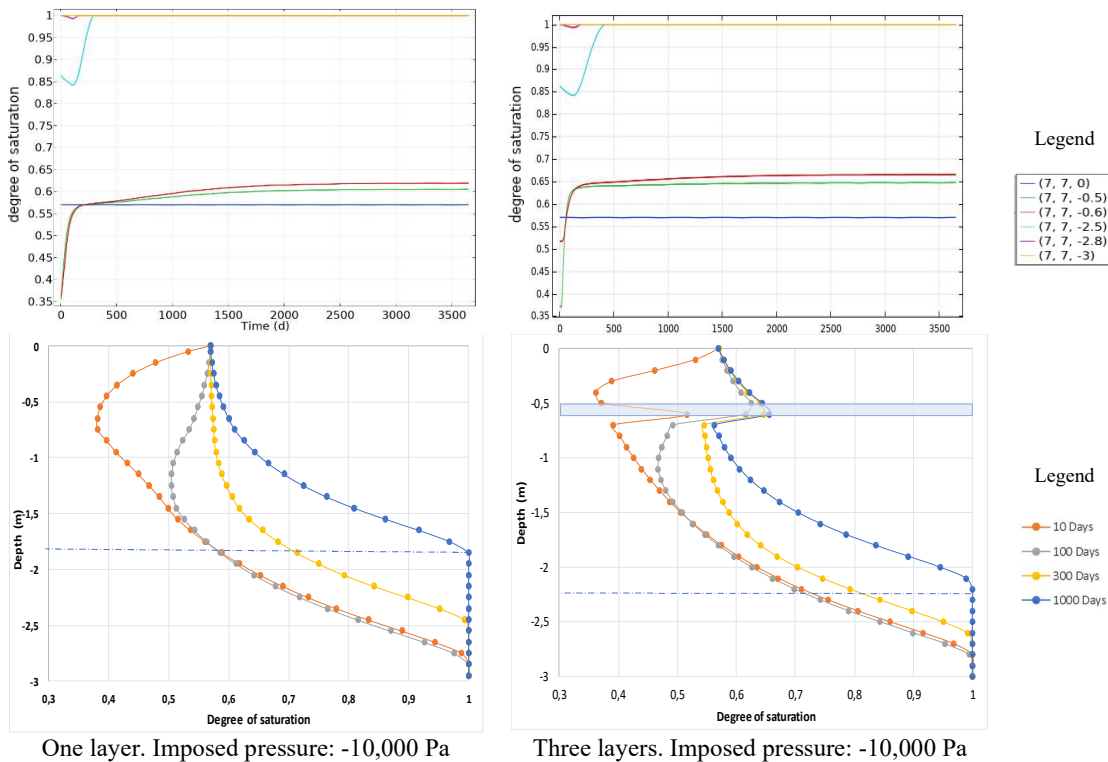

Figure 7: The degree of saturation of soil. The water shield layer is displayed in the 0.5-0.6 depth interval.

The coupled infiltration-heat transfer results prove the importance of testing a technosol patent with a multiphysic viewpoint. The installation of a water shield layer improves the retention capacity of the upper layer and this was expected by the authors of the patent. The drain plots (or holes) do not change the behavior significantly, except for a peak in water content at the bottom of the intermediate layer. Nevertheless, they did not plan to use the technosol as a thermal regulator and did not test for soil warming. The simulations show that an increase in temperature at depth in the soil will be induced by the water shield layer because of a textural control on water conductivity and thermal conductivity and capacity, as all physical parameters are related to porosity.

5. CONCLUSION

In this paper, a coupled hydrological and thermal model has been developed with COMSOL software for a one-layer and a three-layers model of technosol and simulations of a patented technosol have been performed in order to quantify the influence of hydraulic and thermal parameters on the properties of an artificial and built anthroposol. Results of simulations in relatively dry condition prove low permeability thin layer in this technosol indeed plays its role to keep more water above, in the retention layer dedicated to vegetation growth. However, it increases by 1-2°C the groundwater temperature below. To improve the concept of this technosol, the water shield layer of lower permeability should be made from a material without enhancing too much the effective thermal conductivity. The Richard model of flow

will turn to the Darcy model for flow in the saturated porous media, either in the top layer when intense rainfall increases the water content or in the phreatic aquifer under the bottom layer. With the help of such a modelling approach and with adapted technology of formulation and implementation of selected materials on the field, we can build a soil according to our needs. The construction of a coupled physical model of technosol provides the land planners with a tool for designing the implementation of complex materials such as Marnes & caillasses obtained from TBM-excitation in order to compensate for the colonization of peri-urban soils.

NOMENCLATURE

Symbol	Parameter or variable	Unit
q	Heat Flux	W/m ²
ρ	Density	Kg/m ³
C_p	Calorific mass Capacity of the Solid	J/ (kg.K)
$C_{p,w}$	Calorific mass Capacity of the Liquid	J/ (kg.K)
$(\rho C_p)^*$	Equivalent Calorific volume Capacity of the porous medium	J/ (m ³ .K)
λ_s	Thermal Conductivity of Solid	W/ (m.K)
λ_l	Thermal Conductivity of Liquid	W/ (m.K)
λ^*	Equivalent Thermal Conductivity of the porous medium	W/ (m.K)
∇T	Temperature Gradient	K/m
ε	Porosity	
θ	Volumic Fraction of Liquid	
θ_r	Residual Volumic Fraction of Liquid	
θ_s	Volumic Fraction of Liquid at Saturation	
Θ	Effective Degree of Saturation	
U	Flow velocity	m/s
h	Suction	Pa
z	Elevation	m
K_s	Saturated Hydraulic Conductivity	m/s
λ, α, n, m	Parameters of the water retention model	
h_c	Coefficient of thermal exchange	W/(m ² K)

ACKNOWLEDGEMENTS

CETU (Centre for tunnel studies) is acknowledged here for financial support to the preliminary stage of the project. Special thanks to Laetitia D'Aloïa, scientific coordinator at CETU.

REFERENCES AND CITATIONS

- [1] Société du Grand Paris (2018a). *Rapport d'activité 2017*.
- [2] Miller, J., & Hutchins, M. (2017). The impacts of urbanization and climate change on urban flooding and urban water quality: a review of the evidence concerning the United Kingdom. *J. Hydrology: Regional Studies*, **12**, 345-362.
- [3] Kundzewicz, Z.W., Kanae, S., & Seneviratne, S.I. (2013). Flood risk and climate change: global and regional perspectives. *Hydrol. Sci.*, **59**(1), 1-28.
- [4] Huong, H.T.L., & Pathirana, A. (2013). Urbanization and climate change impacts on future urban flooding in Can Tho city, Vietnam. *Hydrol. Earth Syst. Sci.*, **17**, 379-394.
- [5] Hunt, A., & Watkiss, P. (2011). Climate change impacts and adaptation in cities: a review of the literature. *J. Clim. Change*, **104**, 13-49.
- [6] Hall, J., Sayers, P., & Dawson, R. (2005). National-scale assessment of current and future flood risk in England and Wales. *J. Nat. Hazards*, **36** (1-2), 147-164.
- [7] Schneider, A., Friedl, M.A., & Potere, D. (2009). A new map of global urban extent from MODIS satellite data. *Environmental research letters*, 4 044003, 11 pp.
- [8] Scott, J. (2016). Impacts of urbanization on hydrological and water quality dynamics and urban water management. *Hydrol. Sci.*, **13**, 2295-2311.
- [9] Dumont, A.G. (2002). Utilisation des matériaux d'excavation de tunnels dans le domaine routier : état des connaissances actuelles. *Journée technique LAVOC « Choisir avec méthode »*.
- [10] Marini, P., & Bellopede, R. (2012). The use of tunnel muck as industrial raw material: two case-studies. *Rock Mechanics and Rock Engineering*, **46**, 397-404.
- [11] Foroutan, M., Hassan, M., Desrosiers, N., & Rupnow, T. (2018). Evaluation of the reuse and recycling of drill cuttings in concrete applications. *Construction and Building Materials*, **164**, 400-409.
- [12] Baize, D., & Girard, M.C. (2008). *Référentiel pédologique 2008*. Ed. Quae.
- [13] IUSS, Working Group WRB (2015). *World Reference Base for Soil Resources - International soil classification system for naming soils and creating legends for soil maps*. World Soil Resources Reports, FAO, Rome.
- [14] Deeb, M., Desjardins, T., Podwojewski, P., Pando, A., Blouin, M., & Lerch, T.Z. (2017). Interactive effects of compost, plants and earthworms on the aggregation of constructed technosols. *Geoderma*, **305**, 305-313.
- [15] Séré, G., Schwartz, C., Ouvrard, S., Sauvage, C., Renat, J.-C., & Morel, J.-L. (2008). Soil construction: a step for ecological reclamation of derelict lands. *J. of Soils and Sediments*, **8**, 130-136.
- [16] Zheng, H. (2016). *Artificial soil*. China patent No. CN 105613099A.

- [17] Wakita, Y.N., Mino, N.O., & Yamada, O.N. (2017). *Artificial soil structure and method of forming the same*. United States patent No. US 9,686,923 B2.
- [18] CETU. (2011). *Dossier pilote des tunnels, document n°5 : Environnement*.
- [19] Société du Grand Paris (2018b). *Catalogue des formations géologiques traversées par les tunnels et stations du Grand Paris Express*. Artemis.
- [20] Michel, P., Burdin, J., & Botte, J. (1999). Aménagement Cleuson–Dixence, revêtement de galerie à grande cadence : lot B. *Tunnels et ouvrages souterrains*, **153**, 51-163.
- [21] Egal, E. & Piraud, J. (2018). Review of some classical assumptions about the « Calcaire grossier » and « Marnes & caillasses » Lutetian formations. *Journées Nationales de Géotechnique et de Géologie de l'Ingénieur*. Champs-sur-Marne, France.
- [22] Gigan, J.P. (1974). Relations entre composition, texture et quelques propriétés géotechniques des Marnes et Caillasses. *Bulletin de liaison des laboratoires des Ponts & Chaussées*, n°72.
- [23] Filliat, G. (1981). *La pratique des sols et fondations*. Ed. Le Moniteur.
- [24] Comsol (2018). COMSOL multiphysics user's guide. Version 5.4.
- [25] Van Genuchten, M.T. (1980). A closed-form equation for predicting the hydraulic conductivity of unsaturated soils. *Soil Sci. Soc. Am. J.*, **44**, 892-898.
- [26] Or, D. & Wraith, J.M. (2001). *Soil Water Content and Water Potential Relationships, soil physics companion*. Edited by Arthur W. Warrick, Library of Congress, Washington, USA.