

NANOMECHANICS OF NATURAL FIBRES: A RAMAN STUDY OF KERATIN AND SILK FIBRES

Gwénaél Gouadec, Philippe Colomban, Hung-Manh Dinh

LADIR

University Pierre et Marie Curie (Paris 6)/CNRS

France

Bernard Mauchamps

UNS (Unité Nat Séricicole)

INRA – La Mulatière

France

Outline

Natural fibres

- Sustainable development ("clean" production, non toxicity, biodegradability, biocompatibility)
- Variable mechanical properties

ANR funding (2008-2010) : "Nanosoie" Raman spectroscopy of Silk fibres

- Find structural Raman probes in silk
- Use these probes to study the effect of chemical processing and mechanical loading on the mechanical properties

Why is μ RS suited to study fibres (mechanics) ?

- Sensitivity to bonds vibrations
 - \Rightarrow amorphous/low crystallinity solids
- Optical microscope
 - \Rightarrow probe targeting (spot $\sim 1 \mu\text{m} < R_{\text{fibre}}$)
 - \Rightarrow skin/core discrimination on cross-sections
- Non Contact Technique
 - \Rightarrow *in situ* analysis through translucent matrices or liquid solutions
- Stress measurements

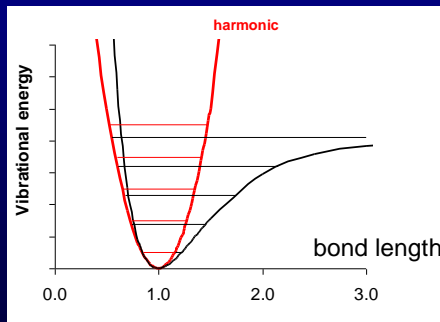
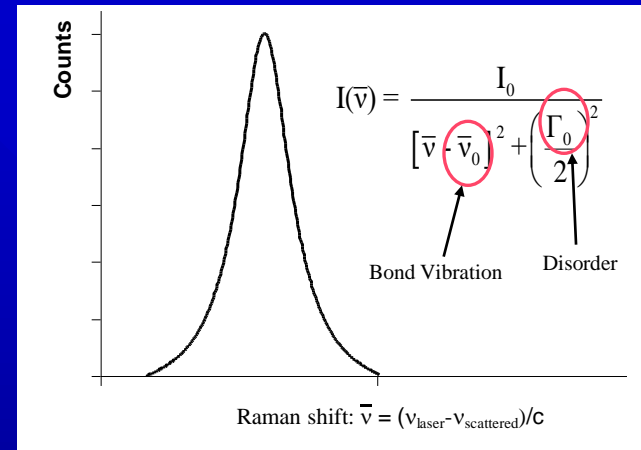

$$\bar{\nu}_{\text{vib}} \propto \sqrt{\frac{\partial^2 V}{\partial l_b^2}}$$

Bond stress probe

Macroscopic strain

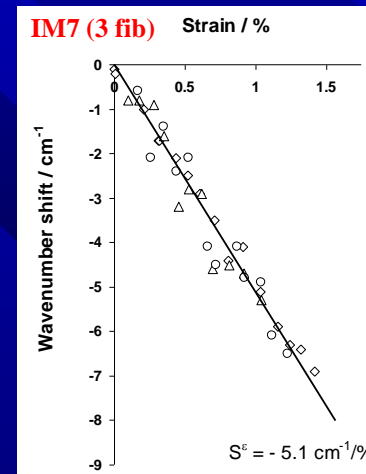

Colomban, Gouadec,
Mathez, Tschiemmer et
Pérès
Composites, PtA 37
(2006), 646

Bottom-up approach
to fibre mechanics !

Silk structure

polyamide chains (silk = spidroin ; hair = keratin)

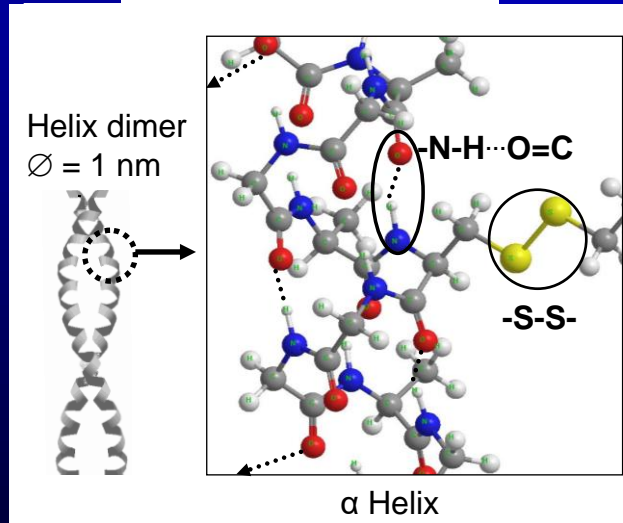
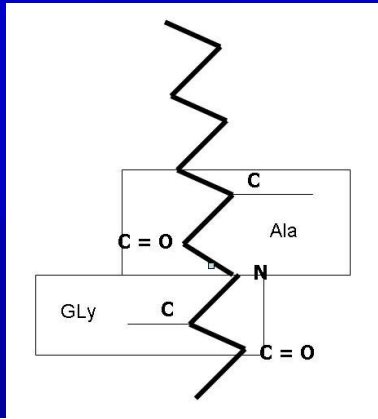

Chem 3D (force field calculations)

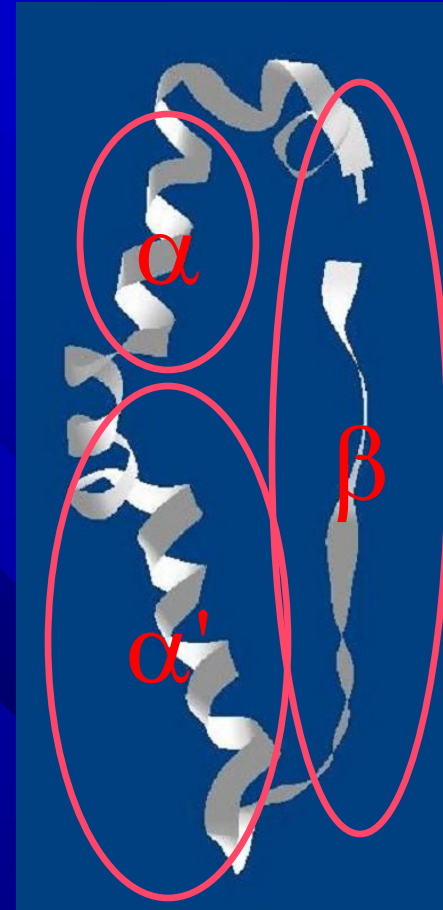

Spidroin
(72 amino acids)

Mechanical Testing

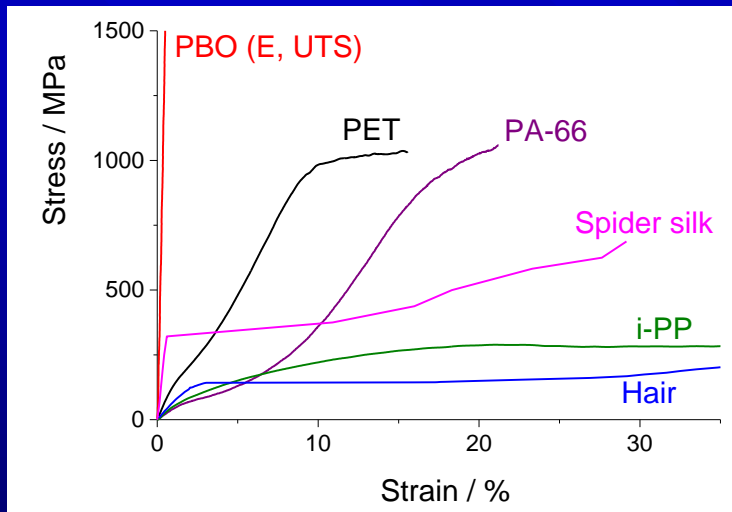

PBO poly(paraphénylène benzobisoxazole)
PET poly(éthylènetéréphthalate)
PA polyamide
PP polypropylène

Load/Strain controlled UFT
(0 to 100,00 g ; $\Delta l=0,001$ mm)

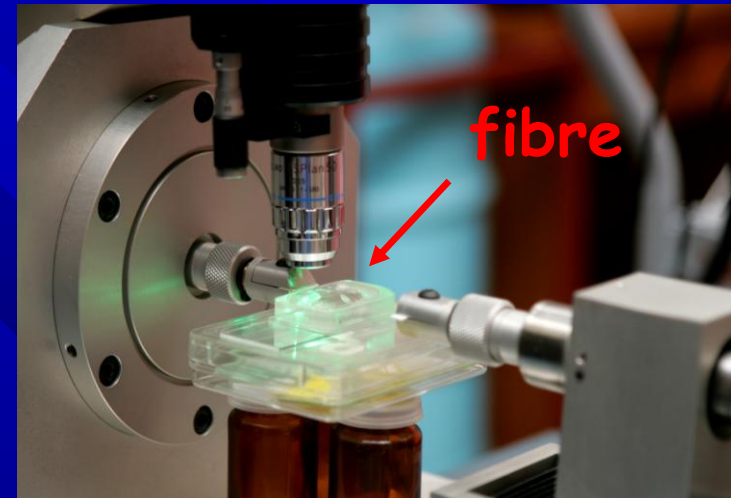

Gauge length = 30mm

Raman signatures-1

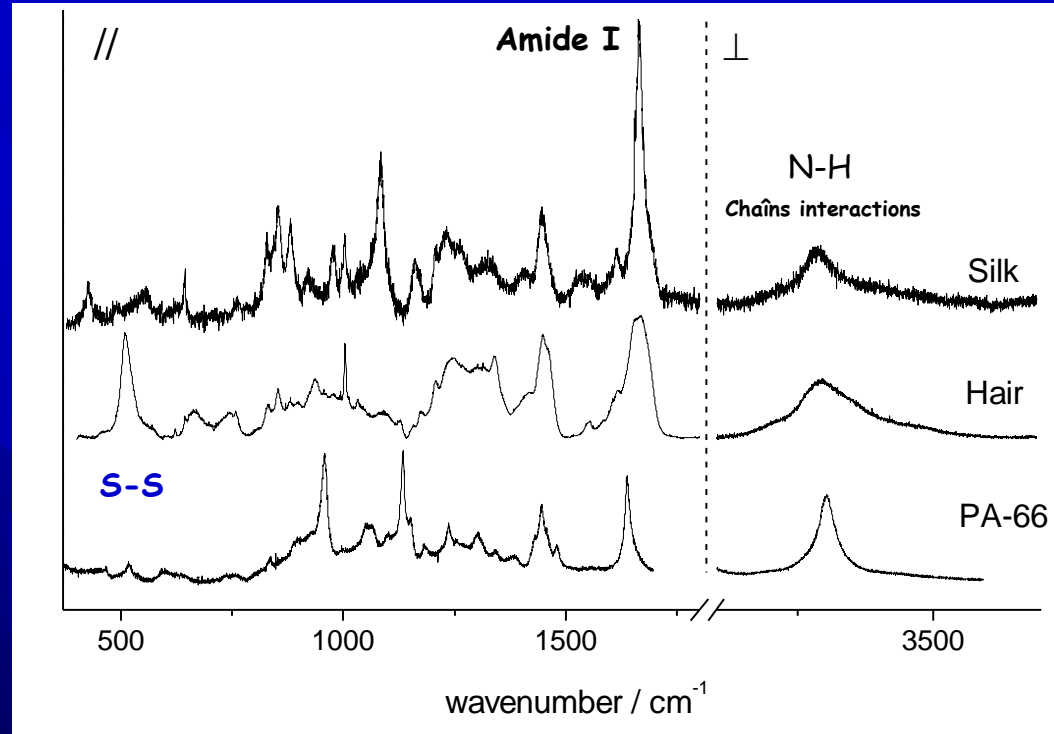
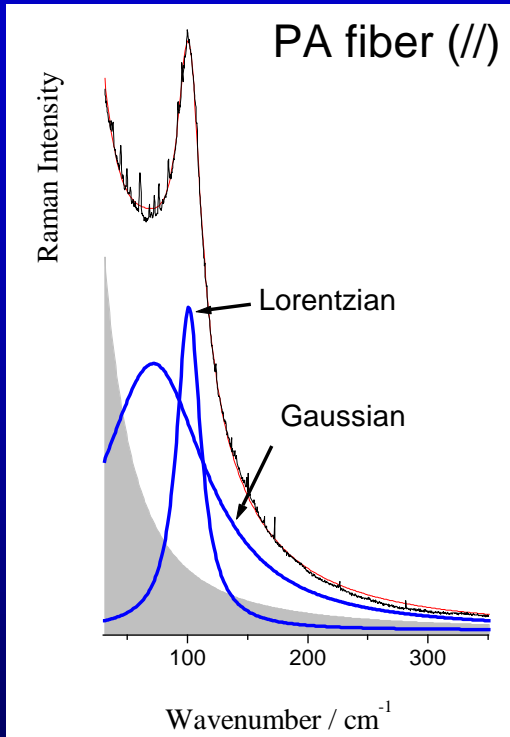

- Fluorescence + Acquisition time ~ hours
- High number of bands (superposition)

Raman signatures-2

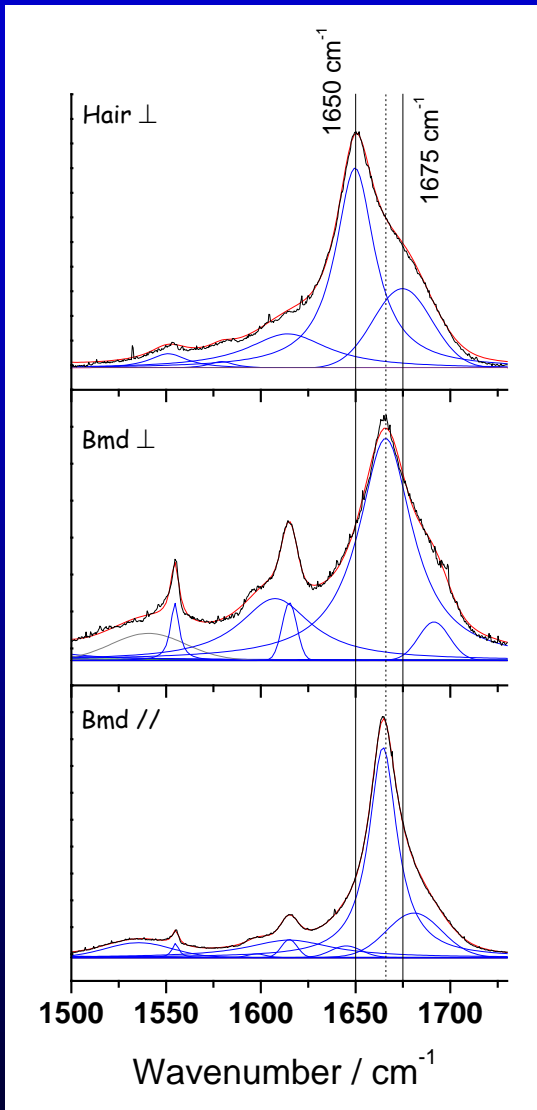

- Common set of components
 - ⇒ Fit validation
 - ⇒ Different phase proportions

- Assignments
 - G (1650) = alpha
 - G (1675) = beta sheets
 - L (1665) = intermediate
 - ⇒ Random coil



hair

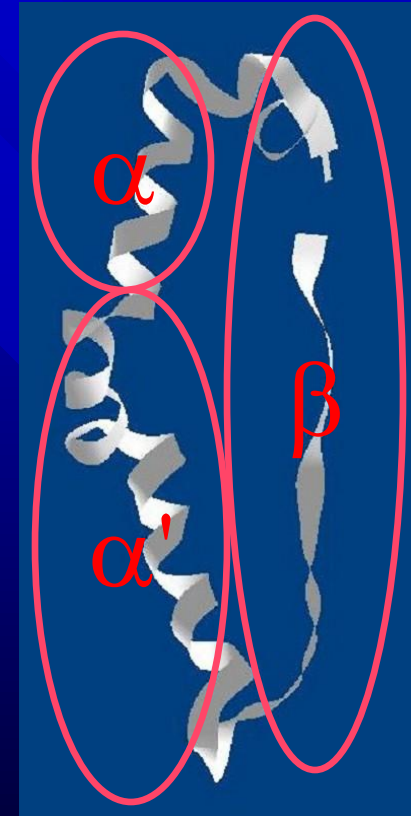

silk

PA66 fibre

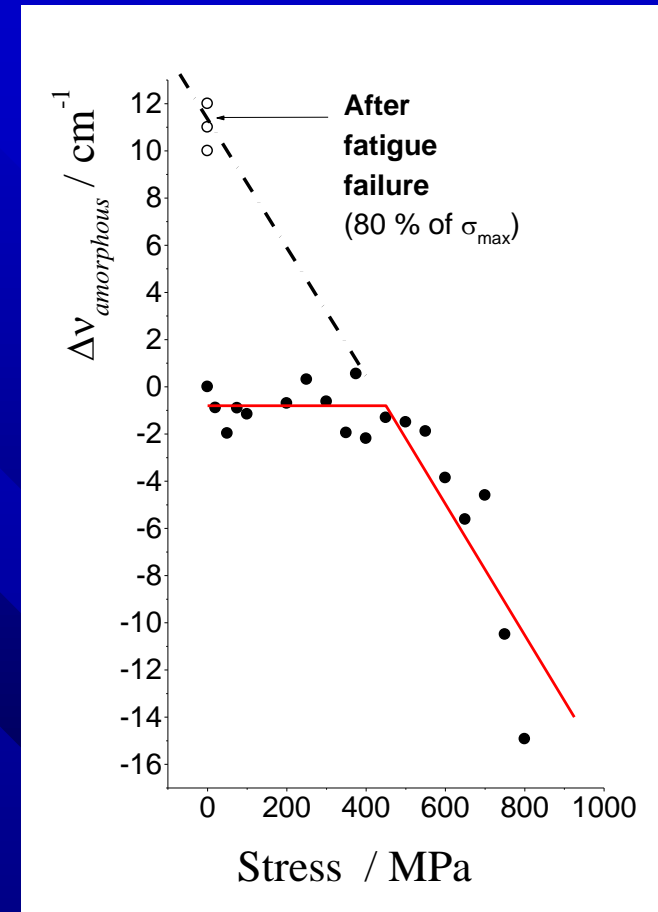
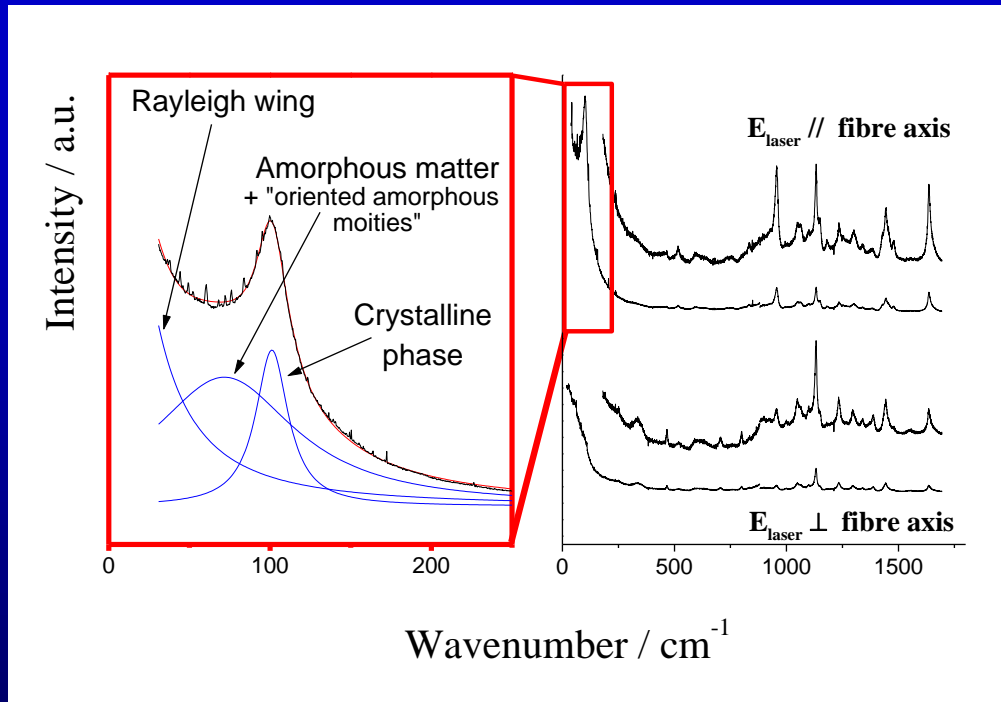

Marcellan A., Colomban Ph. and Bunsell A.

J. Raman Spectrosc. 35 (2004) 308

Herrera Ramirez J.M., Colomban Ph. and Bunsell A.

J. Raman Spectrosc. 35 (2004) 1063

Hair (white)

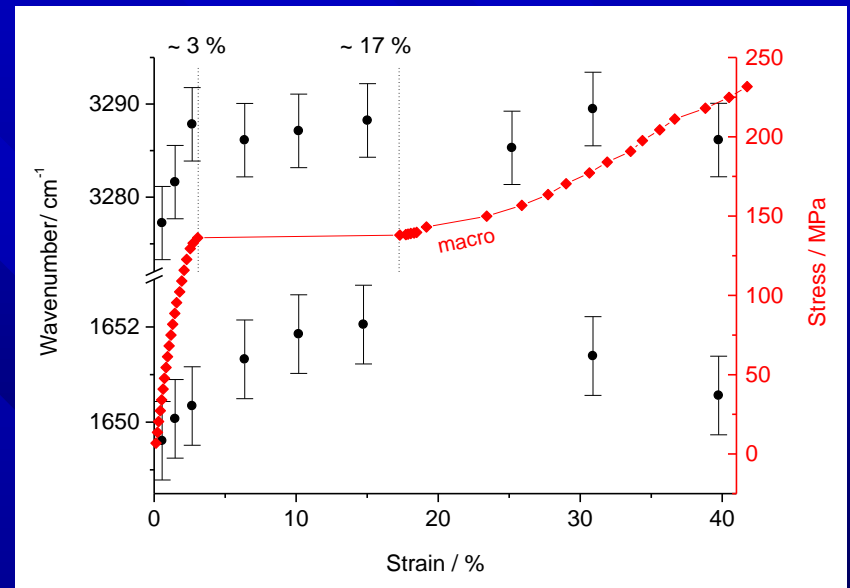
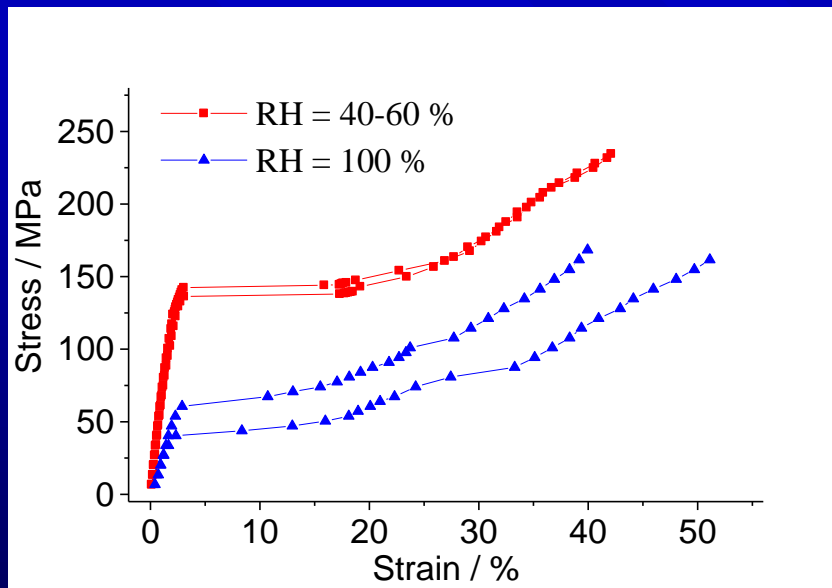

Paquin R. and Colomban Ph.

J. Raman Spectrosc. 38 (2007) 504

Bombyx Mori silk-1

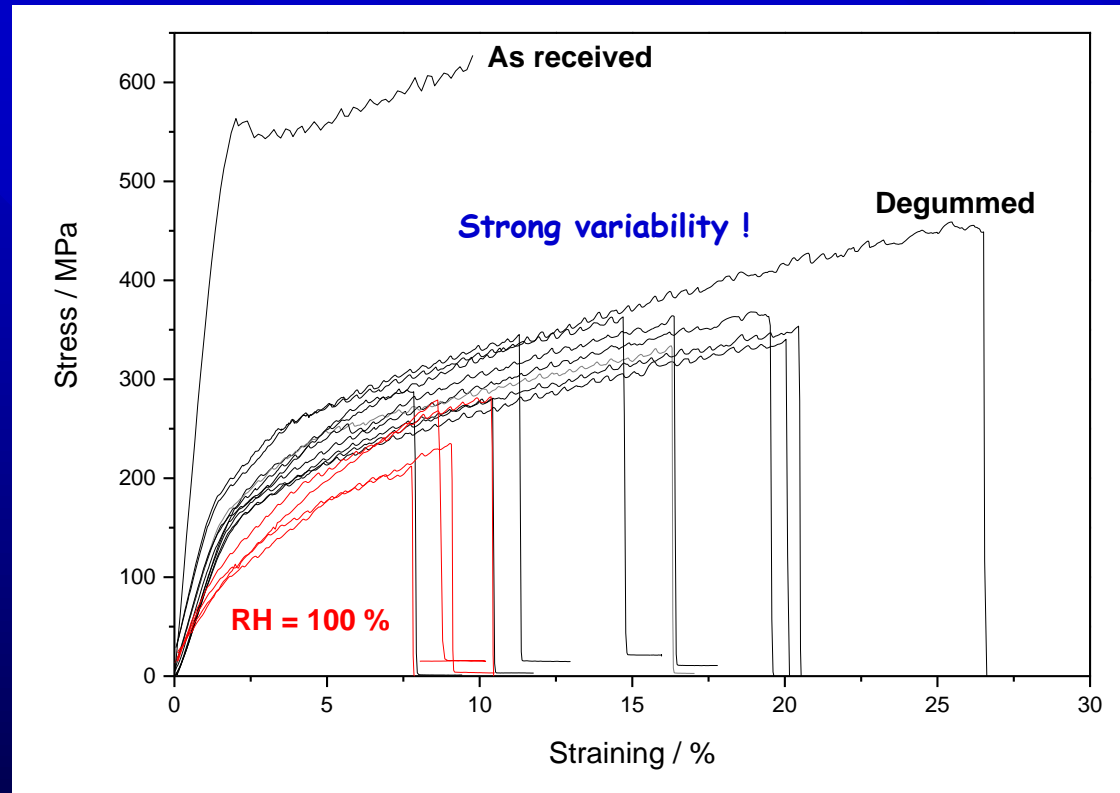

Bombyx Mori silk-2

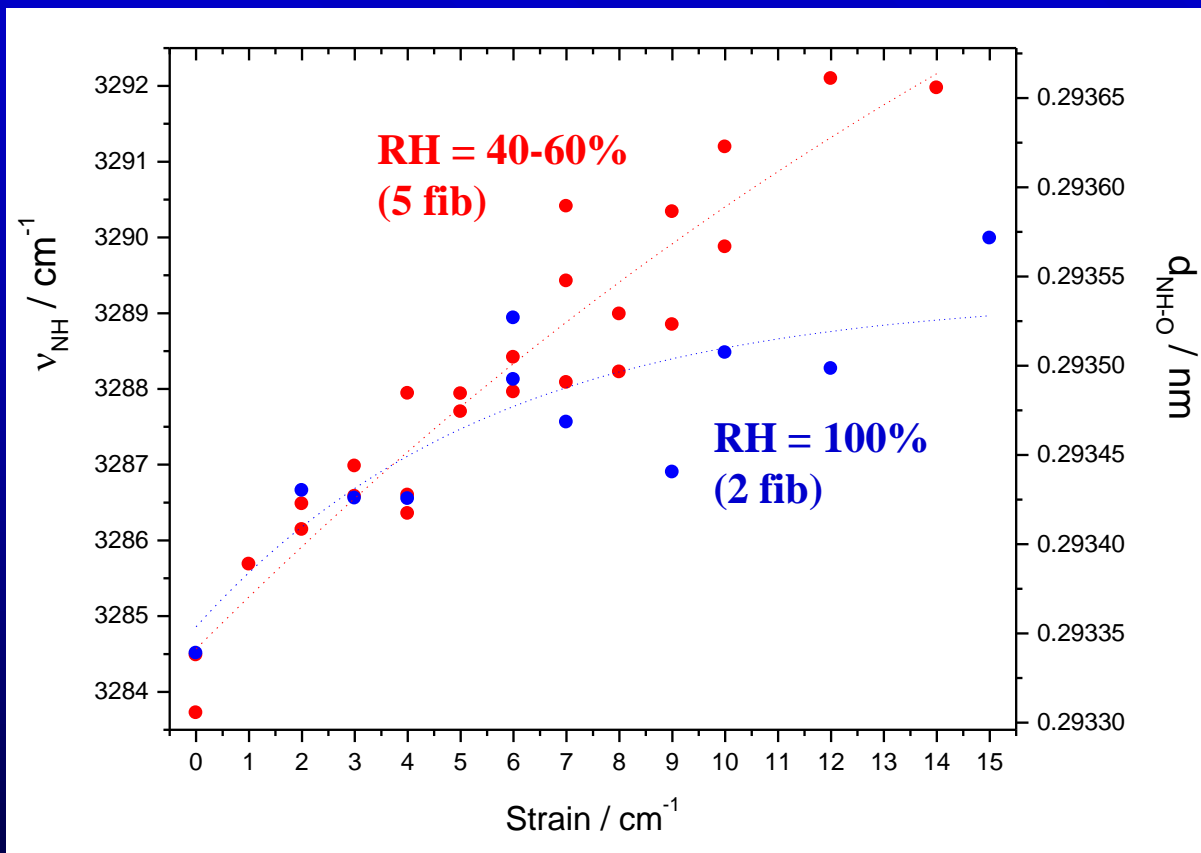

A. Gruger, A. Novak, A. Régis
and Ph. Colombari
Journal of Molecular Structure
Volume 328, 1 December
1994, Pages 153-167

Bombyx Mori silk-3

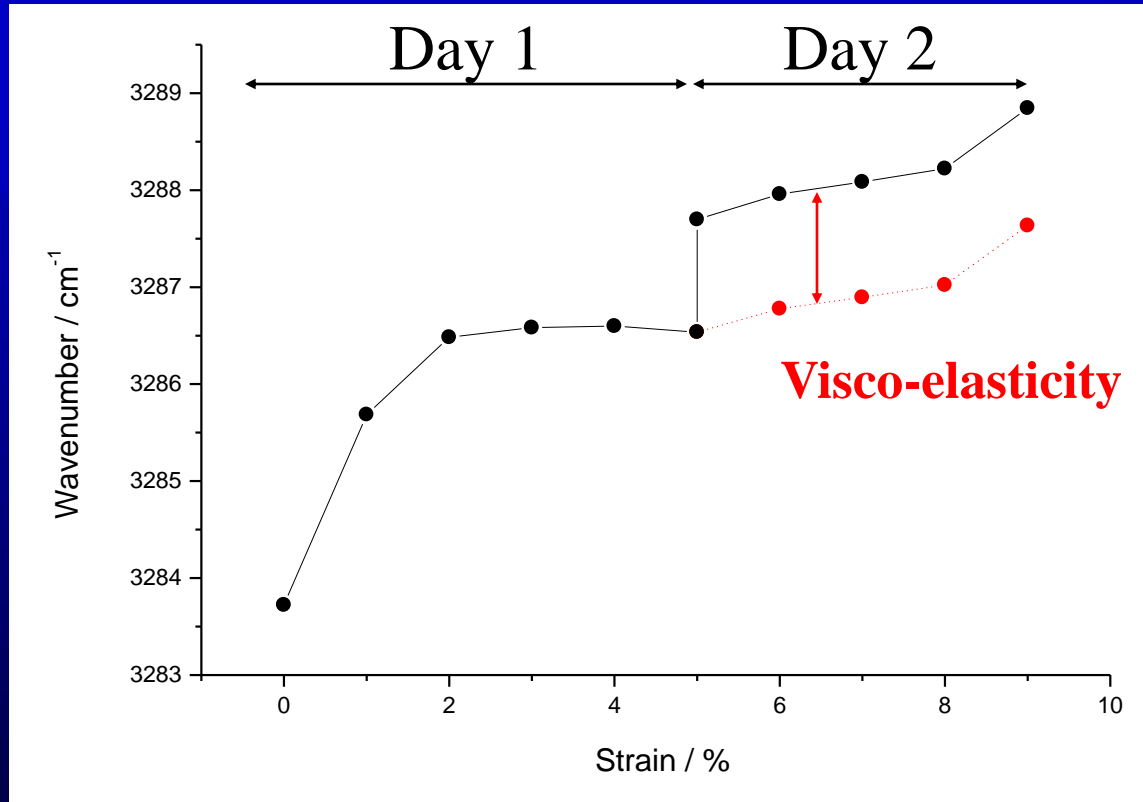

----- Conclusion -----

- Multi-scale nano-structural/mechanical Raman probes available

- ⇒ T' modes
- ⇒ Amide I
- ⇒ N-H

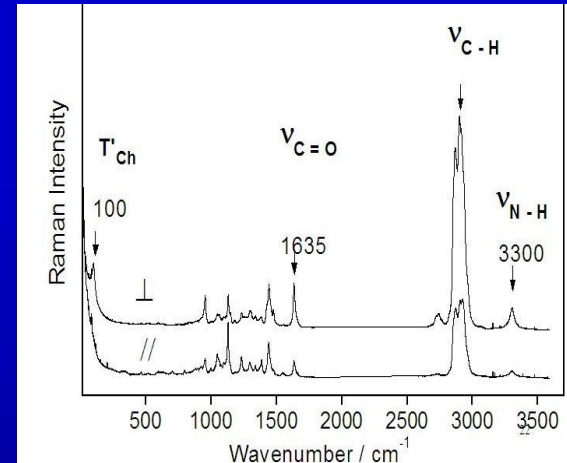

----- Future work -----

- Statistics on mechanics-governing factors:
 - ⇒ conservation (age) of the sample
 - ⇒ straining speed
 - ⇒ animal species (GM silkworms)
- Analysis of the structural changes and related mechanical effects occurring between silk secretion and its final application (clothing, ligament , silk/silk composite ...)

----- Acknowledgments -----

Pr. Anthony Bunsell (ENSMP)
Pr. Gérard Chavancy (UNS-INRA)
Raphaël Paquin
Salah Moukit

Post-doc funding
(Jan 2009 → Jan 2010)