



HAL
open science

Plasma assisted decomposition and reforming of greenhouse gases: A review of current status and emerging trends

Yugesh Vadikkeetil, Yugeswaran Subramaniam, Ramaswamy Murugan, P V Ananthapadmanabhan, Javad Mostaghimi, Larry Pershin, Catherine Batiot-Dupeyrat, Yasukazu Kobayashi

► To cite this version:

Yugesh Vadikkeetil, Yugeswaran Subramaniam, Ramaswamy Murugan, P V Ananthapadmanabhan, Javad Mostaghimi, et al.. Plasma assisted decomposition and reforming of greenhouse gases: A review of current status and emerging trends. *Renewable and Sustainable Energy Reviews*, 2022, 161, 10.1016/j.rser.2022.112343 . hal-04058331

HAL Id: hal-04058331

<https://hal.science/hal-04058331>

Submitted on 26 Apr 2023

HAL is a multi-disciplinary open access archive for the deposit and dissemination of scientific research documents, whether they are published or not. The documents may come from teaching and research institutions in France or abroad, or from public or private research centers.

L'archive ouverte pluridisciplinaire **HAL**, est destinée au dépôt et à la diffusion de documents scientifiques de niveau recherche, publiés ou non, émanant des établissements d'enseignement et de recherche français ou étrangers, des laboratoires publics ou privés.

Plasma assisted decomposition and reforming of greenhouse gases: A Review of current status and emerging trends

Yugesh.V¹, Yugeswaran Subramaniam^{1,*}, Ramaswamy Murugan¹, Ananthapadmanabhan P.V², Javad Mostaghimi³, Larry Pershin³, Catherine Batiot-Dupeyrat⁴, Yasukazu Kobayashi⁵

¹Department of Physics, Pondicherry University, Puducherry 605014, India

²Power beam Society of India

³Department of Mechanical and Industrial Engineering, University of Toronto, Canada

⁴Institute of Chemistry of Environments and Materials of Poitiers (IC2MP), Université de Poitiers, France

⁵Interdisciplinary Research Center for Catalytic Chemistry, National Institute of Advanced Industrial Science and Technology (AIST), 1-1-1 Higashi, Tsukuba, Ibaraki 305-8565, Japan

*= Corresponding author details yugesh.phy@pondiuni.edu.in

Abstract

Greenhouse gases are the major cause of global warming and it leads to climatic changes. It poses a major threat to the development of the global community and human civilization. The emission of greenhouse gases is gradually increasing due to fossil fuel consumption by the industries and automobiles. Effective control or reduction of greenhouse gases is a global challenge and has emerged as a major problem over the past few decades. The decomposition or conversion of greenhouse gases has lured various scientific communities. Worldwide numerous scientists are employing different methods to mitigate this problem. The major conventional methods that are used for decomposition of greenhouse gases are absorption, photocatalysis, electrochemical and thermochemical methods. Conventional methods have some drawbacks such as high capital cost and kinetic limitations in different steps. Additionally, the greenhouse gases are thermodynamically stable and are difficult to activate. Most of the conventional methods are encountering problems such as low selectivity, conversion and energy efficiency. Due to the setbacks of the conventional methods, several innovative approaches are being developed. Among these approaches, plasma technology is one of the feasible methods which has received immense attention from various scientific communities. Plasma assisted decomposition technique provides a complete or partial solution to the limitations of the conventional methods. This review presents the current state of art of plasma assisted decomposition and reforming of greenhouse gases.

Highlights

- Global warming and climate changes are the major threats for the sustainable growth and development of the human civilization.
- Greenhouse gases are major reason for the global warming.
- Plasma methods are n efficient methods for greenhouse gas treatment.
- We have reviewed the decomposition/ conversion of the major greenhouses such as CO₂, CH₄, N₂O and fluorinated gases using plasma technology.
- This review article consists of different plasma sources and plasma assisted catalytic conversion of major greenhouses such as CO₂, CH₄, N₂O and fluorinated gases.

Keywords

Greenhouse gases; Gas reformations ;Plasma ;Plasma assisted catalytic reformations

Word Count (12835)

1. Introduction

The progress of the human race and the use of natural resources are closely related. Among these resources, fossil fuels have particular importance. The Industrial revolution has changed the culture and lifestyle of the human race. Fossil fuels are the backbone of industrialization. They are widely used in automobiles, energy production, aviation etc. The significant portion (~ 80%) of the worldwide energy requirement is fulfilled by fossil fuels ever since the beginning of the industrial revolution [1]. The burning of fossil fuels emits various gases such as carbon dioxide (CO₂), methane (CH₄), nitrous oxide (N₂O), sulfur hexafluoride (SF₆) etc. These gases in the earth's atmosphere act as a greenhouse barrier and trap the solar radiations. These heat-capturing gases are known as greenhouse gases [2]. The greenhouse effect is a natural process which makes the earth a comfortable place to live by maintaining an average temperature on the earth.

The large-scale exploitation of fossil fuels dramatically increases the level of greenhouse gases in the atmosphere [3]. At the commencement of industrial revolution, the presence of atmospheric CO₂ stood at 280 ppm but it has reached 400 ppm in 2014 [4]. The world's energy consumption rate in the last ten years has doubled, while oil production rate has witnessed a growth of only 2.2% [5]. Numerous scientists have predicted that by the end of the 21st century due to man-made causes there would be an increase in atmospheric CO₂ and other greenhouse gases thereby leading to a growth in the worldwide average temperature by 0.3 to 4.8 °C (0.5 to 8.6 °F) relative to the 1986–2005 average. The excess quantity of greenhouse gases which cause climatic and ecosystem changes are followed via various environmental problems. The increase in global warming is altering the planet's climatic systems in countless ways. The large-scale emission of greenhouse gases has become a global issue in the past few decades. The global warming potential, atmospheric lifetime and the contribution of the greenhouse gases towards global warming are shown in Table 1. It is our responsibility to reduce and control the emission of greenhouse gases.

Table1. Global warming potentials and the atmospheric life time of greenhouse gases.[6]

Greenhouse gas	Global Warming Potential [GWP ₁₀₀ *]	Atmospheric Lifetime (years)	Contribution to the greenhouse effect [%]
Carbon dioxide (CO ₂)	1	50-200	80
Methane (CH ₄),	25	12	10
Nitrous oxide (N ₂ O)	298	120	7
Sulfur hexafluoride (SF ₆)	22,800	3200	3

*GWP₁₀₀: The global warming potential of the gas relative to CO₂ for a time interval of 100 years in atmosphere

The effective control and utilization of greenhouse gases has become a worldwide concern [7,8]. Various international agencies and countries have made various protocols and policies for the proper management of greenhouse gases. The Kyoto protocol is one among them. The Kyoto protocol is dedicated to reducing the emission of the predominant greenhouse gases which includes CO₂, CH₄, N₂O, perfluorocarbons (PFCs), hydrofluorocarbons (HFCs), and SF₆. This protocol stipulates effective guidelines for eliminating these gases [9].

Utilization or conversion of greenhouse gases into other fuels complies with the framework of sustainability and Green Chemistry. Therefore, the conversion of the greenhouse gases into value-added chemicals and liquid fuels is considered as one of the main challenges for the 21st century [5, 10]. Converting greenhouse gases provides us twin benefits; addressing the climate change issue and reducing our dependence on fossil fuels.

Currently different technologies are being used for greenhouse gas mitigations. They include replacement of fossil fuels, recovery and recycling of greenhouse gases and conversion of greenhouse gases into value-added chemicals. Various scientific groups are promoting to develop new energy sources that can serve as alternatives to fossil fuels. For instance, solar cells, windmills and tidal power are widely used as some of the alternative energy sources. These are ecofriendly as they do not produce greenhouse gases. However, these are not fully successful due to their cost and low efficiency. Advanced countries are on a quest for newer technologies to recover or recycle greenhouse gases, but it is still a long road to travel to make it economically viable. Fig.1. graphically represents the concept of 3R i.e. recover, reform and reuse of industrial waste greenhouse gases.



Fig.1. Concept of 3R: Recover, Reform and Reuse

The decomposition and conversion of greenhouse gases is the most promising approach for the reduction of greenhouse gases. The reformation of greenhouse gases into value-added chemicals or new fuels that can be alternatives for fossil fuels [11, 12] is widely prevalent. This will eventually reduce the greenhouse gases and convert them into alternate fuels which will help to meet the energy requirement process. As per the reports, the global consumption of energy is expected to rise by 30% in 2040 (relative to the year 2010) [13]. This situation demands other fuels for energy purposes. The renewable (e.g., solar and wind) and alternate (e.g., hydrogen, syngas) energy resources can play a major role in future. The conversion of greenhouse gases into other fuels like hydrogen, synthetic gas will lead to a new direction. This area of research is relatively new but it is widely accepted and has been actively pursued over the last few years.

At present, the decomposition or conversion of greenhouse gases has been extensively studied by many research groups via conventional thermal, chemical, electrochemical reduction, photochemical and biological methods. However, conventional methods require a huge amount of energy due to the high chemical stability of the greenhouse gases. Fig.2. represents the different methods of greenhouse gas decomposition.

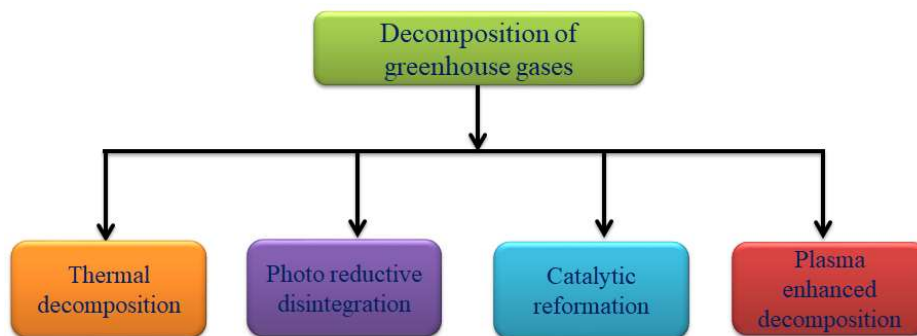
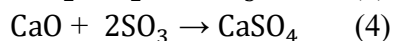
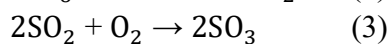
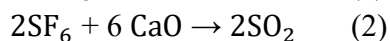
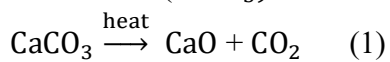

Fig.2. Classification of greenhouse gas decomposition

The thermal decomposition method is one of the broadly accepted methods for the decomposition of greenhouse gases [14]. The schematic diagram of the thermal decomposition is shown in Fig.3. This method is effectively used for the decomposition of SF₆ in the semiconductor industry. In this process, SF₆ molecules are converted into gypsum (CaSO₄) and fluorspar (CaF₂) through reacting with calcite (CaCO₃) as follows:



Meanwhile, thermal conversion of CO₂ requires very high temperatures which are practically very challenging to implement. It requires around 5000 K to achieve 100% conversion rate [15].

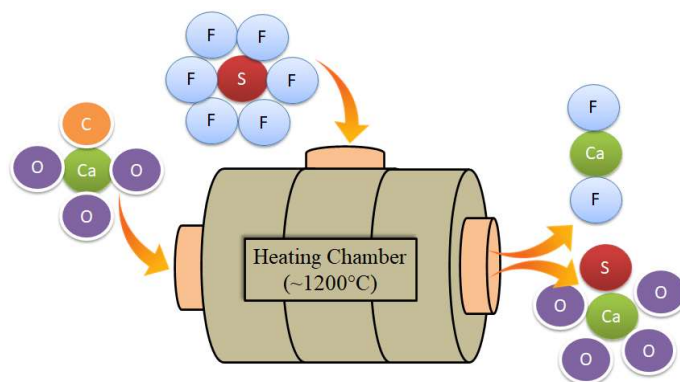

Fig.3. Schematic of thermal decomposition

Unfortunately, thermal decomposition has a major drawback which requires higher energy consumption than other decomposition methods. This higher temperature in the furnace can produce regulated NO_x emissions also. Compared to the conventional thermal decomposition method, the photochemical decomposition of greenhouse gases is relatively new. The major advantage of this method is that the formation of chemically energetic particles during the photolysis of some reductive agents like acetone, styrene and propane enables to disintegrate the greenhouse gases under ultraviolet light [16, 17]. The power consumption in this method is comparatively lower than other decomposition methods. However, the removal efficiency in this method is comparatively less and hence not suitable for practical applications.

The decomposition of greenhouse gases using the catalytic method is another promising approach. The studies on the catalytic reformation of greenhouse gases for continual energy development are blooming currently [18, 19, 20]. The schematic diagram of the catalytic dry reforming process is shown in Fig.4. Decomposition or reformation is an endothermic reaction. It requires high operating temperature for the efficient decomposition or conversion of the greenhouse gases. The presence of the catalyst reduces the operating temperature and enhances the dry reformation of methane [21, 22]. In general, the catalysts consist of support, active materials with or without promoters. The promoter is an additive which has no catalytic properties but it influences the activity, selectivity and stability of the catalyst.

The catalyst support is usually a solid material with a high surface area to which a catalyst is affixed. The active metal and promoters are loaded on the surface of the support. Generally, metals are used as active materials. Several promoters are added into a catalyst to investigate the influence of promoters. Detailed studies which reveal the interaction between support and active metals and mechanisms of catalytic reactions with or without promoters could be indexed as follows: (1) Size factor of particles: A mixture of small size particles of active metal, promoter and supporter in catalyst preparation leads to better dispersion, high specific surface area with more active sites and relatively high resistance against carbon deposition [23]. (2) Stronger metal-support interaction (SMSI): The interaction between the active metals and support materials directly influences the reforming efficiency [24]. (3) More active basic sites (MABS): Basic active sites have higher affinity towards acidic gases. Specific surface area of support and basicity of metal oxides on the

catalyst surface decides the fraction of active basic sites on the catalyst structure. The catalytic enhancements can be attributed to the above mechanisms, respectively.

Generally, noble metals like Pd, Pt, Rh, Ru, etc. and transition metals like Fe, Co and Ni are widely used for the dry reforming of CH₄ [25, 26, 27, 28]. The catalytic method is effectively used for the conversion of CH₄ into valuable products including higher hydrocarbons, hydrogen, synthesis gas, alkanes, methyl alcohol, carboxylic acids, alkanes, or aromatics [29, 30, 31, 32]. It is an emerging field in gas reformation and the quest for better catalysts continues. Meantime, the catalytic conversion of greenhouse gases is allied with several hitches such as high-temperature operation, sintering, coke formation, operational cost, low conversion rate and product selectivity. The use of catalyst reduces the operational temperature. However, a temperature of around 800⁰ C is required for good catalytic activity. Carbon deposition on catalyst inhibits the catalytic reaction. The catalytic deactivation is a major drawback for scaling up the catalytic reforming process.

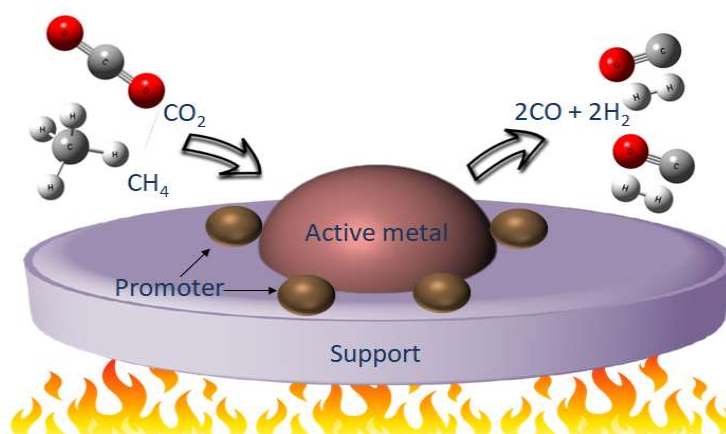

Fig.4. Schematic of catalytic decomposition of CO₂ /CH₄

Latest developments in the area of plasma assisted decomposition techniques provide a comprehensive solution to overcome the limitations of catalytic decomposition. Plasma has attracted immense attention for its high effectiveness in greenhouse gas decomposition and reformation. Plasma is partially or fully ionized gas, it contains active species such as ions, excited atoms, free radicals and energetic electrons [33, 34]. Plasma is mainly classified as non-thermal and thermal plasma depending on their temperature and extent of ionization. The properties of the plasma are mentioned in Section 2. Non-thermal plasma is widely used for greenhouse gas treatment due to its high non-equilibrium characteristics ($T_e \gg T_{gas}$) at low gas temperature. Even at room temperature, non-thermal plasma can easily break most of the chemical bonds by electron impact excitation, ionization and dissociation reactions. Further, it can facilitate some of the thermodynamically unfavorable chemical reactions at ambient conditions.

On the other hand, thermal plasma is also preferred to treat the greenhouse gases due to its exclusive properties such as high temperature and heat flux, intense reactive radicals, rapid reaction kinetics and controlled chemistry over large throughputs. Moreover, the formation of unwanted byproducts can be reduced in thermal plasma process by controlling the thermophysical

and chemical properties of thermal plasma medium. As a result, thermal plasma will become a promising tool for large scale treatment of greenhouse gases with higher conversion and good selectivity. So far, both non-thermal [27] and thermal plasma [35] are being used effectively for conversion /decomposition of greenhouse gases.

The current trend is to use the plasma assisted catalytic methods for the reformation of greenhouse gases [36, 37]. This plasma-catalytic hybrid process has the synergistic combination of the advantages of both plasma decomposition and catalytic decomposition method. There are a few ways to integrate the plasma and catalyst for the hybrid process: (1) Plasma catalyst pre-treatment (2) Double stage hybrid system and (3) Single stage hybrid system. In the first method, the catalyst is pretreated with non-thermal plasma to improve the activity of the catalyst materials for durability and selectivity. In double stage hybrid process, catalyst is positioned after the discharge region of plasma to induce synergistic effects of the plasma medium and the catalyst. This method is also called as post plasma catalysis (PPC), both non-thermal and plasma can be used for this hybrid system.

In single stage hybrid process, the catalyst is positioned within the discharge region. This process also named as In-plasma catalysis (IPC), which is suitable only for non-thermal plasma. In fact, the plasma system is complex with many reactive species that can induce chemical reactions, e.g., electron impact ionization and radical recombination. Hence, plasma-catalyst hybrid system would be more complex than plasma and although it enhances the reforming efficiency, we are yet to completely understand its reforming reaction mechanism. Development of energy efficient plasma-catalyst hybrid system and understanding of its reaction kinetics are the essential tasks to make this technology commercialized.

In this discussion, we would like to focus on the systematic review of the current status of conversion and decomposition of greenhouse gases using plasma technology and to attest that plasma technology is an alternative way to decompose or convert greenhouse gases in order to move towards clean and green environment. This article has been divided into 7 sections including general introduction. Section 2 introduces the plasma technology. Section 3 focuses on the decomposition of CO_2 . Section 4 describes the conversion methods of CH_4 . Section 5 and Section 6 describe the decomposition strategies that are being adopted for N_2O , and SF_6 gases respectively. Section 7 summarizes the conclusion and future outlook of the decomposition or conversion of the greenhouse gases using promising plasma technology.

2. Plasma technology

Plasma is generally considered as the fourth state of matter or ionized state of the matter [38]. Sir William Crookes referred plasma as the 'fourth state of matter'. The term 'plasma' [39] was first applied by Langmuir in 1928. Major portion (around 99%) of the matter in the universe exists in the form of plasma. A plasma is a partially ionized gas, containing free electrons, ions, radicals and typically also contains neutral particles (atoms, molecules) such as free radicals and stable molecules in ground and excited states [40]. Chen defined plasma as a quasi-neutral gas of charged

and neutral particles which exhibit collective behavior [41]. Quasi neutrality and collective behavior are the fundamental properties of the plasma. Plasma can occur naturally and it can also be created in laboratories. Lightning and ionosphere are examples of natural plasma; glow discharge, arc discharge, RF discharges, etc. are examples of laboratory generated plasmas.

2.1 Types of plasma

The plasma is characterized by its electron number density (n_e) and electron temperature (T_e). Based on these two parameters, natural and laboratory plasmas are classified as shown in Fig.5. The plasmas are mainly classified into thermal plasma (hot/equilibrium) and non-thermal plasma (cold/ non-equilibrium) depending on the state of thermal equilibrium.

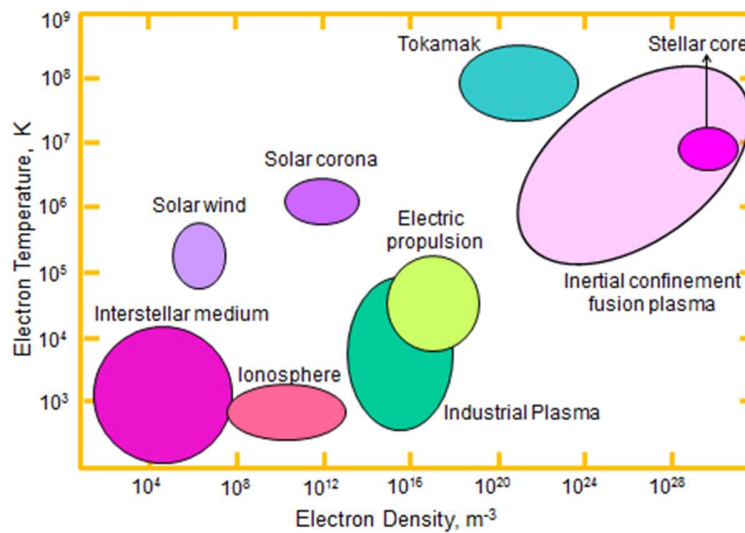

Fig. 5. Classification of the plasmas depending on the electron number density (n_e) and electron temperature (T_e).

2.1.1 Non thermal plasma

In a non-thermal plasma, the temperature of the electron is much higher than the temperature of the heavy particles (ions and atoms). The bulk temperature and electron density of the non-thermal plasma are in the range of 300 K - 1000 K and $< 10^{19} \text{m}^{-3}$ respectively. The non-thermal plasmas are characterized by low electron number density and low gas temperature. The highly energetic electrons will lead to the generation of some highly active species including radicals [42, 43, 44]. Presence of these reactive species at room temperature provides a control over the chemical selectivity of a process, thus favored in many chemical processing applications. Non-thermal plasma produced at atmospheric and below atmospheric pressure have been extensively used in various fields of research including physics, medicine and material science [45, 46, 47, 48, 49, 50].

2.1.2 Thermal plasma

In thermal plasma, the temperature of electrons and heavy particles are nearly equal. This type of plasma is generated at atmospheric or near atmospheric pressures. The bulk temperature and electron density of the thermal plasma is in the range of 10,000 K - 30,000 K and $10^{21} - 10^{26} /\text{m}^3$ respectively. The main advantages of the thermal plasma are its high temperature and high energy density. The thermal plasma can reach a temperature of 20,000 K or more, whereas the higher temperature limit of the fossil fuel is around 3,000 K only. Thermal plasma is characterized by the high electron number density and high gas temperature [51]. Due to high temperature and high enthalpy of the thermal plasmas, they are widely used for various high temperature industrial applications such as synthesis of nanostructures [52, 53], disposal of waste materials [54, 55], material spheroidization [56], metallurgical applications [57, 58], surface modification through nitriding [59, 60] and thermal barrier coatings [61, 62] etc. Comparison between thermal and non-thermal plasma is illustrated in Table 2.

Table.2. Comparison between thermal and non-thermal plasma

	Thermal plasma	Non-thermal plasma
Temperature	>10,000 K	~300-1000 K
Discharge volume	High	Low
Reaction conversion	High	Low
Input flow rate	High	Low
Difficulty of Operation	High	Low
Safety precautions	High	Low
Cost factor	High	Low
Working pressure	Atmospheric pressure and slightly above	Atmospheric pressure and low pressure

2.2 Plasma generation

Plasma can be generated by different methods. Thermal excitation is one of the simplest methods used for generation of plasma. When heat energy is supplied to the neutral gas to heat it to a temperature of few thousands of degrees, the gas molecules acquire enough energy for spontaneous dissociation, excitation and ionization to take place. However, this method of plasma generation has some practical restrictions related to the operation. Another most common technique for plasma generation is by applying electric field to a neutral gas. A typical example is the DC plasma generation. In this method, the applied potential difference between the two electrodes causes an electrical discharge on the gas medium in between the electrodes. The voltage can be in the order of thousands of volts and for gas at atmospheric pressure, it can be roughly estimated to be about 3 kV for a distance of 1 mm of gas column between the electrodes [63].

Plasma can be generated by applying electromagnetic radiations. The electromagnetic energy is transferred from the high-frequency (1-10MHz) source to the plasma gas either by a coil or a set of capacitor plates, resulting in an inductive or capacitive coupling between electrical and magnetic

fields. No electrodes are used in this method of plasma generation. Microwave is another source to produce plasma. The microwave source consists of a microwave generator, wave-guide apparatus and impedance-matching mode converter, which couples the microwave power to a coaxial wave-guide and a quartz window. For jet like plasma production, central conductor of the coaxial wave-guide acts as one of the electrodes and the annular flange function as the outer coaxial electrode. When a microwave power of optimum frequency is applied, electrical break down occurs in the working gas and plasma is formed, driven by microwave energy.

2.3 Plasma sources

Depending upon plasma discharge, various plasma sources are used for different applications. Atmospheric pressure plasma sources are more appropriate for the decomposition/conversion of greenhouse gases. Atmospheric pressure plasma devices do not require vacuum devices. The different plasma sources that are used for decomposition of greenhouse gases are described below.

2.3.1 Dielectric barrier discharge (DBD)

Dielectric barrier discharge (DBD) is a commonly used method for generating non-thermal plasmas at atmospheric pressure. It is also called “silent” and “atmospheric-pressure-glow” discharges [64, 65]. The schematic of the dielectric barrier discharge (DBD) is shown in Fig.6a. In this configuration at least one electrode should be separated by a layer of dielectric material such as quartz, glass, ceramics, polymers, etc. for limiting the current flow. The application of high voltage accumulates the electric charges on the dielectric material and generates plasma as short-lived streamers. The gap between the electrodes is in the order of several mm and the applied voltage is around few kV. The plasma is generated as a micro arc for a few seconds (10-100 ns) and is randomly distributed in space and time. These streamers are believed to be few tens of (10 - 100 μm) in diameter. A non-uniform, filamentary structure consisting of a series of micro discharges [64, 65]. DBD plasmas typically operate with either an AC (frequency: kHz-MHz) or in a pulsed DC mode. DBD are feebly ionized with a large number of active particles present in the plasma medium. It is easy to construct in different geometry and therefore, widely used for surface treatments of materials such as polymers, textiles [66, 67] ozone generation [68, 69], and air sterilization in heating [70]. DBD is an efficient tool for material processing applications [71], plasma-assisted chemical vapor deposition of polymers [65] and glass films [72].

2.3.2 Corona discharge (CD)

The corona discharge is one of the weakly ionized and highly non-equilibrium plasmas. It can be found in nature during electrical storms near sharp edges and points. The name called ‘Corona’ comes because the plasma creates a lighting crown around the electrodes during the discharge. Fig.6 (b) shows the schematic of corona discharge. Corona discharge is relatively a low power discharge at atmospheric pressure. Generally, it is generated by high electric fields in association with a sharp needle tip or small diameter of the wire. The inhomogeneous electric field causes a partial breakdown of the narrow gap. The localized corona glow can be observed in several forms depending upon the polarity of the field and the electrode geometrical configuration. The main

advantage of the corona discharge is that it is easy to establish. Due to this convenience, corona discharge is widely used in ozone production [73], water treatment [74], removal of unwanted volatile organics [75] and material treatment [76, 77, 78].

2.3.3 Gliding arc discharge (GAD)

Gliding arc discharge is an alternative to high power thermal arc systems and it is a type of transitional non-thermal plasma. Gliding arc generates both thermal and non-thermal regimes of the plasma at atmospheric pressure [79]. Fig.6 (c) shows a schematic of a planar gliding arc discharge configuration. The gliding arc plasma is weakly ionized and the energy of the electrons is markedly higher than that of the heavy species. It has been reported that the electron temperature in the non-equilibrium regions is around 11600 K. Vibration and translational temperatures are around 2000-3000 K and 800-2100 K. AC gliding arc, rotating gliding arc, three-phase gliding arc generators with several parallel or serial electrodes have been designed for various purposes including greenhouse gas treatment. In this case, the arc ignites at the shortest gap of electrodes due to the applied high voltage between the electrodes which provides the intense electric field to break down the gas. At this instant of time current is at its maximum value and voltage is at its lowest value. A transverse gas is introduced that pushes the arc and arc gets elongated. The elongation of the arc depends on the input power. The gliding arc discharge utilizes more than 80% of its input power for chemical reaction, hence the energy utilization rate is high. Relatively low energy costs and greater efficiency of gliding arc discharge makes its one of the most attractive advanced oxidation techniques. The vortex type gliding arc provides good mixing and contact of the plasma discharge. The gliding arc discharge plasma has been applied in a wide range of environmental applications [80, 81, 82], energy conversion [83, 84], material processing [85, 86, 87] and medical science [88, 89, 90].

2.3.4 Microwave and radio frequency plasma discharge

These type of plasma generators use high frequency electromagnetic waves for plasma generation. Fig. 6 (d) shows the schematic view of the microwave discharge plasma. In microwave discharge, collision of oscillating electrons with gaseous atoms and molecules generates the plasma with high degree of ionization. Electron oscillation can be controlled by the microwave frequency. The advantage of this microwave plasma source is that it does not need electrodes. In radio frequency discharge, electromagnetic fields generated by the power supply interact with the plasma gas through inductive or capacitive coupling. Inductive coupling is used to generate thermal plasma and the capacitive coupling is used for generating non-thermal plasmas. The frequencies used to generate RF plasmas are typically in the range between 0.1 and 100 MHz. This type of plasma source can be used with various applications due to its unique characteristics such as high temperature and electrode free operation. Electrode less plasma source is widely used in the field of production of high purity nanomaterials, nanotubes [91] and other advanced materials [92]. It has the ability to produce plasma by using all kinds of gases at atmospheric pressure.

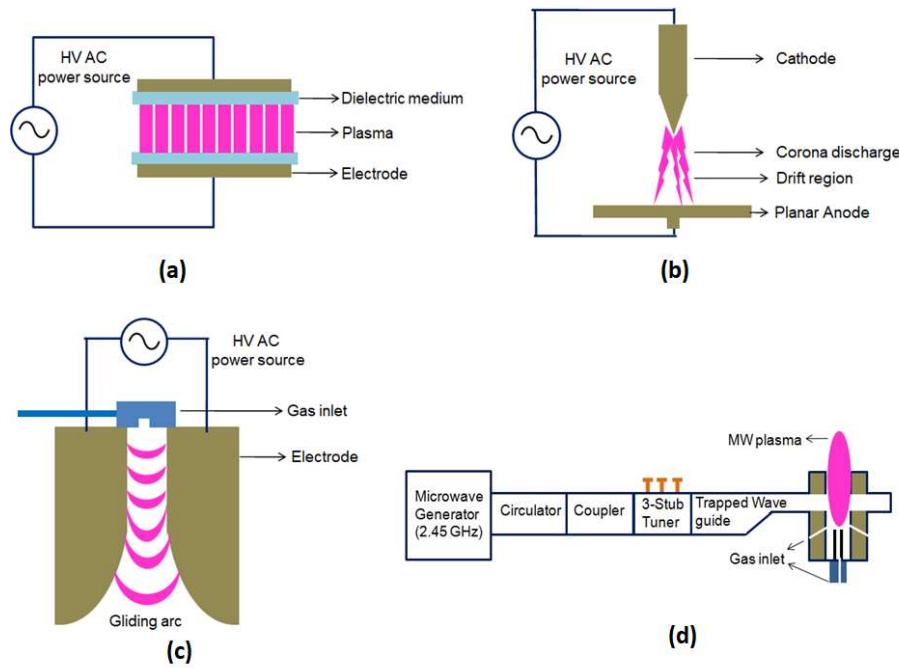

Fig.6. Schematic of different non-thermal plasma discharges: (a) DBD; (b) CD; (c) GAD; (d)MWD.

2.3.5 Arc discharge (AD)

Arc discharge plasma produces thermally equilibrium plasma at atmospheric pressure. The arc discharge provides a high density and high temperature region between the two electrodes and in the presence of sufficiently high gas flow; the plasma can extend beyond one of the electrodes in the form of a plasma jet. Initially, a high voltage is used for initiating the electric breakdown between the electrodes. The plasma generating device is known as the plasma torch or plasmatron, which is designed to heat the gases to high temperatures. The plasma torches are flexible devices due to their working abilities at wide ranges of operating powers (kW to MW) and large combinations of working gases such as argon, nitrogen, air, carbon dioxide etc. There are four different types of plasma torches that are being currently employed for various applications. They are direct current (DC) torch, alternating current (AC) torch, radio frequency (RF) torch and microwave plasma torch (MW). Typically arc plasma operates at high-current (30 A to 30 kA), low-voltage (10-100V) in and around the atmospheric pressure. The temperature of arc plasma is very high (>10000 K) and the temperature of the ions and electrons are nearly equal. Due to this property, arc plasma is widely used in various industrial applications especially in metallurgy [57, 58], waste disposal [54, 55] and gasification [35]. Fig.7 represents the schematic of conventional DC non-transferred arc plasma torch.

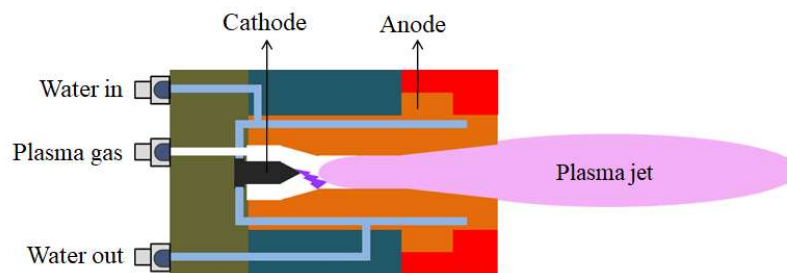

Fig. 7. Schematic of conventional DC non-transferred arc plasma torch.

Table.3. Properties of different plasma sources

Plasma properties	DBD	Corona	Gliding arc	Micro wave	Arc
Electron energy (eV)	1-30	~ 5	1.4-2.1	-	1-10
Electron density (cm ⁻³)	10 ¹² -10 ¹⁵	10 ⁹ -10 ¹³	10 ¹⁴ -10 ¹⁵	Up to 10 ²⁰	10 ¹⁵ -10 ¹⁹
Current (A)	1-50	~10 ⁻⁵	0.1-50	-	50-500
Gas temperature (K)	300-500	~400	1000-3000	2000-6000	10000-30000
Break down voltage (kV)	5-25	10-50	0.5 - 4	-	10-100

3. Decomposition of carbon dioxide (CO₂)

Carbon dioxide (CO₂) makes a major contribution towards global warming and it also participates in ozone depletion reaction [93, 3]. It causes global climatic changes and extremely influences environmental issues. The industries, automobiles, agriculture and household works are the major sources of CO₂ emission. Worldwide emission of CO₂ is about 30 billion tons per year. The gradual increase of CO₂ in the atmosphere has become the major concern of the world from the last few decades [4]. The increase of CO₂ emissions demands effective methods to reduce the CO₂ concentration in the atmosphere. The decomposition or conversion of CO₂ is the main agenda to mitigate the CO₂ emissions [94]. Concurrently, CO₂ has a very good application potential to generate alternate fuels. It can be converted into new chemicals and can also be used as feedstock for alternative fuels. The conversion of CO₂ into valuable products reduces the presence of CO₂ in the atmosphere and as well as fulfills the demand for fuels and chemicals. However, conversion of CO₂ into value added chemicals and liquid fuels is one of the major challenges of this century. Recently, various scientific groups are focused on converting CO₂ and utilizing its valuable products; subsequently leading to the framework of sustainable and green chemistry [11,12]. In the recent years, plasma assisted decomposition of CO₂ has drawn immense attention along with the electro-chemical, biological reduction and catalytic conversion process.

The decomposition of CO₂ is the initial step in the CO₂ utilization process. Formation of carbon monoxide (CO) and oxygen (O₂) are the main products during the splitting. The CO₂ molecule is stable and strongly bonded, hence the decomposition is highly endothermic by nature.

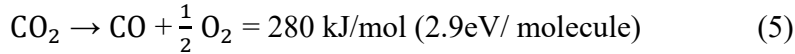

The required thermal energy for CO₂ splitting should be supplied from external energy sources like fossil fuels, electricity, etc. Thermodynamic calculations predict that the required temperatures to break the chemical bond and complete decomposition into a carbon (C) and oxygen (O) are around 1500 °C and 5000 °C respectively. The conversion and energy efficiency are the main parameters used to observe the effectiveness of the CO₂ utilization. Conversion measures how effectively the process can convert the supplied CO₂. Energy efficiency represents how efficiently the input energy converts into chemical energy.

During the past two decades, several plasma enhanced CO₂ decomposition systems have been developed by using plasma sources like DBD [95, 96], Microwave, [97, 98, 99, 100, 101] gliding arc [102] and thermal plasma sources [103]. Fig. 8 shows the schematic view of CO₂ decomposition using plasma medium.

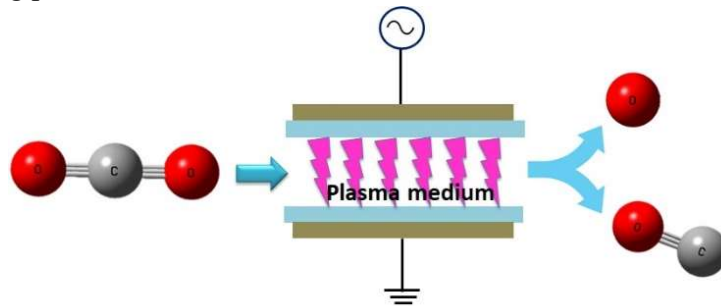

Fig.8. Schematic view of plasma assisted CO₂ decomposition

DBD plasma is the most popular plasma source at atmospheric pressure and it is effectively used for the decomposition of the CO₂. Many notable works have been reported in this area but detailed studies of energy efficiency and conversion rates are limited. Most of the studies are concentrated on the influence of the operating parameters on the decomposition of CO₂ [95, 96, 104, 105]. DBD reactors with different geometries have been developed for this application, particularly, coaxial type DBD is the most favorable choice of reactor for gas decomposition [95, 96]. Numerous studies have been carried out by using DBD plasma for achieving higher percentage of CO₂ conversion with higher energy efficiency by changing the parameters such as applied power, gas flow rate, discharge frequency, discharge dimension, reactor temperature, electrode and dielectric material, catalytic materials, secondary gases (Ar, He, N₂) and their mixing ratios.

Paulussen et al. used tubular DBD reactor to study the effect of gas flow rate, discharge power, frequency and reactor temperature on the decomposition of CO₂ [96]. The experiments were conducted at two different gas flow rates (0.05 and 0.5 slpm) with wide ranges of frequency (10 to 90 kHz). Maximum conversion of 30% was achieved in low gas flow rate (0.05 slpm) at the power density of 14.75Wcm⁻³. It was found that the gas flow rate has a strong influence on the conversion and CO yield followed by discharge power and gas temperature.

Aerts et al. used a simple co-axial type DBD reactor for CO₂ decomposition at atmospheric pressure [95]. Operating parameters such as applied input power, gas flow rate, frequency, dielectric material and discharge gap was varied and their role in the CO₂ conversion and energy efficiency was studied in detail. They observed that the applied frequency and electric field did not have significant influence on the conversion and energy efficiency whereas the discharge gap and gas flow rate had a significance effect on both. Maximum of 35% CO₂ conversion was obtained at a high specific energy input (above 200 J cm⁻³), which corresponds to a low energy efficiency of only 2%. The selectivity of CO and O₂ were found to be around 50% under all the conditions. The specific energy input (SEI) is one of the important factors that correlates the conversion rate and energy efficiency. It was found that the conversion increased with increasing SEI and energy efficiency decreased with increasing SEI.

The nature of dielectric material in a DBD reactor can change the conversion rate significantly. Yu et al. investigated the decomposition of CO₂ in a dielectric packed bed reactor [104]. The packing dielectric material was commercial silica gel, alumina (γ -Al₂O₃, and α -Al₂O₃), quartz and calcium titanate (CaTiO₃). A high voltage (0-30V), high-frequency AC power source was used to generate the plasma in the reactor. Different discharge length and input power were used in the experiments. It was observed that the dielectric packing material in the DBD reactor enhanced the conversion rate from 11 to 20 %. Li et al. prepared high permittivity Ca_{0.7}Sr_{0.3}TiO₃ dielectric material by liquid phase sintering and used it for decomposition of CO₂ through plasma medium [106]. The obtained results were compared with conventional dielectric materials such as Al₂O₃ and SiO₂. By virtue of the high value of permittivity and high dielectric strength of Ca_{0.7}Sr_{0.3}TiO₃, much denser and numerous micro-discharges were produced than in the case of Al₂O₃ or SiO₂. The maximum conversion reported when Ca_{0.7}Sr_{0.3}TiO₃ was used as the dielectric barrier was 15.6%, whereas Al₂O₃ and SiO₂ dielectrics gave conversion of 4.7% and 3.8% respectively. Tagawa et al. developed a hybrid reactor by integrating DBD and solid oxide electrolyzer cell (SOEC) for enhancing the efficiency of CO₂ decomposition [107]. The SOEC made of yttria-stabilized zirconia tube with lanthanum strontium manganite thin film (acting as electrodes), was inserted into a quartz tube. CO₂ was supplied between the quartz tube and SOEC where the DBD plasma was formed. The maximum conversion rate was around 40 % while using DBD and SOEC independently. Meantime, the combined operation of DBD and SOEC increased the conversion rate up to 80%. On other hand, Belov et al. observed that the surface conductivity of the dielectric walls on the DBD reactor affects the electrical current profiles and it can greatly influence the CO₂ conversion [108].

In terms of energy efficiency, microwave plasma has been recognized as the most favorable tool for CO₂ dissociation [109, 110]. It is generally assumed that this is due to a low reduced electric field and the accompanying preferential vibrational excitation of CO₂ molecules [110, 111, 112, 113]. Vesel et al. measured the dissociation fraction of CO₂ in microwave plasma discharge and found that the dissociation rate decreased with decreasing discharge power. The maximum dissociation rate was 13% at a pressure of 20 Pa [114].

Savinov et al. studied the decomposition of CO₂ using capacitive RF plasma in moderate range of pressures 5-60 Torr [101]. Fig.9. shows the schematic of the experimental setup used for this study. The results showed that the decomposition of CO₂ molecules was caused by direct electron collision via excitation of the unstable electronic state. The energy costs for decomposition of one molecule of CO₂ was determined as 130 ± 15 eV/ mol.

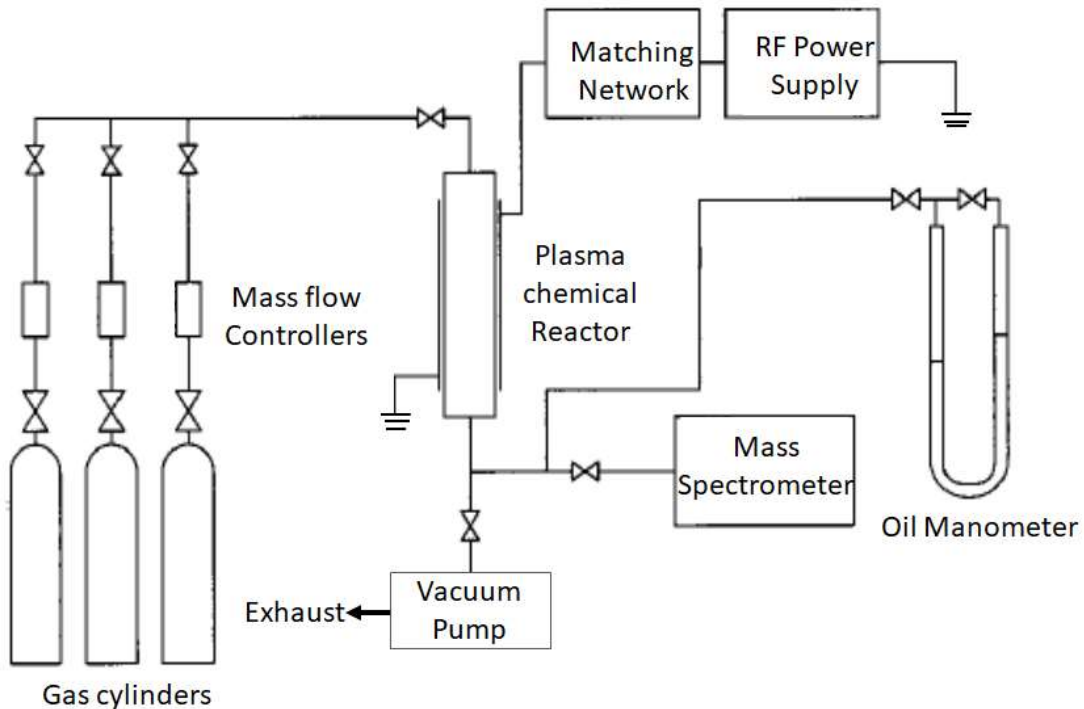

Fig.9. Schematic of the plasma assisted CO₂ decomposition system used by Savinov et al. [101].

Buser and Sullovan used glow discharge to reduce the concentration of CO₂ [100]. The authors studied the dissociation rates of pure CO₂ and the mixture of CO₂ with H₂, He and N₂, in 1 Torr pressure range. It was found that H₂ gas mixtures are most influential in slowing down the initial CO₂ decay rate and as well as in reducing the steady-state dissociation.

CO₂ vibration levels are more important for energy efficient conversion. Heijkers et al. developed a computer model for studying the effect of N₂ on the CO₂ conversion in a microwave discharge plasma [115]. They calculated the conversion and energy efficiency of CO₂ for different power densities (30-80 Wcm⁻³) and N₂ fractions in the gas mixture (0-90%). The absolute CO₂ conversion was found to be in the order of 10-80%, rising with power density and with N₂ fraction. Their results show that the introduction of N₂ is beneficial for energy conversion.

Wang et al. used a glow discharge plasma in a tubular reactor for CO₂ decomposition at atmospheric pressure [99]. They studied the influence of concentrations and flow rate of the flow gas, discharge power, frequency and filled metal on the conversion of CO₂ and energy efficiency. They found that the initial excitation voltage to produce the plasma is independent of the metal identity on the surface of the electrode and the flow rate of CO₂ containing gas but dependent on

the CO₂ concentration and frequency used. High concentration of CO₂ and high discharge frequency is more favorable to obtain high reaction rates and high energy efficiencies.

Corona discharge is another efficient tool for decomposition of CO₂. Maezono and Chang used two small size cylindrical hollow electrodes to produce corona discharge for reducing the concentration of CO₂ [98]. The gas flow rates and discharge current throughout the experiment was 0 to 3 lpm and 0 to 4 mA respectively. The gas mixing ratio of argon was varied from 0 to 70% and percentage of gas mixing of CO₂ from 0 to 10%. Experimental results showed that discharge current has an impact on the decomposition of CO₂ and formation of CO. The decomposition of CO₂ and formation of CO increased with increasing discharge current. During the decomposition CO₂ gas is mainly converted as CO and O.

On other hand, thermal plasma is also an efficient tool for decomposition of CO₂ in bulk volume. Kobayashi et al. used thermal plasma torch for the treatment of the CO₂ gas [103]. Authors found that thermal efficiency of the plasma torch increased with increase in input power and the maximum thermal efficiency achieved was 80%. Due to the high power of the plasma, complete decomposition of CO₂ to pure carbon and oxygen was accomplished.

4. Decomposition or conversion of methane (CH₄)

Methane (CH₄) is the second largest greenhouse gas responsible for global warming. The global warming potential (GWP) of CH₄ is 25 times greater than CO₂. Manmade activities such as petrochemicals, mining and natural decomposition of organic compounds are the major sources of CH₄. CH₄ is the principal component of natural gas and an abundant source of energy. Natural gas is the one of the cheapest energy sources and it is the major source of electricity throughout the globe. The conversion of CH₄ and CO₂ can produce valuable chemicals and liquid fuels, such as hydrogen gas, syngas, methanol, higher hydrocarbons, formaldehyde etc. Viewing from these aspects CH₄ is an important feedstock for power production. The utilization of CH₄ eventually reduces the emission of CH₄ in the atmosphere and also acts as an alternate source of energy.

CH₄ can be directly used for the production of electricity or it can be used for the production of syngas. CH₄ is a very stable compound. The conversion of CH₄ into energy sources and value-added chemicals is still complicated [116, 117, 118]. Various methods are being used for the transformation of methane into syngas that includes steam reforming of methane (SRM), partial oxidation of methane (POM) and dry reforming of methane (DRM). Steam reforming of methane (SRM) is a commercialized technique to produce syngas by reaction of CH₄ with water.

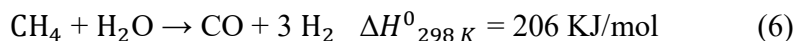

It is an endothermic reaction that needs higher temperatures (~ 700⁰ C) to activate the reforming reaction [119, 120, 121, 122, 123]. Partial oxidation of methane (POM) is an exothermic reaction and the reaction is possible at relatively lower temperatures (300-500 °C). The energy consumption

is low in this method. It is crucial to control the ratio of O₂/CH₄ in this POM, otherwise it may lead to full oxidation and generate CO₂ and overheat the reaction bed [124, 125, 126, 127].

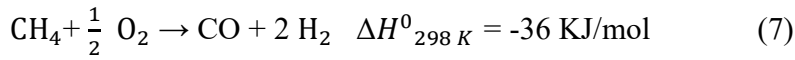

Integration of SRM and POM in a single process is called a hybrid reforming system which can be a promising approach for effective conversion of CH₄ with zero net entropy. Here, the heat released during POM can be used to activate SRM, hence the energy utilization efficiency is relatively higher in this process. This hybrid system also named as auto-thermal reforming of CH₄ (ATR). However, ATR is quite complex than other processes due to overheating [128, 129, 130].

Dry reforming of methane (DRM) is another promising approach for converting CH₄ and CO₂ into syngas [131, 132, 133, 134, 135].



DRM is a highly endothermic reaction. Theoretical studies state that conversion rate of CH₄ and CO₂ are respectively 41% and 55% at 600 °C [136]. Meantime, the presence of catalysts made of noble and transition metals has significantly reduced the conversion temperature or enhanced the conversion rate [137, 138, 139, 140, 141, 142, 143]. For example, while using Pt-Ni/ZSM-5 catalyst, the conversion rate of CH₄ and CO₂ are 53.8% and 98.5% respectively at 600 °C [22] which is higher than the theoretical value. Naturally abundant transition metals such as Fe, Ni and Co are widely used for the DRM process although their conversion efficiency is not substantial like noble metals [144, 145, 146, 147, 148]. Catalytic method of DRM is restricted in its industrial application due to its low energy efficiency, high operating temperature (700-1000⁰ C) to activate and break the C-H bond of CH₄ molecule. The catalyst deactivation caused by carbon deposition on the catalyst surface is another major barrier in this process [149].

Recently, plasma methods have been widely employed for CH₄ conversion [150, 42, 43, 44, 151, 152, 44, 153, 154, 155, 156, 157, 158, 159, 160, 101]. Non-thermal plasma is widely used for the conversion of CH₄ due to its unique properties [161, 80, 143]. The high temperature is the major advantage of the thermal plasma, thus it can dissociate CH₄ and CO₂ spontaneously. The reported results shows that conversion rate is 80% and the carbon deposition is suppressed [162, 35] in thermal plasma assisted dry CH₄ reformation. The major advantage of the plasma technology is that different plasma sources and its wide operating parameters can produce different product distribution. Conversion of CH₄ using dielectric barrier discharge (DBD) [163,164,165, 166,167,168,154], Radio frequency plasma [169, 170], corona [171,172] gliding arc and thermal plasma [173,174] have also received wide attention. Schematic view of plasma based syngas production by dry reformation of greenhouse gases is shown in Fig.10.

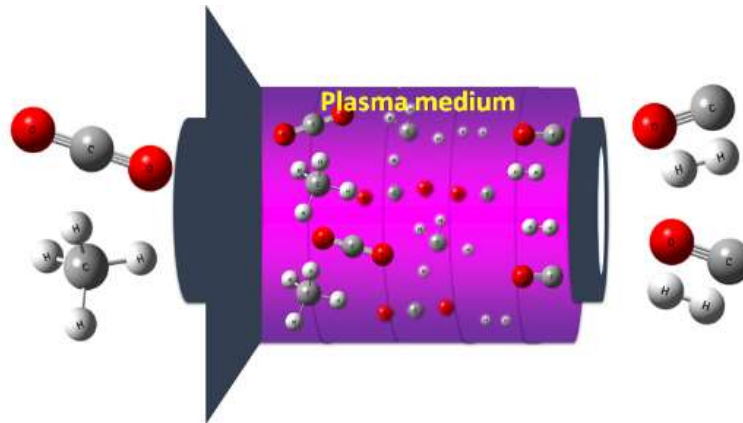
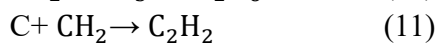
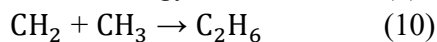
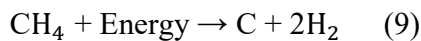

Fig.10. Schematic of plasma-based syngas production by dry reformation of greenhouse gases.

Generally, thermal plasma converts CH_4 mainly into C and H_2 [175]. Non-thermal plasma assisted conversion of methane produces higher hydro carbons such as acetylene and ethane through the coupling reactions of methyl radicals or carbon with methyl radical [176].



Non-thermal plasma sources are considered as an appropriate alternative for the catalyst assisted CH_4 reformation process due to their high chemical selectivity, low temperature and low investment. Particularly, DBD plasma has caught the eye than other non-thermal plasma sources. The application of high voltage creates an intense electric field where the charged particles accelerate and collide with the gas molecules thus creating excited species, such as electrons, radicals, ions and excited molecules.

Zhou et al. conducted experiments and numerical simulations for the conversion of CH_4 and CO_2 into syngas using DBD at low temperature and pressure. [177]. Influence of operating parameters such as discharge power, flow rate and mixing ratio, pressure and temperature on the conversion were evaluated in detail. It was observed that the syngas production was strongly dependent on the input power and gas mixing ratio. The maximum conversion of CH_4 and CO_2 that could be obtained were 64%, and 54% respectively. Higher amount of H_2 (52 mole) and CO (14 mole) was obtained at a specific input energy of $87 \text{ kW h}/(\text{N m}^3)$. Authors suggest that low pressure is suitable for synthesis gas formation. Gesser et al. converted CH_4 and CO_2 by using DBD reactor in series (two) and they achieved conversions up to 50% at the applied voltage of 13 kV with 25 mA of discharge current [178].

The input power has a huge impact on the conversion and selectivity of the CH_4 and CO_2 . Liu et al. converted CH_4 into hydrocarbons using dielectric barrier discharge. The major products were syngas, acetylene, ethylene, propylene, liquid hydrocarbons etc [179]. The feed gas ratio and applied power was found to influence the product distribution and selectivity. Further it was

observed that increase in applied power increased the H₂/CO ratio in the syngas. The higher CH₄/CO₂ feed ratio was observed to lead to a higher selectivity of C₂ and C₃ hydrocarbons. With an input power of 40W and a large excess of methane (CH₄/CO₂= 6.5) the hydrocarbons selectivity from C₂ to C₄ reached 62%, while ethane was mostly formed with a selectivity of 23% [180]. Wang et al. used coaxial dielectric barrier discharge reactor to investigate the influence of the input power on the conversion of CH₄ and CO₂ [27]. They observed that the major product was syngas along with C₂H₆ and other hydrocarbons. The conversion and selectivity increased with increasing input power. Maximum conversions of CH₄ (72.8 %) and CO₂ (44.4%) were obtained at an input power of 107.4 W with the discharge gap of 1.95 mm, electrode length of 20 cm, total feed flux of 0.02 lpm and 1:1 mole ratio of CH₄/CO₂. The selectivity of CO, H₂ and C₂H₆ was about 82%, 70% and 8.8%, respectively.

Legrand et al. investigated the conversion of CH₄ along with N₂ gas by using DBD [171,181]. It was observed that the reactions were initiated by the excited nitrogen compounds and increasing the power could increase the electron density inside the reactor, thus enhancing the conversion rate. Movement of electron is much faster than ion and radicals in the reactor and the electron plays a dominant role in the reforming reactions [182]. The dilution of CH₄ and CO₂ by He gas plays a vital role in the reactant transformation under non-thermal plasma. At a fixed specific energy input, the conversions of CH₄ and CO₂ increased significantly from 10 to 20% and 7 to 16% respectively when the dilution ratio of the mixture was increased from 0 to 80 vol% [183]. It can be explained by the “penning ionization” phenomenon corresponding to an energy transfer from excited species to atom or molecule in ground state [184]. The pulsed form of an applied voltage has a moderate impact on the conversion of CH₄ and CO₂. Song et al. investigated the effect of pulse form of applied voltage on the conversion and product selectivity of CH₄/CO₂ conversion using cylindrical dielectric barrier discharge [185]. They used AC power supply with a high-frequency sinusoidal wave form and AC pulse wave form for their studies and found that the pulse width of pulse power supply was not effective in enhancing the conversion. Meantime, long pulses were found to increase the power consumption.

Lee et al. used AC DBD, pulsed DBD, AC spark, rotating arc, gliding arc and hollow cathode plasma sources and compared their characteristic conversion of CH₄. Reactions were optimized by determining the yield of H₂, C₂H₆, C₆H and C₂H₂ at constant flow rate of CH₄ [186]. The experimental set up is the same except for the plasma source. Comparative results revealed that AC spark, hollow cathode plasma and rotating arc show higher degree of temperature than other plasma sources thereby aiding the achievement of higher conversion and selectivity of H₂ and C₂H₂. The plasma characteristics such as electron energy and temperature have a direct influence on the selectivity of the process, thus implying that proper selection of the plasma source can play a vital role in controlling the reaction.

Microwave plasma is another type of plasma source which is widely used for CH₄ reformation. DRM by microwave plasma sources offers bulk amount of treatment with higher energy efficiency, higher conversions and selectivity. Zhang et al. used pulsed microwave plasma (frequency: 2450 MHz) for the conversion of CH₄ with CO₂ at atmospheric pressure [187]. It was

found that by changing the ratio of CH_4/CO_2 it is possible to change the H_2/CO ratio and selectivity of CO and C_2 . The energy efficiency of the conversion increased while increasing the input power of the microwave discharge. Maximum conversion of CH_4 and CO_2 were 70.8% and 68.8%, respectively. The selectivity of CO , C_2H_2 , and C_2H_4 were 75%, 17.8%, and 4.1% respectively. The lack of carbon deposition is another major advantage of this method. Chun et al. [188] converted CH_4 and CO_2 into syngas using atmospheric pressure microwave plasma torch at 6 kW input power and 30 slpm of total gas flow rate. The CH_4/CO_2 mole ratio was kept at 1:1 throughout the experiment. The temperature of the microwave plasma was measured by optical emission spectroscopy and was found to be 6760 K. The conversion of CO_2 and CH_4 are 68.4% and 96.8% respectively. Observation shows that this method is more efficient than most of the DBD processes [189].

Atmospheric pressure gliding arc discharge (GAD) plasma is another effective tool for DRM due to its large gas flow capacity and high electron energy [190]. Fig.11 shows the schematic of the gliding arc discharge plasma reactor for DRM used by Stryczewska et al. [191].

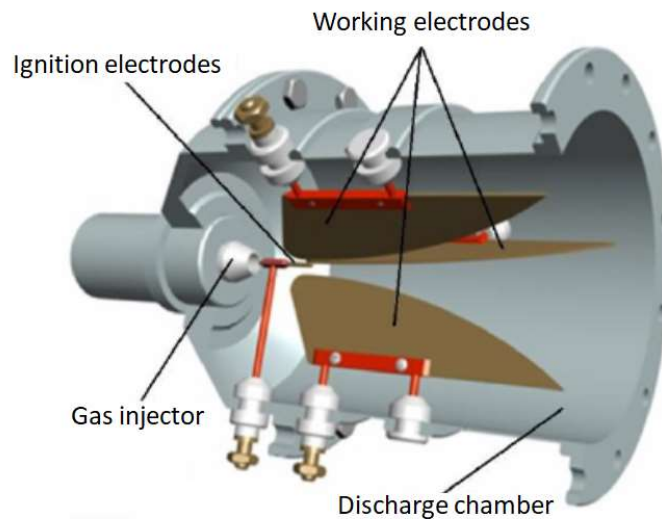

Fig.11. Gliding arc discharge plasma reactor for dry reformation of methane used by stryczewska et al. [191].

GAD plasma can produce thermal equilibrium state and thermal non-equilibrium state in one cycle, thus gives high productivity and good selectivity in most of the reforming processes [192,193, 194]. Hu et al. used GAD plasma for the conversion of CH_4 into C_2 hydrocarbons and H_2 gas at atmospheric pressure in the presence of Ar additive gas [195]. The major operating parameters such as input voltage, CH_4/Ar mole ratio, CH_4 flow rate and electrode gap on CH_4 conversion rate, product distribution, energy consumption, carbon deposit and reaction stability were studied. Authors found that the presence of additive gas increased the conversion and the maximum CH_4 conversion rate obtained was 43.39 % at CH_4/Ar mole ratio of 0.27, CH_4 flow rate of 14 mlpm and input voltage of 22 V.

Indarto et al. studied the influence of additive gases such as He, Ar, N₂, and CO₂ on CH₄ reformation in a gliding arc plasma at atmospheric pressure [196]. They found that diluent gases such as Ar, He, and N₂ enhance the CH₄ conversion rate and reduce the power consumption. Maximum conversion efficiency reaches 65% when 10% of CH₄ is diluted with 90% of Ar or He gas under optimum conditions. Further, an increase in the diluent gas concentration produces higher selectivity of H₂ and reduces the selectivity of C₂H₂.

Wu et al. studied the CH₄/CO₂ reforming process in a rotating gliding arc discharge co-driven by a tangential gas flow and a magnetic field [197]. Optical emission spectroscopy was used to classify the intermediate species and to measure the basic characteristics of CH₄/CO₂ discharge. They found that the increase in applied voltage increased the conversions of CH₄ and CO₂ whereas an increase of the CH₄/CO₂ ratio decreased the conversion. Under the optimum conditions (10 kV; 3/2 mole ratio of CH₄/CO₂, H₂ selectivity reached its maximum value (40%). In addition, well-graphitized carbon structure formation was identified in this process. Lists of the non-thermal plasma based CH₄/CO₂ conversion processes displayed in Table 4.

Bo et al. studied about the influence of CH₄/CO₂ proportion on the performance of dry CH₄ reformation in a gliding arc discharge at different discharge voltages [198]. The experiments were conducted by varying the molar ratio of CH₄/CO₂ (1:2, 1:1 and 2:1) at a fixed gas flow rate (12.7 slpm). The major products of this reaction were synthesis gas with C₂H₄, C₂H₂, CO and H₂. The increase of CH₄/CO₂ molar ratio increased the conversion rates of CH₄ and CO₂ with subsequent formation of main by-products such as C₂H₂ and C₂H₄. Further, the selectivity of H₂ increased and selectivity of CO decreased with respect to increase in molar ratio. Conversion rate of CH₄ and CO₂ increased with increasing the discharge voltage irrespective of the CH₄/CO₂ molar ratio. Formation of carbon over the electrode surface was increased while the molar ratio of CH₄/CO₂ was greater than 2:1 at higher voltages. It was found that the energy consumption for their dry reforming of CH₄ (3.2–21.2 eV/molecule) is lower than that of pulsed DBD (38–57 eV/molecule), AC DBD (116–175 eV/molecule) and pulsed spark discharge (14–25 eV/molecule) [199].

Lately, plasma assisted catalytic dry reformation of CH₄ has been widely focused due to integrated advantages of both plasma and catalyst. Bouchoul et al. used La₂O₃, α -Al₂O₃, γ -Al₂O₃, TiO₂, CeO₂, BaO, ZnO, CaO, and MgO as the catalytic materials for plasma assisted catalytic dry reformation [200]. The experiments were conducted in coaxial DBD reactor at a fixed discharge power of 8 Watts with He gas atmosphere. Results revealed that γ -Al₂O₃ produced maximum conversion of CH₄ (30.6%) and CO₂ (16.1%), whereas in the case of TiO₂, the conversions of CH₄ and CO₂ were 5.6% and 1.9% respectively. The selectivity towards CO and carbon balance was the highest with CaO, La₂O₃ and MgO. The detailed study about the MgO catalyst reveals that increase of temperature increased the CH₄ conversion along with reduction in methanol selectivity.

Goujard et al. used pulsed DBD reactor and perovskite LaNiO₃ as a catalytic material for the conversion of the mixture of CH₄/CO₂ with a molar ratio of 6:4 (biogas) at different reaction temperatures [201]. They observed that syngas was the main product along with C₂H₂, C₂H₄, C₂H₆, C₃H₈ and traceable amounts of C₄ to C₆, and oxygenate compounds. The conversion of CH₄ and

CO₂ increased with respect to the reaction temperature. At 673 K, the selectivity of light hydrocarbons was found to be maximum. The reaction between the cracked carbon and active oxygen was promoted at higher temperature (>373 K), thus favoring the formation of CO. The results showed that the coupling of catalyst with plasma enables CO₂ molecules activation and influences the product selectivity.

Jiang et al. investigated CH₄ conversion into syngas, light hydro carbons and fuels in cylindrical DBD plasma coupled with zeolite [202]. They found that the increasing gas flow rate increased the selectivity of C₂ and decreased the selectivity of C₅ hydrocarbon. Meantime, flow rate does not have a significant influence on the yield of C₂–C₄ hydrocarbons. Presence of zeolite reduced the formation of carbon black and leads to a higher selectivity of light hydrocarbons (C₂–C₄). The yield of CO, H₂ and other higher hydrocarbons increased with the increasing discharge plasma power and decreased with high flow rate of feedstock gases. Interestingly, authors found that the conversion of CH₄ and CO₂ decreased while the reactor wall temperature increased from 50 to 150 °C. Song et al. used Ni/γ-Al₂O₃ as the catalyst in a DBD plasma reactor for CH₄ reforming and found that CO, H₂, C₂H₆, C₃H₈ and C₄H₁₀ are the resultant products while feeding equal mole ratio of CH₄/CO₂ [203]. The presence of catalyst increased the conversion of CO₂ from 30.95% to 33.48% at the discharge power of 130 Watts with the flow rate of 0.03 lpm.

Compared to non-thermal plasma, thermal plasma offers significant advantages such as high temperature, high energy density, intense active species and bulk reforming capacity. This in turn leads to higher conversion rate with good selectivity and less by-product formation which are the primary concerns while scaling-up the process to industrial level. Tao et al. used thermal plasma reactor for reforming of CH₄/CO₂ with and without the presence of catalyst [35]. Commercial Ni/Al₂O₃ catalyst was used in the experiment. Thermal plasma was generated at 9.6 kW power with N₂ gas. Mixture of CO₂ and CH₄ with 4:6 molar ratio was injected into the plasma jet at different feed rates in order to study the effect of total flux of feed gases on the conversion and selectivity of the product. Conversions of CH₄ and CO₂ reached a maximum of 92.32% and 82.19%, respectively. Selectivity of CO and H₂ were 90.05% and 75.43%, respectively. The results revealed that the conversion and selectivity and the specific energy of the reforming reaction were impressive by the nature of thermal plasma. Moreover, specific energy input in plasma with catalysts was also high, it reached its maximum value of 2.3mmol/kJ at 2.2m³/h. From the observed results it is evident that thermal plasma assisted reforming has the potential to be scaled-up when compared to the non-thermal plasma sources.

The same research group developed [175] a novel thermal plasma torch with two anode configurations (binode thermal plasma torch) for CH₄/CO₂ reformation. The binode thermal plasma generator consists of a club-shaped cathode and two columnar anodes which are separated by an insulating material. A mixture of Ar/CH₄/CO₂ were used as the plasma forming gases. Fig.12. shows the schematic of the binode plasma processing system which is used reformation.

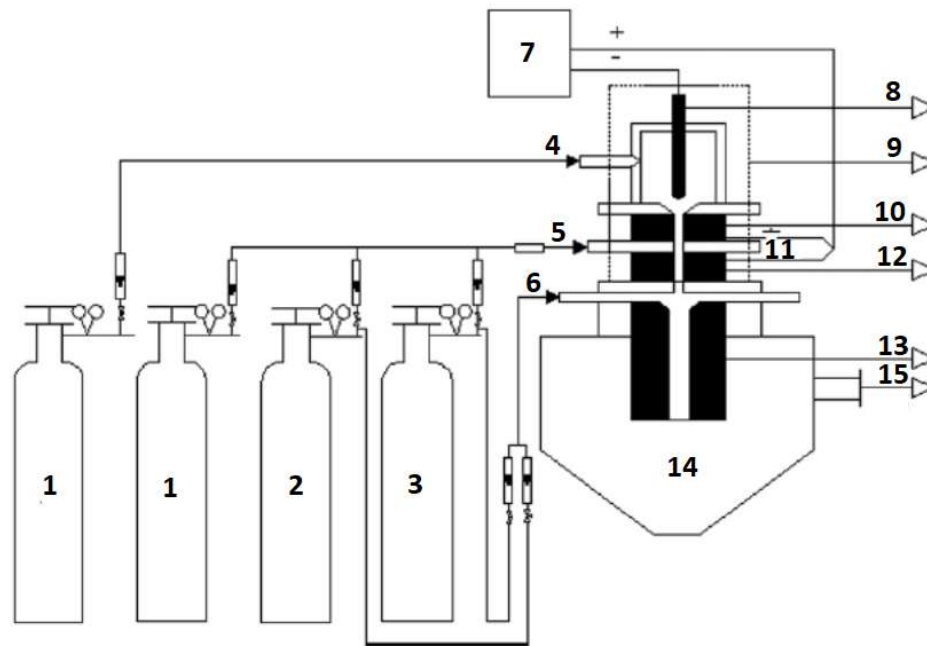

Fig. 12. Thermal plasma processing system. 1. Ar, 2. CH₄, 3 CO₂, 4. Gas inlet I, 5. Gas inlet II, 6. Gas inlet III, 7. DC power supply, 8. Cathode, 9. Plasma generator, 10. First anode, 11. Contactor, 12. Second anode, 13. Graphite tube reactor, 14. Collector, 15. Gas outlet [174].

Experiments were conducted in the following two different modes: 1) Mixture of feed gases Ar/CH₄/CO₂) were directly introduced into the discharge region between the first anode and the second anode as the plasma forming gas. 2) Mixture of feed gases was partially introduced into the plasma jet from the exit of the plasma generator. The experiment conducted in the second mode achieved a higher energy conversion rate than the first mode because the introduction of the mixture of CH₄ and CO₂ as the plasma forming gas in the plasma discharge region changes the arc voltage with respect to the gas flow rate. The higher energy efficiency (57.22%) could be achieved when the plasma discharge power was 18 kW, the feed gas flow into inlet II was 2.4 m³/h and feed gas flow into inlet III was 2.0 m³/h.

Lan et al. studied CH₄/CO₂ reforming by a single-anode hydrogen thermal plasma jet operated at 8.5 kW input power with the gas flow rate of 1.3 m³/h. Mixture of CH₄/CO₂ gas with 4/6 mole ratio was fed into the plasma jet and the maximum conversions of CH₄ and CO₂ obtained were 87.98% and 84.34%, respectively [162].

Table 4. CH₄/CO₂ conversion through non-thermal plasma reactor

Feed gas ratio	Plasma reactor	Plasma Temperature [K]	SEI [kJ/mol]	Conversion [%]	Products selectivity [%]	Reference
5% CH ₄ , 95% N ₂	DBD AC	500	1094.4	CH ₄ – 14.8%	C ₂ H ₆ (10.6%) C ₂ H ₄ (0.7%) C ₂ H ₂ (0.8%)	[204]

5% CH ₄ , 95% N ₂	DBD pulsed	500	224.64	CH ₄ – 12.4%	C-3 (2%) C ₂ H ₆ (6.5%) C ₂ H ₄ (0.3%) C ₂ H ₂ (0.3%) C-3 (0.9%)	[204]
5% CH ₄ , 95% N ₂	Rotating arc	1000	61.92	CH ₄ – 25.8%	C ₂ H ₆ (0.2%) C ₂ H ₄ (1.1%) C ₂ H ₂ (42%)	[204]
5% CH ₄ , 95% N ₂	Gliding Arc	3000	72	CH ₄ – 23.7%	C ₂ H ₂ (27.2%)	[204]
5% CH ₄ , 95% N ₂	Hollow cathode	2000	28.8	CH ₄ – 42.2%	C ₂ H ₆ (1.4%) C ₂ H ₄ (1.4%) C ₂ H ₂ (27%) C-3 (0.3%)	[204]
21.2% CH ₄ , 78.8% Ar	Gliding Arc		2090	CH ₄ – 43.4%	C-2 (87.2%)	[195]
100% CH ₄	Gliding arc,		273.6	CH ₄ – 47%	C ₂ H ₂ (22%)	[205]
15% CH ₄ , 85% Ar	Gliding arc		165.6	CH ₄ – 65%	C ₂ H ₂ (7%)	[205]
100% CH ₄	Microwave	1500-2500	963.5	CH ₄ – 90%	C ₂ H ₂ (80%)	[206]
100% CH ₄	DBD		4624.9	CH ₄ – 38%	C ₄ H ₁₀ (5%) C ₂ H ₂ (4%)	[207]
50% He, 50% CH ₄	DBD	373	10,350	CH ₄ – 18.4%	C ₂ H ₆ (80.7%) C ₂ H ₄ (6.3%) C ₂ H ₂ (1.3%) C ₃ H ₈ (5.3%) C-4+ (6.5%)	[208]
100% CH ₄	DBD		7372.8	CH ₄ – 10.2%	C ₂ H ₆ (45%) C ₃ H ₈ (20%) C ₂ H ₄ (3%) C ₂ H ₂ (3%) C-4 (10%) C-5+ (12%)	[209]
20% O ₂ , 80% CH ₄	DBD	353	530	CH ₄ – 15%	CH ₃ OH (22%)	[210]
5% CH ₄ , 5% N ₂ O, 90% Ar	DBD	330	1029	CH ₄ – 32.2% N ₂ O – 53.8%	CH ₃ OH (10%) HCHO (25%) C ₂ H ₆ (10%)	[211]
16% CH ₄ , 84% H ₂ O	Capacitive coupled plasma		345.6	CH ₄ – 5%	CH ₃ OH (20%) HCHO (6%) C ₂ H ₆ (19%)	[212]
67.4% CH ₄ , 32.6% CO ₂	DBD	338	3600	CH ₄ – 35% CO ₂ – 20%	Alcohols (5%) Acids (5%) C ₂ H ₆ (19%) C ₃ H ₈ (9.3%) C-4+ (9%)	[213]
66.8% CH ₄ , 33.2% CO ₂	DBD	333	2400	CH ₄ – 64.3% CO ₂ – 43.1%	CH ₃ COOH (5.2%) Propanoic acid (1%) CH ₃ OH (0.3%) C ₂ H ₅ OH (1.8%)	[214]

4.1 Utilization of CO₂ and CH₄ as the plasma forming gases

Mostaghimi et al. developed two novel DC plasma torches (80 kW and 200 kW) which can work stably with CO₂ and CH₄ gas mixture [215]. These torches provide higher plasma enthalpy and higher thermal conductivity than conventional DC plasma torches due to the use of molecular gases. The molecular gases provide high plasma enthalpy and processing rates. The mixture of CO₂/CH₄ gas can provide higher plasma power than argon-based gas mixtures with similar configuration. In addition, the plasma volume is also larger due to the extended recombination region. The low power torch (80 kW) is mostly used for coating deposition and surface treatment and the high-power torch (200 kW) is used for material processing and waste treatment applications. The volumetric ratio of CO₂ to CH₄ has a major role on the plasma plume composition. Pershin et al. studied the effect of the volumetric ratio of CO₂ to CH₄ on the plasma plume composition and the in-flight particle behavior of Ni-alloy powder during spraying [216].

Recently, our group has developed a multi-cathode thermal plasma torch for efficient dry reforming of CH₄/CO₂ gas mixture. The torch is made of three graphite cathodes and a single copper anode which is insulated with the vortex generator. The torch can be operated upto 15 kW input power. Fig.13 shows the operational mode of the multi-cathode plasma torch being operated at two different gas mixing ratios.

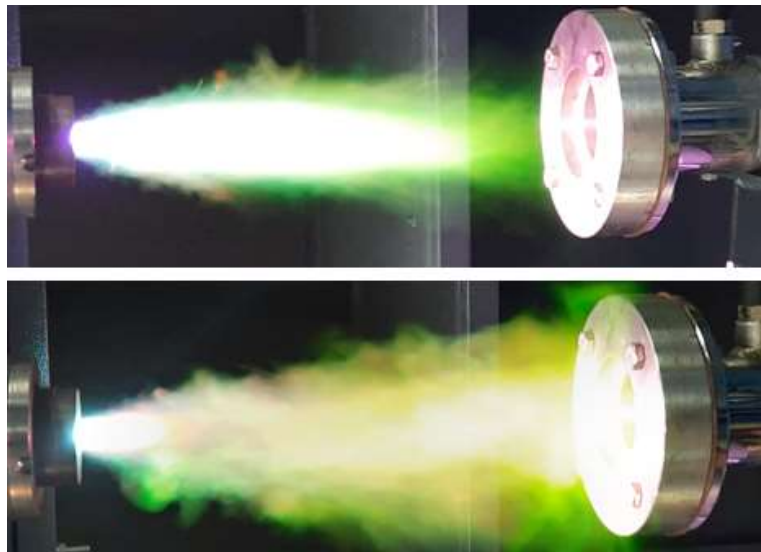

Fig.13. Images of CO₂/CH₄ plasma jet produced by multi-cathode plasma torch at different gas mixing ratios (Pondicherry University)

Soucy et al. used carbonaceous (CO₂/CH₄) plasma torch for the decomposition of sebacic acid in submerged conditions and achieved the highest decomposition rate in a short span of time [217]. High level of UV intensity from the CO₂/CH₄ plasma jet leads to an effective photo-oxidation along with thermal decompositions for this process. Rutberg et al. developed a three phase 120 kW AC plasma torch which works on a mixture of steam with CO₂ and CH₄ (H₂O/CO₂/CH₄). Actual goal for the development of this torch was to produce syngas (H₂/CO) through /CH₄ reforming on an industrial scale [218]. Europlasma has been designing a new generation of

molecular plasma torches powered from 150 kW to 2 MW. These torches can work with any gas mixture composed of CO, H₂, CO₂, CH₄ and N₂; in particular, the torch can be fed with a gas mixture which is recycled from the exhaust gas stream [219]. The performances of these new torches have been studied in the frame of the ULCOS (Ultra Low CO₂ Steelmaking) European program, to reduce the CO₂ emissions of the conventional blast furnace.

5. Decomposition of Nitrous oxide (N₂O)

Nitrous oxide (N₂O) is the third most significant greenhouse gas and the highest ozone-depleting substance [220, 221, 222]. Disproportionate use of nitrogen fertilizers in agriculture, medical exhaust, fossil fuel combustion, chemical industries and wastewater treatment are the important sources of nitrous oxide emission. N₂O is the main cause of photochemical smog, acid rain, depletion of stratospheric ozone and haze. Even though the concentration of N₂O is less its contribution to the greenhouse effect is significant because the GWP of nitrous oxide is 310 times higher than that of CO₂ [223]. Fig.14 shows the graphical image of nitrous oxide decomposition by plasma.

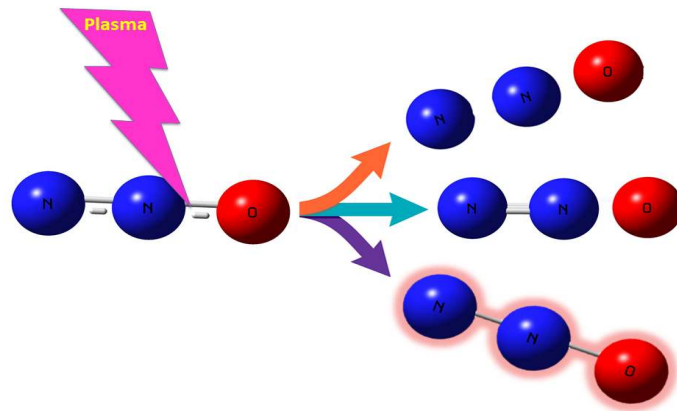
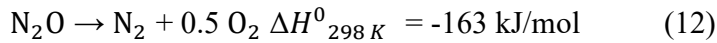

Fig.14. Graphical image of nitrous oxide decomposition by plasma

Various human activities have led to the increase in the level of N₂O concentration in the atmosphere. Different approaches are being used to control N₂O emission in the environment which includes thermal decomposition, catalytic decomposition, oxidation of nitrous oxide to nitric oxide, adsorption, wet scrubbing, masking and biofiltration [224, 225, 226]. Catalytic conversion of N₂O consisting of non-selective catalytic reduction (NSCR), selective catalytic reduction (SCR) and direct catalytic decomposition have been reported by various research groups [220, 222, 223, 224, 227, 228]. However, formation of secondary pollutants such as NO_x poisoning of the catalyst and high process cost are the major drawbacks of the catalytic conversion. Recently, new approaches such as photocatalytic oxidation, electro-chemical oxidation, direct plasma decomposition and plasma-catalytic conversion have been developed for the decomposition of these gases more effectively.

The direct catalytic method has been much explored due to its simple experimental set up and high efficiency. However the high temperature seriously impairs the activity of the catalyst during the N₂O decomposition. The frequent replacement of catalyst increases the experimental cost. These are the major drawbacks of the catalytic method. Among these new methods, the plasma technique has come under limelight due to its unique properties of direct decomposition even at high concentration levels. Combination of plasma and catalytic materials are widely applied for the decomposition of N₂O and volatile organic compounds. The advantage of the plasma-catalyst hybrid method is the initiation of chemical reactions at low temperatures and improved selectivity [22,230,231,232, 233, 234,235].

Generally, N₂O molecule is stable at room temperature. The N-N bond in the N-N-O molecule, is stronger than the N-O bond. During the dissociation of N₂O, N-O bond is the first bond to be broken. The energy required for the bond break of N-O is around 250-270 kJ/mol. Temperature above 900 K is required to initiate the N₂O decomposition. Meantime, direct plasma and plasma assisted catalysis methods are claimed as an efficient method to decompose the N₂O with oxygen free systems at room temperature while using nitrogen or argon as the plasma gases [236,237,238,239,240,241].



Austin and Smith used the glow discharge plasma to decompose N₂O [242]. In this experiment, laboratory grade N₂O (and additives) were allowed to flow through a small (diameter: 1 cm) discharge tube. The result showed that the decomposition of N₂O was predominantly by direct electron impact and that nitric oxide was found to be a significant dissociation fragment.

Mahammadunnisa et al. investigated the influence of operating parameters such as discharge gap, initial flow concentration, residence time, and the effect of packing on the conversion of N₂O in DBD reactor [238]. Three different discharge gap (2.5, 3.5 and 5cm) and dielectric materials (ZrO₂, Al₂O₃ and Glass beads) were used in the experiment. It is observed that the conversion of N₂O reached 100% at 1.6 Watts plasma power with 3.5mm discharge gap. The dielectric packing in the discharge volume enhances the conversion. The ZrO₂ pellets shows better conversion rate compared to other dielectric materials irrespective of discharge power. The authors are recommended that high concentration and low residence time are most favorable for practical applications. Bosi et al. investigated the capability of the gliding arc to decompose N₂O for space craft monopropellant thruster applications [243]. The experiments were conducted at atmospheric pressure. The average voltage and average power of the experiments were 480-1050 V and 13- 34 W respectively. The vibrational temperatures and rotational temperatures were estimated by optical emission spectrum. They developed kinetic model for N₂O decomposition and predicted the influence of gas temperature on the dissociation of N₂O.

Fan et al. investigated the degradation behavior and conversion of N₂O in plasma and plasma-assisted catalytic processes with and without the presence of oxygen atmosphere. The experiments were conducted at room temperature and as well as at high temperature (300⁰C). A coaxial DBD

reactor was used to produce the plasma and $\text{RuO}_2/\text{Al}_2\text{O}_3$ was used as the catalyst. The effect of catalyst, presence of oxygen and its concentration and inlet N_2O concentration on the conversion of N_2O were systematically studied. The authors found that N_2O conversion increased with the increase of discharge power and decreased with the increase of O_2 concentration. The presence of $\text{RuO}_2/\text{Al}_2\text{O}_3$ inside the discharge zone enhanced the conversion of N_2O and improved the selectivity of N_2O decomposition under $\text{N}_2\text{-O}_2$ atmosphere. Results showed that the plasma-assisted catalyst activity led to enhanced decomposition of NO_2 [244].

Lee et al. successfully decomposed N_2O by plasma assisted catalytic method [240]. They used a tubular quartz reactor in which the Ru catalyst was supported on Al pellets. The effects of discharge voltage, space velocity, temperature, and reactant compositions on the N_2O decomposition were studied. The plasma assisted catalyst can break the N_2O bond at low temperatures due to the presence more active radicals. Similarly, Jo et al. investigated the decomposition of N_2O in plasma assisted catalytic method by using $\gamma\text{-Al}_2\text{O}_3$ supported metal oxide catalysts [245]. Among the several catalysts, Al_2O_3 supported Ru was found to be the appropriate catalyst for the decomposition of N_2O in a plasma assisted catalytic reactor. Influence of different operating parameters such as applied voltage, type of catalyst, oxygen content, inlet N_2O concentration, gas flow rate and reaction temperature on the dissociation of N_2O were studied in detail. The studies revealed that, increasing the voltage increased the electron generation and decomposition efficiently. Compared to the catalytic decomposition of N_2O , plasma assisted process improved the decomposition of N_2O by 30-50% depending on the operating parameters.

6. Decomposition of fluorinated gases

The fluorinated gases are considered to have a significant role in the greenhouse effect. Hydrofluorocarbons (HFCs), perfluorocarbons (PFCs) and sulfur hexafluoride (SF_6) are the major fluorinated gases. Fluorinated gases are widely used in the semiconductor industry due to their unique properties such as inertness, heaviness and non-flammability [246]. SF_6 is the prominent fluorinated gas which is the most dangerous greenhouse gas compared to the other fluorinated gases. The global warming potential of SF_6 gas is 23,900. In other words, emission of 1 ton of SF_6 is equivalent to 23,900 tons of CO_2 emission [247]. Further SF_6 has long atmospheric lifetime of about 3200 years. According to the Kyoto protocol [248], SF_6 is among the six most potent greenhouse gases whose emission should be strictly controlled. The octahedral shaped SF_6 is highly symmetric, stable and chemically inert, hence it is quite difficult to disintegrate it thermally or catalytically [249]. Due to its high inertness and high stability, SF_6 is extensively used as an electrical insulator in the power industries [250]. The studies reveal that the emission of SF_6 from power industry will increase through 2030, reaching 64 million metric tons of CO_2 equivalent [251]. Furthermore, the emissions of SF_6 from the semiconductor industries are also steadily increasing due to the large production of the electronic products.

The decomposition of SF_6 is the most suitable way to mitigate SF_6 emissions. In order to reduce the SF_6 level in the atmosphere, recycling is one of widely used technologies in some developed countries. However, this method is not successful in all the parts of the globe due to its high cost.

On other hand, numerous attempts have been tried to synthesise and test an alternative material for SF₆ such as CF₃I/ N₂, CF₃I/CO₂ etc.

So far, several technologies have been used for the decomposition of SF₆, such as thermal decomposition, catalytic decomposition, photo reductive disintegration and plasma assisted decomposition. Thermal decomposition requires higher energy consumption than other decomposition methods. The catalytic decomposition method significantly reduces the operating temperature; however, it requires temperature of around 500–800⁰C for suitable catalytic activity. Moreover, catalytic decomposition produces primary and secondary wastes. Photo disintegration method requires low power consumption than other decomposition methods but it does not have high removal efficiency. Meantime, both the thermal and non-thermal plasma mediums have been successfully utilized for the decomposition of SF₆ with impressive grades. The properties of the non-thermal and thermal plasma have already been described in section 2. The different types of plasma sources such as microwave, corona, dielectric barrier discharge, radio frequency plasma and arc plasma are used for SF₆ decomposition. The reaction kinetics of SF₆ decomposition in plasma medium can be described as follows [252,253]:

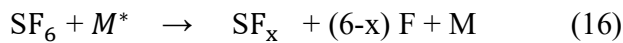
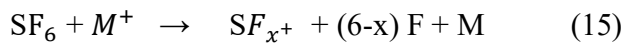
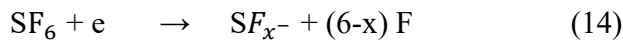
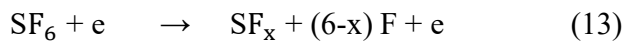

Here M^* and M^+ represent the excited particles and energetic ion, respectively. During the dissociation, the resultant lower fluorides of sulfur rapidly recombine with fluoride to reform SF₆. In order to avoid this issue, concentration of reactive radicals in plasma is increased by adding water vapor and oxygen with the feed gas. The reactive radicals help the lower fluorine sulfides to experience a cascade of chemical reactions to generate the final products as mentioned below [254,255]:

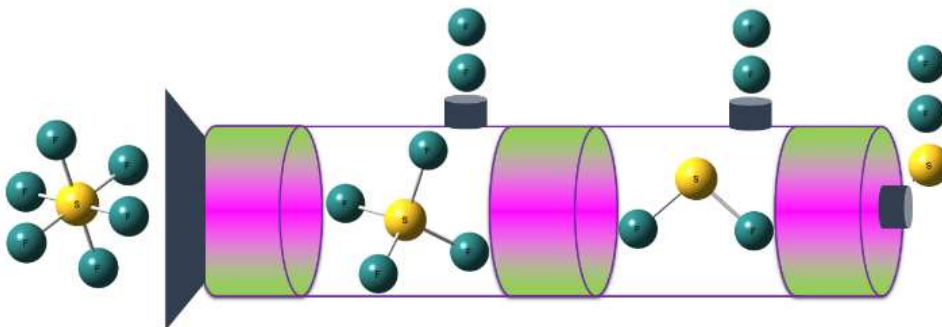

Fig.15. Multistage decomposition of SF₆ by plasma medium

Radio frequency (RF) plasma is widely used for the decomposition of SF₆. Fig.15 represents the multistage decomposition of SF₆ by plasma medium. Shih et al. effectively used RF plasma to decompose SF₆ emitted during the etching process in the semiconductor industry [256]. Ar and O₂/Ar gases were used as the plasma forming gas to decompose SF₆ at a pressure of 9 Torr. The RF plasma was produced by a 13.56 MHz frequency plasma generator and the power ranged from 5-50W. The total gas flow rate was kept as 100 sccm with varied feed ratio of O₂/ SF₆ (from 0 to 2). The SiF₄, SO₂, F₂, SO₂F₂, SOF₂, SOF₄, S₂OF₁₀, S₂O₂F₁₀, and SF₄, were the major products when SF₆ reacted with Ar and Ar/O₂ plasma. The SF₆ removal efficiency and the end products were strongly influenced by the input power. When the input power raised above 40W, SF₆ was converted into stable products such as SF₄, SO₂ and F₂. Meantime, SO₂F₂, SOF₂ and SOF₄ were generated only when the input power was below 40 W. The reported removal rate was 99% in this process. The same group used H₂S as the reducing agent to decompose SF₆ in a RF plasma system. Besides effectively reducing SF₆, the problem of H₂S disposal is also solved. The operating pressure of the system was 10 Torr and the H₂S/SF₆ feed ratio was varied between 0.0 and 9.9. The removal efficiency of SF₆ and H₂S exceeded 99% at the discharge power of 10 Watts and H₂S / SF₆ feed ratio was within 1.7 and 2.9. Result showed that H₂S/SF₆/Ar plasma system reduced the formation of by-products such as SiF₄, SO₂ and sulfur oxyfluorides [257].

RF plasma system is effectively used for the disintegration of SF₆-R134a (isobutene-freon) effluents from resistive plate chambers detectors [258]. R134a (isobutene-freon) is used as radiation detectors which is more harmful than CO₂. The reaction chamber is filled with a gas mixture and operated at 1 Torr absolute pressure. Removal efficiency of the effluent gas mixture was more than 90% and the resultant products were mainly SiF₄ and SO₂F₂. The results revealed that the optimized electrode geometry and electrode surface temperature play a vital role in the SF₆ removal efficiency.

Kabouzi et al. studied the properties of microwave plasma and their influence on the degradation removal efficiency (DRE) of S SF₆ [259]. The plasma generator was operated at 2450 MHz with different power range (1.5 to 6 kW). The experiments were conducted at atmospheric pressure using N₂ as the plasma forming gas. In addition to that O₂ was used as an additive gas to ensure complete oxidation of SF₆. The results revealed that the degradation removal efficiency increased with the microwave power and decreased with higher gas flow rates and discharge tube radius.

Radoiu et al. studied the removal of SF₆ by microwave plasma discharge at atmospheric pressure [249]. Their studies confirmed that the addition of water vapor becomes a powerful source of free radicals formation, thus reacting with SF₆ and enhancing the removal rate. Similarly, Ahmadi et al. found that using compressed air as an additive gas was more effective than oxygen for SF₆ decomposition due to the fact that H₂O molecules in the air were efficient sources of O, H, and OH radicals [263].

In order to increase the efficiency of the SF₆ decomposition, Kim et al. designed a reverse vortex microwave plasma reactor [261]. For SF₆ abatement, they used air as an additive gas in microwave plasma reactor along with N₂/SF₆ gas mixture. The destruction and removal efficiency of the reverse vortex reactor increased by about 29% SF₆ decomposition compared to normal vortex reactor. Fig.16. shows the comparison of degradation removal efficiency (DRE) between conventional vortex and reverse vortex reactor at different applied energy densities.

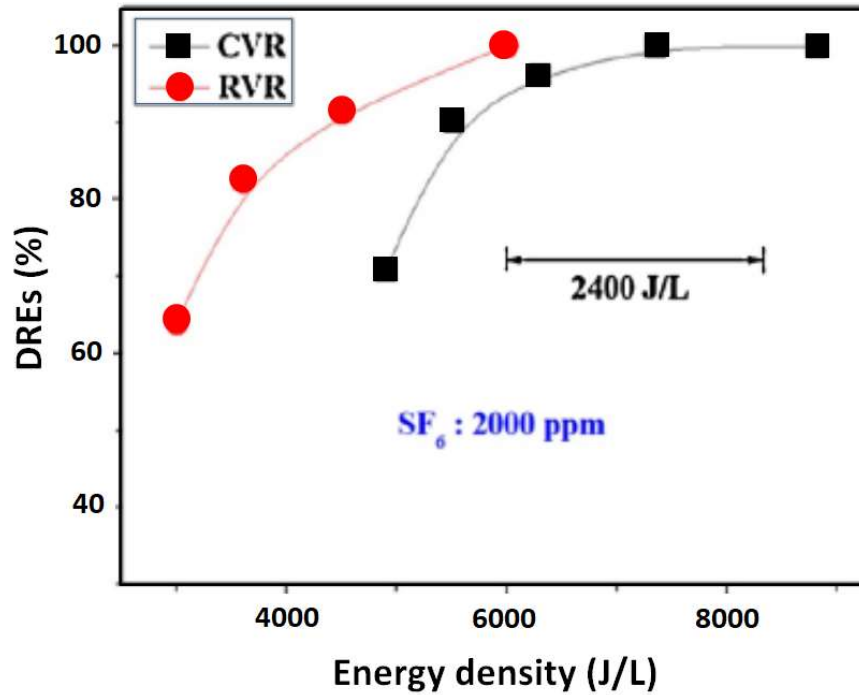

Fig.16. DREs vs applied energy density for conventional vortex reactor and reverse vortex reactor [264].

Nagai et al. studied the characteristics of SF₆ decomposition in a single layer DBD reactor with two different types of power sources (9 kHz power with a rise-time of 20 μs, and a pulsed power with a rise-time of 100 ns at a frequency of 200 pulse per minute) [262]. The studies showed that the energy efficiency of SF₆ disintegration by the pulsed power supply was greater than the regular power supply. In order to improve the SF₆ decomposition efficiency, Zhuang et al. designed a new DBD reactor with 16 star-shaped discharge elements. Obtained results showed that decomposition efficiency increased on increasing the discharge frequency and decreased with an increase in gas flow rate and SF₆ concentration [263]. Zhang et al. used double layer DBD reactor to decompose the SF₆ in the presence of water vapor with different gases (He, Ar, N₂, and air) and they found that higher removal rate and higher energy efficiency were accomplished while using Ar as the background gas. Generally, decomposition of SF₆ by DBD reactor produces SO₂, SOF₂, SO₂F₂, SOF₄ and SF₆ which cannot be released into the environment directly [264,265]. A consolidation of DBD plasma with ultraviolet photochemical collection toward appropriate material reduces the oxidized SF₆ gases. The photochemical reactions can reduce oxyfluorides [266]. Numerous attempts have been made to degrade SF₆ by plasma assisted catalytic methods. Cui et al.

investigated the degradation of SF₆ (10% SF₆ in Ar gas mixture) in DBD plasma reactor with and without catalyst (Glass beads/ γ -Al₂O₃ pellets) [267]. A high frequency AC power supply was used to generate plasma in different power ranges (0-150 Watts). It was observed that the packing materials (glass, beads and γ -Al₂O₃) significantly alter the physical characteristics of the discharge and thereby enrich the active radical's density and mean electron energy. Hence, the degradation efficiency of SF₆ was relatively higher with the presence of catalyst in the plasma zone. Particularly, γ -Al₂O₃ packed reaction gives degradation removal efficiency of 85.97% at 110 W discharge power.

Sung et al. decomposed SF₆ using thermal plasma at atmospheric pressure. 5 kW power range DC plasma torch was used for this experiment [268]. Ar gas was used as the plasma generating gas and H₂ and O₂ were used as the additive gases. The decomposition of SF₆ was analyzed by using gas chromatography. They observed that decomposition efficiency was closely related to the residence time because the decomposition efficiency of SF₆ decreased as the Ar and SF₆ flow rates were increased. The presence of additive gas increased the decomposition efficiency in thermal plasma as well. The result shows that addition of H₂ was better than O₂ as an additive gas. A SF₆ decomposition rate of 99.2% was achieved at 5 kW by using H₂ as the additive gas.

7. Summary and outlook

Extensive research on the application of plasma technology for greenhouse gas destruction and utilization is being carried out by various research teams throughout the globe. Different types of plasma sources have been successfully used for the decomposition of the greenhouse gases, which includes both the thermal and non-thermal plasmas. Although thermal plasma is an effective medium for decomposing or reforming the greenhouse gases, most of the plasma assisted decomposition of greenhouse gases have been carried out using non-thermal plasma sources. Plasma assisted catalyst reforming has been explored as a promising route for decomposition and reforming of greenhouse gases. Non-thermal plasma-based dry reforming processes have been widely investigated, but they have not yet been implemented on a commercial scale due to its low energy efficiency, yield and unresolved environmental risks. Interestingly, few of the non-thermal plasma processes such as gliding arc and microwave plasma have shown significant conversion rate and good selectivity with notable energy efficiency. However, it has not been proved whether these processes can be applied at an industrial level for large scale production of syngas. So far in non-thermal plasma route, the maximum energy efficiency is 68% and energy cost for syngas production is 10.25 kJ/L [269], which could be improved further.

Compared to non-thermal plasma very few works have been carried out using thermal plasma assisted greenhouse conversion. CO₂ reforming of CH₄ through the thermal plasma route will be a potential approach for scalable and renewable fuel production. Thermal plasma has its own advantages such as high temperature, chemically active species, large treatment capacity, fewer by-products and high energy conversion. But there are some issues that need to be addressed before they can be commercially exploited for greenhouse gas mitigation and utilization. The

existing plasma sources need further improvement for increased thermal efficiency and conversion efficiency so that the overall production cost is reduced and the technology becomes commercially feasible. It is also imperative to develop novel and as well as energy efficient thermal plasma reactors to decrease the energy consumption and to increase the treatment capacity of the reforming process. An in depth understanding of the process of converting greenhouses gases using thermal plasma operated at low power levels helps to identify the issues required to be resolved for scaling up to higher power levels and industrial applications. Meantime, recent developments in material science can lead to development of more efficient catalytic materials, which can be coupled with the plasma sources to improve the conversion efficiency and to make the plasma-catalytic hybrid process a commercial success. These are excellent opportunities for researchers in the field of plasma applications for greenhouse gas mitigation and utilization. Besides mitigating the greenhouse gas emission, the technology offers an eco-friendly alternate route for cleaner fuels and energy sources.

Acknowledgements

Authors would like to express their sincere gratitude to Department of Science and Technology (DST), India for providing the financial support under the MI-Carbon Capture Innovation Challenge (IC#3) programme (Grant No.: DST/TM/EWO/MI/CCUS/06) to conduct this research work. Further, the author Y.S gratefully acknowledge the financial support received from the DST-SERB under Grant No CRG/2018/002001.

References

1. Saha D, Grappe HA, Chakraborty A, Orkoulas G. Postextraction separation, on-board storage, and catalytic conversion of methane in natural gas: A review. *Chem. Rev.* 2016;116:11436–99.
2. U.K. Met Office. *Warming: A guide to climate change.* Exeter, U.K.: Met Office Hadley Centre; 2011.

3. Shah JJ, Singh HB. Distribution of volatile organic chemicals in outdoor and indoor air. *Environ Sci Technol.*1988;22:1381–88.
4. Pachauri RK, Meyer LA. Synthesis Report. Contribution of working groups I, II and III to the fifth assessment report of the intergovernmental panel on climate change, Geneva. IPCC 2014: Climate Change 2014:
5. BP. Statistical review of world energy. 2019
6. Intergovernmental panel on climate change third assessment report 2011.
7. Sustainable chemistry strategic research agenda; European technology platform for sustainable chemistry: Belgium, Brussels, 2005; <http://www.suschem.org/cust/documentrequest.aspx?DocID=105>.
8. Fourth assessment report: Climate change 2007 synthesis report; Intergovernmental Panel on Climate Change IPCC: Switzerland, Geneva, 2007; http://www.ipcc.ch/publications_and_data/ar4/syr/en/contents.html.
9. Frosch RA. The industrial ecology of the 21st century. *Sci Am*1995; 283:180–83.
10. Johnson L, Grant J, Low PL. Two degrees of separation: ambition and reality: Low Carbon Economy Index 2014, 2014.
11. Albo J, Alvarez-Guerra M, Castan˜o P, Irabien A. Towards the electrochemical conversion of carbon dioxide into methanol. *Green Chem.*, 2015;17:2304–24.
12. Fiorani G, Guo W, Kleij Aw, Sustainable conversion of carbon dioxide: the advent of organocatalysis *Green Chem.*, 2015;17:1375–89.
13. Kargbo DM, Wilhelm RG, Campbell DJ. Natural gas plays in the marcellus shale: challenges and potential opportunities. *Environ. Sci. Technol.* 2010;44: 5679-84
14. Mauthe, G, Niemeyer, L, Pryor, B.M., Probst R. SF6 and the global atmosphere. *Electra* 1996;164:121–31.
15. Rayne S, Thermal carbon dioxide splitting: A summary of the peer-reviewed scientific literature. *Nat. Preced.*, 2008;198: 1–17.
16. Huang L, Dong W, Zhang R, Hou H. Investigation of a new approach to decompose two potent greenhouse gases: photoreduction of SF6 and SF5CF3 in the presence of acetone. *Chemosphere* 2007; 66:833–40.
17. Huang L, GU, Yang, Dinghong, Longyu, Xia, Lanyan, Zhang, Renxi, Hou, Huiqi. Photoreductive degradation of sulfur hexafluoride in the presence of styrene. *Journal of Environmental Sciences* 2008;20:183-88.
18. Yu B, He LN. Upgrading carbon dioxide by incorporation into heterocycles. *Chem Sus Chem.* 2015;8:52–62.
19. Guo X, Fang G, Li G, Ma H, Fan H, Yu L, Ma C, Wu X, Deng D, Wei M, Tan D, Si R, Zhang S, Li J, Sun L, Tang Z, Pan X, Bao X, Direct, nonoxidative conversion of methane to ethylene, aromatics, and hydrogen. *Science* 2014;344: 616–19.
20. Choudhary TV, Aksoylu E, Goodman DW. Nonoxidative activation of methane. *Catal Rev* 2003;45:151–203.
21. Nikoo MK, Amin NAS. Thermodynamic analysis of carbon dioxide reforming of methane in view of solid carbon formation. *Fuel processing technology* 2011;92: 78-91.

22. Pawelec B, Damyanova S, Arishtirova K, Fierro JLG, Petrov L. Structural and surface features of PtNi catalysts for reforming of methane with CO₂. *Applied Catalysis A: General* 2007;323:188-201.
23. Long W, Brunelli NA, Didas SA, Ping EW, Jones CW. Aminopolymer-silica composite-supported Pd catalysts for selective hydrogenation of alkynes. *ACS Catal* 2013;3:1700-08.
24. Ewbank, JL, Kovarik L, Diallo, FZ, Sievers C. Effect of metal-support interactions in Ni/Al₂O₃ catalysts with low metal loading for methane dry reforming. *Applied Catalysis A: General* 2015; 494: 57-67
25. Bouarab R, Akdim, O, Auroux, A, Cherifi, O, Mirodatos C. Effect of MgO additive on catalytic properties of Co/SiO₂ in the dry reforming of methane. *Appl. Catal. A Gen.* 2004;264:161-68.
26. Wang S, Lu GQ, Millar GJ. Carbon dioxide reforming of methane to produce synthesis gas over metal-supported catalysts: state of the art. *Energy Fuels* 1996;10:896-904.
27. Wang YF, Tsai CH, Chang WY, Kuo YM. Methane steam reforming for producing hydrogen in an atmospheric-pressure microwave plasma reactor. *Int J. Hydrogen Energy* 2010;35:135-40.
28. Chen HL, Lee HM, Chen SH, Chao Y, Chang MB. Review of plasma catalysis on hydrocarbon reforming for hydrogen production—interaction, integration, and prospects. *Appl. Catal., B* 2008;85:1-9.
29. Holmen A, Direct conversion of methane to fuels and chemicals. *Catal. Today*, 2009;142,:2-8.
30. Alvarez-Galvan MC, Mota N, Ojeda M, Rojas S, Navarro RM, Fierro JLG, Direct methane conversion routes to chemicals and fuels. *Catal. Today* 2011;171:15-23.
31. Schwarz H. *Angew. Chemistry with Methane: Concepts rather than recipes*. *Chem., Int. Ed.*, 2011;50:10096-115.
32. Dasireddy VDBC, Likozar B, Activation and decomposition of methane over cobalt-, copper-, and iron-based heterogeneous catalysts for CO_x-free hydrogen and multiwalled carbon nanotube production. *Energy Technol.* 2017;5:1344-55.
33. Puliyalil H, Cvelbar U. Selective plasma etching of polymeric substrates for advanced applications. *Nanomaterials* 2016;6: 108
34. Filipic G, Baranov O, Mozetic M, Cvelbar U. Growth dynamics of copper oxide nanowires in plasma at low pressures, *Journal of Applied Physics* 2015;117: 043304
35. Tao X, Qi F, Yin Y, Dai X. CO₂ reforming of CH₄ by combination of thermal plasma and catalyst, *International J. Hydrogen energy* 2008;33:1262-65.
36. Ma X, Li S, Maria RL, Choudhary R, Lin L, Rooji G, Galluci F, Rothenberg G, Shiju NR, Hessel V. Plasma assisted catalytic conversion of CO₂ and H₂O over Ni/Al₂O₃ in a DBD reactor. *Plasma Chemistry and Plasma Processing* 2019; 39:109-24.

37. Chen G, Georgieva V, Godfroid T, Snyders R, Ogletree MPD. Plasma assisted catalytic decomposition of CO₂. *Applied Catalysis B: Environmental* 2016; 190: 115–24.
38. Pfender E, Boulos M, and Fauchais P. Methods and principles of plasma generation. *Plasma technology in Metallurgical processing*, Fineman J. (ed), , Iron and Steel Society, 1987;Chap.4:27.
39. Chitra Natarajan , *Plasma technology - potential industrial applications*, 3rd SERC School on Plasma Surface Interaction and Plasma Processing, Pune. 1993.
40. Mucha JA, Hess DW, Aydil ES, Plasma etching, in: L.F. Thompson, C.G. Willson, M.J. Bowden (Eds.), *Introduction to microlithography*, American Chemical Society, Washington, D.C., 1994, pp. 377–507
41. Chen FF., *Introduction to plasma physics and controlled fusion*, Plenum press Newyork and London 1984.
42. Oumghar, JC. Legrand, AM. Diamy, Turillon N. Methane conversion by an air microwave plasma. *Plasma Chem. Plasma Process.*1995;15: 87-107.
43. Eliasson, Liu CJ, Kogelschatz U. Direct conversion of methane and carbon dioxide to higher hydrocarbons using catalytic dielectric-barrier discharges with zeolites”,*Ind. Eng. Chem. Res.*2000;39:1221-27.
44. Yao SL, Nakayama A, Suzuki E. Methane conversion using a high-frequency pulsed plasma: Important factors. *AIChE J.*2001; 47: 413-418.
45. Deng XQ, Liu JL, Li XS, Zhu B, Zhu X, Zhu AM. Kinetic study on visible-light photocatalytic removal of formaldehyde from air over plasmonic Au/TiO₂. *Catal. Today*, 2017;281:630–35.
46. Gruenwald J, Reynvaan JJ, Eisenberg T, Geistlinger P. Characterisation of a Simple Non-Thermal Atmospheric Pressure Plasma Source for Biomedical Research Applications.*Contrib. Plasma Phys.*, 2015;55: 337–46.
47. Bazaka K, Jacob MV, Crawford RJ, Ivanova EP. Plasma-assisted surface modification of organic biopolymers to prevent bacterial attachment. *Acta Biomater* 2011;7:2015–28.
48. Filipi~c G, Cvelbar U, Copper oxide nanowires: a review of growth *Nanotechnology* 2012;23:194001.
49. Bazaka K, Jacob MV, Chrzanowski W, Ostrikov K, Anti-bacterial surfaces: natural agents, mechanisms of action, and plasma surface modification. *RSC Adv.*, 2015;5: 48739–59.
50. Vasilev K, Griesser SS, Griesser HJ, Antibacterial surfaces and coatings produced by plasma techniques. *Plasma Processes Polym* 2011;8:1010–23.
51. Heberlein J. New approaches in thermal plasma technology, *Pure Appl. Chem.*,2002;74(3):327–35.

52. Rao NP, Tymiak N, Blum J, Neuman A, Lee HJ, Girshick SL, McMurry PH, Heberlein J. Hypersonic plasma particle deposition of nanostructured silicon and silicon carbide. *J. Aerosol Sci.* 1998;29:707–20.
53. Kong PC, Pfender E. Formation of ultrafine β -Silicon carbide powders in an argon thermal plasma Jet. *Langmuir* 1987;3:259–65.
54. Tendler M, Rutberg P, Oost G. Plasma based waste treatment and energy production, *Plasma Phys. Control. Fusion* 2005;47:A219–30.
55. Heberlein J. Thermal plasmas for the destruction of hazardous wastes *Proc. Plasma Technologies for Hazardous Waste Destruction*, (Como, Italy) ed G Bonizzoni et al. (Bologna, Italy: Editrice Compositori) 1992:59–76
56. Solonenko OP, Gulyaev IP, Smirnov AV. Thermal plasma processes for production of hollow spherical powders: theory and experiment, *J. Therm. Sci. Technol.* 2011;6:219–34.
57. Feinman J. *Plasma Technology in Metallurgical Processing*, Iron and Steel Soc. of AIME 1987: 500-08.
58. Ton H. Physical properties of the plasma-MIG welding arc, *J. Phy. D: Appl. Phys.* 1975; 8:922.
59. Zhang ZL, Bell T. Structure and corrosion resistance of plasma nitride stainless steel, *Surface Engineering* 1984; 1:131-36.
60. Liang W. Surface modification of AISI 304 austenitic stainless steel by plasma nitriding. *Applied Surface Science* 2003;211:308–14.
61. Cao XQ, Vassen R, Stoeverb D. Ceramic materials for thermal barrier coatings, *Journal of the European Ceramic Society* 2004;24:1–10.
62. Cernuschi F, Bianchi P, Leoni M, Scardi P. Thermal diffusivity/microstructure relationship in Y-PSZ thermal barrier coatings, *Journal of thermal spray technology* 1999;8:102-09.
63. Fridman A, Nester S, Kennedy LA, Saveliev A, Yardimci OM . Gliding arc gas discharge. *Prog Energy Combust Sci* 1999;25:211.
64. Eliasson B Kogelschatz U, Modeling and applications of silent discharge plasmas. *IEEE Trans. Plasma Sci.* 1991;19:309 .
65. Salge J. Plasma-assisted deposition at atmospheric pressure . *J. de Physique IV* 1995;5:583-92.
66. Hocker H. Plasma treatment of textile fibers. *Pure Appl Chem.* 2002;74(3):423–7.
67. Gilman AB. Interaction of chemically active plasma with surfaces of synthetic materials. In: Fortov VE, editor. *Encyclopedia of low-temperature plasma.* Moscow: Pleiades Publishing 2000;4: 393.
68. Kogelschatz U. Dielectric-barrier discharges principle and applications. *Plasma Chem. Plasma Process* 2003; 23(1):1–46
69. Vezzo G, Lopez JL, Freilich A, Becker KH. Optimization of large-scale ozone generators. *IEEE Trans Plasma Sci* 2009;37:890-96.
70. Gallagher MJ, Vaze N, Gangoli S, Vasilets VN, Gutsol AF, Milovanova TN, Anandan S, Murasko DM, and Fridman AA. Rapid inactivation of airborne bacteria

- using atmospheric pressure dielectric barrier grating discharge. *IEEE transactions on plasma science* 2007;35:1501-10
71. Roth JR. *Industrial plasma engineering: vol. 1—Principles*. IOP, Bristol and Philadelphia, 1995.
 72. Thyen R, Weber A, Klages CP, Plasma-enhanced chemical-vapour-deposition of thin films by corona discharge at atmospheric pressure. *Surf. Coat. Technol.* 1997; 97:426.
 73. Junhong C, Davidson JH. Ozone production in the negative DC corona: The dependence of discharge polarity. *Plasma Chem. Plasma Process* 2003; 23: 501-18.
 74. Abou-Ghazala A, Schoenbach K H, Dobbs F C and Moreira K R 2001 *IEEE Int. Conf. Plasma Science, LasVegas NV 2*
 75. Hartmann W, Romheld M, Rohde KD. All-solid-state power modulator for pulsed corona plasma reactors. *IEEE Trans. Dielectr. Electr. Insul.*2007;14: 858
 76. Blackman BRK, Kinloch AJ, Watts JF. The plasma treatment of thermoplastic fibre composites for adhesive bonding. *Composites* 1994;25:332-41.
 77. Martinez-Garcia A, Sanchez-Reche A, Gisbert-Soler S, Cepeda-Jimenez C M, Torregrosa-Macia R and Martin-Martinez J M. Treatment of EVA with corona discharge to improve its adhesion to polychloroprene adhesive. *J. Adhes. Sci. Technol.* 2003;17:47.
 78. Takahashi N, Goldman A, Goldman M, Rault J. Surface modification of LDPE by a DC corona discharge generated in a point-to-grid system: the influence of geometric parameters of the system on modification power. *J. Electrostat.*2000; 50: 49-63.
 79. Fridman A, Nester S, Kennedy LA, Saveliev A, Mutaf-Yardimci O. Gliding arc gas discharge. *Prog Energy Combust Sci* 1999;25:211-31.
 80. Yu L, Li X, Tu X, Wang Y , Lu S, Yan J. Decomposition of Naphthalene by dc Gliding Arc Gas Discharge. *J. Phys. Chem.* 2010;114:360–8.
 81. Czernichowski A. Gliding arc. Applications to engineering and environment control *Pure Appl Chem* 1994;66(6):1301-10.
 82. Moussa, D. Vitrac H, Chéron, BG, Hnatiuc E, Addou A, Brisset, JL, Acidity control of the oxidation reactions induced by non-thermal plasma treatment of aqueous effluents in pollutant abatement processes. *European Physical Journal of Applied Physics*, 2005; 29:189-93.
 83. Ahmar EE, Met C, Aubry O, Khacef A, Cormier JM., Hydrogen enrichment of a methane-air mixture by atmospheric pressure plasma for vehicle applications, *Chem. Eng. J.* 2006;116:13-18.
 84. Thammanoon S, Yoshikawa S. Enhanced photocatalytic hydrogen evolution over Pt supported on mesoporous TiO₂ prepared by single-step sol–gel process with surfactant template. *International Journal of Hydrogen Energy* 2006;31:786-96.
 85. Alves P, Pinto S, de Sousa HC, Gil MH. Surface modification of a thermoplastic polyurethane by low-pressure plasma treatment to improve hydrophilicity. *J. Appl. Polym. Sci.* 2011;122:2302-08.
 86. Kusano Y, Norrman K, Drews J, Leipold F, Singh SV, Morgen P, Bardenshtein A, Kerbs N. Gliding arc surface treatment of glass-fiber-reinforced polyester enhanced by ultrasonic irradiation. *Surface and coating technology* 2011;205:S490-94.

87. Shiki H, Motoki J, Ito Y, Takikawa H, Ootsuka T, Okawa T, Yamanka S, Usuki E, Nishimura Y, Hishida S, Sakakibara T. Development of split gliding arc for surface treatment of conductive material. *Thin solid films* 2008;516:3684-89.
88. Andrei VN, Ionut T, Constantin G, Valentin P, Gheorghe P. Stimulation of wound healing by helium atmospheric pressure plasma treatment. *J. Phys. D: Appl. Phys* 2011; 44: 105204
89. Fridman A, Chirokov A, Gutsol, A. Non-thermal atmospheric pressure discharges. *Journal of Physics D-Applied Physics* 2005; 38: R1–R24.
90. Dobrynin D, Fridman G, Friedman G. Physical and biological mechanisms of direct plasma interaction with living tissue. *New J. Phys.*2009;11:115020.
91. Hong YC, Cho SC, Bang CU, Shin DH, Kim JH, Uhm HS, Yi WJ. Microwave plasma burner and temperature measurements in its flames. *Appl. Phys. Lett* 2006; 88: 201502.
92. Kim HH, Tsubota S, Dat'e M, Ogata A, Futamura S. Catalyst regeneration and activity enhancement of Au/TiO₂ by atmospheric pressure nonthermal plasma. *Appl. Catal., A*, 2007; 329:93–98.
93. US Environmental Protection Agency 2002;
94. Faramawy S, Zaki T, E-Sakr AA. Natural gas origin, composition, and processing: A review. *Journal of Natural Gas Science and Engineering* 2016;34:34-54.
95. Aerts R, Somers W, Bogaerts A. Carbon dioxide splitting in a dielectric barrier discharge plasma: A combined experimental and computational study *Chem.Sus Chem*, 2015; 8:702–16
96. Paulussen S, Verheyde B, Tu X, Bie CD, Martens T, Petrovic D, Bogaerts A, Sels B. Conversion of carbon dioxide to value-added chemicals in atmospheric pressure dielectric barrier discharges. *Plasma Sources Sci. Technol.* 2010;19: 34015.
97. Wen Y, Jiang X Decomposition of CO₂ using pulsed corona discharges combined with catalyst. *Plasma Chem Plasma Process* 2001; 21(4):665–78.
98. Maezono I, Chang JS. Reduction of CO₂ from combustion gases by DC corona torches. *IEEE Trans. Ind. Appl* 1990; 26(4):651–55.
99. Wang JY, Xia GG, Huang A, Suib SL, Hayashi Y, Matsumoto H. CO₂ decomposition using glow discharge plasmas. *J Catal* 1999; 185:152–59.
100. Buser RG, Sullovan JJ. Initial process in CO₂ glow discharges. *J Appl. Phys.* 1970; 41(2):472–79.
101. Savinov SY, Lee H, Song HK, Na B-K. Decomposition of methane and carbon dioxide in a radio-frequency discharge. *Ind. Eng. Chem. Res* 1999; 38:2540–47.
102. Nunnally T, Gutsol A, Rabinovich A, Fridman A, Gutsol A, Kemoun A. Dissociation of CO₂ in a low current gliding arc plasmatron. *J. Phys. D: Appl. Phys.*2011;44: 274009
103. Kobayashi A, Osaki K, Yamabe C. Treatment of CO₂ gas by high-energy type plasma. *Vacuum* 2002;65:475–79.
104. Yu Q, Kong M, Liu T, Fei J, Zheng X. Characteristics of the Decomposition of CO₂ in a dielectric packed-bed plasma reactor. *Plasma Chem. Plasma Process.*, 2012;32:153-163.

105. Ozkan A, Bogaerts A, Reniers , Routes to increase the conversion and the energy efficiency in the splitting of CO₂ by a dielectric barrier discharge. *J. Phys. D: Appl. Phys.*, 2017; 50: 84004.
106. Li R, Tang Q, Yin S, Sato T. Plasma catalysis for CO₂ decomposition by using different dielectric materials. *Fuel Processing Technology* 2006; 87: 617-22.
107. Tagawa Y, Mori S, Suzuki M, Yamanaka I, Obara T, Ryu J and Kato Y. Synergistic decomposition of CO₂ by hybridization of a dielectric barrier discharge reactor and a solid oxide electrolyser cell. *Kagaku Kogaku Ronbunshu*. 2011;37:114–19.
108. Belov I, Paulussen S, Bogaerts A. Appearance of a conductive carbonaceous coating in a CO₂ dielectric barrier discharge and its influence on the electrical properties and the conversion efficiency. *Plasma Sources Sci. Technol.*, 2016;25;15023.
109. Rusanov VD, Fridman A, Sholin GV. The physics of a chemically active plasma with nonequilibrium vibrational excitation of molecules. *American Institute of Physics* 1981;24(6):1447–1474.
110. Kozák, T, Bogaerts, A. Evaluation of the energy efficiency of CO₂ conversion in microwave discharges using a reaction kinetics model. *Plasma Sources Sci. Technol.* 2015; 24:015024
111. Spencer LF Gallimore AD. CO₂ dissociation in an atmospheric pressure plasma/catalyst system: a study of efficiency. *Plasma Sources Sci. Technol.*2013;22:15019.
112. Goede, APH, Bongers WA, Graswinckel MG, van de SandenRMCM, Leins M, Kopecki J, Schulz A, Walker M. Production of solar fuels by CO₂ plasmolysis. *EPJ Web Conf.* 2014; 79: 01005.
113. Silva T, Britun N, Godfroid T, Synders R. Optical characterization of a microwave pulsed discharge used for dissociation of CO₂. *Plasma Sources Sci. Technol.*2014; 23: 025009.
114. Vesel A, Mozetic M, Drenik A, Marianne BP. Dissociation of CO₂ molecules in a microwave plasma. *Chemical Physics* 2011;382:127-31.
115. Heijkers S, Snoeckx R, Koza'k T, Silva T, Godfroid T, Britun N, Snyders R, Bogaerts A. CO₂ conversion in a microwave plasma reactor in the presence of N₂: elucidating the role of vibrational levels. *J. Phys. Chem. C*. 2015;119:12815–28.
116. Lunsford JH. Catalytic Conversion of methane to more useful chemicals and fuel: The challenge for the 21st century. *Catalysis Today*. 2000; 63:165-74.
117. Fox JM, III, The different catalytic routes for methane valorization: An assessment of process for liquid fuels. *Catal. Rev. Sci. Eng* 1993;35: 169-212.
118. Parkyns ND, Warburton CI, Wilson D. Natural gas conversion to liquid fuels and chemicals: Where does it stand?. *Catalysis Today*. 1993;18:385-442.
119. Oh YS, Roh HS, JunKW, Baek YS. A highly active catalyst, Ni/Ce–ZrO₂/θ-Al₂O₃, for on-site H₂ generation by steam methane reforming: pretreatment effect. *Int. J Hydrogen Energy* 2003; 28:1387–92.

120. Levent M, Gunn DJ, El-Bousi MA. Production of hydrogen-rich gases from steam reforming of methane in an automatic catalytic micro reactor. *Int. J. Hydrogen Energy* 2003;28:945–59.
121. Choudhary VR, Mondal KC. CO₂ reforming of methane combined with steam reforming of partial oxidation of methane to syngas over NdCoO₃ perovskite- type mixed metal-oxide catalyst. *Appl. Energy* 2006;83:1024–32.
122. Wu P, Li X, Ji S, Lang B, Habimana F, Li C. Steam reforming of methane to hydrogen over Ni-based metal monolith catalysts *Catal Today* 2009;146:82– 86.
123. Angeli SD, Monteleone G, Giaconia A, Lemonidou AA. State-of-the-art catalysts for CH₄ steam reforming at low temperature . *Int. J. Hydrogen Energy* 2014;39:1979–97.
124. Bičáková O, Straka P. Production of hydrogen from renewable resources and its effectiveness. *Int. J. Hydrogen Energy* 2012;37:11563–78.
125. Enger BC, Lodeng R, Holme A, A Review of catalytic partial oxidation of methane to synthesis gas with emphasis on reaction mechanisms over transition metal, catalysts,. *Appl Catal A Gen* 2008: 346:1-27.
126. Jo S, Lee DH, Song YH. Effect of gas temperature on partial oxidation of methane in plasma reforming. *Int. J. Hydrogen Energy* 2013;346:1-27.
127. Ozdemir H, OKsuzomer MAF, GURkyank MA. Effect of calcination temperature on Ni/MgAl₂O₄ Catalytic structure and catalytic properties of partial oxidation of methane. *Fuel* 2014; 116: 63-70.
128. Simeone M, Salemme L, Menna L, Methane autothermal reforming in a reverse flow reactor on Rh/Al₂O₃ Catalyst. *Int. J. Hydrogen Energy* 2012; 37: 9049-57.
129. Ismagilov Z , Matus EV, Kuznetsov VV, Mota N, Navarro RM, Kerzhentsev MA, Ismagilov ZR, Fierro JLG, Nanoscale control during synthesis of Me/ La₂O₃, Me/Ce_xGd_{1-x}O_y and MeCe_xZr_{1-x}O_y (Me =Ni,Pt, Pd,Rh) catalyst for auto thermal reforming of methane .*Catal Today* 2013; 210:10-8.
130. Palma V, Ricca A, Ciambelli P. Structured catalysss for methane auto thermal reforming in a compact thermal integrated reaction system. *Appl Therm Eng* 2013; 61:128-33.
131. Ruckenstein E, Hu YH. Carbon dioxide reforming of methane over nickel/ alkaline earth metal oxide catalysts. *Appl Catal A Gen* 1996; 133:149-61.
132. Kraus M , Eliasson B, Kogelschatz U, Wokaun A. CO₂ reforming of methane by the combination of dielectric barrier discharges and catalysis, *Phys, Chem Chem Phys* 2001; 3: 294-300.
133. Wang JX, Liu Y, Cheng TX, Li WX, Bi YL, Zhen KJ. Methane reforming with carbon dioxide to synthesis gas over Co- doped Ni based magnetoplumbite catalysts. *Appl Catal A Gen* 2003;250:13-23.

134. Cheng DG, Xia Q, Liu CJ. Plasma enhanced preparation of highly dispersed Ni/Al₂O₃ catalyst for CO₂ reforming of methane. *Stud Surf Sci Catal* 2004;153:33-40.
135. Ghorbanzadeh AM, Modaressi H. Carbon dioxide reforming of methane by pulsed glowdischarge at atmospheric pressure: the effect of pulse compression. *J Appl Phys* 2007; 101:123303-1-10.
136. Cheng YG, Tomishige K, Yokoyama K, Fujimoto K. Promoting effect of Pt, Pd and Rh noble metals to the Ni_{0.03} Mg_{0.970} solid solution catalysts for the reforming of CH₄ with CO₂. *Appl Catal A Gen* 1997; 165:335-47.
137. Wang HY, Ruckenstein E. Carbon dioxide reforming of methane to synthesis gas over supported rhodium catalysts: the effect of support. *Appl Catal A Gen* 2000; 204:143-52.
138. Portugal UL, Marques CMP, Araujo ECC, Morales EV, Giotto MV, BuenJMC. CO₂ reforming of methane over zeolite Y supported ruthenium catalysts. *Appl Catal A Gen* 2000; 193:173-83.
139. Basile F, Fornasari G, Trifiro F, Vaccari A. Rh-Ni synergy in the catalytic partial oxidation of methane: surface phenomena and catalyst stability. *Catal. Today* 2002; 77:215-23.
140. Gheno SM, Damyanova S, Riguetto BA, Marques CMP, Leite CAP, Bueno JMC. CO₂ reforming of CH₄ over Ru/zeolite catalysts modified with Ti. *J Mol Catal A Chem* 2003; 198:263-75.
141. Rivas MF, Fierro JLG, Goldwasser MR, Pietri E, Perez-Zurita MJ, Griboval-constant A, Leclercq G. Structural features and performance of LaNi_{1-x}Rh_xO₃ system for the dry reforming of methane. *Appl Catal A Gen* 2008; 344:10-9.
142. Safariamin M, Tidahy LH, Abi-Aad E, Siffert S, Aboukais. Dry reforming of methane in the presence of ruthenium-based catalysts. *Comptes Rendus Chim* 2009;12:748-53.
143. Tu X, Whitehead JC. Plasma-catalytic dry reforming of methane in an atmospheric dielectric barrier discharge: Understanding the synergistic effect at low temperature. *Applied Catalysis B: Environmental* 2012; 125: 439-448.
144. Bradford MCJ, Vannice MA. CO₂ Reforming of CH₄. *Catalysis Reviews* 1999;41:1-42.
145. Wang S, Lu GQ, Millar GJ. Carbon dioxide reforming of methane to produce synthesis gas over metal-supported catalysts: state of the art. *Energy Fuels* 1996; 10:896-904.
146. Juan-Juan J, Roman-Martinez MC, Jilán-Gómez M. Catalytic activity and characterization of Ni/Al₂O₃ and NiK/Al₂O₃ catalysts for CO₂ methane reforming. *Applied Catalysis A: General* 2004;264:169-174.

147. Guo J, Lou H, Zhao H, Chai D, Zheng X. Dry reforming of methane over nickel catalysts supported on magnesium aluminate spinels. *Applied Catalysis A: General* 2004;273: 75–82.
148. Pompeo F, Nichio NN, Gonzalez MG, Montes M. Characterization of Ni/SiO₂ and Ni/Li-SiO₂ catalysts for methane dry reforming. *Catalysis Today* 2005; 107–108: 856–862.
149. Tu X, Gallon HJ, Twigg MV, Gorry PA, Whitehead JC. Dry reforming of methane over a Ni/Al₂O₃ catalyst in a coaxial dielectric barrier discharge reactor, *J Phys. D* 2011; 44: 274007.
150. Bromberg L, Cohn DR, Rabinovich A. Plasma reforming of methane. *Energy Fuels* 1998;12:11-18.
151. Suib SL, Zenger RP. A Direct, Continuous, low-Power catalytic conversion of methane to higher hydrocarbons via microwave plasmas. *J. Catal.* 1993; 139: 383-91.
152. Liu C, Mallinson R, Lobban L. Comparative investigations on plasma catalytic methane conversion to higher hydrocarbons over zeolites. *Appl. Catal. A*1999; 178:17-27.
153. Kado S, Sekine Y, Fujimoto K, Direct synthesis of acetylene from methane by direct current pulse discharge. *Chem. Commun.* 1999;2485-86.
154. Larkin DW, Lobban LL Mallinson RG. The direct partial oxidation of methane to organic oxygenates using a dielectric barrier discharge reactor as a catalytic reactor analog. *Catal.Today*, 2001;71:199–210.
155. Matsumoto H, Tanabe S, Okitsu K, Hayashi Y, Suib SL. Selective oxidation of methane to methanol and formaldehyde with nitrous oxide in a dielectric-barrier discharge–plasma reactor. *J. Phys. Chem.* 2001;105:5304-08.
156. Bugaev SP, Kozyrev AV, Kuvshinov VA, Sochugov NS, Khryapov PA, Plasma-chemical conversion of lower alkanes with stimulated condensation of incomplete oxidation products. *Plasma Chem. Plasma Process.*1998;18: 247-61.
157. Okumoto M, Su Z, Katsura S, Mizuno A. Dilution effect with inert gases in direct synthesis of methanol from methane using nonthermal plasma. *IEEE Trans.Ind. Appl* 1999; 35:1205–10.
158. Sekine Y, Fujimoto K. New method for direct conversion of methane. *Kinet. and Catal.* 1999;40:294-300.
159. Hijikata K, Ogawa K, Miyakawa N. Methanol conversion from methane and water vapor by electric discharge (effect of electric discharge process on methane conversion). *Heat Trans Asia Res* 1999;28(5):404–417.
160. Yao SL, Ouyang F, Nakayama A, Suzuki E. Application of a pulse discharge in partial oxidation of methane. *Trans. Mater. Res. Soc. Jpn.* 2000;25:373-76.
161. Aerts R, Martens T, Bogaerts A. Influence of vibrational states on CO₂ splitting by dielectric barrier discharges. *J. Phys. Chem. C*, 2012;116: 23257–73.
162. Lan TS, Yi R, Hua-li L, Wang Yu-jie W, Yongxiang Y. Experimental study on syngas production by carbon dioxide reforming of methane by plasma jet. *Natural Gas Industry* 2007 ; 27: 129–32.

163. Kado S, Sekine Y, Nozaki T, Okazaki K. Diagnosis of atmospheric pressure low temperature plasma and application to high efficient methane conversion. *Catal. Today*, 2004; 89: 47–55.
164. Zhang YP, Li Y, Wang Y, Liu CJ, Eliasson B. Plasma methane conversion in the presence of carbon dioxide using dielectric-barrier discharges. *Fuel Process. Technol* 2003;83:101–109.
165. Hwang B-B, Yeo Y-K, Na B-K. Conversion of CH₄ and CO₂ to syngas and higher hydrocarbons using dielectric barrier discharge. *Korean J Chem Eng* 2003; 20(4):631–634.
166. Kim S-S, Lee H, Choi J-W, Na B-K, Song HK. Kinetics of the methane decomposition in a dielectric-barrier discharge. *J Ind Eng Chem* 2003a; 9(6):787–91
167. Kim S-S, Lee H, Na B-K, Song HK. Reaction pathways of the methane decomposition in a dielectric-barrier discharge. *Korean J Chem Eng* 2003b; 20(5):869–72.
168. Jeong HK, Kim SC, Han C, Lee H, Song HK, Na BK. Conversion of methane to higher hydrocarbons in pulsed DC barrier discharge at atmospheric pressure. *Korean J. Chem. Eng.* 2001;18:196-201.
169. Savinov SY, Lee H, Song HK, Na B-K. A kinetic study on the conversion of methane to higher hydrocarbons in a radiofrequency discharge. *Korean J Chem Eng* 2004; 21(3):1–10
170. Lee H, Savinov SY, Song HK, Na BK. Estimation of the methane conversion in a capacitively coupled radiofrequency discharge. *J Chem Eng Jpn* 2001;34:1356-65.
171. Legrand JC, Diamy AM, Hrach R, Hrachov_a V. Methane conversion in the flowing afterglow of a dinitrogen microwave plasma initiation of the reaction. *Contrib Plasma Phys* 1997;37:521-37.
172. Liu C, Marafee A, Mallinson R, Lobban L. Methane conversion to higher hydrocarbons in a corona discharge over metal oxide catalysts with OH groups. *Appl. Catal., A*, 1997;164;21–33.
173. Fabry F, Flamant G, Fulcheri L. Carbon black processing by thermal plasma analysis of the particle formation mechanism. *Chem Eng Sci* 2001; 56:2123–32.
174. Tao X, Bai M, Wu Q, Huang Z, Yin Y, Dai X. CO₂ reforming of CH₄ by binode thermal plasma. *Int J Hydrogen Energy* 2009;34:93733-78.
175. Diamy A-M, Hrach R, Hrachova V, Legrand J-C. Influence of C atom concentration for acetylene production in CH₄/N₂ after glow. *Vacuum* 2001; 61:403–07.
176. Indarto A, Choi JW, Lee H, Song HK. Methane conversion using dielectric barrier discharge: comparison with thermal process and catalyst effects. *J. Natur Gas Chem.* 2006; 15(2):87–92.
177. Zhou L, Xue B, Kogelschatz U, Eliasson B. *Plasma Chem. Plasma Process* 1998;18: 375–93.
178. Gesser HD, Hunter NR, Probawono D. The CO₂ reforming of natural gas in a silent discharge reactor. *Plasma Chem Plasma Process* 1998;18:241-5.
179. Liu C-J, Xue B, Eliasson B, He F, Li Y, Xu G-H. Methane conversion to higher hydrocarbons in the presence of carbon dioxide using dielectric-barrier discharge plasmas. *Plasma Chem Plasma Process* 2001;21:301-10.

180. Pham MH., Goujard, V., Tatibouët, JM., Batiot-Dupeyrat C., Activation of methane and carbon dioxide in a dielectric-barrier discharge- plasma reactor to produce hydrocarbons- Influence of La₂O₃/γ-Al₂O₃ catalyst. *Catal. today* 2011;171: 67-71.
181. Legrand JC, Diamy AM, Hrach R, Hrachova V .Mechanism of methane decomposition in nitrogen afterglow plasma. *Vacuum* 1999; 52:27–32.
182. Roch JR. *Industrial Plasma Engineering: Volume 1 Principles*, Univ Tennessee 1995.
183. Goujard V., Tatibouët, J.M., Batiot-Dupeyrat C. Carbon dioxide reforming of methane using a dielectric barrier discharge reactor: effect of helium dilution and kinetic model, *Plasma Chemistry and Plasma Processing* 2011;31:315-325
184. Fridman A. In: *plasma chemistry*, Cambridge university press, 2008, p. 21
185. Song HK, Lee H, Choi JW, Na B. Effect of electrical pulse forms on the CO₂ reforming of methane using atmospheric dielectric barrier discharge. *Plasma Chemistry and Plasma Processing* 2004;24:57–72.
186. Lee DH, Song YH, Kim KT, Lee JO. Comparative study of methane activation process by different plasma sources. *Plasma Chemistry and Plasma Processing* 2013;33:647-61.
187. Zhang Y-P, Li Y, Wang Y, Liu C-j, Eliasson B. Plasma methane conversion in the presence of carbon dioxide using dielectric-barrier discharges. *Catal. Today*.2003; 83:101–09
188. Chun YN, Kim SC. Production of hydrogen-rich gas from methane by thermal plasma reform. *Journal of the Air & Waste Management Association* 2007;57:1447-51.
189. Jasinski M, Dors M, Mizeraczyk J. Production of hydrogen via methane reforming using atmospheric pressure microwave plasma *J. Power Sources* 2008;181:41-45.
190. Wu A, Yan J, Zhang H, Zhang M, Du C, Li X. Study of the dry methane reforming process using a rotating gliding arc reactor. *International Journal of Hydrogen Energy* 2014; 39: 17656-70.
191. Stryczewska HD. Supply systems of non-thermal plasma reactors. construction review with examples of applications. *Appl. Sci.* 2020, 10, 3242;
192. Mutaf-Yardimci O, Saveliev AV, Fridman A, Kennedy LA. Thermal and nonthermal regimes of gliding arc discharge in air flow. *Journal of Applied Physics* 2000; 87: 1632
193. Richard F, Cormier JM, Pellerin S, Chapelle J. Physical study of a gliding arc discharge. *Journal of Applied Physics* 1996; 79:2245
194. Fridman A. *Plasma chemistry*, Cambridge University Press, New York, 2008
195. Hu S, Wang B, Lv Y, Yan W, Conversion of methane to C₂ hydrocarbons and hydrogen using a gliding arc reactor. *Plasma Sci. Technol* 2013;15: 555–61.
196. Indarto A, Choi JW, Lee H, Song HK. Conversion of CO₂ by gliding arc plasma. *Environ Eng Sci* 2006;23(6):1047–57
197. Wu A, Yan J, Zhang H. Zhang M, Du C, Li X. Study of the dry methane reforming process using a rotating gliding arc reactor. *International Journal of Hydrogen Energy* 2014;39:17656-17670.

198. Bo Z, Yan J, Li X, Chi Y, Cen K, Plasma assisted dry methane reforming using gliding arc gas discharge: Effect of feed gases proportion. *Int. J. Hydrogen Energy*, 2008;33:5545–53.
199. Li M, Xu G, Tian Y, Chen L, Fu H. Carbon dioxide reforming of methane using DC corona discharge plasma reaction. *J. Phys. Chem. A*, 2004;108:1687–93.
200. Bouchoul N, Fourre E, Duarte A, Tanchoux A, Louste C, Batiot –Dupeyrat C. Plasma-metal oxides coupling for CH₄-CO₂ transformation into syngas and/or hydrocarbons, oxygenates. *Catalysis Today* 2020;
201. Goujard V, Tatiboue JM, Batiot-Dupeyrat C. Use of a non-thermal plasma for the production of the synthesis gas. *Appl. Catal., A*, 2009;353:228–235.
202. Jiang Z, Xiao T, Kuznetsov VL, Edwards PP. Turning Carbon dioxide into fuel. *Philos. Trans. R. Soc., A*, 2010;368:3343–64.
203. Lee H, Song HK, Min BR. Heating effect of plasma catalytic reaction on the CH₄ reforming of CO₂ over Ni/γ-Al₂O₃ catalyst in dielectric-barrier discharge reactor. *Chemistry Letters*; 2006;35:646-47.
204. Lee DH, Song YH, Kim KT, Lee JO. Comparative study of methane activation process by different plasma sources. *Plasma Chem. Plasma Process* 2013;33:647-661.
205. Indarto A, Choi JW, Lee H, Song HK. CO₂ Reforming of methane via low temperature plasma. *Energy* 2006; 31:2650-59.
206. Heintze M, Magureanu M, Kettlitz M, Mechanism of C₂ hydrocarbon formation from methane in pulsed microwave plasma. *J. Appl. Phys.*, 2002, 92, 7022–7031.
207. Yang Y. Direct non-oxidative methane conversion by non-thermal plasma: Experimental study. *Plasma Chem. Plasma Process.*, 2003, 23, 283–296.
208. Tarverdi H, Mortazavi Y. Synergetic effects of plasma, temperature and diluant on nonoxidative conversion of methane to C₂+ hydrocarbons in a dielectric barrier discharge reactor. *Iran. J. Chem. Chem. Eng.*, 2005, 24, 63–71.
209. Konno K, Onoe K, Takiguchi Y, Yamaguchi T. Conversion of methane by dielectric barrier discharge plasma using an inner electrode with discharge disks set 5mm intervals. *Chem. Eng. Res. Des.*, 2015;95:144-149.
210. Zhou L, Xue B, Kogelschatz U, Eliasson B. Partial oxidation of methane to methanol with oxygen or air in a non-equilibrium discharge plasma. *Plasma Chem. Plasma Process.*, 1998; 18: 375–393.
211. Matsumoto H, Tanabe S, Okitsu K, Hayashi Y, Suib SL. Selective oxidation of methane to methanol and formaldehyde with nitrous oxide in a dielectric barrier discharge plasma reactor. *J. Phys. Chem.*, 2001;105:5304–08.
212. Tsuchiya T, Iizuka S. *J. Environ. Eng. Technol.*, 2013; 2:35-39.
213. Li Y, Liu CJ, Eliasson B, Wang Y. Synthesis of oxygenates and higher hydrocarbons directly from methane and carbon dioxide using dielectric barrier discharges: product distributions. *Energy Fuels* .2002;16:864 -870.
214. Zhang YP, Li Y, Wang Y, Liu CJ, Eliasson B. Plasma methane conversion in the presence of carbon dioxide using dielectric barrier discharge. *Fuel Process. Technol.*, 2003;83:101–09.
215. Mostaghimi J, Boulos MI, Thermal Plasma Sources: How Well are They Adopted to Process Needs?, *Plasma Chem. Plasma Process* 2015;35:421

216. Pershin L, Chen L, Mostaghimi J. Plasma spraying of metal coatings using CO₂ based gas mixtures. *Journal of thermal spray technology* 2008;17:608-611.
217. Safa S, Ardakan AH, Soucu G. Experimental and thermodynamic comparison between a novel CO₂/CH₄ and oxygen submerged DC thermal plasma for treatment of sebacic acid in basic aqueous solution 2014;4: 2136-47.
218. Rutberg PhG, Nakonechny GhV, Pavlov AV, Popov SD, Serba EO, Surnov AV. AC plasma torch with H₂O/CO₂/CH₄ mix as the working gas for methane reforming. *Journal of Physics D: Applied Physics* 2015; 48:245204
219. CEA, EUROPLASMA, Device for gasifying biomass and organic wastes at a high temperature and with an external power supply for generating a high quality synthesis gas, patent WO 2007/44042559, 2007.
220. Perez-Ramirez J, Kapteijn F, Schoffel K, Moulijn JA. Formation and control of N₂O in nitric acid production - Where do we stand today. *Appl. Catal., B* 2003; 44:117–51.
221. Sistani KR, Jn-Baptiste M, Lovanh N and Cook KL. Atmospheric Emissions of Nitrous Oxide, Methane, and Carbon Dioxide from Different Nitrogen Fertilizers. *J. Environ. Qual* 2011;40:1797–805.
222. Konsolakis M. Recent Advances on Nitrous Oxide (N₂O) Decomposition over Non-Noble-Metal Oxide Catalysts: Catalytic Performance, Mechanistic Considerations, and Surface Chemistry Aspects. *ACS Catal.* 2015;5:6397–421.
223. Centi G, Vazzara F. Selective catalytic reduction of N₂O in industrial emission containing O₂, H₂O and SO₂: behavior of Fe/ZSM-5 catalysis. *Catalysis Today* 1999; 53:683-93.
224. Galle M, Agar DW, Watzenberger O. Thermal N₂O decomposition in regenerative heat exchanger reactors. *Chem. Eng. Sci.* 2001;56:1587 – 95.
225. Atabarut T, Ekinici E. Thermal Treatment of Landfill Leachate and the Emission Control. *J. Environ. Sci. Health. Part A Toxic/ Hazard. Subst. Environ. Eng* 2007;41:1931 – 42.
226. Kameoka S, Suzuki T, Yuzaki K, Takeda T, Tanaka S, Ito S, Miyadera T, Kunimori K. Selective catalytic reduction of N₂O with methane in the presence of excess oxygen over Fe-BEA zeolite. *Chem. Commun.* 2000;745-746.
227. Ates A, Reitzmann A, Hardacre C, Yalcin H. Abatement of nitrous oxide over natural and iron modified zeolites. *Appl. Catal., A* 2011;407:67–75.
228. Liu Z, He C, Chen B, Liu H. CuO-CeO₂ mixed oxide catalyst for the catalytic decomposition of N₂O in the presence of the oxygen. *Catal. Today*, 2017;297:78–83.
229. Chen HL, Lee HM, Chen SH, Chang MB, Yu SJ, Li SN. Removal of Volatile Organic Compounds by Single-Stage and Two-Stage Plasma Catalysis Systems: A Review of the Performance Enhancement Mechanisms, Current Status, and Suitable Applications. *Environ. Sci. Technol* 2009;43:2216–27.

230. Durme JV, Dewulf J, Leys C, Langenhove HV. Combining non-thermal plasma with heterogeneous catalysis in waste gas treatment: A review. *Appl. Catal., B*, 2008;78:324–333.
231. Fan X, Zhu TL, Sun YF, Yan X. The roles of various plasma species in the plasma and plasma-catalytic removal of low-concentration formaldehyde in air. *J. Hazard. Mater* 2011;196:380–85.
232. Wan YJ, Fan X, Zhu TL. Removal of low-concentration formaldehyde in air by DC corona discharge plasma. *Chem. Eng. J* 2011;171:314–19.
233. Fan X, Zhu TL, Wan YJ, Yan X. Effects of humidity on the plasma-catalytic removal of low-concentration BTX in air. *J. Hazard. Mater* 2010;180:616–21.
234. Fan X, Zhu TL, Wang MY, Li XM. Removal of low-concentration BTX in air using a combined plasma catalysis system. *Chemosphere* 2009;75:1301–06.
235. Yu Q, Gao Y, Tang X, Yi H, Zhang R, Zhao S, Gao F, Zhou Y. Removal of NO from flue gas over HZSM-5 by a cycling adsorption-plasma process. *Catal. Commun* 2018;110:18–22.
236. Hu X, Nicholas J, Zhang J, Linjewile TM, Filippis PD, Agarwal PK. The destruction of N₂O in a pulsed corona discharge chamber. *Fuel* 2002;81:1259–68.
237. Zhao GB, Hu XD, Argyle MD, Radosz M. N atom radicals and N-2(A(3)Sigma(+)(u)) found to be responsible for nitrogen oxides conversion in nonthermal nitrogen plasma. *Ind. Eng. Chem. Res.*, 2004;43:5077–88.
238. Mahammadunnisa S, Reddy EL, Reddy PRMK, Subrahmanyam C. A facile approach for direct decomposition of nitrous oxide assisted by non-thermal plasma. *Plasma Processes Polym.*, 2013;10:444–450.
239. Trinh Q, Kim SH, Mok YS. Removal of dilute nitrous oxide from gas streams using a cyclic zeolite adsorption-plasma decomposition process. *Chem. Eng. J.*, 2016;302:12–22.
240. Lee DH, Kim T. N₂O decomposition by catalyst assisted cold plasma, 20th Int. Symp. Plasma Chem., Philadelphia, USA, 2012.
241. Hu H, Huang H, Xu J, Yang Q, Tao G. N₂O decomposed by discharge plasma with catalysts. *Plasma Sci. Technol.*, 2015;17:1043–1047.
242. Austin JM, Smith ALS. Decomposition of N₂O in a glow discharge. *Journal of Physics D: Applied Physics* 1973;6:2236.
243. Bosi FJ, Dobrynin D. Gliding arc plasma assisted N₂O dissociation for mono propellant propulsion. *J. Phys. D: Appl. Phys* 2017;50:025202
244. Fan X, Kang S, Li J, Zhu T. Conversion of dilute (N₂O) in N₂ and N₂- O₂ mixtures by plasma and plasma-catalytic process. *RSC Adv.* 2018;8:26998
245. Jo S, Lee DH, Song YH. Effect of gas temperature on partial oxidation of methane in plasma reforming. *Int J Hydrogen Energy* 2013;38:13643–48.
246. Aslam M, Khalil K, Reinhold AR, John AC, John MP, Eric PG, Andmartha JS. Atmospheric Perfluorocarbons. *Environ. Sci. Technol.* 2003;37:4358–61.

247. Olivier JGJ, Berdowski JM, Peters AHW, Bakker J, Visschedijk AJH, Bloos JJ. Emission data base for global atmospheric research (EDGAR 4.2) 2011
248. Cha I, Lee S, Lee JD. Separation of SF₆ from gas mixtures using gas hydrate formation. *Environ. Sci. Technol.* 2010; 44/16:6117–22.
249. Radoiu M, Hussain S. Microwave plasma removal of sulphur hexafluoride. *Journal of Hazardous Materials.* 2009;164:39–45.
250. Christophorou LG, Olthoff JK, Brunt RJV. Sulfur hexafluoride and the electric power industry. *IEEE Electrical Insulation Magazine*, 1997;13/5: 20–24.
251. U.S. Environmental Protection Agency (USEPA). (2013). Global mitigation of Non-CO₂ greenhouse gases: 2010–2030. Washington DC: USEPA.
252. Lee HM, Chang MB, Wu KY. Abatement of sulfur hexafluoride emissions from the semiconductor manufacturing process by atmospheric-pressure plasmas. *Journal of the Air & Waste Management Association* 2004;54/8:960 – 70.
253. Van Brunt RJ, Herron JT. Plasma chemical model for decomposition of SF₆ in a negative glow corona discharge. *Physica Scripta* 1994;T53:9-29.
254. Wen-Tien T. The decomposition products of sulfur hexafluoride (SF₆): Reviews of environmental and health risk analysis. *Journal of Fluorine Chemistry* 2007: 128/11: 1345–52.
255. Ryan KR, Plumb IC. Gas-phase reactions in plasmas of SF₆ with O₂ in He. *Plasma Chemistry & Plasma Processing* 1988;8:263–80.
256. Shih M, Lee WJ, Tsai, CH. Decomposition of SF₆ in an RF plasma environment. *Journal of the Air & Waste Management Association* 2002; 52: 1274–80.
257. Shih M, Lee WJ, Tsai, Chen CY. Decomposition of SF₆ and H₂S mixture in radio frequency plasma environment. *Industrial & Engineering Chemistry Research.* 2003; 42:2906-12.
258. Joshi AV. Decomposition of SF₆-R134a effluents by RF plasma. *Nuclear Instruments & Methods in Physics Research* 2010;661:S245–48.
259. Kabouzi Y, Moisan M, Rostaing, JC, Trassy C, Guérin D, Kéroack D, Zakrzewski Z. Abatement of perfluorinated compounds using microwave plasmas at atmospheric pressure. *Journal of Applied Physics* 2003;93:9483 – 96.
260. Ahmadi Z, Khani MR, Kooshki S, Mirzajani F, Shokri B. Investigation of variation power and additive gas effect on the SF₆ destruction using atmospheric microwave plasma torch[J]. *IEEE Transactions on Plasma Science* 2011;39:1834 – 41.
261. Kim JH, Cho CH, Shin DH, Hong YC, Shin YW. Abatement of fluorinated compounds using a 2.45GHz microwave plasma torch with a reverse vortex plasma reactor. *Journal of Hazardous Materials* 2015;294:41–46.
262. Nagai A, Ohyama R. An experimental study on SF₆ gas decomposition by high-voltage pulsed discharge. *IEEE Conference on Electrical Insulation and Dielectric Phenomena* 2005; 681–684.

263. Zhuang Q, Clements B, Mcfarlan A. Decomposition of the most potent greenhouse gas (GHG) sulphur hexafluoride (SF₆) using a dielectric barrier discharge (DBD) plasma. *Canadian Journal of Chemical Engineering* 2014;92(1):32–35.
264. Zhang R, Wang J, Cao, X, Hou H. Decomposition of potent greenhouse gases SF₆, CF₄ and SF₅CF₃ by dielectric barrier discharge. *plasma science & technology* 2016;18: 388–93.
265. Shen Y, Huang L, Zhang R. Decomposition of SF₆ by dielectric barrier discharge. *Environmental Chemistry* 2007; 26: 275–79.
266. Nanjo Y, Ohyama R. An experimental study on vacuum-ultraviolet photochemical reaction to non-thermal plasma oxidized SF₆ gases. *IEEE Conference on Electrical Insulation and Dielectric Phenomena* 2005; 689–92.
267. Cui Z , Zhang X , Yuan T , Xingya P , Luo Y , Tang J. Plasma-assisted abatement of SF₆ in a dielectric barrier discharge reactor: investigation on the effect of packing materials, *J. Phys. D: Appl. Phys* 2019; 53: 025205
268. Han SH, Seon HS, Shin PK, Park DW. Conversion of SF₆ by thermal plasma at atmospheric pressure. 2009
269. Liu JL, Park HW, Chung WJ, Park DW. High efficient conversion of CO₂ in AC pulsed tornado gliding arc plasma. *Plasma Chem Plasma Process* 2015;36:437-49.