



HAL
open science

Gate reflectometry in dense quantum dot arrays

Fabio Ansaloni, Heorhii Bohuslavskiy, Federico Fedele, Torbjørn Rasmussen, Bertram Brovang, Fabrizio Berritta, Amber Heskes, Jing Li, Louis Hutin, Benjamin Venitucci, et al.

► **To cite this version:**

Fabio Ansaloni, Heorhii Bohuslavskiy, Federico Fedele, Torbjørn Rasmussen, Bertram Brovang, et al.. Gate reflectometry in dense quantum dot arrays. *New Journal of Physics*, 2023, 25 (3), pp.033023. 10.1088/1367-2630/acc126 . hal-04051795

HAL Id: hal-04051795

<https://hal.science/hal-04051795v1>

Submitted on 20 Sep 2024

HAL is a multi-disciplinary open access archive for the deposit and dissemination of scientific research documents, whether they are published or not. The documents may come from teaching and research institutions in France or abroad, or from public or private research centers.

L'archive ouverte pluridisciplinaire **HAL**, est destinée au dépôt et à la diffusion de documents scientifiques de niveau recherche, publiés ou non, émanant des établissements d'enseignement et de recherche français ou étrangers, des laboratoires publics ou privés.



Distributed under a Creative Commons Attribution 4.0 International License



PAPER

Gate reflectometry in dense quantum dot arrays

Fabio Ansaloni^{1,4}, Heorhii Bohuslavskyi^{1,4}, Federico Fedele¹ , Torbjørn Rasmussen¹, Bertram Brovang¹, Fabrizio Berritta¹ , Amber Heskies¹, Jing Li² , Louis Hutin³, Benjamin Venitucci², Benoit Bertrand³, Maud Vinet³, Yann-Michel Niquet², Anasua Chatterjee¹ and Ferdinand Kuemmeth^{1,*} 

¹ Center for Quantum Devices, Niels Bohr Institute, University of Copenhagen, 2100 Copenhagen, Denmark

² Université Grenoble Alpes, CEA, IRIG, MEM-L Sim, F-38000 Grenoble, France

³ Université Grenoble Alpes, CEA, LETI, MINATEC Campus, F-38000 Grenoble, France

⁴ These authors contributed equally to this work.

* Author to whom any correspondence should be addressed.

E-mail: kuemmeth@nbi.dk

Keywords: spin qubits, reflectometry, quantum dots

OPEN ACCESS

RECEIVED

2 November 2022

REVISED

13 February 2023

ACCEPTED FOR PUBLICATION

3 March 2023

PUBLISHED

22 March 2023

Original Content from
this work may be used
under the terms of the
[Creative Commons
Attribution 4.0 licence](https://creativecommons.org/licenses/by/4.0/).

Any further distribution
of this work must
maintain attribution to
the author(s) and the title
of the work, journal
citation and DOI.



Abstract

Silicon quantum devices are maturing from academic single- and two-qubit devices to industrially-fabricated dense quantum-dot (QD) arrays, increasing operational complexity and the need for better pulsed-gate and readout techniques. We perform gate-voltage pulsing and gate-based reflectometry measurements on a dense 2×2 array of silicon QDs fabricated in a 300 mm-wafer foundry. Utilizing the strong capacitive couplings within the array, it is sufficient to monitor only one gate electrode via high-frequency reflectometry to establish single-electron occupation in each of the four dots and to detect single-electron movements with high bandwidth. A global top-gate electrode adjusts the overall tunneling times, while linear combinations of side-gate voltages yield detailed charge stability diagrams. To test for spin physics and Pauli spin blockade at finite magnetic fields, we implement symmetric gate-voltage pulses that directly reveal bidirectional interdot charge relaxation as a function of the detuning between two dots. Charge sensing within the array can be established without the involvement of adjacent electron reservoirs, important for scaling such split-gate devices towards longer $2 \times N$ arrays. Our techniques may find use in the scaling of few-dot spin-qubit devices to large-scale quantum processors.

1. Introduction

Spin-based quantum computing based on gate-controlled silicon quantum dots (QDs) is rapidly evolving [1], underscored by recent devices with single- and two-qubit fidelities exceeding 99% [2–4], all fabricated in non-industrial cleanrooms. Devices fabricated by industrial 300 mm-wafer processes already show coherent single-spin rotations [5–8], with further efforts spanning planar Si/SiGe heterostructures [9], planar Si/SiO₂ interfaces [7, 10], fully-depleted silicon-on-insulator (FDSOI) silicon nanowires [11, 12] as well as ²⁸Si/SiO₂ fins [8]. While these approaches offer the prospects of high yield and high device uniformity, device geometries are more restricted relative to academic devices, for example due to foundry preferences for photolithography over electron-beam lithography, etching over lift-off processes, and other considerations.

Scaling spin qubits from few-qubit circuits towards fault-tolerant quantum processors will likely involve two-dimensional arrays of singly-occupied QDs [13, 14], sufficiently dense to allow two-qubit gates based on Heisenberg spin exchange. Two-dimensional arrays have been investigated in gallium arsenide [15–18] and germanium [19], all fabricated by electron-beam lithography in academic cleanrooms with dedicated proximal charge sensors that enabled the operation of these dot arrays in their one-electron regimes. A recent proposal suggests the use of sparse spin qubit arrays, in which pairs of electrons are controlled close to each other only when required [20], although experimental advances are needed to implement and control such devices.

In this work, we focus on controlling charge transitions in a foundry-fabricated 2×2 silicon quadruple dot without the need for additional charge sensors. Using gate-based high-frequency reflectometry, we

demonstrate charge readout, dispersive sensing, and single-electron occupation of each of the four QDs. We then acquire charge stability diagrams with and without compensating for capacitive crosstalk within the array, generalizing negatively compensated control voltages introduced in [21] to positively compensated control voltages. This allows the acquisition of charge stability maps over wide gate-voltage regions of the qubit array, which may be useful for exploring spin qubit operations in multi-electron configurations [22]. We also extend pulsed-gate experiments from [21] by designing symmetric gate-voltage pulses that allow the detection of forward and reverse interdot charge relaxation processes, as a function of dot detuning. (In finite magnetic fields, we find no evidence for Pauli spin blockade, although similar devices have recently enabled spin-relaxation experiments [23–25]). Finally, we show that charge sensing within the array is possible without involvement of the source or drain reservoirs. To our knowledge, this has not been reported in literature, and may inspire dense arrays of spin qubits without the need to route ohmic channels across the quantum processor. Our measurements are supported by a constant interaction model that captures multi-dot Coulomb blockade and a $\mathbf{k} \cdot \mathbf{p}$ model that confirms an overall dependence of tunnel barriers on a top-gate voltage. Overall, our techniques utilize the strong capacitive couplings within the dense qubit array and may be useful for scaling current spin-qubit devices to larger QD arrays.

Section 2 introduces the device and pulsed-gate reflectometry setup. Section 3.1 explains how reflectometry off one gate electrode allows detection of the first electron for all four QDs, albeit not simultaneously. Section 3.2 introduces compensated control voltages for acquiring multi-dot charge stability diagrams via radio-frequency reflectometry. Section 3.3 presents the time-domain pulsed-gate measurements revealing forward and reverse charge relaxation processes across an interdot transition. Section 3.4 implements a hybridized double dot within the array, such that nearby charge transitions can be sensed dispersively without the need for exchanging electrons with a reservoir.

2. Methods

Figure 1(a) shows the device chip wirebonded to a high-frequency printed-circuit-board chip carrier that also provides reflectometry functionalities [27] via a surface-mounted inductor L , a coupling capacitor C_C , and a bias resistor R_B . An undoped silicon nanowire of width $W = 70$ nm and thickness $t_{Si} = 7$ nm is connected to highly-doped source and drain contacts (figure 1(b)). Four accumulation gate electrodes G_{1-4} induce electrostatically-defined QDs under each gate for sufficiently positive gate voltages [21]. Gate lengths $L_G = 32$ nm and vertical and horizontal spacings $S_V = S_H = 32$ nm are defined by hybrid deep-ultraviolet and electron-beam lithography and silicon-nitride spacers [28, 29]. The gate stack comprises a 6 nm SiO_2 gate dielectric capped by 5 nm TiN and 50 nm doped polycrystalline silicon, as shown in figure 1(c) for a similar device.

Figure 1(d) summarizes the wiring between room temperature electronics and the device located inside a cryofree dilution refrigerator. The sample holder at 0.05 K allows measurements of source-drain current (I , measured via thermalizing filters [26]) and radio-frequency measurements via port 1 (RF_{in}) and port 2 (RF_{out}), building on earlier gate-based reflectometry [30].

A SG383 vector source generates a reflectometry carrier that is attenuated and phase-shifted at room temperature and further attenuated inside the cryostat (36 dB distributed between 50, 4, and 1 K) before passing a directional coupler (MC ZFDC-20-5-S). The signal reflected from the LC resonator is amplified at 4 K (35 dB, Weinreb CITLF1) and further processed at room temperature for demodulation, amplification, low-pass filtering (SR560) and digitization (AlazarTech ATS9360). Here, $L = 820$ nH is a surface-mounted copper inductor (Coilcraft 1206CS-821XJL) and C constitutes a parasitic capacitance to ground associated with bond wires and metal tracks (not shown in figure 1(d), estimated 0.85 pF from the observed resonance at 191 MHz). The 191 MHz carrier (-75 dBm incident on L) results in a demodulated background amplitude of 0.2 V. By adjusting the phase shifter, the demodulated quadrature V_H is reduced to approximately 0 and then changes by typically 0.01 V when the sensor dot is active, corresponding to a change in the phase of the reflected carrier of approximately 2° .

Side gates $G_{1,2,3}$ are wirebonded to bias-tees so that low-frequency tuning voltages and high-frequency control pulses can be applied simultaneously. The high-bandwidth sample holder is available for multi-channel quantum electronics experiments [26] and features high-frequency grounds (SMD capacitors to ground) on all low-frequency channels, including source and drain wires. For fast voltage pulses $V_{1,2,3}^F(t)$, coaxial cables are attenuated by 28 dB distributed between 50, 4, 1 and 0.05 K. Low-frequency (high-frequency) control voltages are generated by a high-resolution multi-channel digital-to-analog converter QDevil (QDAC) [26] (Tektronix AWG5014C), and no external magnetic field is applied unless otherwise specified.

Despite the small number of gate electrodes, tunnel rates can be adjusted *in situ* via a 200-nm-long copper electrode (top gate) that runs across the device center 300 nm above the nanowire (see appendix A).

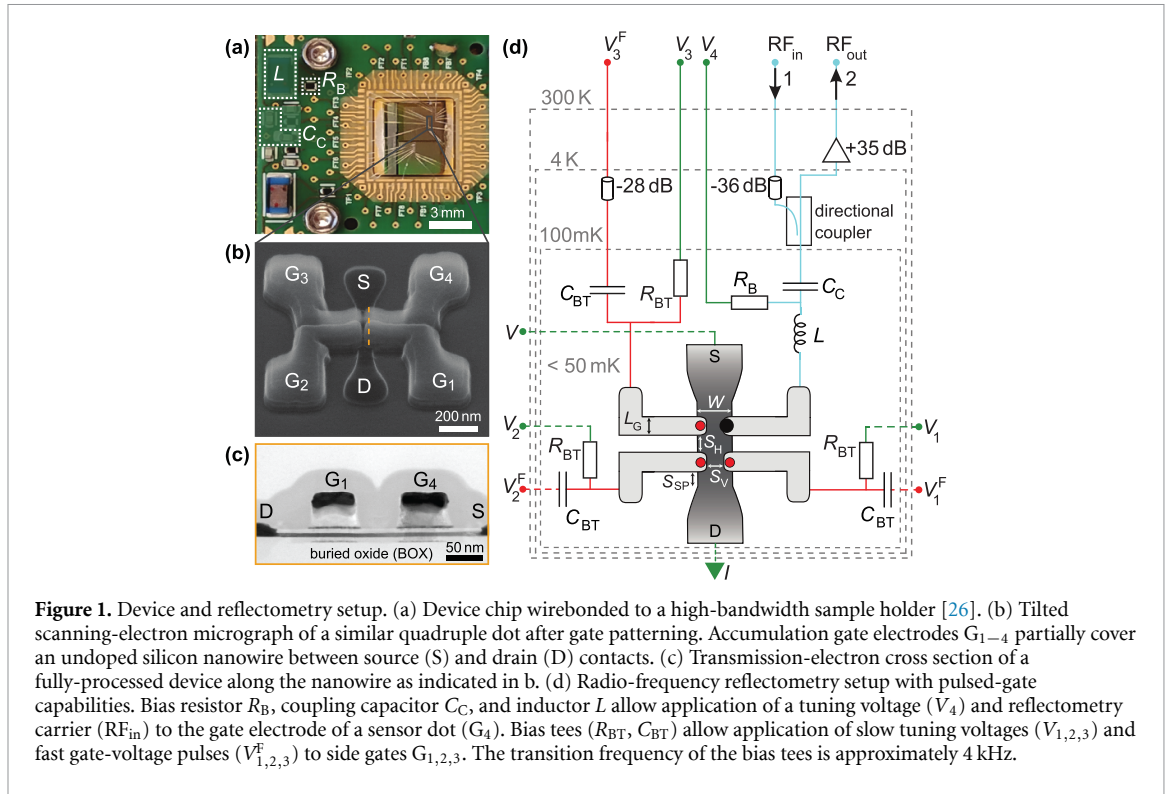

Its wiring is identical to that of the low-pass-filtered source and drain wiring (not shown in figure 1(d)). Alternative barrier tuning via a highly-doped silicon layer below the buried oxide (BOX) was demonstrated in [31] for similar nanowire devices.

The split-gate device studied here was recently used to demonstrate various single-electron operations at $B = 0$, including the tuning of tunneling rates by the top-gate voltage (V_{tg}) and the spatial permutation of two electrons [21], as well as the implementation of triggered acquisition and autonomous measurement of Coulomb blockade boundaries [32]. Similar split-gate arrays from the same foundry demonstrated capacitive coupling between two 2×2 arrays [33, 34], microwave spectroscopy of double-dot states [35], as well as a large dispersive coupling to a microwave resonator [36]. In all cases, including our results below, the relatively large capacitive couplings arising from the FDSOI nanowire geometry plays an advantageous role.

3. Results and discussion

3.1. Single-electron occupations

Figure 2 shows stability diagrams for the longitudinal, diagonal, and transverse double quantum dots (DQDs) indicated in its insets. Source and drain contacts are grounded for reflectometry measurements. Discrete capacitive shifts of Coulomb peaks associated with one dot—serving as a charge sensor for the other dot—clearly reveal the threshold voltage for the first and second electron in all four dots.

To achieve high-visibility Coulomb oscillations in $V_H(V_4)$, QD_4 is first configured in the multi-electron regime (9–12 electrons) [23, 24, 36]. Non-participating dots remain empty by applying 0 V to their gates. Multi-electron occupation increases the coupling strength of the LC resonator to QD_4 and the tunnel rate between QD_4 and its reservoir, thereby facilitating dispersive sensing [37]. The large capacitive shift arising from the first and second electron on QD_1 (red dashed lines in figure 2(a)) is qualitatively consistent with the relatively large dot-to-dot capacitance inferred from triple-dot measurements in figure 3 (see capacitance values in appendix C).

The reflectometry signal does not reveal single-electron charging of QD_4 , likely due to its small tunnel rate relative to the reflectometry frequency (191 MHz) [37]. Presumably, other groups encountered the same limitation in similar devices and made no statements about single-electron occupation of their sensor dots [24, 38]. In figure 2(d), we therefore configure QD_3 in the multi-electron regime, yielding sufficient tunnel coupling to its reservoir and sufficient capacitive coupling to the reflectometry gate G_4 to yield visible Coulomb oscillations in $V_H(V_3)$. In this way, discrete capacitive shifts of these Coulomb peaks indicate the first and second electron on QD_4 (black dashed lines). For this measurement, QD_1 and QD_2 were kept empty ($V_{1,2} = -0.2$ V).

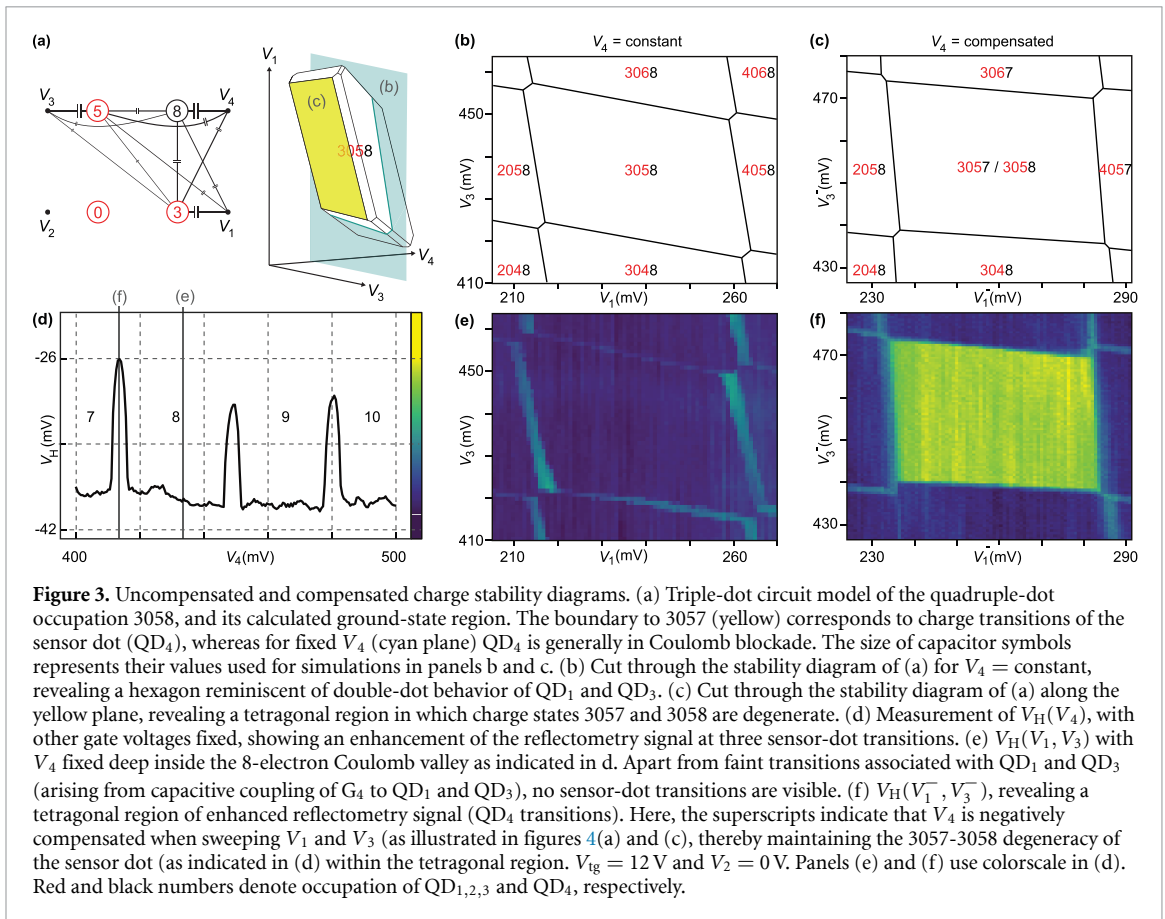
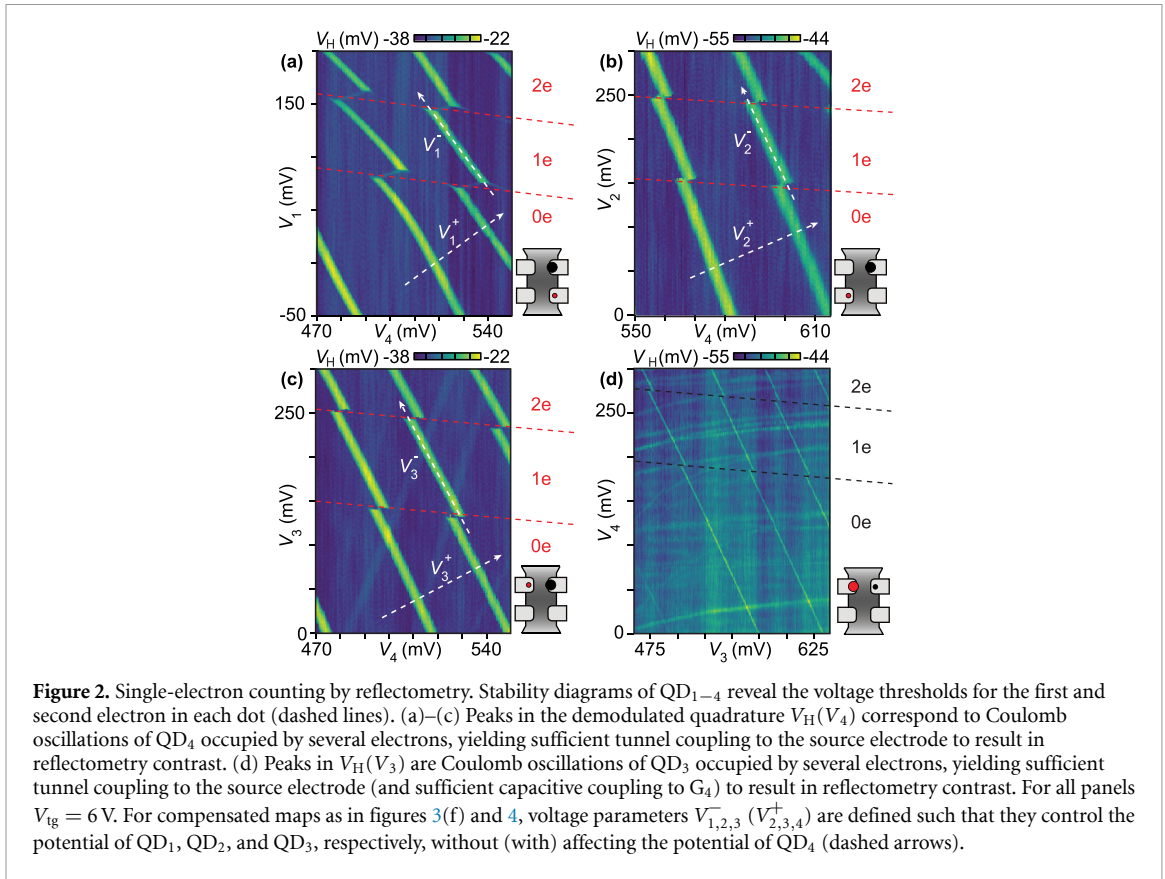

The threshold voltages observed in figure 2 for the first electron in each dot are not expected to be identical, due to different capacitive crosstalk between the highly-biased sensor gate (G_4 for panels a–c, G_3 for panel d) to the neighboring dots. After accounting for such capacitive effects (as done in the Supplementary Information of [21]), a spread of approximately 50 mV remains, comparable the observed spread among different cool downs of the same device. Recent simulations that go beyond the model in appendix B suggest charged defects (such as dangling bonds) under or around the gates as a possible explanation [39].

3.2. Charge stability diagrams using compensated control voltages

The sensitivity of Coulomb oscillations of QD_4 (from now on referred to as sensor dot) to nearby charge rearrangements can be further utilized by applying compensated control voltages, i.e. linear combinations of native gate voltages $V_{1,2,3,4}$ such that changes applied to compensated voltages do or do not change the chemical potential of the sensor dot [40, 41]. Such compensated control voltages are visualized in figure 2 as arrows. Experimentally, they are implemented by calibrating capacitive matrix elements α_{4i} such that V_4 compensates for electrostatic cross coupling between gates G_{1-3} and QD_4 , i.e. by updating voltage $V_4 \equiv V_4^o + \sum_{i=1}^3 \alpha_{4i}(V_i - V_i^o)$ whenever voltages V_{1-3} are changed relative to a chosen operating point (V_1^o, V_2^o, V_3^o) . The choice of positive (negative) values for α_{4i} is indicated by adding a superscript $+(-)$ to the respective control voltage, with α_{4i} listed in appendix D. Using this compensation, and by setting the desired operating point of the sensor dot via V_4^o , the associated reflectometry signal V_H becomes sensitive to charge rearrangements within the array.

Positive compensation is useful for acquiring large stability diagrams of QD_1 , QD_2 , and QD_3 , as it increases the density of Coulomb peaks associated with QD_4 and thereby facilitates the identification of charging events. (This can be seen by comparing the density of sensor peaks in figure 4(a) with that in figure 2.)

Negative compensation, for accurate choices of V_i^o and α_{4i} , has an intuitive physical interpretation: sitting on a Coulomb peak, as long as the (enhanced) reflectometry signal is unchanged, there are no charge rearrangements within the quadruple dot except for a continual exchange of electrons between QD_4 and its reservoir. This allows the study of charge state boundaries, demonstrated below for a triple-dot configuration, relevant, for instance, for the spatial permutation of isolated fermions [21] or the implementation of exchange-only qubits [42].

Figure 3(a) shows a capacitive circuit model for the charge occupation 3058, and its simulated ground-state region in gate-voltage space. Here, the i th digit indicates the number of electrons on the i th dot. In this model, the empty dot (QD_2) is ignored, as its physical presence can be absorbed into the capacitance values of the triple-dot circuit. The triple-dot constant interaction model is appropriate for sufficiently small tunnel couplings within the array [43]. (For dispersive reflectometry, we like interdot tunnel couplings to be sufficiently large to show up in the reflectometry signal, hence we occupy QD_1 (QD_3) by 3 (5) electrons, rather than configuring them in the one-electron regimes.) Points representing the 3057–3058 ground-state degeneracy are shaded in yellow, indicating that a compensated scan of this region is expected to yield enhanced reflectometry signals arising from QD_4 . In contrast, a native cut at fixed V_4 is shaded in blue, indicating that a low reflectometry background is expected due to all ground-states in this region having a fixed charge on QD_4 . Using capacitance values inferred from measurements, simulations reveal that ground-state boundaries can appear hexagonal (as in the native plane of figure 3(b)) or tetragonal (as in the negatively compensated plane of figure 3(c)).

To verify this observation experimentally, we set V_i^o and α_{4i} appropriate for configuring the device in the 3058 occupation and initially acquire uncompensated Coulomb oscillations associated with QD_4 (figure 3(d)). Fixing V_4 inside the 8th Coulomb valley then yields uncompensated stability diagrams as in figure 3(e). As expected, no Coulomb peaks of QD_4 are visible (note colorscale in figure 3(d)), but faint hexagonal features are clearly visible that correspond to smaller dispersive signals arising from charge transitions of QD_1 and QD_3 [44]. In contrast, choosing an operating point on the 7th sensor peak yields negatively compensated charge stability diagrams as in figure 3(f), dominated by a tetragonal region with a V_H intensity consistent with the sensor peak indicated in figure 3(d).

Well-known for capacitively coupled triple dots [45, 46], some charge state boundaries cannot be crossed by one-electron transitions alone and require two single-electron movements or two-electron cotunneling events, such as transitions 2058–3067 and 3048–4057 in figure 3(c). Surprisingly, these higher-order multi-electron dynamics clearly manifest themselves in the dispersive signal, at least for the high top-gate voltage used in figure 3(f).

To show the practical differences between positive and negative compensation, we plot in figure 4(b) a negatively compensated charge stability map of a transverse double dot (i.e. QD_3 deactivated) and in figure 4(a) a positively compensated map containing the same charge states (in both cases, QD_4 is operated

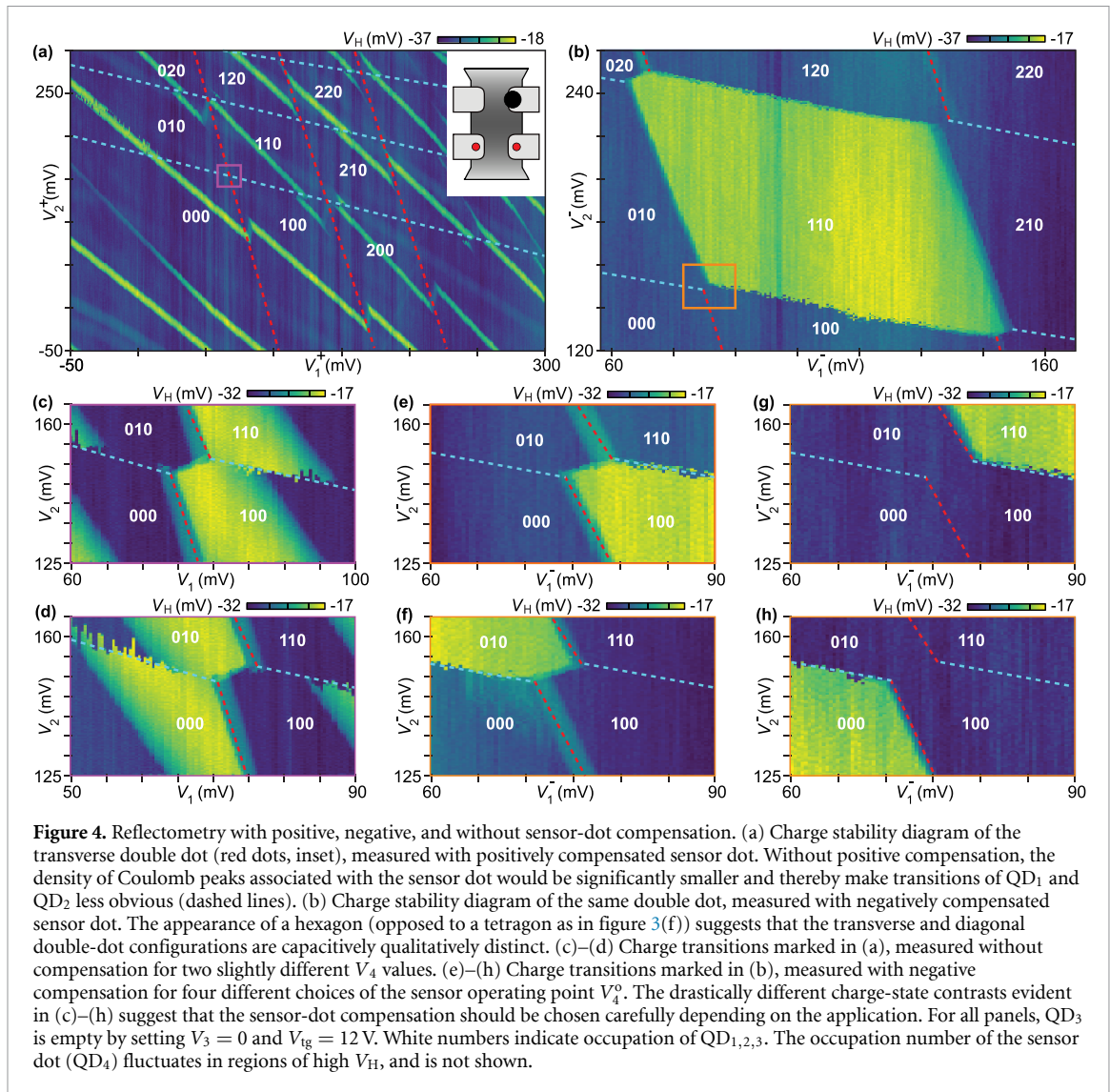

in the multi-electron regime to enhance V_H). The high density of sensor peaks in figure 4(a) makes it easy locate the degeneracy points associated with QD₁ and QD₂ (dashed lines), whereas the exact boundaries of individual charge states remain elusive. In contrast, figure 4(b) yields the exact shape of a particular charge-state boundary, from which device capacitances analogous to figure 3(a) can be extracted.

The observation of a hexagonal region in figure 4(b), opposed to a tetragonal region as in figure 3(f), indicates that the two array configurations are represented by triple-dot circuits that are qualitatively different in terms of their effective capacitances.

Compared to double dots with proximal charge sensors [30], which can also be viewed as triple dots, the relatively strong capacitive coupling between sensor dot and other dots in the 2×2 array also makes *uncompensated* charge stability diagrams qualitatively different, in the sense that only two or three charge states near a double-dot triple point can be distinguished. This is evident in figure 4(c), where certain charge transitions like 000-010 cannot be distinguished despite the use of an intentionally power-broadened sensor peak. This sensitivity is useful when only one charge transition needs to be detected, in which case its visibility can be optimized or even reversed by adjusting the sensor operating point. For example, raising V_4 by only 4 mV yields the opposite V_H contrast for the same 100-010 transition (figure 4(d)).

Negative compensation suffers from a similar ‘strong coupling’ problem, making it difficult to distinguish multiple charge states within one charge stability map. Between figures 4(e) and (h), only V_4^0 was adjusted, resulting in an enhancement of V_H for four different charge states.

Recently, a different method to mitigate the strong capacitive coupling between dots achieved charge sensing by rastering native gate voltages and plotting the Coulomb-peak position of the sensor dot (quantified as a change in sensor-dot voltage) [38].

3.3. Pulsed-gate charge-relaxation measurements

The ability to acquire charge stability diagrams facilitates the construction of gate-voltage trajectories that manipulate the charge configuration of the quadruple dot on nanosecond time scales. High-frequency reflectometry performed concurrently with gate-voltage pulsing allows monitoring of the charge dynamics on microsecond time scales (see appendix E for an analysis of the bandwidth and signal-to-noise ratio (SNR) achieved in this work). This allows detailed charge-relaxation experiments, suitable to detect Pauli spin blockade and investigate spin physics in such devices [23–25]. Pauli spin blockade between two QDs typically manifests itself as asymmetric charge relaxation rates in small magnetic fields; in the simplest case, the (20) spin-singlet state of a DQD can transition quickly into a (11) state, whereas (11) spin-triplet states only slowly relax to (20) (here, the Pauli exclusion principle requires a spin-non-conserving transition). In more complicated cases, such as in multi-electron regimes, additional considerations may become important [23, 47].

To illustrate the implementation of pulsed-gate experiments that reveal bidirectional interdot relaxation dynamics, we activate G_2 and G_3 as a DQD and continue to use QD_4 as a sensor dot. To increase tunnel rates, we set $V_{tg} = +30$ V and keep QD_1 empty by setting $V_1 = -0.4$ V.

Figure 5(a) shows the DQD charge stability diagram near the (20)-to-(11) interdot transition in the absence of gate-voltage pulses, using an uncompensated sensor dot. This diagram is used to define a detuning parameter, ε , as shown, with $\varepsilon = 0$ defined at the ground-state degeneracy between (20) and (11). The voltage trajectory indicated by magenta arrows can be traced out in time by repeatedly applying suitable waveforms $V_2^F(t)$ and $V_3^F(t)$ (figure 5(b)), while fixing the DC values V_2 and V_3 at $\varepsilon = 0$. This works because the voltage trajectory is a closed loop (here with a period of 160 μ s) with ramp times and ramp amplitudes chosen in such a symmetric manner that the DC blocks of the cryostat (i.e. capacitors C_{BT}) do not introduce an effective time-averaged offset voltage on G_2 and G_3 . Averaging $V_H(t)$ over many gate-voltage loops then results in the row $\varepsilon = 0$ of figure 5(c). Other rows in figure 5(c) are obtained in a similar manner by stepping V_2 and V_3 along the ε -axis in figure 5(a) [48]. For each value of ε , $V_H(t)$ is sampled at 100 $MS\ s^{-1}$ and averaged over 500 loops.

The bidirectional charge relaxation diagram in figure 5(c) is of practical value. Between 60 and 80 μ s, the gate-voltage trajectory ramps from the first measurement point in (20) (M_1) to the (10) configuration to refresh one electron (R_2), before preparing the system in the (20) configuration (P_2). The appearance of three sharp features within 60–80 μ s and their weak dependence on ε is of diagnostic value, indicating, for example, that no charge switches or drift of the sensor dot occurred during these acquisitions. Physical insight into interdot relaxation mechanisms is provided by inspecting the ε -dependence of $V_H(t)$ within the first measurement segment (0–60 μ s, for (11)-to-(20) processes) and within the second measurement segment (80–140 μ s, for reverse processes from (20) to (11)). For example, the ground-state to ground-state transition at M_1 (blue marker) appears equally fast as the ground-state to ground-state transition at M_2 (red marker), showing no sign of Pauli spin blockade. Similar fast ground-state to excited-state transitions appear at discrete values of ε (see for example green and orange marker), indicating perhaps that the orbital level structure within the G_2 and G_3 dots are discrete and differ from each other. For detunings in between such relaxation ‘hotspots’, relaxation is observed to be slower, likely due to inelastic decays involving evanescent-wave Johnson noise or phonons [49]. The instantaneous relaxation near $\varepsilon = 0$ (in the regions of the gray and maroon marker) likely arises not from interdot tunneling, but from relaxation via the source and drain reservoirs, as such processes are energetically allowed if V_2 and V_3 are chosen sufficiently close to $\varepsilon = 0$. This provides information about the relative heights of tunnel barriers that define the DQD.

We have acquired charge relaxation diagrams similar to figure 5(c) for various in-plane magnetic fields, applied parallel to the silicon channel, ranging from $B = 0$ T to 2 T, with various ramp rates and ramp amplitudes, without observing any clear evidence for spin or valley physics.

Overall, the spin-valley and orbital physics of QDs in etch-defined split-gate FDSOI devices is less explored and poorly understood relative to gate-defined planar SiMOS and Si/SiGe devices. Generally, small valley splittings make it more difficult to observe spin blockade, although progress in detection methods have been reported for Si/SiGe devices [50, 51]. One complication is the low symmetry of the confinement potential in FDSOI nanowires, arising from a combination of structural and electrical confinements (leading to the formation of ‘corner’ dots as shown in figure 7). This makes the prediction of valley splittings more difficult, especially in the presence of disorder due to charge traps and interface roughness [39], as the valley(-orbit) mixing depends on details of the wave functions at the interatomic length scale [52, 53]. Another complication one may need to consider is the effect of Coulomb correlations when going from a singly occupied to a doubly occupied dot (as in the (11)-to-(20) transition). In particular, Coulomb repulsion tends to split apart electrons in doubly occupied elongated dots such as corner dots. Recent simulations show that the formation of such ‘Wigner molecules’ mixes different single-particle orbitals much more effectively than different valleys [54]. This significantly reduces singlet-triplet splittings that (in the

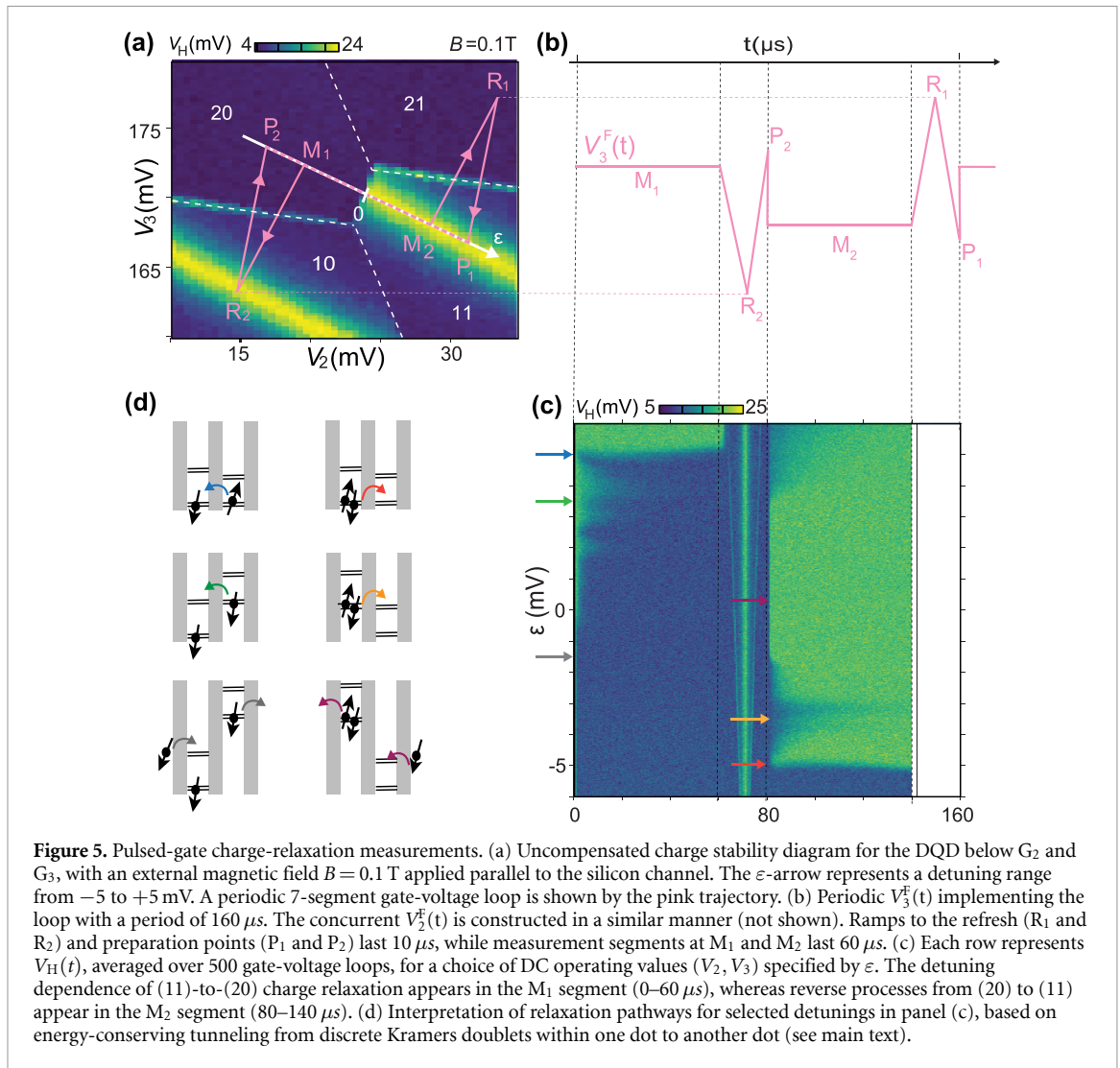

noninteracting picture) are dominated by an orbital excitation, but has weaker effects on singlet-triplet splittings that are dominated by a valley excitation, unless there is strong enough valley-orbit coupling [54, 55]. To look for such effects experimentally, one could use pulsed-gate spectroscopy of excited states to systematically compare one-electron and two-electron orbital excitations of the same dot [56]. For these reasons, we expect that the application of our reflectometry and pulsed-gate techniques to different charge occupations and to more samples with different gate lengths and tunnel rates can provide more physical insights and help the development of spin-qubit functionalities.

3.4. Charge sensing without reservoirs

When scaling from 2×2 devices to longer $2 \times N$ arrays, the source and drain reservoirs will eventually be too distant to support charge sensing within the bulk of the array. We address this challenge by demonstrating that charge sensing is possible without exchanging electrons with the leads. Our technique is based on creating a hybridized double dot within the array (figure 6(a)), whose quantum capacitance is sensitive to nearby charges and can be detected as a dispersive shift in the reflectometry signal [57]. We show this in our 2×2 device by activating two dots as a sensing DQD and the other two dots as qubit dots.

To create the sensing DQD, the top gate is set to $+30$ V and QD_4 is populated by 6–7 electrons. In this regime, the interdot transition between QD_4 and QD_1 hybridizes charge states on both dots and gives rise to an enhanced reflectometry signal (black star in figure 6(b)). Its sensitivity to nearby charges becomes evident by sweeping G_2 vs. G_3 , as done in figure 6(c). The observed honeycomb pattern in V_H indicates that the sensor DQD not only senses changes to the total charge in the qubit array (note the strong contrast between (02) and (12), for example), but also inter-qubit charge transitions (such as (02) to (11)).

Ultimately, future $2 \times N$ devices may benefit from reconfigurable dots, serving as qubit sites at some times and employed for readout or charge sensing at other times. Our gate-based DQD reflectometry technique may simplify such applications, as it does not require proximal reservoirs or dedicated sensor dots.

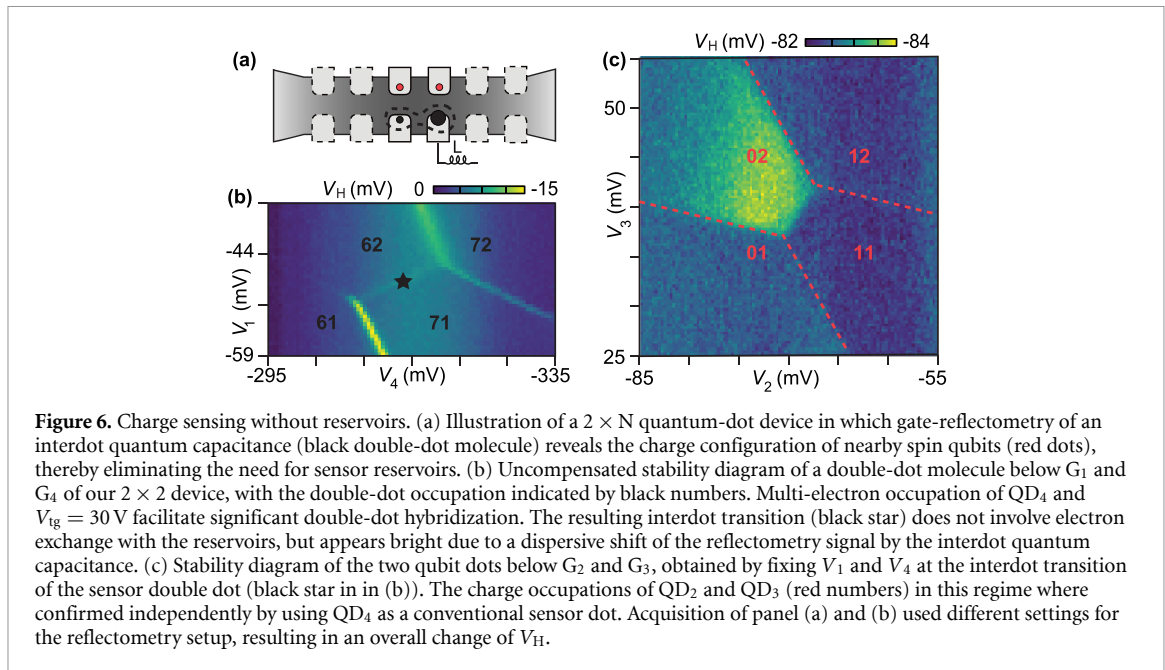

4. Conclusion

This work demonstrates gate-based reflectometry measurements of various few-electron charge states in a 2×2 quadruple dot implemented by 300 mm-wafer foundry fabrication. The strong mutual capacitances within the densely-packed (64 nm gate pitch) array of silicon QDs allows detection of single-electron tunneling in all four dots using only a single LC resonator, wirebonded to one of the four side gates and monitored by radio-frequency reflectometry.

Positive and negative compensation of the sensor dot potential yields convenient multi-dot stability diagrams with qualitatively distinct charge-state polytopes, as exemplified for a triple-dot configuration. Application of periodic, symmetric gate-voltage loops allow the acquisition of charge relaxation diagrams containing forward and reverse interdot tunneling within the same acquisition. This may help in the search for Pauli rectification and spin-valley selection rules, although in the present sample we have not found evidence for Pauli blockade. Finally, we demonstrate that the voltage-dependent hybridization between dots can be used to detect charge states of other dots, providing a route towards gate-based charge sensing in large $2 \times N$ arrays that does not require electron reservoirs or dedicated sensor dots.

Further improvements in bandwidth, SNR, and scalability may be possible by the use of Josephson parametric amplifiers [58, 59], better impedance matching [60], or integration with cryogenic control electronics [61, 62]. Improved device geometries may harness individual control of tunnel barriers through advancements in three-dimensional very-large-scale integrated-circuit (3D VLSI) fabrication technologies [12]. Leveraging large gate capacitances and electrically-driven electron spin resonance [53] may then spark diverse applications for foundry-fabricated devices in circuit quantum electrodynamics [36], quantum simulations, and spin-based quantum information processing.

Data availability statement

The data cannot be made publicly available upon publication because they are not available in a format that is sufficiently accessible or reusable by other researchers. The data that support the findings of this study are available upon reasonable request from the authors.

Acknowledgments

We thank Silvano De Franceschi for the coordination of samples. This work received funding from EU Grant Agreements Nos. 951852, 688539, 676108, and 323841. H B and F A contributed equally to this work.

Appendix A. Tunability of quadruple dot by top gate: modeling and experiment

We demonstrate theoretically and experimentally the overall tunability of tunneling rates between dots via the global top gate. Informed by the measured device (the schematic cross-section of the modeled device is shown in figure 7(a)), our $\mathbf{k} \cdot \mathbf{p}$ model considers an accurately-sized nanowire together with its surroundings: source and drain reservoirs, gate electrodes, gate spacers and BOX substrate. After self-consistently solving the potential in the device in the Thomas–Fermi approximation, the energies and wave functions of the tunnel-coupled single-electron QDs are computed with an anisotropic effective mass method (see appendix B). Figure 7(b) shows the longitudinal $t_{||}$, transverse t_{\perp} , and diagonal t_d tunnel couplings as a function of top-gate voltage, with wavefunctions visualized in panels c–e.

While t_{\perp} and t_d strongly depend on V_{tg} , $t_{||}$ shows a weaker dependence likely due to the short spacer S_H and the larger local screening arising from the geometry of adjacent wrap-around gate electrodes. Interestingly, t_{\perp} is small at low top-gate voltages, becomes comparable to $t_{||}$ at $V_{tg} \approx 5$ V and is an order of magnitude larger at $V_{tg} = 20$ V, suggesting the use of global top gates to tune the ratio of transverse and longitudinal couplings ($t_{\perp}/t_{||}$).

Independent simulations in [34] for similar devices also found a significant effect of the top gate. Comparison between simulations and experimental data (tunneling times for different values of V_{tg} are reported in [21]) are, however, made difficult by the lack of knowledge of the specific disorder (charged traps and interface roughness) under the spacers [39]. The tunneling rates are, indeed, exponentially sensitive to fluctuations of the barrier height. The present simulations, which assume continuous distributions of charges at the interfaces, only account for the average effect of the traps on the potential in the barriers. A more quantitative modeling of the tunneling rates would require a detailed knowledge of the disorder in the particular device.

Our simulations also indicate large charging energies associated with each QD (17 meV) and large gate-coupling strengths (0.6 eV V^{-1} at $V_{tg} = 0$), which is attractive for high-temperature operation [63, 64], dispersive gate sensing with high SNRs [21, 38], and strong coupling to resonators or microwave cavities [36].

Experimentally, measurements of Coulomb diamonds as in figure 8(a) reveal charging energies of 15–20 meV for the first few electrons, and gate strengths of 0.4 – 0.5 eV V^{-1} , for all four QDs, consistent with simulations. The tunability of tunnel rates by the top gate can be observed by a change of DC current, I , when the device is biased as a serial double dot: figure 8(b) shows an increase in I when the same bias triangles are measured at $V_{tg} = 6$ V instead of $V_{tg} = 0$ V. The apparent shift of these bias triangles by 100–125 mV towards lower values of V_1 and V_4 is consistent with a capacitive coupling of the top gate to dot potentials measured independently. Alternatively, characteristic tunnel times for different top-gate voltages can be measured in time domain using high-bandwidth reflectometry, as recently reported in [21].

Appendix B. Details of the $\mathbf{k} \cdot \mathbf{p}$ modeling

The device used for $\mathbf{k} \cdot \mathbf{p}$ modeling comprises a silicon channel ($W = 70$ nm, $t_{Si} = 7$ nm, $L_{NW} = 165$ nm) with gate lengths $L_G = 32$ nm and gate spacings $S_V = S_H = 32$ nm, consistent with the measured device. The simulated gate stack consists of 6 nm of SiO_2 , 5 nm of TiN and 45 nm of poly-Si. The gate electrodes are capped by 25 nm of Si_3N_4 on each side, which mimic similar caps in the measured device that protect the channel during the ion implantation of source/drain dopants. The whole device is encapsulated in SiO_2 , with the 200 nm long top gate running 300 nm above the channel.

To capture electrostatic screening by the reservoirs, 20 nm raised source and drain contacts have been added to both ends of the channel. They are highly n -doped ($N_d = 10^{20}$ cm^{-3}). Along the channel, the density of donors decreases by one order of magnitude every 4 nm from the outer edges of the source/drain spacers. Therefore, the regions underneath the gates and underneath the central spacers are practically undoped. The poly-Si gate is also n -doped ($N_d = 2 \times 10^{19}$ cm^{-3}), while the silicon substrate below the 145 nm thick BOX layer is slightly p -doped ($N_a = 10^{15}$ cm^{-3}). We account for a 0.25 eV Schottky barrier at the interface between the poly-Si and TiN gates, inferred from the threshold voltage shifts measured at room temperature in similar devices with polysilicon-only gates. The dielectric constants of the materials are $\epsilon_{Si} = 11.7$, $\epsilon_{SiO_2} = 3.9$, and $\epsilon_{Si_3N_4} = 7.5$. TiN is modeled as a perfect metal.

Charge traps in amorphous materials such as Si_3N_4 can shift the average potential and introduce disorder in the barriers. In order to capture this potential shift, we have modeled these traps as a continuous distribution of charges at the SiO_2/Si_3N_4 interface. We observe that such majority carrier traps can significantly reduce the tunneling rates but have little impact on their tunability via the top gate. The results shown in figure 7 assume a charge density of -5×10^{11} $e \cdot cm^{-2}$ at the SiO_2/Si_3N_4 interface.

The potential in the device is computed self-consistently within the Thomas–Fermi approximation. For numerical convenience, we assume a temperature $T = 4.2$ K and account for incomplete ionization of the

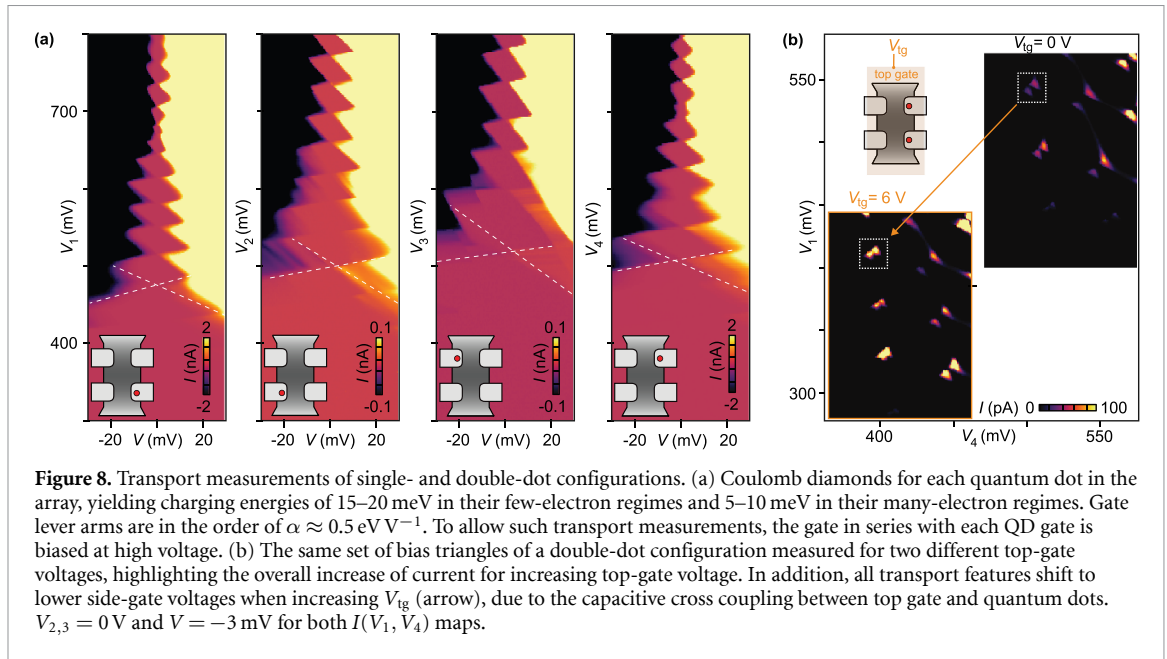
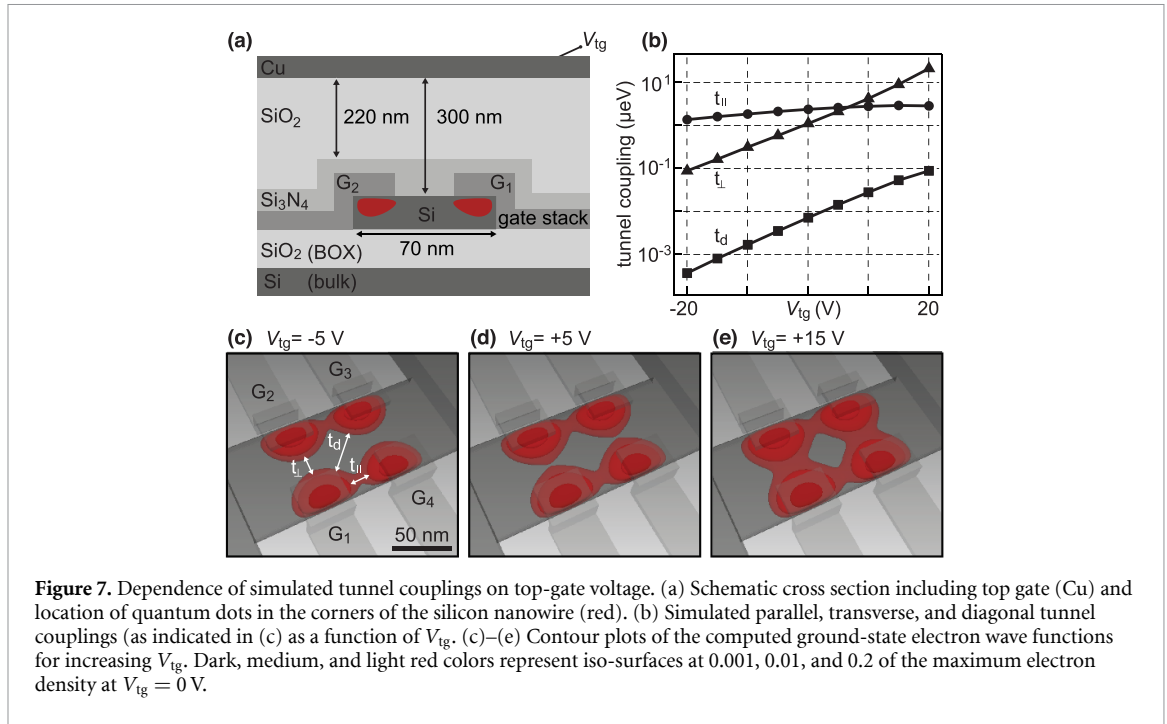

dopants at this temperature [65]. The one-particle states in the ground-state Z valley are calculated with a finite differences implementation of the anisotropic effective mass approximation [66].

We sweep the top-gate potential with the source, drain, and back-gate grounded. We apply the same voltage on all side gates G_1 – G_4 such that the ground-state energy of the four-dot system remains resonant with the chemical potential of the source and drain. We then map the energies and wave functions of the four lowest-lying states onto the following effective Hamiltonian:

$$H = \begin{bmatrix} E_{Q1} & t_{\perp} & t_d & t_{\parallel} \\ t_{\perp} & E_{Q2} & t_{\parallel} & t_d \\ t_d & t_{\parallel} & E_{Q3} & t_{\perp} \\ t_{\parallel} & t_d & t_{\perp} & E_{Q4} \end{bmatrix} \quad (1)$$

where E_{Qi} are the energies of the isolated QDs, t_{\parallel} is the tunnel coupling between neighboring QDs along the channel, t_{\perp} is the tunnel coupling between opposite face-to-face QDs, and t_d is the tunnel coupling between diagonal QDs. With the same voltage on gates G_1 – G_4 , the system remains at a degeneracy point where

$E_{Q_1} = E_{Q_2} = E_{Q_3} = E_{Q_4} = E_0$. The eigenenergies and parity (sign) of the wave functions in each dot are therefore:

$$E_1 = E_0 + t_{||} + t_{\perp} + t_d; \psi_1 = [+1, +1, +1, +1] \quad (2a)$$

$$E_2 = E_0 + t_{||} - t_{\perp} - t_d; \psi_2 = [+1, -1, -1, +1] \quad (2b)$$

$$E_3 = E_0 - t_{||} + t_{\perp} - t_d; \psi_3 = [+1, +1, -1, -1] \quad (2c)$$

$$E_4 = E_0 - t_{||} - t_{\perp} + t_d; \psi_4 = [+1, -1, +1, -1]. \quad (2d)$$

Once the calculated states have been unambiguously identified by their parities, $t_{||}$, t_{\perp} , and t_d can be fitted to their energies using the above equations.

Appendix C. Details of the constant-interaction capacitance model for the triple-dot configuration

To simulate figures 3(b) and (c) from the main text, we assume that the electrostatics of the triple-dot configuration can be described by a constant interaction model [43] that is represented in figure 3(a) as a circuit of 12 capacitors. For sufficiently small tunnel couplings, this approximation is expected to be sufficient to capture the ground-state geometry (in gate-voltage space) of a particular charge configuration. Since QD₂ was not activated in the experiment by setting V_2 to 0 V, we use in figure 3(a) a capacitance circuit that only involves QD₁, QD₃, and QD₄. (In reality, geometric capacitances associated with QD₂ and G₂ will contribute to some of these effective circuit capacitances.) To simulate the Coulomb valley of the 3058 configuration, we use the following capacitance matrix inferred from experimental stability diagrams:

$$C = \begin{bmatrix} 3.1 & - & 0.25 & 0.85 \\ - & - & - & - \\ 0.6 & - & 4.45 & 1.55 \\ 0.75 & - & 0.4 & 5.5 \end{bmatrix} \quad (3)$$

where diagonal elements C_{ii} correspond to the capacitive coupling between gate G_i and dot QD_i, and off-diagonal elements C_{ij} correspond to the capacitive coupling between gate G_j and dot QD_i. All capacitances are given in units of aF.

In addition, the following dot-to-dot capacitances were used for the simulations in figures 3(b) and (c): QD₁-to-QD₃ = 0.25 aF, QD₁-to-QD₄ = 1.25 aF, QD₃-to-QD₄ = 0.75 aF. As indicated in figure 3(a), the smallest capacitance in the circuit is the ‘diagonal’ capacitance between QD₁ and gate G₃ (0.25 aF), whereas the largest capacitance is the capacitance between QD₄ and gate G₄ (5.5 aF), consistent with its high occupation number.

Appendix D. Sensor operating points and compensation factors

The gate-voltage compensations used to produce the figures are as follows.

Figure 3(f) uses negative compensation:

$$V_4 [\text{V}] = 0.4455 - 0.28(V_1 - 0.26) - 0.115(V_3 - 0.455)$$

Figure 4(a) uses positive compensation:

$$V_4 [\text{V}] = 0.4 + 0.3(V_1 + V_2)$$

Figure 4(b) uses negative compensation:

$$V_4 [\text{V}] = 0.4455 - 0.28(V_1 - 0.1) - 0.115(V_2 - 0.18)$$

Figure 4(e)–(h) uses negative compensation:

$$V_4 [\text{V}] = V_4^o - 0.28(V_1 - 0.07) - 0.115(V_2 - 0.15)$$

with slightly different values V_4^o for each panel.

Appendix E. Signal-to-noise ratio of charge sensing

In figure 9(a), a stability diagram around the (1,1)-(2,0) transition of the double dot under G₂ and G₃ is shown, for a top-gate voltage of +30 V and with QD₁ kept empty. Fixing the DC gate voltages V_2 and V_3 at the interdot transition (marked with a black star), the application of a square detuning pulse (50/50 duty cycle with a 2 ms period and an amplitude marked by a red and blue star) to $V_2^F(t)$ and $V_3^F(t)$ results in the data shown in Suppl. Figure 9(b). Each row represents a single-shot trace associated with one pulse period.

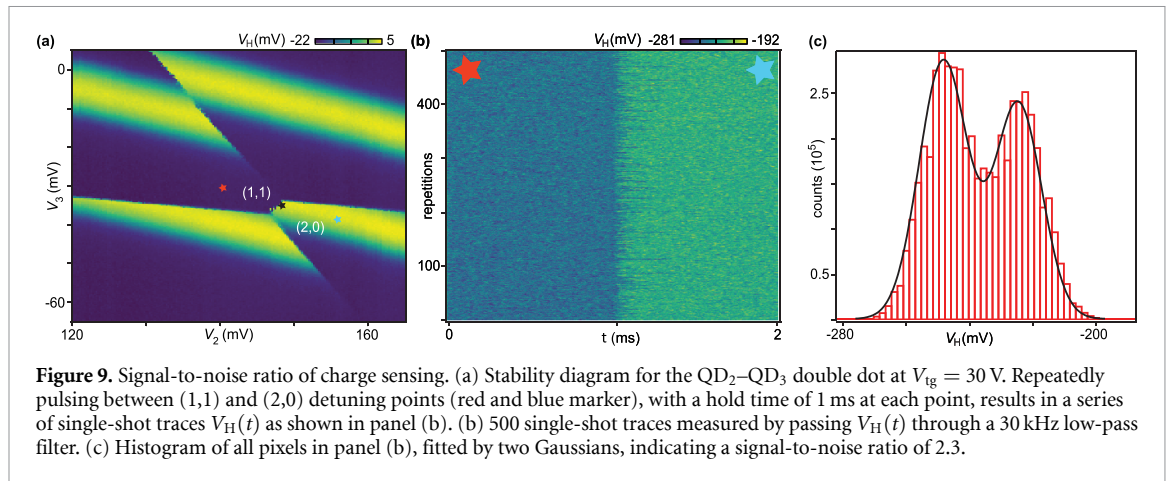

For these measurements, the effective bandwidth of 30 kHz is set by passing the demodulated reflectometry signal $V_{\text{H}}(t)$ through an analog low-pass filter (SRS model SR560) prior to digitization (AlazarTech ATS9360). Between acquiring panel (a) and (b), the gain of the SR560 and other settings in the reflectometry setup were adjusted, which explains the different ranges of V_{H} . By converting panel (b) to a histogram and fitting it with the sum of two Gaussian functions as shown in Suppl. Figure 9(c), we extract the SNR as the offset ΔV_{H} of the two Gaussians normalized by $\sqrt{\sigma_1^2 + \sigma_2^2}$, where σ_1 and σ_2 are standard deviations of the Gaussian functions. In this example, for a detection bandwidth of 30 kHz, the SNR is 2.3.

ORCID iDs

Federico Fedele <https://orcid.org/0000-0003-4466-5576>

Fabrizio Berritta <https://orcid.org/0000-0002-7452-9017>

Jing Li <https://orcid.org/0000-0002-9283-3821>

Ferdinand Kuemmeth <https://orcid.org/0000-0003-3675-7331>

References

- [1] Chatterjee A, Stevenson P, De Franceschi S, Morello A, de Leon N P and Kuemmeth F 2021 Semiconductor qubits in practice *Nat. Rev. Phys.* **3** 157–77
- [2] Madzik M T et al 2022 Precision tomography of a three-qubit donor quantum processor in silicon *Nature* **601** 348
- [3] Xue X, Russ M, Samkharadze N, Undseth B, Sammak A, Scappucci G and Vandersypen L M K 2022 Quantum logic with spin qubits crossing the surface code threshold *Nature* **601** 343
- [4] Noiri A, Takeda K, Nakajima T, Kobayashi T, Sammak A, Scappucci G and Tarucha S 2022 Fast universal quantum gate above the fault-tolerance threshold in silicon *Nature* **601** 338
- [5] Maurand R et al 2016 A CMOS silicon spin qubit *Nat. Commun.* **7** 1
- [6] Crippa A et al 2019 Gate-reflectometry dispersive readout and coherent control of a spin qubit in silicon *Nat. Commun.* **10** 2776
- [7] Li R et al 2020 A flexible 300 mm integrated Si MOS platform for electron- and hole-spin qubits exploration 2020 *IEEE Int. Electron Devices Meeting (IEDM)* pp 38.3.1–4
- [8] Zwerger A M J et al 2022 Qubits made by advanced semiconductor manufacturing *Nature Electronics* **5** 184
- [9] Pillarisetty R et al 2018 Qubit device integration using advanced semiconductor manufacturing process technology 2018 *IEEE Int. Electron Devices Meeting (IEDM)* pp 6.3.1–4
- [10] Dumoulin Stuyck N I et al 2021 Uniform spin qubit devices with tunable coupling in an all-silicon 300 mm integrated process 2021 *Symp. on VLSI Circuits* pp 1–2
- [11] De Franceschi S et al 2016 SOI technology for quantum information processing 2016 *IEEE Int. Electron Devices Meeting (IEDM)* pp 13.4.1–4
- [12] Vinet M et al 2018 Towards scalable silicon quantum computing 2018 *IEEE Int. Electron Devices Meeting (IEDM)* pp 6.5.1–4
- [13] Loss D and DiVincenzo D P 1998 Quantum computation with quantum dots *Phys. Rev. A* **57** 1
- [14] Fowler A G, Mariantoni M, Martinis J M and Cleland A N 2012 Surface codes: towards practical large-scale quantum computation *Phys. Rev. A* **86** 3
- [15] Thalieu R, Hermelin S, Wieck A D, Bäuerle C, Saminadayar L and Meunier T 2012 A few-electron quadruple quantum dot in a closed loop *Appl. Phys. Lett.* **101** 103102
- [16] Mortemousse P-A, Chanrion E, Jadot B, Flentje H, Ludwig A, Wieck A D, Urdampilleta M, Bäuerle C and Meunier T 2020 Coherent control of individual electron spins in a two-dimensional quantum dot array *Nat. Nanotechnol.* **16** 296–301
- [17] Mukhopadhyay U, Dehollain J P, Reichl C, Wegscheider W and Vandersypen L M K 2018 A 2×2 quantum dot array with controllable interdot tunnel couplings *Appl. Phys. Lett.* **112** 183505
- [18] Fedele F, Chatterjee A, Fallahi S, Gardner G C, Manfra M J and Kuemmeth F 2021 Simultaneous operations in a two-dimensional array of singlet-triplet qubits *PRX Quantum* **2** 040306
- [19] van Riggelen F, Hendrickx N W, Lawrie W I L, Russ M, Sammak A, Scappucci G and Veldhorst M 2021 A two-dimensional array of single-hole quantum dots *Appl. Phys. Lett.* **118** 044002

- [20] Boter J M *et al* 2022 Spiderweb array: a sparse spin-qubit array *Phys. Rev. Appl.* **18** 024053
- [21] Ansaloni F, Chatterjee A, Bohuslavskiy H, Bertrand B, Hutin L, Vinet M and Kuemmeth F 2020 Single-electron operations in a foundry-fabricated array of quantum dots *Nat. Commun.* **11** 6399
- [22] Leon R C C *et al* 2020 Coherent spin control of s-, p-, d- and f-electrons in a silicon quantum dot *Nat. Commun.* **11** 797
- [23] Lundberg T *et al* 2020 Spin quintet in a silicon double quantum dot: spin blockade and relaxation *Phys. Rev. X* **10** 4
- [24] Ciriano-Tejel V N *et al* 2021 Spin readout of a CMOS quantum dot by gate reflectometry and spin-dependent tunneling *PRX Quantum* **2** 010353
- [25] Oakes G A *et al* 2022 Fast high-fidelity single-shot readout of spins in silicon using a single-electron box *Phys. Rev. X* **13** 1
- [26] (Available at: www.qdevil.com)
- [27] Vigneau F, Fedele F, Chatterjee A, Reilly D, Kuemmeth F, Gonzalez-Zalba F, Laird E and Ares N 2022 Probing quantum devices with radio-frequency reflectometry (arXiv:2202.10516)
- [28] Barraud S, Lavieville R, Hutin L, Bohuslavskiy H, Vinet M, Corna A, Clapera P, Sanquer M and Jehl X 2016 Development of a CMOS route for electron pumps to be used in quantum metrology *Technologies* **4** 1
- [29] Hutin L, Maurand R, Kotekar-Patil D, Corna A, Bohuslavskiy H, Jehl X, Barraud S, De Franceschi S, Sanquer M and Vinet M 2016 Si CMOS platform for quantum information processing 2016 *IEEE Symp. on VLSI Technology* pp 1–2
- [30] Volk C, Chatterjee A, Ansaloni F, Marcus C M and Kuemmeth F 2019 Fast charge sensing of Si/SiGe quantum dots via a high-frequency accumulation gate *Nano Lett.* **19** 8
- [31] Roche B, Voisin B, Jehl X, Wacquez R, Sanquer M, Vinet M, Deshpande V and Previtali B 2012 Realization of both a single electron transistor and a field effect transistor with an underlapped FDSOI MOSFET geometry *Appl. Phys. Lett.* **100** 3
- [32] Chatterjee A, Ansaloni F, Rasmussen T, Brovang B, Fedele F, Bohuslavskiy H, Krause O and Kuemmeth F 2022 Autonomous estimation of high-dimensional coulomb diamonds from sparse measurements *Phys. Rev. Appl.* **18** 064040
- [33] Duan J, Fogarty M A, Williams J, Hutin L, Vinet M and Morton J J L 2020 Remote capacitive sensing in two-dimensional quantum-dot arrays *Nano Lett.* **20** 7123–8
- [34] Gilbert W *et al* 2020 Single-electron operation of a silicon-CMOS 2×2 quantum dot array with integrated charge sensing *Nano Lett.* **20** 7882–8
- [35] Ezzouch R *et al* 2021 Dispersively probed microwave spectroscopy of a silicon hole double quantum dot *Phys. Rev. Appl.* **16** 034031
- [36] Ibberson D J *et al* 2021 Large dispersive interaction between a cmos double quantum dot and microwave photons *PRX Quantum* **2** 020315
- [37] Gonzalez-Zalba M F, Barraud S, Ferguson A J and Betz A C 2015 Probing the limits of gate-based charge sensing *Nat. Commun.* **6** 1
- [38] Chanrion E *et al* 2020 Charge detection in an array of CMOS quantum dots *Phys. Rev. Appl.* **14** 024066
- [39] Martinez B and Niquet Y-M 2022 Variability of electron and hole spin qubits due to interface roughness and charge traps *Phys. Rev. Appl.* **17** 024022
- [40] Volk C *et al* 2019b Loading a quantum-dot based ‘Qubyte’ register *npj Quantum Inf.* **5** 29
- [41] Mills A R, Zajac D M, Gullans M J, Schupp F J, Hazard T M and Petta J R 2019 Shuttling a single charge across a one-dimensional array of silicon quantum dots *Nat. Commun.* **10** 1063
- [42] Medford J, Beil J, Taylor J M, Bartlett S D, Doherty A C, Rashba E I, Divincenzo D P, Lu H, Gossard A C and Marcus C M 2013 Self-consistent measurement and state tomography of an exchange-only spin qubit *Nat. Nanotechnol.* **8** 654–9
- [43] van der Wiel W G, De Franceschi S, Elzerman J M, Fujisawa T, Tarucha S and Kouwenhoven L P 2002 Electron transport through double quantum dots *Rev. Mod. Phys.* **75** 1–22
- [44] It is for this illustrative reason that we show measurements for the 3058 charge state. For the 1018 state, the dispersive signals arising from charge transitions of QD₁ and QD₃ are too small to be visible.
- [45] Gaudreau L, Studenikin S A, Sachrajda A S, Zawadzki P, Kam A, Lapointe J, Korkusiński M and Hawrylak P 2006 Stability diagram of a few-electron triple dot *Phys. Rev. Lett.* **97** 3
- [46] Hamo A, Benyamini A, Shapir I, Khivrich I, Waissman J, Kaasbjerg K, Oreg Y, von Oppen F and Ilani S 2016 Electron attraction mediated by coulomb repulsion *Nature* **535** 395–400
- [47] Higginbotham A P, Kuemmeth F, Hanson M P, Gossard A C and Marcus C M 2014 Coherent operations and screening in multielectron spin qubits *Phys. Rev. Lett.* **112** 026801
- [48] $V_2 = 0.88\varepsilon + V_2^0$, $V_3 = -0.47\varepsilon + V_3^0$, with (V_2^0, V_3^0) centered at the inderdot transition.
- [49] Chen E H *et al* 2021 Detuning axis pulsed spectroscopy of valley-orbital states in Si/Si-Ge quantum dots *Phys. Rev. Appl.* **15** 044033
- [50] Jones A M *et al* 2019 Spin-blockade spectroscopy of Si/Si-Ge quantum dots *Phys. Rev. Appl.* **12** 014026
- [51] Borjans F, Mi X and Petta J R 2021 Spin digitizer for high-fidelity readout of a cavity-coupled silicon triple quantum dot *Phys. Rev. Appl.* **15** 044052
- [52] Culcer D, Hu X and Das Sarma S 2010 Interface roughness, valley-orbit coupling and valley manipulation in quantum dots *Phys. Rev. B* **82** 205315
- [53] Corna A *et al* 2018 Electrically driven electron spin resonance mediated by spin-valley-orbit coupling in a silicon quantum dot *npj Quantum Inf.* **4** 6
- [54] Abadillo-Uriel J C, Martinez B, Filippone M and Niquet Y-M 2021 Two-body Wigner molecularization in asymmetric quantum dot spin qubits *Phys. Rev. B* **104** 195305
- [55] Ekmel Ercan H, Coppersmith S N and Friesen M 2021 Strong electron-electron interactions in Si/SiGe quantum dots *Phys. Rev. B* **104** 235302
- [56] Pecker S, Kuemmeth F, Secchi A, Rontani M, Ralph D C, McEuen P L and Ilani S 2013 Observation and spectroscopy of a two-electron Wigner molecule in an ultraclean carbon nanotube *Nat. Phys.* **9** 576–81
- [57] Petersson K D, Smith C G, Anderson D, Atkinson P, Jones G A C and Ritchie D A 2010 Charge and spin state readout of a double quantum dot coupled to a resonator *Nano Lett.* **10** 2789–93
- [58] Stehlik J, Liu Y, Quintana C M, Eichler C, Hartke T R and Petta J R 2015 Fast charge sensing of a cavity-coupled double quantum dot using a Josephson parametric amplifier *Phys. Rev. Appl.* **4** 014018
- [59] Schaal S *et al* 2020 Fast gate-based readout of silicon quantum dots using Josephson parametric amplification *Phys. Rev. Lett.* **124** 6
- [60] Noiri A, Takeda K, Yoneda J, Nakajima T, Kodera T and Tarucha S 2020 Radio-frequency-detected fast charge sensing in undoped silicon quantum dots *Nano Lett.* **20** 2
- [61] Clapera P, Ray S, Jehl X, Sanquer M, Valentian A and Barraud S 2015 Design and cryogenic operation of a hybrid quantum-CMOS circuit *Phys. Rev. Appl.* **4** 4
- [62] Schaal S, Rossi A, Ciriano-Tejel V N, Yang T-Y, Barraud S, Morton J J L and Gonzalez-Zalba M F 2019 A CMOS dynamic random access architecture for radio-frequency readout of quantum devices *Nat. Electron.* **2** 236–42

- [63] Yang C H *et al* 2020 Universal quantum logic in hot silicon qubits *Nature* **580** 350
- [64] Petit L, Eenink H G J, Russ M, Lawrie W I L, Hendrickx N W, Philips S G J, Clarke J S, Vandersypen L M K and Veldhorst M 2020 Universal quantum logic in hot silicon qubits *Nature* **580** 355–9
- [65] Altermatt P P, Schenk A, Schmithÿsen B and Heiser G 2006 A simulation model for the density of states and for incomplete ionization in crystalline silicon. I. Establishing the model in Si:P *J. Appl. Phys.* **100** 11
- [66] Venitucci B, Li J, Bourdet L and Niquet Y 2019 Modeling silicon CMOS devices for quantum computing 2019 *Int. Conf. on Simulation of Semiconductor Processes and Devices (SISPAD)* pp 1–4