



HAL
open science

Spectrum of the Laplacian with mixed boundary conditions in a chamfered quarter of layer

Lucas Chesnel, Sergei A. Nazarov, Jari Taskinen

► **To cite this version:**

Lucas Chesnel, Sergei A. Nazarov, Jari Taskinen. Spectrum of the Laplacian with mixed boundary conditions in a chamfered quarter of layer. *Journal of Spectral Theory*, In press. hal-04048228v2

HAL Id: hal-04048228

<https://hal.science/hal-04048228v2>

Submitted on 11 Apr 2024

HAL is a multi-disciplinary open access archive for the deposit and dissemination of scientific research documents, whether they are published or not. The documents may come from teaching and research institutions in France or abroad, or from public or private research centers.

L'archive ouverte pluridisciplinaire **HAL**, est destinée au dépôt et à la diffusion de documents scientifiques de niveau recherche, publiés ou non, émanant des établissements d'enseignement et de recherche français ou étrangers, des laboratoires publics ou privés.

Spectrum of the Laplacian with mixed boundary conditions in a chamfered quarter of layer

LUCAS CHESNEL¹, SERGEI A. NAZAROV², JARI TASKINEN³

¹ IDEFIX, Ensta Paris, Institut Polytechnique de Paris, 828 Boulevard des Maréchaux, 91762 Palaiseau, France;

² Institute of Problems of Mechanical Engineering RAS, V.O., Bolshoi pr., 61, St. Petersburg, 199178, Russia;

³ Department of Mathematics and Statistics, University of Helsinki, P.O.Box 68, FI-00014 Helsinki, Finland.

E-mails: lucas.chesnel@inria.fr, srgnazarov@yahoo.co.uk, jari.taskinen@helsinki.fi.

(April 11, 2024)

Abstract. We investigate the spectrum of a Laplace operator with mixed boundary conditions in an unbounded chamfered quarter of layer. This problem arises in the study of the spectrum of the Dirichlet Laplacian in thick polyhedral domains having some symmetries such as the so-called Fichera layer. The geometry we consider depends on two parameters gathered in some vector $\kappa = (\kappa_1, \kappa_2)$ which characterizes the domain at the edges. By exchanging the axes and/or modifying their orientations if necessary, it is sufficient to restrict the analysis to the cases $\kappa_1 \geq 0$ and $\kappa_2 \in [-\kappa_1, \kappa_1]$. We identify the essential spectrum and establish different results concerning the discrete spectrum with respect to κ . In particular, we show that for a given $\kappa_1 > 0$, there is some $h(\kappa_1) > 0$ such that discrete spectrum exists for $\kappa_2 \in [-\kappa_1, 0) \cup (h(\kappa_1), \kappa_1]$ whereas it is empty for $\kappa_2 \in [0, h(\kappa_1)]$. The proofs rely on classical arguments of spectral theory such as the max-min principle. The main originality lies rather in the delicate use of the features of the geometry.

Key words. Laplacian with mixed boundary conditions, chamfered quarter of layer, Fichera layer, discrete spectrum, trapped modes.

Mathematics Subject Classification. 35J05, 35P15, 35Q40, 81Q10, 65N25

1 Formulation of the problem

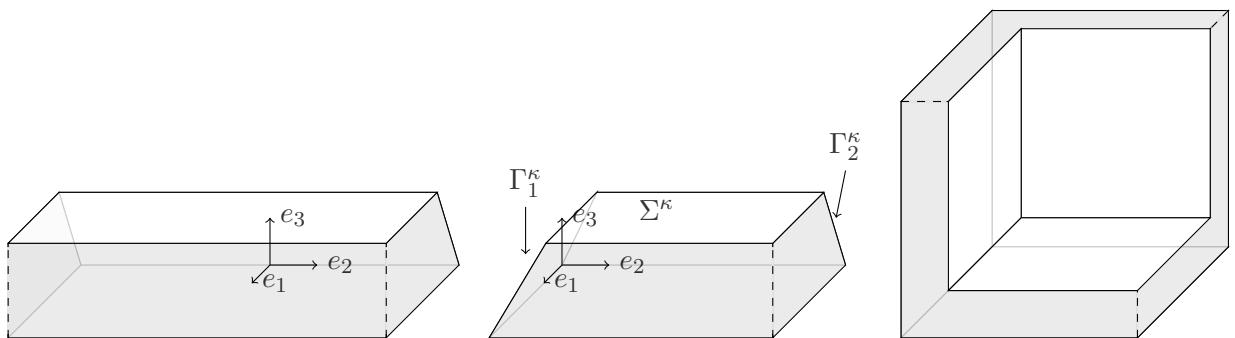

Figure 1: Domains \mathcal{B}^{κ_1} (left) and Ω^κ (centre). Fichera layer \mathcal{F} (right).

The original motivation for this work comes from the study of the spectrum of the Laplace operator with Dirichlet boundary conditions in thick polyhedral domains having some symmetries. The archetype of such geometries is the so-called Fichera layer

$$\mathcal{F} := \bigcup_{j=1,2,3} \{x = (x_1, x_2, x_3) \in \mathbb{R}^3 \mid x_j \in (0, 1), x_k > 0, k \neq j\} \quad (1)$$

represented in Figure 1 right (see [10] for the original article that gave rise to the name). Exploiting symmetries, in certain cases one can reduce the analysis to the one of the spectrum of the Laplace operator with mixed boundary conditions in chamfered quarters of layers. More precisely, the geometries that we consider in this article are characterized by two parameters $\kappa_1, \kappa_2 \in \mathbb{R}$ that we gather in some vector $\kappa = (\kappa_1, \kappa_2)$. Referring to carpentry and locksmith tools, we first define the “blade”

$$\mathcal{B}^{\kappa_1} := \{x \mid x_1 > \kappa_1 x_3, x_2 \in \mathbb{R}, x_3 \in (0, 1)\} \quad (2)$$

(see Figure 1 left). Then we introduce the “incisor”

$$\Omega^\kappa := \{x \in \mathcal{B}^{\kappa_1} \mid x_2 > \kappa_2 x_3\} \quad (3)$$

(see Figure 1 centre). Let us give names to the different components of the boundary $\partial\Omega^\kappa$ of Ω^κ . First, denote by Σ^κ the union of the two “horizontal” quadrants:

$$\Sigma^\kappa := \{x \in \partial\Omega^\kappa \mid x_3 = 0 \text{ or } x_3 = 1\}.$$

Then consider the laterals sides of the incisor. Set

$$\Gamma_1^\kappa := \partial\Omega^\kappa \cap \mathcal{B}^{\kappa_1}, \quad \Gamma_2^\kappa := \partial\Omega^\kappa \setminus \{\overline{\Gamma_1^\kappa} \cup \overline{\Sigma^\kappa}\}. \quad (4)$$

We study the spectral problem with mixed boundary conditions

$$\begin{cases} -\Delta_x u = \lambda u & \text{in } \Omega^\kappa \\ u = 0 & \text{on } \Sigma^\kappa \\ \partial_\nu u = 0 & \text{on } \Gamma_1^\kappa \cup \Gamma_2^\kappa, \end{cases} \quad (5)$$

where ∂_ν is the outward normal derivative on $\partial\Omega^\kappa$. Observe that by exchanging the axes and/or modifying their orientations, there is no loss of generality to restrict the analysis to the cases

$$\kappa_1 \geq 0, \quad |\kappa_2| \leq \kappa_1.$$

Denote by $H_0^1(\Omega^\kappa; \Sigma^\kappa)$ the Sobolev space of functions of $H^1(\Omega^\kappa)$ vanishing on Σ^κ . Classically (see e.g. [14, 15]), the variational formulation of Problem (5) writes

$$\begin{cases} \text{Find } (\lambda, u) \in \mathbb{R} \times H_0^1(\Omega^\kappa; \Sigma^\kappa) \setminus \{0\} \text{ such that} \\ (\nabla_x u, \nabla_x \psi)_{\Omega^\kappa} = \lambda (u, \psi)_{\Omega^\kappa} \quad \forall \psi \in H_0^1(\Omega^\kappa; \Sigma^\kappa), \end{cases} \quad (6)$$

where for a domain Ξ , $(\cdot, \cdot)_\Xi$ stands for the inner product of the Lebesgue spaces $L^2(\Xi)$ or $(L^2(\Xi))^3$ according to the case. Integrating first with respect to the x_3 variable and using the homogeneous Dirichlet condition on Σ^κ for the functions in $H_0^1(\Omega^\kappa; \Sigma^\kappa)$, one can prove that there holds the Friedrichs inequality

$$\|u; L^2(\Omega^\kappa)\|^2 \leq c_\kappa \|\nabla_x u; L^2(\Omega^\kappa)\|^2 \quad \forall u \in H_0^1(\Omega^\kappa; \Sigma^\kappa),$$

where $c_\kappa > 0$ is a constant which depends only on κ . As known e.g. from [4, §10.1] or [20, Ch. VIII.6], the variational problem (6) gives rise to the unbounded operator A^κ of $L^2(\Omega^\kappa)$ such that

$$\begin{aligned} A^\kappa : \mathcal{D}(A^\kappa) &\rightarrow L^2(\Omega^\kappa) \\ u &\mapsto A^\kappa u = -\Delta u, \end{aligned}$$

with $\mathcal{D}(A^\kappa) := \{u \in H_0^1(\Omega^\kappa; \Sigma^\kappa) \mid \Delta u \in L^2(\Omega^\kappa) \text{ and } \partial_\nu u = 0 \text{ on } \Gamma_1^\kappa \cup \Gamma_2^\kappa\}$. The operator A^κ is positive definite and selfadjoint. Since Ω^κ is unbounded, the embedding $H_0^1(\Omega^\kappa; \Sigma^\kappa) \subset L^2(\Omega^\kappa)$ is not compact and A^κ has a non-empty essential component $\sigma_{\text{ess}}(A^\kappa)$ ([4, Thm. 10.1.5]). Note that the case

$$\kappa_1 = \kappa_2 = 1$$

plays a particular role. Indeed in this situation, if u is an eigenfunction associated with an eigenvalue of A^κ , by extending u via even reflections with respect to the faces $\Gamma_1^\kappa, \Gamma_2^\kappa$, one gets an eigenvalue of the Dirichlet Laplacian in the Fichera layer \mathcal{F} defined in (1). This latter problem has been studied in [6, 2]. More precisely, in [6] the authors give a characterization of the essential spectrum of the Dirichlet Laplacian and show that the discrete spectrum has at most a finite number of eigenvalues. The existence of discrete spectrum is proved in [2, Thm. 2].

The goal of this paper is to get similar information for the operator A^κ with respect to the parameter κ . In the present work, we will also show that the spectrum of the Dirichlet Laplacian in Ω^κ , i.e. with homogeneous Dirichlet boundary conditions everywhere on $\partial\Omega^\kappa$, has a rather simple structure with only essential spectrum and no discrete spectrum.

This note is organized as follows. In Section 2, we describe the essential spectrum of A^κ (Theorem 2.1). Then in Section 3, we state the results for the discrete spectrum of A^κ (the main outcome of the present work is Theorem 3.2). The next four sections contain the proof of the different items of Theorem 3.2. In Section 8, we illustrate the theory with some numerical results. Finally we establish the above mentioned result related to the Dirichlet Laplacian in Ω^κ in the Appendix (Proposition 8.1).

2 Essential spectrum

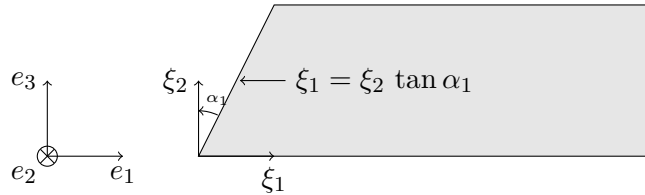

Figure 2: Domain Π^{α_1} corresponding with a cut of the blade \mathcal{B}^{κ_1} in the plane $x_2 = 0$.

Introducing the angle $\alpha_1 \in [0, \pi/2)$ such that $\kappa_1 = \tan \alpha_1$, the blade (2) can also be defined as

$$\mathcal{B}^{\tan \alpha_1} = \{(x_1, x_2, x_3) \in \mathbb{R}^3 \mid (x_1, x_3) \in \Pi^{\alpha_1}\}$$

where Π^{α_1} stands for the 2D pointed strip

$$\Pi^{\alpha_1} := \{\xi = (\xi_1, \xi_2) \in \mathbb{R}^2 \mid \xi_1 > \xi_2 \tan \alpha_1, \xi_2 \in (0, 1)\} \quad (7)$$

(see Figure 2). To describe $\sigma_{\text{ess}}(A^\kappa)$, we need information on the spectrum of the auxiliary planar problem

$$\begin{cases} -\Delta_\xi v = \mu v & \text{in } \Pi^{\alpha_1} \\ v = 0 & \text{on } \zeta^{\alpha_1} \\ \partial_\nu v = 0 & \text{on } \gamma^{\alpha_1} \end{cases} \quad (8)$$

where $\zeta^{\alpha_1} := \{\xi \in \partial\Pi^{\alpha_1} \mid \xi_2 = 0 \text{ or } \xi_2 = 1\}$ denotes the horizontal part of $\partial\Pi^{\alpha_1}$ and $\gamma^{\alpha_1} := \partial\Pi^{\alpha_1} \setminus \overline{\zeta^{\alpha_1}}$ stands for the oblique part of $\partial\Pi^{\alpha_1}$.

The continuous spectrum of Problem (8) coincides with the ray $[\pi^2, +\infty)$. When $\alpha_1 = 0$ (straight end), working with the decomposition in Fourier series in the vertical direction, one can prove that the discrete spectrum is empty. On the other hand, for all $\alpha_1 \in (0, \pi/2)$, it has been shown in [12] that there is at least one eigenvalue below the continuous spectrum (see also [17] for more general shapes). Notice that by extending Π^{α_1} by reflection with respect to γ^{α_1} , we obtain a broken strip that we can also call a V-shaped domain. This allows us to exploit all the results from [9, 19] (see

also [8] as well as the amendments in [18]) to get information on $\mu_1^{\alpha_1}$, the smallest eigenvalue of (8). In particular, the function $\alpha_1 \mapsto \mu_1^{\alpha_1}$ is smooth and strictly decreasing on $(0, \pi/2)$. Additionally, we have

$$\lim_{\alpha_1 \rightarrow 0^+} \mu_1^{\alpha_1} = \pi^2, \quad \lim_{\alpha_1 \rightarrow (\pi/2)^-} \mu_1^{\alpha_1} = \frac{\pi^2}{4} \quad (9)$$

(see Figure 8 for a numerical approximation of $\alpha_1 \mapsto \mu_1^{\alpha_1}$). By adapting the approach proposed in [6, §3.1], one establishes the next assertion. The only point to be commented here is that there holds

$$\lambda_{\dagger}^{\kappa} := \mu_1^{\arctan \kappa_1} \leq \mu_1^{\arctan |\kappa_2|} \quad (10)$$

because $|\kappa_2| \leq \kappa_1$ implies $\arctan |\kappa_2| \leq \arctan \kappa_1$ and because $\alpha_1 \mapsto \mu_1^{\alpha_1}$ is decreasing.

Theorem 2.1. *The essential spectrum $\sigma_{\text{ess}}(A^{\kappa})$ of the operator A^{κ} coincides with the ray $[\lambda_{\dagger}^{\kappa}, +\infty)$ where $\lambda_{\dagger}^{\kappa}$ is defined in (10).*

Remark 2.2. *Thus the lower bound of $\sigma_{\text{ess}}(A^{\kappa})$ is characterized by the sharpest edge of Ω^{κ} .*

3 Discrete spectrum

For the discrete spectrum $\sigma_{\text{d}}(A^{\kappa})$, our main results are as follows:

Theorem 3.1. *For $\kappa_1 = \kappa_2 = 0$ (straight edges), $\sigma_{\text{d}}(A^{\kappa})$ is empty.*

Theorem 3.2. *Assume that $\kappa_1 > 0$.*

1) $\sigma_{\text{d}}(A^{\kappa})$ is non-empty for $\kappa_2 \in [-\kappa_1, 0)$.

2) There exists $h(\kappa_1) \in (0, \kappa_1)$ such that:

i) $\sigma_{\text{d}}(A^{\kappa})$ is empty for $\kappa_2 \in [0, h(\kappa_1)]$;

ii) $\sigma_{\text{d}}(A^{\kappa})$ is non-empty for $\kappa_2 \in (h(\kappa_1), \kappa_1]$.

3) For $\kappa_2 \in [-\kappa_1, 0) \cup (h(\kappa_1), \kappa_1]$, denote by λ_1^{κ} the first (smallest) eigenvalue of $\sigma_{\text{d}}(A^{\kappa})$.

The function $\kappa_2 \mapsto \lambda_1^{\kappa}$ is strictly increasing on $[-\kappa_1, 0)$ and strictly decreasing on $(h(\kappa_1), \kappa_1]$.

4) For $\kappa_2 \in (-\kappa_1, \kappa_1)$, $\sigma_{\text{d}}(A^{\kappa})$ contains at most a finite number of eigenvalues.

The items 1)-3) of Theorem 3.2 are illustrated by Figure 3. Note in particular that we have the following mechanism for positive κ_2 : diminishing κ_2 from the value κ_1 makes the eigenvalue λ_1^{κ} to reach the threshold $\lambda_{\dagger}^{\kappa} = \mu_1^{\arctan \kappa_1}$ at a certain $\kappa_2 = h(\kappa_1) \in (0, \kappa_1)$. Theorem 3.1 can be established quite straightforwardly by working with symmetries. The rest of the present note is dedicated to the proof of the statements of Theorem 3.2.

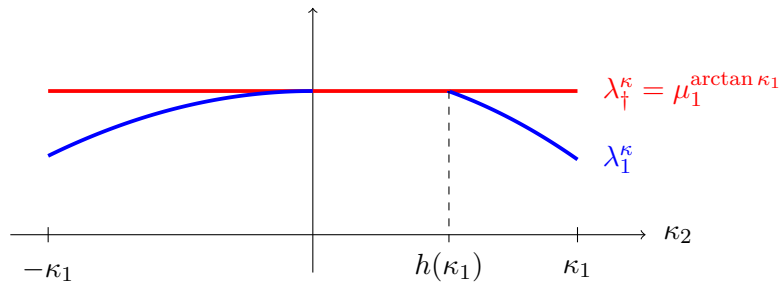

Figure 3: Schematic picture of the behaviour of λ_1^{κ} , the smallest eigenvalue of $\sigma_{\text{d}}(A^{\kappa})$, for a given $\kappa_1 > 0$ and $\kappa_2 \in [-\kappa_1, 0) \cup (h(\kappa_1), \kappa_1]$.

4 Discrete spectrum for negative κ_2

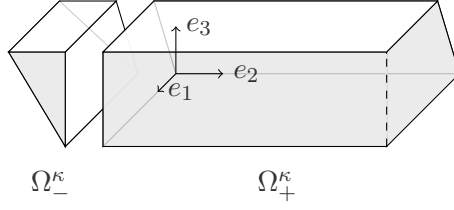

Figure 4: Domains Ω_-^κ and Ω_+^κ .

In this section, we prove the item 1) of Theorem 3.2 and so we consider the case $\kappa_2 < 0$. A direct application of the minimum principle, see e.g. [4, Thm. 10.2.1], [20, Thm. XIII.3], shows that the discrete spectrum of A^κ contains an eigenvalue λ_1^κ if one can find a trial function $\psi \in H_0^1(\Omega^\kappa; \Sigma^\kappa)$ such that

$$\|\nabla_x \psi; L^2(\Omega^\kappa)\|^2 < \lambda_1^\kappa \|\psi; L^2(\Omega^\kappa)\|^2. \quad (11)$$

Let us construct a function satisfying (11). To proceed, first divide the incisor Ω^κ into the two domains

$$\Omega_-^\kappa := \{x \in \Omega^\kappa \mid x_2 < 0\}, \quad \Omega_+^\kappa := \{x \in \Omega^\kappa \mid x_2 > 0\} = \Omega^{(\kappa_1, 0)} \quad (12)$$

(see Figure 4). Then for $\varepsilon > 0$ small, define ψ^ε such that

$$\psi^\varepsilon(x) = \begin{cases} v(x_1, x_3) & \text{in } \Omega_-^\kappa \\ e^{-\varepsilon x_2} v(x_1, x_3) & \text{in } \Omega_+^\kappa \end{cases} \quad (13)$$

where v is an eigenfunction of the 2D problem (8) associated with $\mu_1^{\alpha_1}$, the smallest eigenvalue, and $\alpha_1 = \arctan \kappa_1$. To set ideas, we choose v such that $\|v; L^2(\Pi^{\alpha_1})\| = 1$. Note that ψ^ε satisfies the homogeneous Dirichlet condition on Σ^κ and decays exponentially at infinity. Using (10), we obtain

$$\begin{aligned} & \|\nabla_x \psi^\varepsilon; L^2(\Omega_+^\kappa)\|^2 - \lambda_1^\kappa \|\psi^\varepsilon; L^2(\Omega_+^\kappa)\|^2 \\ &= (\|\nabla_\xi v; L^2(\Pi^{\alpha_1})\|^2 + (\varepsilon^2 - \mu_1^{\alpha_1}) \|v; L^2(\Pi^{\alpha_1})\|^2) \int_0^\infty e^{-2\varepsilon x_2} dx_2 = \frac{\varepsilon}{2}. \end{aligned} \quad (14)$$

As for the integral over the prism Ω_-^κ with triangular cross-sections and the bevelled end, we integrate by parts and take into account the boundary conditions of (5), which yields

$$\begin{aligned} \|\nabla_x \psi^\varepsilon; L^2(\Omega_-^\kappa)\|^2 - \lambda_1^\kappa \|\psi^\varepsilon; L^2(\Omega_-^\kappa)\|^2 &= - \int_{\Omega_-^\kappa} v(x_1, x_3) (\Delta_x v(x_1, x_3) + \mu_1^{\alpha_1} v(x_1, x_3)) dx \\ &\quad + \int_{\Gamma_1^\kappa} v(x_1, x_3) \partial_\nu v(x_1, x_3) ds =: I_{\Omega_-^\kappa} + I_{\Gamma_1^\kappa}. \end{aligned} \quad (15)$$

Owing to (8), there holds $I_{\Omega_-^\kappa} = 0$. Now we focus our attention on the term $I_{\Gamma_1^\kappa}$. Let (e_1, e_2, e_3) denote the canonical basis of \mathbb{R}^3 . Set $\alpha_2 := \arctan \kappa_2 \in (-\pi/2, 0)$ and define the new orthonormal basis $(\tilde{e}_1, \tilde{e}_2, \tilde{e}_3)$ with

$$\tilde{e}_1 = e_1; \quad \tilde{e}_2 = \cos(\alpha_2) e_2 - \sin(\alpha_2) e_3; \quad \tilde{e}_3 = \sin(\alpha_2) e_2 + \cos(\alpha_2) e_3. \quad (16)$$

Observe that the component Γ_1^κ of the boundary of the incisor Ω^κ is included in the plane $(O, \tilde{e}_1, \tilde{e}_3)$. Let $(\tilde{x}_1, \tilde{x}_2, \tilde{x}_3)$ denote the coordinates in the basis (16). We have

$$I_{\Gamma_1^\kappa} = -\frac{1}{2} \int_{\Gamma_1^\kappa} \frac{\partial(v^2)}{\partial \tilde{x}_2} d\tilde{x}_1 d\tilde{x}_3. \quad (17)$$

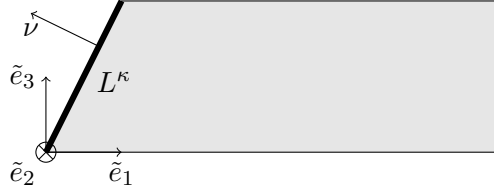

Figure 5: Domain Γ_1^κ in the plane $(O, \tilde{e}_1, \tilde{e}_3)$.

Using that v is independent of x_2 , we obtain

$$0 = \frac{\partial(v^2)}{\partial x_2} = \cos \alpha_2 \frac{\partial(v^2)}{\partial \tilde{x}_2} + \sin \alpha_2 \frac{\partial(v^2)}{\partial \tilde{x}_3}. \quad (18)$$

Combining (18) and (17), we find

$$I_{\Gamma_1^\kappa} = \frac{\tan \alpha_2}{2} \int_{\Gamma_1^\kappa} \frac{\partial(v^2)}{\partial \tilde{x}_3} d\tilde{x}_1 d\tilde{x}_3 = \frac{\tan \alpha_2}{2} \int_{\partial \Gamma_1^\kappa} v^2 \nu \cdot \tilde{e}_3 dl = \frac{\tan \alpha_2}{2} \int_{L^\kappa} v^2 \nu \cdot \tilde{e}_3 dl, \quad (19)$$

where $L^\kappa := \{x \in \mathbb{R}^3 \mid x_j = \kappa_j x_3, j = 1, 2, x_3 \in (0, 1)\}$ and where ν stands for the outward unit normal vector to $\partial \Gamma_1^\kappa$ (in the plane $(O, \tilde{e}_1, \tilde{e}_3)$). Using that $\alpha_2 \in (-\pi/2, 0)$, $\nu \cdot \tilde{e}_3 > 0$ on L^κ (see Figure 5) and $v \neq 0$ on L^κ , we deduce that $I_{\Gamma_1^\kappa} < 0$. Note also that the quantity $I_{\Gamma_1^\kappa}$ is independent of ε . Gathering (14) and (15), we infer that the inequality (11) holds for $\varepsilon > 0$ small enough. This is enough to guarantee that $\sigma_d(A^\kappa)$ is non-empty for negative κ_2 .

5 Absence of eigenvalues for small positive κ_2

The goal of this section is to prove an intermediate result to establish the item 2) of Theorem 3.2. Therefore we assume that $\kappa_2 \geq 0$. In that situation, the integral $I_{\Gamma_1^\kappa}$ in (19) is positive because $\alpha_2 \in [0, \pi/2)$ and our argument of the previous section does not work for showing the existence of discrete spectrum. Of course, this does not yet guarantee that $\sigma_d(A^\kappa)$ is empty. Actually we will see in Section 6 that $\sigma_d(A^\kappa)$ is non-empty for certain κ with $\kappa_2 > 0$. For the moment, combining the calculations of Section 4 with the approach of [16], we show the following result.

Proposition 5.1. *For all $\kappa_1 > 0$, there exists $\delta(\kappa_1) > 0$ such that $\sigma_d(A^\kappa)$ is empty for*

$$\kappa_2 \in [0, \delta(\kappa_1)). \quad (20)$$

Proof.

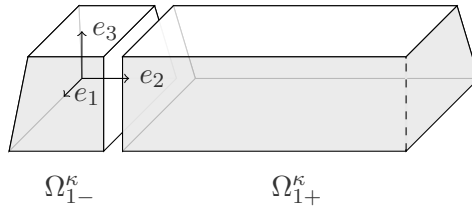

Figure 6: Domains Ω_{1-}^κ and Ω_{1+}^κ .

Fix $\kappa_2 \in [0, \min(1, \kappa_1))$ and divide Ω^κ into the two domains

$$\Omega_{1-}^\kappa := \{x \in \Omega^\kappa \mid x_2 < 1\} \quad \text{and} \quad \Omega_{1+}^\kappa := \{x \in \Omega^\kappa \mid x_2 > 1\} \quad (21)$$

(see Figure 6). Since $\Omega_{1+}^\kappa = \{(x_1, x_2, x_3) \in \mathbb{R}^3 \mid (x_1, x_3) \in \Pi^{\arctan \kappa_1}, x_2 > 1\}$, there holds

$$\|\nabla_x \psi; L^2(\Omega_{1+}^\kappa)\|^2 \geq \lambda_1^\kappa \|\psi; L^2(\Omega_{1+}^\kappa)\|^2 \quad (22)$$

for all $\psi \in H_0^1(\Omega^\kappa; \Sigma^\kappa)$. Below we show that there is some $\varrho > 0$ such that for κ_2 small enough, there holds, for all $\psi \in H_0^1(\Omega^\kappa; \Sigma^\kappa)$,

$$\|\nabla_x \psi; L^2(\Omega_{1-}^\kappa)\|^2 \geq (\lambda_+^\kappa + \kappa_2 \varrho) \|\psi; L^2(\Omega_{1-}^\kappa)\|^2. \quad (23)$$

Combining (22) and (23) with the minimum principle yields the result of the proposition.

Remark 5.2. Note that estimate (22) implies that $\sigma_d(A^\kappa)$ is empty for all $\kappa = (\kappa_1, 0)$ with $\kappa_1 \geq 0$. In the remaining part of the proof, we establish (23). Consider the mixed boundary-value problem

$$\begin{cases} -\Delta_x w = \tau w & \text{in } \Omega_{1-}^\kappa \\ w = 0 & \text{on } \{x \in \partial\Omega_{1-}^\kappa \mid x_3 = 0 \text{ or } x_3 = 1\} \\ \partial_\nu w = 0 & \text{on } \{x \in \partial\Omega_{1-}^\kappa \mid x_3 \in (0, 1)\}. \end{cases} \quad (24)$$

As pictured in Figure 6 left, the domain Ω_{1-}^κ in (21) is a semi-infinite prism with a trapezoidal cross-section and a skewed end. When $\kappa_2 = 0$, the trapezoid is simply the unit square and the continuous spectrum of the problem (24) coincides with the ray $[\pi^2, +\infty)$. In that situation, the problem (24) admits an eigenvalue at $\mu_1^{\alpha_1} \in (0, \pi^2)$ with $\alpha_1 = \arctan \kappa_1$ (see the text above (9) for the definition of that quantity), a corresponding eigenfunction being w such that

$$w(x) = v(x_1, x_3),$$

where v is an eigenfunction of (8) associated with $\mu_1^{\alpha_1}$. Now let us consider the situation $\kappa_2 > 0$ small. Then the map

$$\Omega_{1-}^\kappa \ni x \mapsto \left(x_1, \frac{x_2 - \kappa_2 x_3}{1 - \kappa_2 x_3}, x_3 \right) \in \Omega_{1-}^{(\kappa_1, 0)} \quad (25)$$

is a diffeomorphism whose Jacobian matrix is close to the identity and whose Hessian matrix is small. Using these properties, we deduce that the discrete spectrum of the problem (24) is still non-empty for κ_2 small enough. This comes from the fact that the cut-off point of the essential spectrum satisfies the estimate

$$|\tau_+^{\kappa_2} - \pi^2| \leq C_+ \kappa_2$$

and the first (smallest) eigenvalue of the discrete spectrum, which is simple¹, admits the expansion

$$\tau_1^{\kappa_2} = \mu_1^{\alpha_1} + \kappa_2 \tau_1' + \tilde{\tau}_1^{\kappa_2} \quad (26)$$

with $|\tilde{\tau}_1^{\kappa_2}| \leq C \kappa_2^2$. Here $C > 0$ is a constant independent of κ_2 . These properties can be justified using classical results of the perturbation theory for linear operators, see e.g. [13, Ch. 7], [4, Ch. 10], [20, Ch. XII]. From the minimum principle, to establish (23), we see that it suffices to show that

$$\tau_1' = \left. \frac{d\tau_1^{\kappa_2}}{d\kappa_2} \right|_{\kappa_2=0} > 0. \quad (27)$$

Let $w_1^{\kappa_2}$ be an eigenfunction of Problem (24) associated with $\tau_1^{\kappa_2}$. Together with (29), consider the asymptotic ansatz

$$w_1^{\kappa_2}(x) = v(x_1, x_3) + \kappa_2 w_1'(x) + \tilde{w}_1^{\kappa_2}(x) \quad (28)$$

¹Since Ω_{1-}^κ is unbounded, we cannot directly apply the classical Krein-Rutman theorem to prove that the first eigenvalue $\tau_1^{\kappa_2}$ of (24) is simple. However, this can be established for example by exploiting that the eigenfunctions associated with $\tau_1^{\kappa_2}$ are exponentially decaying at infinity and by approximating them by eigenfunctions of operators set in bounded domains (where we can apply the Krein-Rutman theorem). With this, we show that each eigenfunction associated with $\tau_1^{\kappa_2}$ is either non-negative or non-positive in Ω_{1-}^κ , which is possible only if $\tau_1^{\kappa_2}$ is a simple eigenvalue. In the proof, one needs to use the fact that eigenfunctions cannot vanish on sets of positive area owing to the theorem on unique continuation.

where $\tilde{w}_1^{\kappa_2}$ is a small remainder. Insert (29), (28) into (24) and collect the terms of order κ_2 . We obtain

$$\begin{cases} -\Delta_x w'_1 - \mu_1^{\alpha_1} w'_1 = \tau'_1 v & \text{in } \Omega_{1-}^{(\kappa_1, 0)} \\ w'_1 = 0 & \text{on } \{x \in \partial\Omega_{1-}^\kappa \mid x_3 = 0 \text{ or } x_3 = 1\}. \end{cases} \quad (29)$$

As for the Neumann boundary condition of (24), using in particular that on Γ_1^κ ,

$$\partial_\nu \cdot = (1 + \kappa_2^2)^{-1/2} \left(-\frac{\partial \cdot}{\partial x_2} + \kappa_2 \frac{\partial \cdot}{\partial x_3} \right),$$

at order κ_2 , we find

$$-\frac{\partial w'_1}{\partial x_2}(x_1, 0, x_3) = -\frac{\partial v}{\partial x_3}(x_1, x_3), \quad \frac{\partial w'_1}{\partial x_2}(x_1, 1, x_3) = 0, \quad (x_1, x_3) \in \Pi^{\alpha_1}. \quad (30)$$

Since the smallest eigenvalue $\mu_1^{\alpha_1}$ is simple, there exists only one compatibility condition to satisfy to ensure that the problem (29)–(30) has a non trivial solution. It can be written as

$$\begin{aligned} \tau'_1 &= \tau'_1 \|v; L^2(\Pi^{\alpha_1})\|^2 \\ &= -\int_{\Omega_{1-}^{(\kappa_1, 0)}} v(\Delta_x w'_1 + \mu_1^{\alpha_1} w'_1) dx = \int_{\Gamma_1^{(\kappa_1, 0)}} v(x_1, x_3) \frac{\partial w'_1}{\partial x_2}(x_1, 0, x_3) ds \\ &= \int_{\Pi^{\alpha_1}} v(\xi_1, \xi_2) \frac{\partial v}{\partial \xi_2}(\xi_1, \xi_2) d\xi_1 d\xi_2 = \frac{1}{2} \cos \alpha_1 \int_{L^{(\kappa_1, 0)}} v^2 d\ell > 0 \end{aligned}$$

where $L^{(\kappa_1, 0)} := \{(\xi_1, \xi_2) \in \mathbb{R}^2 \mid \xi_1 = \xi_2 \tan \alpha_1, \xi_2 \in (0, 1)\}$. This shows (27) which guarantees that estimate (23) is valid according to the minimum principle. Therefore the proof of Proposition 5.1 is complete. \square

6 Existence of eigenvalues for κ_2 close to $\kappa_1 > 0$

We start this section by proving that the discrete spectrum $\sigma_d(A^\kappa)$ of the operator A^κ can also be non-empty for certain positive κ_2 . This happens for example in the case $\kappa_1 = \kappa_2$, which we now assume. We adapt the proof of [2, Thm. 2] and exhibit a function $\varphi \in H_0^1(\Omega^\kappa; \Sigma^\kappa)$ satisfying (11). First, note that for $\kappa_1 = \kappa_2$, the domain Ω^κ is symmetric with respect to the “bisector” cross-section

$$\Upsilon^\kappa := \{x \in \Omega^\kappa \mid x_1 = x_2\}.$$

Let us divide Ω^κ into the two congruent domains

$$\Omega_\lambda^\kappa := \{x \in \Omega^\kappa \mid x_1 > x_2\} \quad \text{and} \quad \Omega_\zeta^\kappa := \{x \in \Omega^\kappa \mid x_2 > x_1\}. \quad (31)$$

Accordingly, we set

$$\psi^\varepsilon(x) = \begin{cases} e^{-\varepsilon x_1} v(x_2, x_3) & \text{in } \Omega_\lambda^\kappa \\ e^{-\varepsilon x_2} v(x_1, x_3) & \text{in } \Omega_\zeta^\kappa \end{cases} \quad (32)$$

where v is as in (13). Since ψ^ε is continuous on Υ^κ and decays exponentially at infinity, it belongs to $H_0^1(\Omega^\kappa; \Sigma^\kappa)$. Moreover, we have

$$\begin{aligned} &\|\nabla_x \psi^\varepsilon; L^2(\Omega_\lambda^\kappa)\|^2 - \mu_1^{\alpha_1} \|\psi^\varepsilon; L^2(\Omega_\lambda^\kappa)\|^2 \\ &= -\int_{\Omega_\lambda^\kappa} e^{-2\varepsilon x_1} v(x_2, x_3) (\Delta_x v(x_2, x_3) + (\mu_1^{\alpha_1} + \varepsilon^2) v(x_2, x_3)) dx \\ &\quad + \int_{\Upsilon^\kappa} e^{-\varepsilon x_1} v(x_2, x_3) \partial_\nu (e^{-\varepsilon x_1} v(x_2, x_3)) ds =: I_{\Omega^\kappa}^\varepsilon + I_{\Upsilon^\kappa}^\varepsilon. \end{aligned} \quad (33)$$

Using that v solves (8), we get $I_{\Omega^\kappa}^\varepsilon = O(\varepsilon)$. Now consider the integral $I_{\Upsilon^\kappa}^\varepsilon$. Define the new orthonormal basis $(\hat{e}_1, \hat{e}_2, \hat{e}_3)$ with

$$\hat{e}_1 = \frac{\sqrt{2}}{2} e_1 + \frac{\sqrt{2}}{2} e_2; \quad \hat{e}_2 = -\frac{\sqrt{2}}{2} e_1 + \frac{\sqrt{2}}{2} e_2; \quad \hat{e}_3 = e_3. \quad (34)$$

Remark that Υ^κ is included in the plane $(O, \hat{e}_1, \hat{e}_3)$. Let $(\hat{x}_1, \hat{x}_2, \hat{x}_3)$ denote the coordinates in the basis (34). We have

$$\begin{aligned} I_{\Upsilon^\kappa}^\varepsilon &= \int_{\Upsilon^\kappa} e^{-\varepsilon\sqrt{2}(\hat{x}_1-\hat{x}_2)/2} v \frac{\partial}{\partial \hat{x}_2} (e^{-\varepsilon\sqrt{2}(\hat{x}_1-\hat{x}_2)/2} v) d\hat{x}_1 d\hat{x}_3 \\ &= \int_{\Upsilon^\kappa} \frac{\varepsilon\sqrt{2}}{2} e^{-\varepsilon\sqrt{2}(\hat{x}_1-\hat{x}_2)} v^2 d\hat{x}_1 d\hat{x}_3 + \int_{\Upsilon^\kappa} \frac{1}{2} e^{-\varepsilon\sqrt{2}(\hat{x}_1-\hat{x}_2)} \frac{\partial(v^2)}{\partial \hat{x}_2} d\hat{x}_1 d\hat{x}_3. \end{aligned} \quad (35)$$

Exploiting the exponential decay of $v(\xi)$ as $\xi_1 \rightarrow +\infty$, (see Section 2), one finds that the first integral of the right hand side above is $O(\varepsilon)$. For the second one, using that v is independent of x_1 , we can write

$$0 = \frac{\partial(v^2)}{\partial x_1} = \frac{\sqrt{2}}{2} \frac{\partial(v^2)}{\partial \hat{x}_1} - \frac{\sqrt{2}}{2} \frac{\partial(v^2)}{\partial \hat{x}_2}.$$

Remarking also that $\hat{x}_2 = 0$ on Υ^κ , this gives

$$\begin{aligned} &\int_{\Upsilon^\kappa} \frac{1}{2} e^{-\varepsilon\sqrt{2}(\hat{x}_1-\hat{x}_2)} \frac{\partial(v^2)}{\partial \hat{x}_2} d\hat{x}_1 d\hat{x}_3 = \int_{\Upsilon^\kappa} \frac{1}{2} e^{-\varepsilon\sqrt{2}\hat{x}_1} \frac{\partial(v^2)}{\partial \hat{x}_1} d\hat{x}_1 d\hat{x}_3 \\ &= \int_{\Upsilon^\kappa} \frac{\varepsilon\sqrt{2}}{2} e^{-\varepsilon\sqrt{2}\hat{x}_1} v^2 d\hat{x}_1 d\hat{x}_3 + \int_{L^\kappa} \frac{1}{2} e^{-\varepsilon\sqrt{2}\hat{x}_1} v^2 \nu \cdot \hat{e}_1 d\ell \end{aligned} \quad (36)$$

where $L^\kappa := \{x \in \mathbb{R}^3 \mid x_j = \kappa_j x_3, j = 1, 2, x_3 \in (0, 1)\}$ and where ν stands for the outward unit normal vector to Υ^κ (in the plane $(O, \hat{e}_1, \hat{e}_3)$). Using that $\kappa_1 = \kappa_2 > 0$, we find $\nu \cdot \hat{e}_1 < 0$ on L^κ . Since there holds $v \not\equiv 0$ on L^κ , gathering (35) and (36), we deduce that we have $I_{\Upsilon^\kappa}^\varepsilon < 0$ for ε small enough. From (33), we deduce

$$\|\nabla_x \psi^\varepsilon; L^2(\Omega_\lambda^\kappa)\|^2 - \mu_1^{\alpha_1} \|\psi^\varepsilon; L^2(\Omega_\lambda^\kappa)\|^2 < 0$$

for ε small enough. Then by symmetry, we obtain

$$\|\nabla_x \psi^\varepsilon; L^2(\Omega^\kappa)\|^2 - \mu_1^{\alpha_1} \|\psi^\varepsilon; L^2(\Omega^\kappa)\|^2 = 2\|\nabla_x \psi^\varepsilon; L^2(\Omega_\lambda^\kappa)\|^2 - 2\mu_1^{\alpha_1} \|\psi^\varepsilon; L^2(\Omega_\lambda^\kappa)\|^2 < 0.$$

We conclude that the inequality (11) is satisfied by the function (32) which proves the following statement.

Theorem 6.1. *For $\kappa_1 = \kappa_2 > 0$, the discrete spectrum $\sigma_d(A^\kappa)$ of the operator A^κ is not empty.*

Since the eigenvalues of the discrete spectrum are stable with respect to small perturbations of the operator, Theorem 6.1 and diffeomorphisms similar to (25) imply that $\sigma_d(A^\kappa)$ is not empty for κ_2 in a neighbourhood of κ_1 . With Proposition 5.1, this allows us to introduce $h(\kappa_1) \in (0, \kappa_1)$ as the infimum of the numbers δ such that $\sigma_d(A^\kappa)$ is non-empty for all $\kappa_2 \in (\delta, \kappa_1]$.

On the other hand, we have the following monotonicity result:

Lemma 6.2. *Consider some $\kappa = (\kappa_1, \kappa_2)$ with $\kappa_1 > 0$ and $\kappa_2 \in (0, \kappa_1]$ such that A^κ has a non-empty discrete spectrum. Let λ_1^κ denote the first (smallest) eigenvalue of $\sigma_d(A^\kappa)$. For $\varepsilon > 0$ small, set $\kappa^\varepsilon := (\kappa_1, \kappa_2 + \varepsilon)$ and denote by $\lambda_1^{\kappa^\varepsilon}$ the first eigenvalue of $\sigma_d(A^{\kappa^\varepsilon})$. Then, we have*

$$\lambda_1^{\kappa^\varepsilon} < \lambda_1^\kappa. \quad (37)$$

Proof. Using again the minimum principle, we can write

$$\lambda_1^{\kappa^\varepsilon} = \min_{\psi^\varepsilon \in \mathbf{H}_0^1(\Omega^{\kappa^\varepsilon}; \Sigma^{\kappa^\varepsilon}) \setminus \{0\}} \frac{\|\nabla_x \psi^\varepsilon; \mathbf{L}^2(\Omega^{\kappa^\varepsilon})\|^2}{\|\psi^\varepsilon; \mathbf{L}^2(\Omega^{\kappa^\varepsilon})\|^2}. \quad (38)$$

Now define the function ψ^ε such that

$$\psi^\varepsilon(x) = u^\kappa \left(x_1, \frac{\kappa_2 x_2}{\kappa_2 + \varepsilon}, x_3 \right),$$

where $u^\kappa \in \mathbf{H}_0^1(\Omega^\kappa; \Sigma^\kappa)$ is an eigenfunction associated with the first eigenvalue of $\sigma_d(A^\kappa)$. Clearly ψ^ε is a non zero element of $\mathbf{H}_0^1(\Omega^{\kappa^\varepsilon})$. Besides, we find

$$\|\psi^\varepsilon; \mathbf{L}^2(\Omega^{\kappa^\varepsilon})\|^2 = \frac{\kappa_2 + \varepsilon}{\kappa_2} \|u^\kappa; \mathbf{L}^2(\Omega^\kappa)\|^2$$

$$\text{and} \quad \|\nabla_x \psi^\varepsilon; \mathbf{L}^2(\Omega^{\kappa^\varepsilon})\|^2 = \frac{\kappa_2}{\kappa_2 + \varepsilon} \left\| \frac{\partial u^\kappa}{\partial x_2}; \mathbf{L}^2(\Omega^\kappa) \right\|^2 + \frac{\kappa_2 + \varepsilon}{\kappa_2} \sum_{j=1,3} \left\| \frac{\partial u^\kappa}{\partial x_j}; \mathbf{L}^2(\Omega^\kappa) \right\|^2.$$

According to (38), these identities imply

$$\begin{aligned} \lambda_1^{\kappa^\varepsilon} &\leq \|u^\kappa; \mathbf{L}^2(\Omega^\kappa)\|^{-2} \left(\frac{\kappa_2^2}{(\kappa_2 + \varepsilon)^2} \left\| \frac{\partial u^\kappa}{\partial x_2}; \mathbf{L}^2(\Omega^\kappa) \right\|^2 + \sum_{j=1,3} \left\| \frac{\partial u^\kappa}{\partial x_j}; \mathbf{L}^2(\Omega^\kappa) \right\|^2 \right) \\ &\leq \frac{\|\nabla_x u^\kappa; \mathbf{L}^2(\Omega^\kappa)\|^2}{\|u^\kappa; \mathbf{L}^2(\Omega^\kappa)\|^2} = \lambda_1^\kappa. \end{aligned}$$

The strict inequality in (37) follows from the fact that the derivative $\partial u^\kappa / \partial x_2$ cannot be null in the whole domain Ω^κ . This completes the proof of the lemma. \square

According to relation (37), the function $\kappa_2 \mapsto \lambda_1^\kappa$ is strictly decreasing on $(h(\kappa_1), \kappa_1)$. Besides, Lemma 6.2 ensures that $\sigma_d(A^\kappa)$ cannot be non-empty for some $\tilde{h}(\kappa_1) \in (0, h(\kappa_1))$ otherwise $\sigma_d(A^\kappa)$ would be non-empty for all $\kappa_2 \in (\tilde{h}(\kappa_1), \kappa_1]$ which contradicts the definition of $h(\kappa_1)$. This completes the proof of the item 2) of Theorem 3.2.

Remark 6.3. For $\kappa_2 \in [-\kappa_1, 0)$, we have seen in Section 4 that $\sigma_d(A^\kappa)$ is non-empty. Let λ_1^κ denote the smallest eigenvalue of $\sigma_d(A^\kappa)$. By adapting the proof of Lemma 6.2, one establishes that the map $\kappa_2 \mapsto \lambda_1^\kappa$ is strictly increasing on $[-\kappa_1, 0)$. Together with Lemma 6.2, this shows the item 3) of Theorem 3.2.

7 Finiteness of the discrete spectrum

Finally, we establish the item 4) of Theorem 3.2 and so assume that $\kappa_2 \in (-\kappa_1, \kappa_1)$. Set again $\alpha_1 = \arctan \kappa_1$, $\alpha_2 = \arctan \kappa_2$. Since $|\alpha_2| < \alpha_1$, similarly to (10), we have

$$\lambda_{\dagger}^\kappa = \mu_1^{\alpha_1} < \mu_1^{|\alpha_2|} = \mu_1^{\alpha_2}. \quad (39)$$

We remind the reader that $\mu_1^{\alpha_j}$ stands for the smallest eigenvalue of the 2D problem (8) set in the pointed strip Π^{α_j} appearing in (7). Observe that Π^{α_2} can be obtained from $\Pi^{-\alpha_2}$ by a symmetry with respect to the line $\xi_2 = 1/2$ and a translation, which ensures that $\mu_1^{-\alpha_2} = \mu_1^{\alpha_2}$ and so $\mu_1^{|\alpha_2|} = \mu_1^{\alpha_2}$.

For $R > 0$, define the truncated pointed strip

$$\Pi^{\alpha_2}(R) := \{(\xi_1, \xi_2) \in \Pi^{\alpha_2} \mid \xi_1 < R\}$$

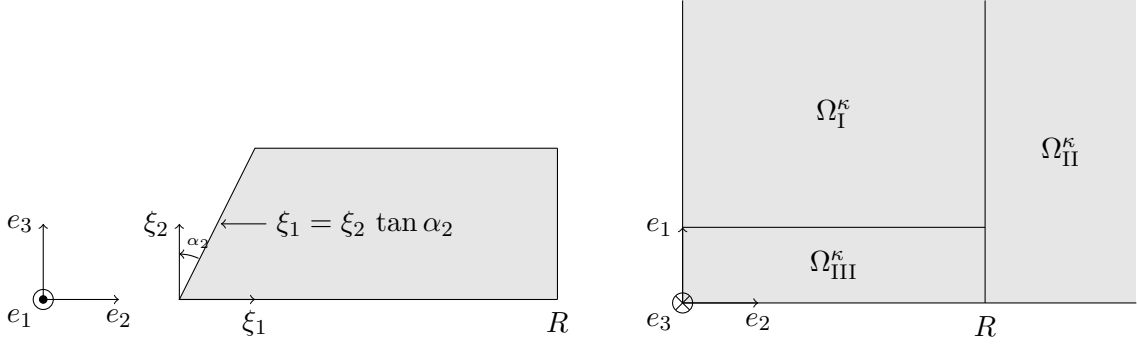

Figure 7: Left: truncated pointed strip $\Pi^{\alpha_2}(R)$. Right: bottom view of the decomposition of Ω^κ .

(see Figure 7 left) and consider the problem

$$\begin{cases} -\Delta_\xi v = \mu v & \text{in } \Pi^{\alpha_2}(R) \\ v = 0 & \text{on } \{\xi \in \partial\Pi^{\alpha_2}(R) \mid \xi_2 = 0 \text{ or } \xi_2 = 1\} \\ \partial_\nu v = 0 & \text{on } \{\xi \in \partial\Pi^{\alpha_2}(R) \mid \xi_2 \neq 0 \text{ and } \xi_2 \neq 1\}. \end{cases} \quad (40)$$

Denote by $\mu_1^{\alpha_2}(R)$ the smallest eigenvalue of (40). Since $\mu_1^{\alpha_2}(R)$ converges to $\mu_1^{\alpha_2}$ as $R \rightarrow +\infty$, according to (39), we can fix $R > |\kappa_2|$ such that

$$\mu_1^{\alpha_2}(R) > \lambda_\dagger^\kappa. \quad (41)$$

Then let us divide Ω^κ into the three domains

$$\begin{aligned} \Omega_I^\kappa &:= \{x \in \Omega^\kappa \mid x_1 > \kappa_1 \text{ and } x_2 < R\}, & \Omega_{II}^\kappa &:= \{x \in \Omega^\kappa \mid x_2 > R\}, \\ \Omega_{III}^\kappa &:= \{x \in \Omega^\kappa \mid x_1 < \kappa_1 \text{ and } x_2 < R\} \end{aligned}$$

(see the representation of Figure 7 right). Using (41), we obtain

$$\|\nabla_x \psi; L^2(\Omega_I^\kappa)\|^2 \geq \lambda_\dagger^\kappa \|\psi; L^2(\Omega_I^\kappa)\|^2 \quad \forall \psi \in H_0^1(\Omega^\kappa; \Sigma^\kappa). \quad (42)$$

On the other hand, from (22), we get

$$\|\nabla_x \psi; L^2(\Omega_{III}^\kappa)\|^2 \geq \lambda_\dagger^\kappa \|\psi; L^2(\Omega_{III}^\kappa)\|^2 \quad \forall \psi \in H_0^1(\Omega^\kappa; \Sigma^\kappa). \quad (43)$$

Besides, since Ω_{III}^κ is bounded, the max-min principle ([4, Thm. 10.2.2]) guarantees that there is $n \in \mathbb{N} := \{0, 1, 2, \dots\}$ such that

$$\lambda_\dagger^\kappa \leq \max_{E \subset \mathcal{E}_n} \inf_{\psi \in E \setminus \{0\}} \frac{\int_{\Omega_{III}^\kappa} |\nabla \psi|^2 dx}{\int_{\Omega_{III}^\kappa} \psi^2 dx}, \quad (44)$$

where \mathcal{E}_n denotes the set of subspaces of $H_0^1(\Omega_{III}^\kappa; \Sigma_0 \cap \partial\Omega^\kappa) := \{\varphi \in H^1(\Omega_{III}^\kappa) \mid \varphi = 0 \text{ on } \Sigma_0 \cap \partial\Omega^\kappa\}$ of codimension n . Gathering (42)–(44), we deduce that there holds

$$\lambda_\dagger^\kappa \leq \max_{E \subset \tilde{\mathcal{E}}_n} \inf_{\psi \in E \setminus \{0\}} \frac{\int_{\Omega^\kappa} |\nabla \psi|^2 dx}{\int_{\Omega^\kappa} \psi^2 dx},$$

where this times $\tilde{\mathcal{E}}_n$ stands for the set of subspaces of $H_0^1(\Omega^\kappa; \Sigma_0)$ of codimension n . From the max-min principle, this proves that $\sigma_d(A^\kappa)$ contains at most n (depending on κ) eigenvalues.

Remark 7.1. *Our simple proof above does not work to show that $\sigma_d(A^\kappa)$ is discrete when $\kappa_2 = \pm\kappa_1$. However we do not expect particular phenomenon and think the result also holds in this case. It is proved in [6, Thm. 1.2] when $\kappa_2 = \kappa_1 = 1$.*

8 Numerics and discussion

In this section, we illustrate some of the results above. In Figure 8, we represent an approximation of the first eigenvalue of the 2D problem (8) set in the pointed strip Π^{α_1} with respect to $\alpha_1 \in (0, 9\pi/20)$. We use a rather crude method which consists in truncating the domain at $\xi_2 = 12$ (see the picture of Figure 7 left) and imposing homogeneous Dirichlet boundary condition on the artificial boundary. Then we compute the spectrum in this bounded geometry by using a classical P2 finite element method. To proceed, we use the library `Freefem++` [11] and display the results with `Matlab`² and `Paraview`³. The values we get are coherent with the ones recalled in (9). For more details concerning the numerical analysis of this problem, we refer the reader to [7]. In this work, one can also find an interesting study concerning the case $\alpha \rightarrow (\pi/2)^-$.

In Figure 9–11, we fix $\kappa_1 = 1$ (equivalently $\alpha_1 = \pi/4$) and compute the first eigenvalue of $\sigma_d(A^\kappa)$ for $\kappa_2 \in \{-1, -0.1, 1\}$. For $\kappa_1 = 1$, the bound of the essential spectrum of A^κ is $\lambda_{\dagger}^\kappa \approx 0.929\pi^2$ (see Figure 8 as well as [6]). For each of the three κ_2 , in agreement with Theorem 3.2, we find an eigenvalue below the essential spectrum. Actually, in each situation our numerical experiments seem to indicate that there is only one eigenvalue in the discrete spectrum, which is a result that we have not proved. Interestingly, for $\kappa_2 = -0.1$ (Figure 10), the eigenfunction is not particularly localized at the intersection of the oblique sides. This is related to the so-called Agmon estimates which guarantee that the decay rate coincides with the square root of the difference between the lower bound of the essential spectrum λ_{\dagger}^κ and the eigenvalue λ_1^κ (see [1, 8]). For $\kappa_2 = -0.1$ the quantity $\lambda_{\dagger}^\kappa - \lambda_1^\kappa$ is rather small. We emphasize that here we simply compute the spectrum of the Laplace operator with mixed boundary conditions in the bounded domain $\{x \in \Omega^\kappa \mid x_1 < 6 \text{ and } x_2 < 6\}$. At $x_1 = 6$ and $x_2 = 6$, we impose homogeneous Neumann boundary condition. Admittedly, this is a very naive approximation, especially in the case of Figure 10. Our approximation lacks precision in that situation, this is the reason why we do not give the value of the corresponding eigenvalue.

In Figure 12, we represent eigenfunctions associated with two different eigenvalues of $\sigma_d(A^\kappa)$ for $\kappa = (3, -3)$. For the 2D problem (8) in the pointed strip, the cardinal of the discrete spectrum can be made as large as desired by considering sufficiently sharp angles. We imagine that a similar phenomenon occurs in our geometry Ω^κ . However to prove such a result is an open problem. At least the numerics of Figure 12 suggest that we can have more than one eigenvalue in $\sigma_d(A^\kappa)$.

As mentioned in the introduction, the fact that the discrete spectrum of A^κ for $\kappa = (1, 1)$ is not empty ensures that the Dirichlet Laplacian in the so-called Fichera layer \mathcal{F} of Figure 1 right admits an eigenvalue below the essential spectrum. This can be proved by playing with symmetries and reconstructing \mathcal{F} from three versions of $\Omega^{(1,1)}$. Now, gluing six domains $\Omega^{(1,-1)}$, we can create the cubical structure pictured in Figure 13 (note that its boundary is not Lipschitz). Then, from Theorem 3.2 which guarantees that $\sigma_d(A^\kappa)$ contains at least one eigenvalue, we deduce that the Dirichlet Laplacian in this geometry has at least one eigenvalue.

²Matlab, <http://www.mathworks.com/>.

³Paraview, <http://www.paraview.org/>.

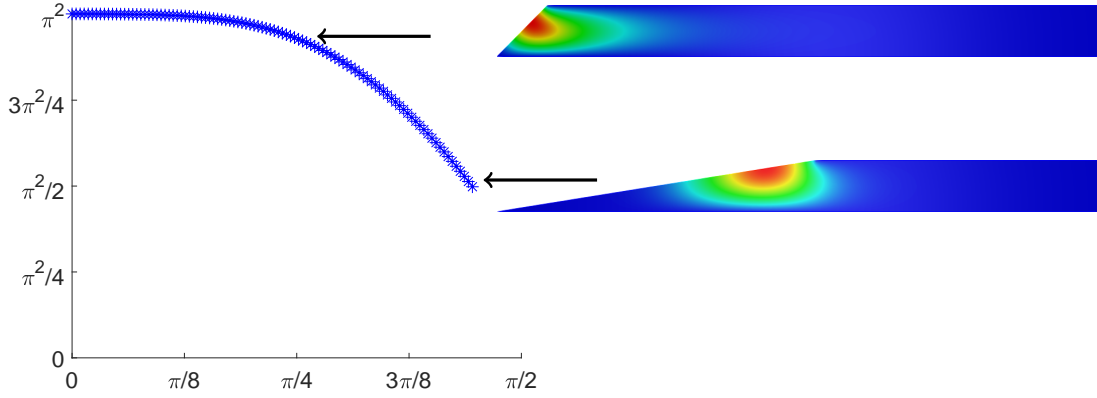

Figure 8: Curve $\alpha_1 \mapsto \mu_1^{\alpha_1}$ for $\alpha_1 \in (0, 9\pi/20)$. According to Theorem 2.1, this gives the bound $\lambda_{\dagger}^{\kappa}$ of the essential spectrum of A^{κ} . The two pictures correspond to eigenfunctions associated with $\mu_1^{\alpha_1}$ for $\alpha_1 = \pi/4$ and $\alpha_1 = 9\pi/20$.

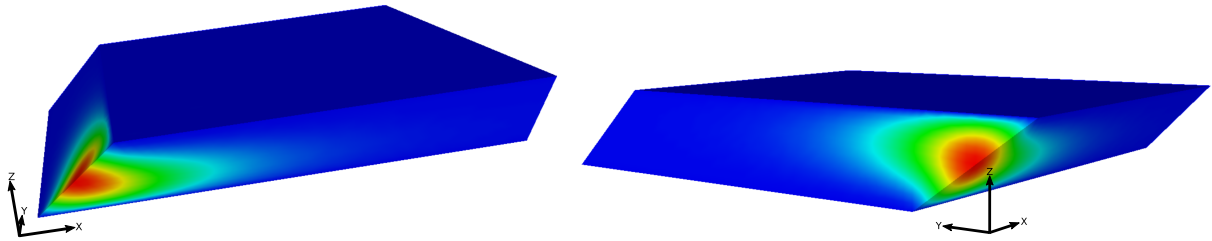

Figure 9: Two views of an eigenfunction associated with the first eigenvalue of $\sigma_d(A^{\kappa})$ for $\kappa = (1, -1)$. We find $\lambda_1^{\kappa} \approx 0.81\pi^2$.

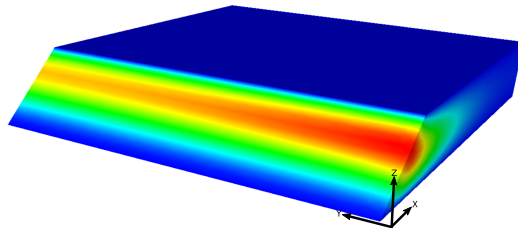

Figure 10: Eigenfunction associated with the first eigenvalue of $\sigma_d(A^{\kappa})$ for $\kappa = (1, -0.1)$.

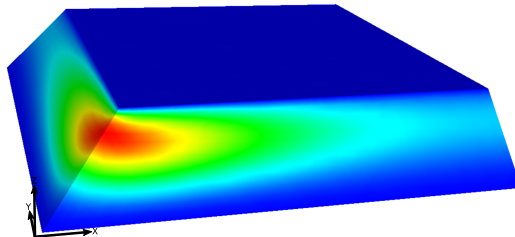

Figure 11: Eigenfunction associated with the first eigenvalue of $\sigma_d(A^{\kappa})$ for $\kappa = (1, 1)$. We find $\lambda_1^{\kappa} \approx 0.90\pi^2$.

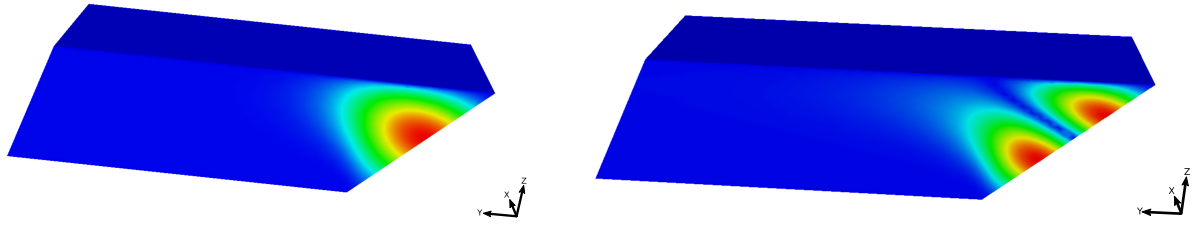

Figure 12: Eigenfunctions associated with two different eigenvalues of $\sigma_d(A^\kappa)$ for $\kappa = (3, -3)$.

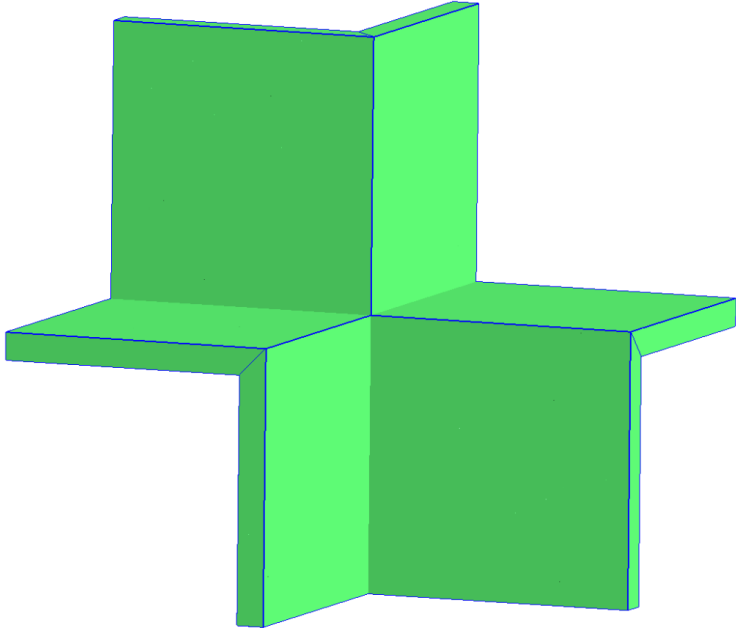

Figure 13: Cubical structure obtained by gluing six domains Ω^κ with $\kappa = (1, -1)$.

Appendix

Here we show that the Dirichlet Laplacian in Ω^κ has no isolated eigenvalue nor eigenvalues embedded in the essential spectrum.

Proposition 8.1. *Fix $\kappa = (\kappa_1, \kappa_2) \in \mathbb{R}^2$. Assume that $u \in H^1(\Omega^\kappa)$ satisfies*

$$\begin{cases} -\Delta_x u = \lambda u & \text{in } \Omega^\kappa \\ u = 0 & \text{on } \partial\Omega^\kappa \end{cases} \quad (45)$$

for some $\lambda \in \mathbb{C}$. Then there holds $u \equiv 0$ in Ω^κ .

Proof. The result is clear when $\lambda \in \mathbb{C} \setminus (0, +\infty)$. Let us apply the Rellich trick [21] to deal with the case $\lambda > 0$. If u solves (45), the function $\partial_{x_1} u$ satisfies

$$\begin{cases} -\Delta_x(\partial_{x_1} u) = \lambda \partial_{x_1} u & \text{in } \Omega^\kappa \\ \partial_{x_1} u = 0 & \text{on } \Sigma^\kappa. \end{cases} \quad (46)$$

Note that since Ω^κ is convex, classical regularity results (see e.g., the second basic inequality in [14, §II.6]) ensure that u belongs to $H^2(\Omega^\kappa)$ so that $\partial_{x_1} u$ falls in $H^1(\Omega^\kappa)$. Multiplying (45) by $\partial_{x_1} u$, (46) by u , integrating by parts and taking the difference, we obtain

$$0 = \int_{\Gamma_2^\kappa} \frac{\partial u}{\partial \nu} \frac{\partial u}{\partial x_1} ds \quad (47)$$

(note that $\partial_{x_1} u = 0$ on Γ_1^κ because $u = 0$ on Γ_1^κ). On Γ_2^κ , the fact that $u = 0$ implies

$$-\kappa_1 \frac{\partial u}{\partial x_1} = \frac{\partial u}{\partial x_3}.$$

Therefore we get

$$\frac{\partial u}{\partial \nu} = (1 + \kappa_1^2)^{-1/2} \left(-\frac{\partial u}{\partial x_1} + \kappa_1 \frac{\partial u}{\partial x_3} \right) = -\sqrt{1 + \kappa_1^2} \frac{\partial u}{\partial x_1}.$$

Using this in (47) gives $\partial u / \partial \nu = 0$ on Γ_2^κ . Since we also have $u = 0$ on Γ_2^κ and $\Delta_x u + \lambda u = 0$ in Ω^κ , the theorem of unique continuation (see e.g. [3], [5, Thm. 8.6]) guarantees that $u \equiv 0$ in Ω^κ . \square

Acknowledgements

The work of the second author was supported by the Russian Science Foundation, project 22-11-00046.

References

- [1] S. Agmon. *Lectures on exponential decay of solutions of second-order elliptic equations: bounds on eigenfunctions of N -body Schrödinger operators*, volume 29 of *Math. Notes*. Princeton University Press, 2014.
- [2] F.L. Bakharev and A.I. Nazarov. Existence of the discrete spectrum in the Fichera layers and crosses of arbitrary dimension. *J. Funct. Anal.*, 281(4):109071, 2021.
- [3] L. Bers, F. John, and M. Schechter. *Partial differential equations*. Springer-Verlag, John Wiley, 1964.
- [4] M.Sh. Birman and M.Z. Solomjak. *Spectral theory of selfadjoint operators in Hilbert space*. Mathematics and its Applications (Soviet Series). D. Reidel Publishing Co., Dordrecht, 1987.

- [5] D. Colton and R. Kress. *Inverse acoustic and electromagnetic scattering theory. 3rd ed.*, volume 93 of *Appl. Math. Sci.* Springer-Verlag, Berlin, 2013.
- [6] M. Dauge, Y. Lafranche, and T. Ourmières-Bonafos. Dirichlet spectrum of the Fichera layer. *Integral Equ. Oper. Theory*, 90(5):60, 2018.
- [7] M. Dauge, Y. Lafranche, and N. Raymond. Quantum waveguides with corners. In *ESAIM Proc.*, volume 35, pages 14–45, 2012.
- [8] M. Dauge and N. Raymond. Plane waveguides with corners in the small angle limit. *J. Math. Phys.*, 53(12):123529, 2012.
- [9] P. Exner, P. Seba, and P. Stovicek. On existence of a bound state in an L-shaped waveguide. *Czech J. Phys.*, 39:1181–1191, 1989.
- [10] G. Fichera. Asymptotic behaviour of the electric field and density of the electric charge in the neighbourhood of singular points of a conducting surface. *Russ. Math. Surv.*, 30(3):107, 1975.
- [11] F. Hecht. New development in freefem++. *J. Numer. Math.*, 20(3-4):251–265, 2012. <http://www3.freefem.org/>.
- [12] I.V. Kamotskii and S.A. Nazarov. On eigenfunctions localized in a neighborhood of the lateral surface of a thin domain. *J. Math. Sci.*, 101(2):2941–2974, 2000.
- [13] T. Kato. *Perturbation theory for linear operators*. Springer-Verlag, Berlin, reprint of the corr. print. of the 2nd ed. 1980 edition, 1995.
- [14] O.A. Ladyzhenskaya. *The Boundary Value Problems of Mathematical Physics*. Nauka, Moscow, 1973. (English transl.: Springer-Verlag, New York, 1985).
- [15] J.-L. Lions and E. Magenes. *Problèmes aux limites non homogènes et applications*. Dunod, 1968.
- [16] S.A. Nazarov. Variational and asymptotic methods for finding eigenvalues below the continuous spectrum threshold. *Sibirsk. Mat. Zh.*, 51:1086–1101, 2010. (English transl. *Siberian Math. J.* 51, 866–878, 2010.).
- [17] S.A. Nazarov. Discrete spectrum of cranked, branching, and periodic waveguides. *Algebra i analiz*, 23(2):206–247, 2011. (English transl.: *St. Petersburg Math.* 23:2, 351–379, 2012.).
- [18] S.A. Nazarov. Asymptotics of eigenvalues of the Dirichlet problem in a skewed \mathcal{T} -shaped waveguide. *Comput. Math. Math. Phys.*, 54:811–830, 2014.
- [19] S.A. Nazarov and A.V. Shanin. Trapped modes in angular joints of 2D waveguides. *Appl. Anal.*, 93:572–582, 2014.
- [20] M. Reed and B. Simon. *Methods of modern mathematical physics. IV. Analysis of operators*. Academic Press, New-York, 1978.
- [21] F. Rellich. Über das asymptotische Verhalten der Lösungen von $\Delta u + \lambda u = 0$ in unendlichen Gebieten. *Jahresber. Dtsch. Math.-Ver.*, 53:57–65, 1943.