



HAL
open science

Electrolytic capacitor: Properties and operation

Jami Toriki, Charles Joubert, Ali Sari

► **To cite this version:**

Jami Toriki, Charles Joubert, Ali Sari. Electrolytic capacitor: Properties and operation. Journal of Energy Storage, 2023, 58, pp.106330. 10.1016/j.est.2022.106330 . hal-04045102

HAL Id: hal-04045102

<https://hal.science/hal-04045102>

Submitted on 9 Jun 2023

HAL is a multi-disciplinary open access archive for the deposit and dissemination of scientific research documents, whether they are published or not. The documents may come from teaching and research institutions in France or abroad, or from public or private research centers.

L'archive ouverte pluridisciplinaire **HAL**, est destinée au dépôt et à la diffusion de documents scientifiques de niveau recherche, publiés ou non, émanant des établissements d'enseignement et de recherche français ou étrangers, des laboratoires publics ou privés.

Electrolytic capacitor: properties and operation

Jami TORKI¹, Charles JOUBERT¹ and Ali SARI¹

¹Université de Lyon, Université Claude Bernard Lyon 1, Ecole Centrale de Lyon, INSA Lyon, CNRS
UMR5005, Ampère, Villeurbanne 69622, France
jami.torki@univ-lyon1.fr; charles.joubert@univ-lyon1.fr; ali.sari@univ-lyon1.fr

Highlights:

- A comprehensive review on the properties of electrolytic capacitor are presented
- Characteristics of three different types of electrolytic capacitors are explained
- The article reviews the study of predictive maintenance to anticipate breakdowns
- Methods based on the variation of aging indicators for aging laws are listed

Abstract: Due to their high specific volumetric capacitance, electrolytic capacitors are used in many fields of power electronics, mainly for filtering and energy storage functions. Their characteristics change strongly with frequency, temperature and aging time. Electrolytic capacitors are among the components whose lifetime has the greatest influence on the reliability of electrical systems. Over the past three decades, many efforts in academic research have been devoted to improving reliability capacitor. Industrial applications require more reliable power electronic products. It is in this context that the different electrolytic capacitors and their characteristics are discussed. The aging process of aluminum electrolytic capacitors is explained. Finally, this paper reviews existing methods of failure prognosis of electrolytic capacitors.

Keywords: Electrolytic capacitor, failure modes, aging law, predictive maintenance.

Contents

1. Electrolytic capacitors	2
1.1 Principle of electrolytic capacitors	2
1.2 Aluminum electrolytic capacitors.....	4
1.3 Types and features of electrolytic capacitors.....	8
1.3.1 Comparison of electrolytic capacitor types.....	8
1.3.2 Comparison of electrolytic capacitor parameters.....	10
2. Features and Failure modes	12
2.1 Series equivalent circuit model of a capacitor and characteristic	12
2.2 Maintenance.....	14
2.3 Mechanisms and failure mode	16
2.3.1 Non-solid electrolytic capacitor failure modes	16
2.3.2 Solid and polymer electrolytic capacitor failure modes.....	18
3. Aging process of non-solid electrolytic capacitor	19
3.1 Characterization of aging indicators of electrolytic capacitors	19
3.2 Aging models for electrolytic capacitors	22
3.3 Detect the aging of electrolytic capacitors.....	26

38 4. Conclusion 27
39 References 28
40

41 **1. Electrolytic capacitors**

42 Capacitors are used in many fields of electronics and their main uses are the following:

- 43 • Energy storage (data backup, system protection...),
- 44 • Power factor correction,
- 45 • Regulation of the output voltage of switch mode power supplies,
- 46 • Input or output filtering of static converters,
- 47 • Starting of electric motors.

48 There are different types of capacitors to meet the different electrical, thermal and mechanical
49 constraints associated with their use. Moreover, each capacitor will meet certain criteria such as
50 capacitance, voltage and size. There are therefore three different types of capacitors that can cover all
51 user needs: ceramic, film and electrolytic capacitors. Choosing the right capacitor for the system can
52 be very important because in some applications it is responsible for most of the failures. **Figure 1** shows
53 the distribution of failures among power electronic components [1] [2]. Among all the electric
54 components, capacitors are the most vulnerable in terms of level and time of failure, as analyzed in
55 [3]–[5]. They are considered as reliability critical components in power electronic converters, especially
56 capacitors for DC link applications. This literature focuses on one of the three main types of capacitors:
57 electrolytic capacitors. The remainder of this paper is organized as follows:

58 **Section 1** presents the principles of electrolytic capacitors, the construction and the different types of
59 electrolytic capacitors. **Section 2** describes the characteristics, the maintenance that can be applied on
60 capacitors and the failure indicators. **Section 3** discusses general characterization, aging laws, variation
61 of aging indicators and methods for detecting the aging of electrolytic capacitors. Finally, conclusions
62 are presented in **Section 4**.

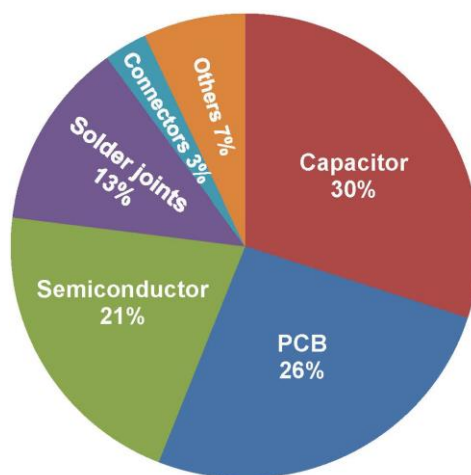

63
64 *Figure 1: Failure distribution in power electronic systems [6].*

65 **1.1 Principle of electrolytic capacitors**

66 Electrolytic capacitors consist of two electrodes (anode and cathode), a film oxide layer acting as a
67 dielectric and an electrolyte. The electrolyte brings the negative potential of the cathode closer to the
68 dielectric via ionic transport in the electrolyte [7] (see **Figure 2**). The electrolyte is either a liquid or a

69 polymer containing a high concentration of any type of ion, although generally some ions are preferred
 70 for electrolyte stability. There are mixtures of electrolyte with polymers [8] that provide better
 71 conduction and stability performance [9]–[11]. There are many different electrolytes, which can be
 72 separated into three categories: “Wet electrolytic capacitor”, which are electrolytic capacitors without
 73 electrolytic paper; “solid electrolyte” using a polymer, usually polythiophene, conducting electrons;
 74 “dry electrolytic” capacitors which still use a liquid electrolyte balancing the charge by ions.

75

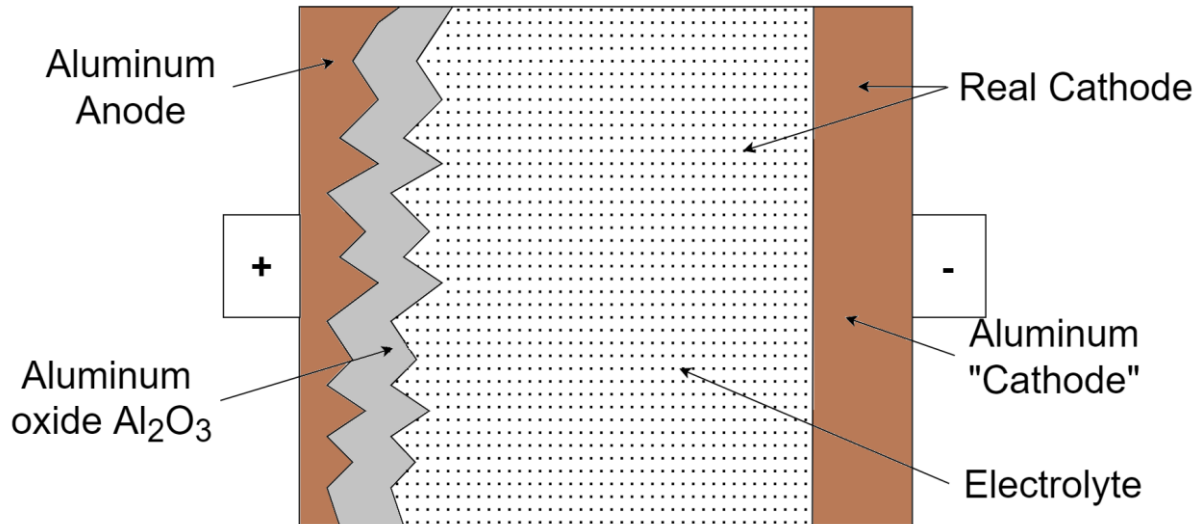

76

77 *Figure 2: Simplified diagram of the constitution of an aluminum electrolytic capacitor consisting of aluminum electrodes, an*
 78 *alumina dielectric and an electrolyte.*

79 The only physics that can store energy in a capacitor is electrostatics, allowing rapid and reversible
 80 processes. It is estimated that a capacitor has an efficiency of over 95% and can perform over one
 81 million charge and discharge cycles over its lifetime [12]. In the case of an ideal planar capacitor, the
 82 capacitance value can be calculated as follows:

$C = \frac{\epsilon_0 \epsilon_r S}{e}$	(1)
---	-----

83 With:

- 84 • ϵ_0 ($= 8,854 \cdot 10^{-12} \text{ F} \cdot \text{m}^{-1}$) the vacuum permittivity,
- 85 • ϵ_r the relative permittivity of the dielectric,
- 86 • S [m^2] the surface of the electrodes,
- 87 • e [m] the thickness of the dielectric.

88 Thus, it can be concluded that increasing the surface of the electrodes will allow the increase in
 89 capacitance. It is also possible to increase the capacitance by changing the relative permittivity of the
 90 dielectric used but also its thickness, which is why there is a multitude of capacitors classified into
 91 subgroups. As detailed below, electrolytic capacitors have a large electrode surface. Moreover, they
 92 have a thin oxide layer less than 1500 nm thick (see **Table 2**) [13]. One can understand that the
 93 electrolytic capacitors has a specific capacitance that is significantly greater than all the other
 94 capacitors. An electrolytic capacitor is a polarized capacitor whose anode is a positive plate where an
 95 oxide layer is formed through electrochemical principles that limit the use of reverse voltage. Indeed,
 96 reverse voltage would cause a chemical reaction (the reduction of the oxide and a release of gaseous
 97 dihydrogen), destroying the dielectric at the anode, which would create on one hand a short circuit
 98 and on the other hand would generate the creation of a layer of dielectric at the cathode releasing

99 dihydrogen and strongly increasing the internal pressure leading to an explosion. In order to maintain
100 the stability of the oxide, the voltage on the positive terminal should always be higher than the voltage
101 on the negative terminal.

102 The electrical, thermal and mechanical constraints related to the use of these components are very
103 diverse. There are different types of capacitors that can cover all the needs of users. Three main types
104 of capacitors can cover all the needs of users. Generally, electrolytic capacitors contain aluminum,
105 tantalum or niobium [14]–[16]. In this article, a review of the operation and properties of the
106 electrolytic capacitor (Aluminum, Tantalum and Niobium) is presented. The paper also proposes a
107 review on maintenance to anticipate failures with non-intrusive diagnosis. In order to overcome these
108 problems and to be able to estimate the remaining lifetime with predictive maintenance, the
109 identification of failure mechanisms and modes is reviewed. Information on different methods and
110 algorithms based on the variation of aging indicators with constraints, which can lead to aging laws, is
111 provided. Finally, an overview of several significant methods existing in the literature is summarized,
112 based on failure prognosis.

113 1.2 Aluminum electrolytic capacitors

114 One of the major axes of research on electrolytic capacitors is the aluminum electrolytic capacitor
115 (AEC). They have higher volume efficiency due to a significantly lower minimum dielectric thickness
116 than all the other capacitors. However, they have a high internal resistance as well as an inductance
117 limiting high frequency performance and low temperature stability [17], [18].

118 Until the wound construction of aluminum foil capacitors, this type of capacitor was bulky and heavy.
119 There are different sizes of capacitor ranging from 3 mm in diameter for 5 mm in height up to 90 mm
120 for 210 mm [19]. Now, AEC became the model for all modern electrolytic capacitors due to their range
121 of voltage ratings and capacitances. This advantage is useful in power supply filters where they are the
122 most common component [15]. This type of capacitor offers high power density but has high leakage
123 current and high sensitivity to reverse polarity. It is necessary to use temperature sensors and current
124 limiters due to their risky failure mode. Indeed, in the event of a power surge there is a high risk of fire.
125 This type of capacitor has an operating temperature of up to 150°C in some cases, allowing a wide
126 range of operating temperatures. Moreover, compared to other electrolytic capacitors, they are less
127 expensive not only because of the materials used but also because of the manufacturing process. They
128 offer good stability and a long service life. In addition, the article indicates that today some
129 components have a theoretical life of about 15 years at 65°C compared to an estimated life of half a year
130 in the 1960s [20]. Aluminum electrolytic technology tends to be more and more reliable.

131 AEC consists of two aluminum electrodes, a film oxide layer (alumina) acting as a dielectric, and an
132 electrolyte which consists of a mixture of solvents and additives to meet given requirements. The main
133 electrical property of the electrolyte is its conductivity. In addition to good conductivity of the
134 operating electrolytes, other requirements include:

- 135 • chemical stability,
- 136 • high flash point/flammability point,
- 137 • chemical compatibility (e.g. with aluminum).

138 And in some cases, it may be interesting to have a low viscosity, a minimal negative impact on the
139 environment and a low cost. The electrolyte must, if possible, be able to carry out the formation and
140 self-repair processes of alumina, this will be detailed below. This is why there is a wide variety of
141 solutions for different requirements for the liquid electrolyte [21]. These chemical mixtures allow the

142 electrolyte to be a very good conductor over a wide range of temperatures. Three main groups of
143 "wet" electrolytes are used today:

- 144 • Electrolytes based on boric or benzoic acid dissolved in ethylene glycol or glycerin and water.
145 But in these electrolytes, an undesirable chemical reaction occurs between the crystal and the
146 water: the acid with the alcohol gives ester and water [22]. This constitutes the degradation of
147 the electrolyte. These "borax" electrolytes are standard electrolytes, which have long been
148 used for their low cost, and have a water content of between 5 and 20%. They operate at a
149 maximum temperature of 85 °C or 105 °C over the entire voltage range up to 500 V [23], [24].
- 150 • Anhydrous electrolytes based on organic solvents, such as dimethylformamide (DMF), γ -
151 butyrolactone (GBL) or dimethylacetamide (DMA). These capacitors with organic solvent
152 electrolytes are suitable for temperature ranges up to 150 °C, have low leakage current values
153 and age well. In order to have the best performance, it is recommended to use picric acid
154 (DMA) and a lactone-based solvent such as GBL, however this comes at a price. A second
155 possibility is to use DMF in order to keep good performances at a lower cost, although this
156 chemical is carcinogen and can be injurious to health [25]–[28].
- 157 • Water-based electrolytes with high water content, up to 70% water for low impedance, low
158 ESR or high ripple current electrolytic capacitors with voltage ratings up to 100 V for low cost
159 applications [29]. ESR and ripple current will be described below, in capacitors these
160 parameters are linked to internal heating. The corrosion potential of water on aluminum
161 should be avoided with appropriate additives [30].

162 Non-solid electrolytes can easily fit in the rough structure due to the liquid medium which has ion
163 conductivity due to the ions [31]. However, the electrolyte is not a perfect conductor like a metal: an
164 electrolytic capacitor has a non-negligible series resistance. In addition, there is an inductance effect
165 which is more important the higher the frequency. This is due to the overall volume of the capacitor,
166 and the more inductive connections than some types of film or ceramic capacitors. Originally, these
167 capacitors were not designed to be used for decoupling or filtering signals. AEC are mainly used in the
168 filtering part of power supply circuits [14].

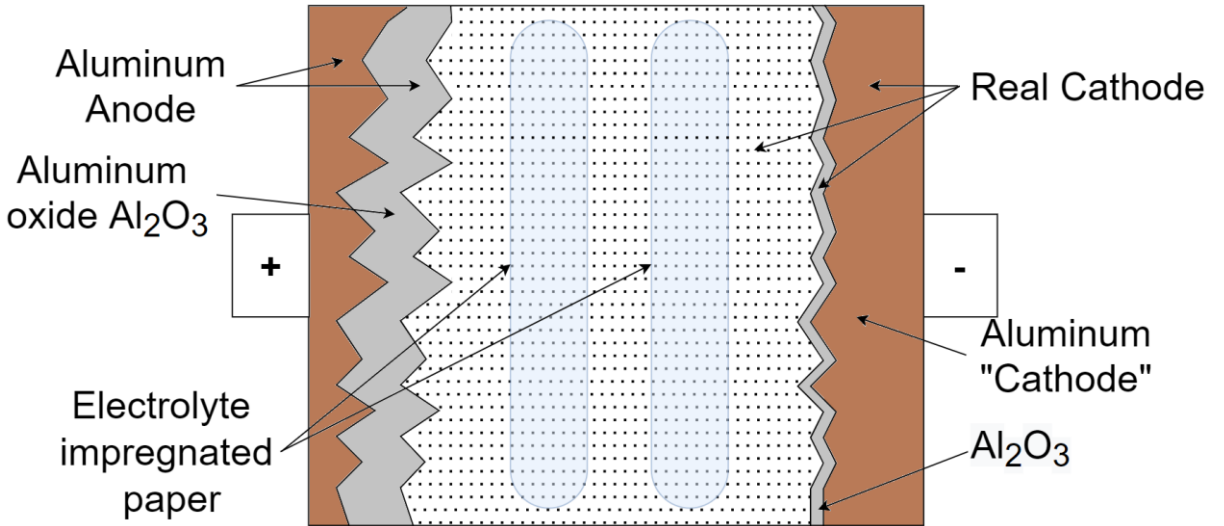

169
170 *Figure 3: Detailed diagram of the constitution of an AEC consisting of etched aluminum electrodes, an alumina dielectric and*
171 *an electrolyte support with sheets of paper impregnated with this electrolyte.*

172 In addition, the majority of AEC have an anode etch [32], as shown in **Figure 3**. Etching will increase
173 the surface area of the anode, and therefore the capacitance, by controlled deposition of the dielectric.
174 Etching is used to chemically remove layers from the surface, a portion of the surface is protected from

175 etchant by a mask material that resists etching, and then the mask is removed. For example, if the
 176 aluminum electrode is the material to be etched, then the etchants are phosphoric acid (H₃PO₄), water,
 177 acetic acid and nitric acid (HNO₃) [33]. It should be noted that the quality of the etching has an
 178 important influence on the capacitance of the capacitor and largely determines its tolerance. As it has
 179 been seen above, the thickness of the oxide layer (a few nm to a few hundred nm) and the etching of
 180 the aluminum foil constituting the anode (allowing the effective surface to be 20 to 200 times wider)
 181 allows important capacitance [19], [34]. The use of a liquid electrolyte will allow the exploitation of a
 182 specific surface area greater than a flat electrode surface. Indeed, the increase in surface area will
 183 allow a significant increase in capacitance. It is then understood that the AEC has an all the greater
 184 capacitance. A more detailed sketch of ACE is shown in **Figure 3**. In this figure, sheets of paper
 185 impregnated with electrolyte can be seen. Electrolyte impregnated paper serves as physical separator
 186 limiting the risk of short circuits between the two electrodes. The thin layer of Al₂O₃ (alumina) on the
 187 cathode is caused by natural oxidation of aluminum which limits corrosion as shown in **Figure 3**.
 188 However, the aluminum oxide layer present on the anode is caused during the construction of the
 189 capacitor by the application of a potential according to the equation below [20]:

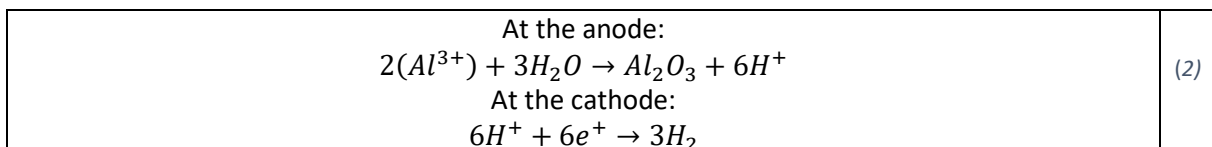

190

191 The electrolytic capacitors have a specific characteristic, a DC leakage current. This leakage current
 192 includes the imperfection of the dielectric due to chemical processes which happens during the storage
 193 time when there is no applied voltage. In order to dramatically reduce the leakage current of the
 194 capacitor, researchers found a way to reform the dielectric. When a voltage is applied to the capacitors,
 195 the same electrochemical reaction seen previously generates a natural oxidation of the aluminum. This
 196 same reaction takes place even with slight defects in the dielectric and regenerates the alumina oxide
 197 layer. The leakage current drops within the first minutes of voltage application, reflecting the repair
 198 phenomenon of the dielectric layer due to the oxidation reduction reactions (2). The time required for
 199 the leakage current to decrease generally depends on the type of electrolyte. For example, the leakage
 200 current of solid electrolytes drops much faster than for non-solid electrolytic capacitors, but it remains
 201 at a higher level. Non-solid electrolytic capacitors with highly concentrated water electrolytes, in the
 202 first minutes, generally have a higher leakage current than those with an organic electrolyte, but after
 203 several minutes they reach the same level. Once the dielectric layer has completely reformed, the
 204 leakage current tends to a stable nominal value. If the capacitors still do not meet the leakage current
 205 requirements after self-repair, this can be an indication of permanent damage. This phenomenon is
 206 called “self-healing” or “self-repair” and should not be mixed up with the self-healing of a metalized
 207 film capacitors [35], [36]. This occurs thanks to an electrochemical phenomenon of electrolysis of water
 208 transforming it into oxygen and hydrogen allowing the generation of alumina by the chemical formula
 209 above. Self-healing of the dielectric prevents the risk of electrical breakdown.

210 AEC that have been stored for long periods of time should go through a voltage treatment process that
 211 will reform the dielectric (Al₂O₃) through the electrolyte and bring the leakage current back to the
 212 original level. The increase in leakage current during storage varies with the holding voltage of a
 213 capacitor. In general, the higher the voltage rating, the greater the increase in leakage current tends
 214 to be. Also, since storage for a long period of time can reduce the life of capacitors, storage conditions
 215 should be considered in relation to the life requirements of the device. When an AEC is stored under
 216 no load conditions for a long period of time, the electrolyte may have degraded the oxide layer of the
 217 anode. Since the dielectric strength has been reduced by the electrolyte, the capacitor has a higher

218 leakage current than originally. The voltage applied to the capacitor will allow the oxide layer to
219 reform. This is why, many technical guides [17], [37] advise charging the capacitor to its nominal
220 voltage for one hour through a resistor to prevent the capacitor from overheating. Thus, the leakage
221 current returns to its initial value due to the reformation of the dielectric. It can be found in [38], for
222 an AEC stored a temperature between -5°C and $+50^{\circ}\text{C}$, we must reform the dielectric of the AEC by
223 applying a voltage. This voltage will be different depending on the storage time according to the
224 following criteria:

- 225 • For $U < 100\text{ V}$, the storage time is 5 years.
- 226 • For $100\text{ V} < U < 360\text{ V}$, the storage time is 3 years.
- 227 • For $360\text{ V} < U < 500\text{ V}$, the storage time is 1 years.
- 228 • For $U > 500\text{ V}$, the storage time is 6 months.

229 In this section, the various steps in the construction of an aluminum electrolytic capacitor are
230 described. There are several steps to build an AEC:

231 Etching: The anode foil is made of an almost pure aluminum foil, 40 to 110 μm thick. In order to
232 increase its effective surface area, the use of a direct or alternating current with a solution of chloride
233 can transform the smooth surface into a rough surface. Etching is performed on high-purity aluminum
234 foil by an electrochemical process in a chloride solution with either direct or alternating current. AC
235 electrolysis is generally used for low voltage capacitors, and DC electrolysis is used for medium and
236 high voltage capacitors. The multiplication factor is the ratio of the capacitance of the smooth surface
237 to the etched surface and, usually, it reaches values ranging from 10 to 100. Sometimes, in order to
238 enhance the exchange of the cathode with the electrolyte, the cathode foil, 20 to 50 μm thick, is also
239 etched (**Figure 4. 1**).

240 Formation: By electrolysis under a continuous voltage, higher than the nominal voltage, the
241 aluminum oxide layer is formed on the aluminum foil surface. The advantage of AEC is the ability to
242 change the thickness of the oxide film by changing the voltage (**Figure 4. 2**).

243 Slitting: According to the capacitance value and geometric dimensions desired, the formed
244 electrode foils are cut (**Figure 4. 3**).

245 Winding: The anode foil is wound up with the cathode sheet and the impregnated electrolytic
246 paper (separator) to form a cylinder. This paper serves to avoid short circuit and to maintain the
247 uniform thickness, density and absorption of the electrolyte. Connection strips distributed on the
248 winding are assembled (**Figure 4. 4**).

249 Impregnation: Impregnation is the process of saturating the winding with electrolyte to make sure
250 that there is a good contact between the oxide layer and the real cathode. With or without heat, the
251 mechanism of impregnation consists in the immersion of the winding with pressure and vacuum cycle
252 in the electrolyte. The electrolyte must adhere to the whole surface of the anode and cathode foils to
253 have a higher capacitance. It can also repair defects in the anode oxide film as seen before. The nature
254 of the electrolyte influences the temperature and frequency characteristics response of the capacitor
255 (**Figure 4. 5**).

256 Assembly: To avoid the deterioration from evaporation or moisture absorption of the electrolyte,
257 the winding needs to be inserted in a metal case and sealed-off. Finally, a safety valve is added which
258 allows the evacuation of a possible overpressure, in the event of evaporation of the electrolyte (**Figure**
259 **4. 6**).

260 Reforming: This process permits to repair the oxide film, that could have been broken during the
 261 assembly step, by applying a continuous voltage. This voltage needs to be superior to the forming
 262 voltage of oxide (**Figure 4. 7**).

263 Inspection: After the sealing, products are inspected for capacitance, leakage current, external
 264 appearance and performances as required before packaging.

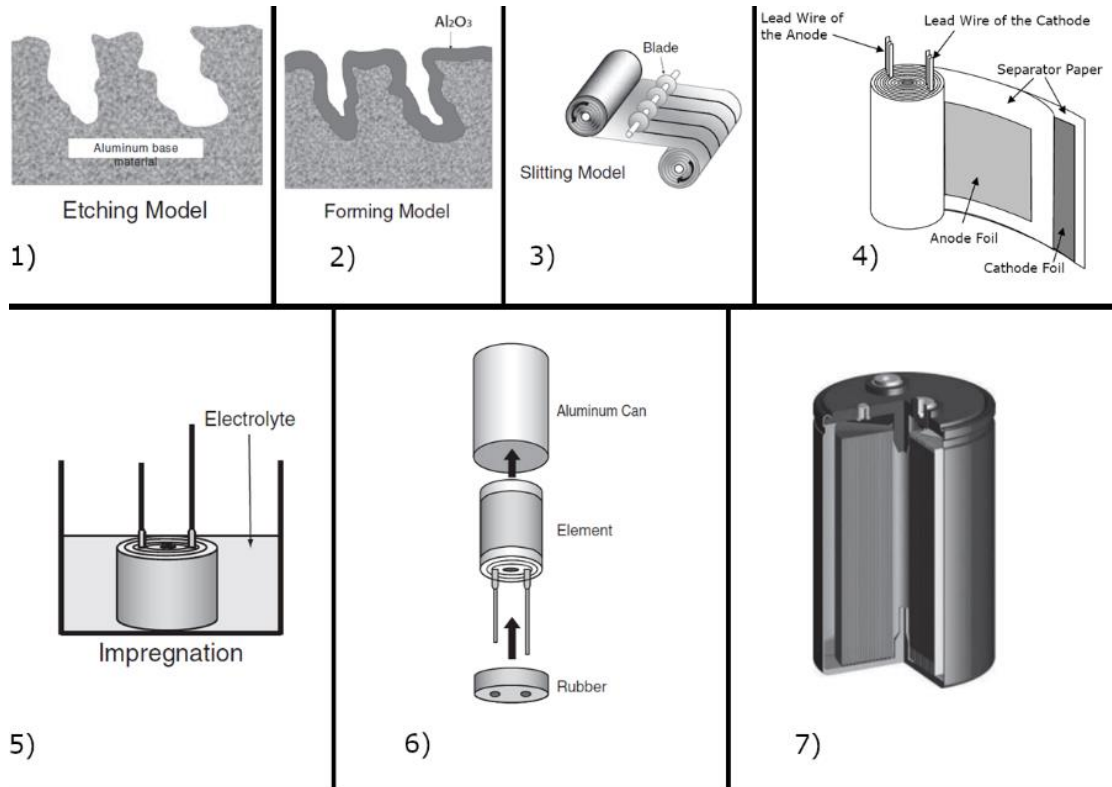

265
 266 *Figure 4: 1) Etching of an aluminum sheet. 2) Formation of oxide layer. 3) Slitting of the aluminum sheets. 4) Winding. 5) Impregnation. 6) Assembly. 7) Final Product. [39]–[41]*
 267

268 1.3 Types and features of electrolytic capacitors

269 Although the aluminum electrolytic capacitor has been the focus of research in recent years, it is not
 270 the only one. It can be interesting to classify the different electrolytic capacitors because each of them
 271 has preferential characteristics according to the applications and its environment.

272 1.3.1 Comparison of electrolytic capacitor types

273 Tantalum electrolytic capacitor:

274 There is a multitude of electrolytic capacitors such as tantalum that have better stability, a wider
 275 operating temperature range and a longer service life than others [42] but who are considerably more
 276 expensive. They consist of metallic tantalum which acts as an anode covered by an oxide layer of
 277 tantalum pentoxide (Ta_2O_5), surrounded by a conductive solid or liquid electrolyte which acts as the
 278 cathode. The dielectric, made of tantalum pentoxide, has a minimum thickness of 1.4 nm/V. Indeed,
 279 this type of capacitor generally has a larger capacitance value since it has a very thin dielectric layer
 280 with higher permittivity than aluminum capacitor (see **Table 2**). They are polarized, which means that
 281 electrolytic capacitors cannot be connected to an AC supply. Compared to many types of capacitors,
 282 they have excellent stability, high cut-off frequency characteristics and higher energy density [43].
 283 Their benefits include low impedance and low leakage current with high frequency performance [44].
 284 Initially, tantalum capacitors were low voltage and unreliable. The failure rate and the operating life of

285 tantalum capacitors have been improved nowadays due to the decrease in DC leakage current. The
286 article [45] shows a comparison between a tantalum polymer capacitor from the 1990s and one from
287 today. However, the risk associated with this kind of capacitors is their failure mode that generates
288 fires and explosions. Therefore, their use requires additional safety devices such as overvoltage
289 protection or reverse polarity protection.

290 In terms of applications, tantalum capacitors are widely used in laptops, the automotive industry and
291 mobile phones. In the past, tantalum capacitors were built with axial anode capacitors with liquid
292 electrolyte that made them heavy and expensive [16]. Now, they are widely used in power filters, by
293 pass channel circuit, for coupling and decoupling [46]. As SMD (Surface Mounted Devices), they take
294 up much less space on the PCB (Printed Circuit Board) and allow higher energy densities. They are
295 manufactured with capacitance values ranging from 100 nF to 10 mF and are smaller compared to
296 aluminum capacitors. The rated voltage can range from few volts to 100 V. They have a high ESR
297 (Equivalent Series Resistance) but that is still ten times smaller than the ESR of aluminum capacitors
298 [47]. Compared to AEC, high currents can be obtained without creating much heat. When handled
299 correctly, this type of capacitor can be stored for a long time due to its stability. Tantalum capacitor
300 manufacturers advise that tantalum capacitors should never be used in a circuit where a reverse
301 voltage may be applied, but indicate that tantalum capacitor have been shown to be capable of
302 withstanding momentary reverse voltage peaks of up to 10 % of the DC rating at 25°C [48]. Indeed,
303 researchers have obtained that leakage currents of a tantalum capacitor rapidly increase if the applied
304 reverse voltage exceeds 10% of the DC rating [49].

305 Niobium electrolytic capacitor:

306 Niobium electrolytic capacitors are made of passivated niobium metal or monoxide and a non-liquid
307 electrolyte (Polymer or MnO₂). The materials and processes used to produce niobium capacitors are
308 essentially the same as for tantalum capacitors which means they show similar chemical properties.
309 Electrochemical etching of niobium foil is possible in order to enlarge the surface area for the
310 application in electrolytic capacitors [50]. Niobium pentoxide has a greater dielectric constant than
311 tantalum pentoxide but a lower voltage, it allows to obtain the same amount of energy [15]. However,
312 the energy density is lower than the one of tantalum due to its large size. The maximum temperature
313 of operation is limited to 105°C, the leakage current is 5-10 times higher than for tantalum capacitors
314 [16]. Niobium can be found in abundance in the nature compared to tantalum and it is less expensive.
315 But the high melting point obstructed the industrial development of this one until 2000 when the price
316 increase for tantalum encouraged the development of niobium electrolytic capacitors with manganese
317 dioxide and polymer electrolyte [51].

318 Basic construction of Tantalum and Niobium electrolytic capacitors:

319 The positive terminal consists of tantalum or niobium powder pressed and sintered into a pellet. The
320 process of creating the powder takes place in a liquid phase at about 600°C under agitation. The
321 chemical process is [52]:



323 The reduction of sodium generates heavy tantalum or niobium particles that fall to the bottom of the
324 reactor while the potassium and sodium fluoride salts go to the surface. There is a mixture reduction
325 set (KCl, KF, NaCl, Na) that depends on the manufacturer. The powder is evaluated for its "CV/g", this
326 is the value of the capacitance multiplied by the voltage obtained per gram. These values depend on
327 conditions such as: press density range, anodizing voltage and sintering quality. The porosity of the
328 positive terminal is generally higher than 50% of the total volume [53]. The dielectric is formed by an

329 electrochemical process called anodization. It forms the insulating oxide layer that covers the anode
 330 over the tantalum particles [54]. As with other electrolytic capacitors, the thickness of the dielectric
 331 layer depends on the total applied voltage. The chemical equations are shown below:

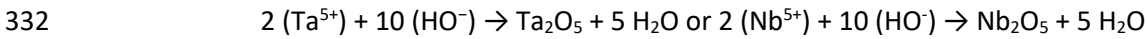

333 Immersed in an aqueous solution of manganese nitrate ($\text{Mn}(\text{NO}_3)_2$), followed by pyrolysis (at about
 334 250 °C) of the manganese nitrate into solid manganese dioxide and nitrogen oxide gas [55]. The
 335 manganese dioxide coats the dielectric surface inside and outside the porous anode while the nitrogen
 336 oxide gas evaporates from the capacitor body. The chemical equations are shown below:



338 The procedure is repeated until the pellet has a dense coating on the inner and outer surfaces. To
 339 ensure a solid connection, the pellet is dipped in graphite and silver. The final result is represented in
 340 **Figure 5** showing an illustration of a solid Niobium or Tantalum electrolytic capacitor.

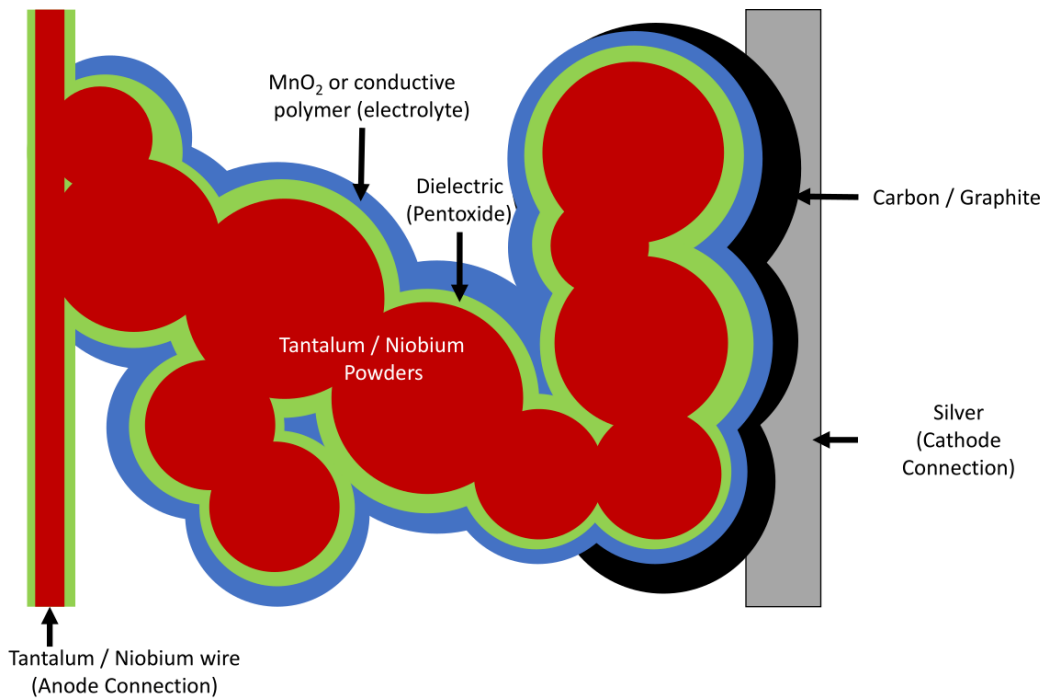

341
 342 *Figure 5: Sketch of the structure of a sintered tantalum or niobium electrolytic capacitor.*

343 Instead of graphite and silver, the tantalum polymer electrolytic capacitor uses a conductive polymer.
 344 For wet tantalum capacitors, the anode is immersed in a liquid electrolyte inside an enclosure after it
 345 has been sintered and a dielectric layer has been formed as for an aluminum electrolytic capacitor.
 346 Finally, the product is inspected and performance is tested to verify the specifications before being
 347 packaged.

348 **1.3.2 Comparison of electrolytic capacitor parameters**

349 Depending on the nature of the used anode metal and electrolyte, there is a wide variety of electrolytic
 350 capacitors. An overview of the main characteristics of the different types is listed in **Table 1** [56]–[60].

Dielectric	Electrolyte	Capacitance (μF)	Maximum temperature (°C)	Operating voltage (V)

Alumina oxide (Al₂O₃)	GBL, DMF, DMA	0.1 to 10 ⁶	150	550
	Borax, glycol	0.1 to 10 ⁶	105	630
	Water based	1 to 2x10 ⁴	105	100
	Solid, Polymer	10 to 2x10 ³	100	25
	Hybrid polymer solid and non-solid	6 to 10 ³	125	125
Tantalum oxide (Ta₂O₅)	Sulfuric acid	0.1 to 2.10 ⁴	200	650
	Solid, Manganese dioxide	0.1 to 3x10 ³	150	120
	Solid, Polymer	5 to 10 ³	125	10
Niobium oxide (Nb₂O₅)	Solid, Manganese dioxide	1 to 10 ³	125	10
	Solid, Polymer	5 to 500	125	16

351

Table 1: Operating properties of electrolytic capacitors

352 In order to compare these three main categories of capacitor and to sum up some characteristics of
 353 electrolytic capacitors, the different modern electrolytic capacitors present in the market along with
 354 their dielectric properties are listed in **Table 2** [58], [61].

Dielectric	Dielectric constant	Dielectric strength (kV/cm)	Electric layer thickness (nm/V)	Benefits	Drawbacks
Alumina oxide (Al₂O₃)	8 to 10	6600 to 7700	1.1 – 1.5	- Volume Ratio - Less expensive - Better range of Voltage and Capacitance	- High Leakage current - Risky failure mode
Tantalum oxide (Ta₂O₅)	10 to 27	6250 to 10 000	1.4	- Low impedance - Low Leakage current - High Frequency	- Risky failure mode
Niobium oxide (Nb₂O₅)	41	4000	2.5	-High dielectric constant - Good balance - Common materials	- Low capacitance per volume - Low Voltage

355

Table 2: Characteristics of electrolytic capacitors.

356 Although there are many electrolytic capacitors, they have some common characteristics. Electrolytic
 357 capacitors are the cheapest and most requested capacitors thanks to their high storage densities and

358 low rated currents. However, their ESR and ESL value limits their maximum operating frequency. Their
 359 low current and temperature management limitations restrict their integration in some applications,
 360 but recent work has been done in recent years to integrate electrolytic capacitor technology [25], [62].
 361 Electrolytic capacitors offer very high capacitance, but this type of capacitor has drawbacks such as
 362 high leakage current and high ESR. Some electrolytic capacitors may experience a gradual loss of
 363 capacitance when subjected to heat. Indeed, capacitors can suffer catastrophic failures when stressed
 364 beyond their rated capacity or when they reach the end of their normal life. By understanding the
 365 physical mechanisms that lead to capacitor failure, the life of the next generation of electrolytic
 366 capacitors can be improved. Therefore, the characteristics and failure modes in the rest of this article
 367 are presented.

368 2. Features and failure modes

369 In conversion systems, electrolytic capacitors, which ensure a stable DC network, are an important part
 370 of the electrical energy conversion chain. During operation, they are subject to electrical and
 371 environmental stresses (ambient temperature, current ripple, applied voltage, humidity, vibrations,
 372 etc.) and their lifetime is affected. In order to estimate the remaining life of electrolytic capacitor, a
 373 model that can characterize the system is presented in a first part. Thus, a low-cost maintenance
 374 operation such as predictive maintenance is detailed. Finally, the failure modes of electrolytic
 375 capacitors are studied since maintenance requires the use of failure indicators.

376 2.1 Series equivalent circuit model of a capacitor and characteristic

377 There are several equivalent circuits representing the frequency behavior of capacitors. The most used
 378 model combining simplicity and relatively good precision is shown in the following **Figure 6**:

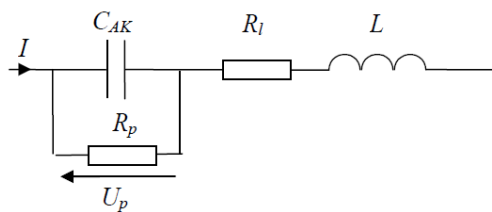

379
380 *Figure 6: Equivalent circuit of a capacitor [63].*

381 As stated in [39]:

- 382 • R_p : Resistance due to electrolyte and dielectric losses. This element represents the insulation
383 resistance of the capacitor that induces a leakage current.
- 384 • C_{AK} : Ideal capacitance between the cathode and the anode.
- 385 • L : Equivalent series inductance of connections and windings.
- 386 • R_l : Series resistance of connections, impregnated paper and electrodes.

387 More or less complex models of the capacitor can be found in the literature, but they are built for a
 388 specific environment [64]. this schematic can be simplified which yields to the normalized
 389 representation **Figure 7**. It is composed of elements depending on the frequency:

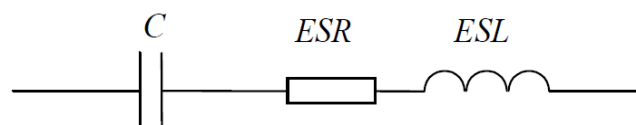

390
391 *Figure 7: Normalized equivalent circuit of a capacitor [63].*

- 392 • ESL: Equivalent series inductance.

- 393 • C: Equivalent capacitance.
- 394 • ESR: Series equivalent resistance representing all losses.

395 By identifying the impedances of the circuit, it is possible to deduce:

- 396 • $C = C_{AK} \left(1 + \frac{1}{R_p^2 C_{AK}^2 \omega^2} \right)$
- 397 • $ESR = R_l + \frac{R_p}{1 + R_p^2 C_{AK}^2 \omega^2}$
- 398 • $ESL = L$

399 This representation is important because it can be deduced from the characterization of the capacitor
 400 during the frequency measurements of the impedance. Indeed, the resistor ESR represents the real
 401 part of the impedance while the imaginary part is comparable to reactance $\frac{1}{C\omega}$ at low frequencies and
 402 $ESL\omega$ at high frequencies. The resonant frequency can be written as:

$f_r = \frac{1}{2\pi\sqrt{ESL \cdot C}}$	(3)
--	-----

403 Regarding the Equivalent Series Resistance (ESR), this is a characteristic representing the total ohmic
 404 losses of a capacitor. The current research consists in reducing the ESR because it leads to overheating
 405 and to a decrease of the filtering performances. The ESR in an electrolytic capacitor is mainly due to
 406 the finite conductivity of the electrolyte. The ESR is connected to the dielectric losses (P_d) and losses
 407 created by Joule Heating:

$P = P_d + R_l I^2 = ESR \cdot I_r^2$	(4)
---------------------------------------	-----

408 With I_r : Ripple Current value

409 Ripple current results in increased dissipation in parasitic resistive portions of circuits like the ESR of
 410 capacitors. This information can lead to a thermal analysis [65], [66]. The self-heating due to the power
 411 loss of a capacitor where it depends on the ESR, the ripple current and the thermal resistance between
 412 the package and the environment can be considered. The maximum power that a capacitor can
 413 dissipate without degradation depends on its thermal dissipation properties (size of the component,
 414 materials, geometry, condition of use...). If thermal radiation and thermal conduction are neglected, it
 415 can be found that the self-heating can be expressed as:

$\Delta T = \frac{ESR \cdot I_r^2}{hS}$	(5)
---	-----

416 With h : Thermal convection coefficient and S : the external surface of heat exchange between the
 417 capacitor and the ambient air.

418 Heat generation affects the lifetime of the capacitor, as it will be seen below, by evaporation of
 419 electrolytes. If the dimensions of the capacitor are known, the maximum ripple current value can be
 420 deduced from the maximum specified temperature. The lower the ESR, the higher the ripple current
 421 and the better the functionality of the capacitor. There are various studies on the thermal behavior of
 422 capacitors [67]–[69] but this will not be detailed in this paper.

423 The larger the ESR decrease of a capacitor, the more the efficiency can be improved. Near the
 424 resonance, the impedance is close to the ESR. Therefore, the ESR is a factor that limits the filtering
 425 performance of the capacitor. In addition, the ESR is proportional to the heating caused by the losses
 426 by the Joules effect. Therefore, in order to decrease voltage fluctuations, low ESR values are needed.

427 For high current circuit uses, designers should obtain capacitors with a minimum ESR [70] in order to
428 maintain power levels.

429 The Dissipation Factor (DF) which is given by the manufacturer:

$DF = \tan \delta = ESR \cdot C \cdot \omega$	(6)
---	-----

430 The Dissipation Factor allows to determine the total losses P in the component according to the total
431 reactive power Q:

$P = \tan \delta \frac{I^2}{C\omega} = Q \cdot \tan \delta$	(7)
---	-----

432 2.2 Maintenance

433 There is an electrical model of the capacitor in which the usual properties (Losses, Joule heating, DF...)
434 are defined by parameters such as ESR, ESL, C. By studying the evolution of some parameters such as
435 the ESR and the capacitance under different operating conditions (temperature, voltage, frequency...),
436 the evolution of the mode of operation and the degradation state of the capacitor can be determined.
437 In order to improve the reliability and availability of industrial equipment by reducing the number of
438 breakdowns, with a non-intrusive diagnosis, there are three types of maintenance:

439 1) Preventive maintenance is a maintenance carried out at predetermined intervals without
440 considering the instantaneous conditions of the use of the machine [71]. Waiting for failure can be a
441 costly strategy because failure of capacitors can lead to accidents which can cause financial loss and
442 damage.

443 2) Corrective maintenance is a strategy based on the idea that the costs sustained for breakdown and
444 repair are lower than the investment required for a maintenance program. Indeed, the maintenance
445 is realized after the detection of an anomaly and normal operating conditions have to be restored [72].

446 3) Predictive maintenance detects the appearance of aging or progressive failure in order to anticipate
447 breakdowns. To make a non-destructive or non-intrusive diagnosis, it is necessary to set up a periodic
448 monitoring of parameters on the equipment in operation. It uses sensor data to monitor a system and
449 then evaluates it to predict failure before it occurs. Thanks to that the reliability and availability of
450 industrial equipment can be improved by reducing the number of breakdowns. It also reduces the cost
451 of preventive maintenance by providing the best time to change parts, neither too early (preventive
452 maintenance) and neither too late (maintenance corrective) [73]. In order to apply conditional
453 preventive maintenance, it is necessary to identify the causes, mechanisms and modes that govern
454 capacitor failures. Then, it is necessary to select aging indicators that reflect the wear of the component
455 associated with these failures. Thanks to the evolution of aging indicators, it is possible to establish
456 aging models. Based on these aging models, the estimation of the remaining useful life and the health
457 status of the component can be performed.

458 In order to be able to apply predictive maintenance (summarized in **Figure 8**) it is necessary to identify
459 the causes, mechanisms and modes that govern capacitor failures. By knowing the characteristics of
460 the capacitors (state of the art or datasheet) and their evolution over time according to the different
461 constraints applied (temperature, current and voltage), it is then possible to estimate the aging
462 indicators.

463 Hence, there are different methods that can detect in real time the evolution of the ESR and the
464 capacitance C in order to realize a system of monitoring and predictive maintenance of electrolytic
465 capacitors [63], [74], [75]. To do so, it is necessary to create a method that can identify in real time

466 aging indicators of any capacitors and then to create an algorithm. This algorithm needs to be able to
 467 build a model of aging in real time and to deduce the remaining life of the capacitors, due to the
 468 estimations of the ESR and C. There are also other methods and algorithms to determine the ESR and
 469 C of the electrolytic capacitor [76]–[78]. But they are expensive to use due to the many measurements
 470 and computations required. Indeed, The aging models based on offline method [63], [78] require
 471 accelerated aging tests which takes time for each new version of the capacitor.

472 Based on this diagnostic and prognostic work, optimizations can be performed. A selection of the
 473 potential failure mechanism is necessary to reduce the number of indicators used in aging models.
 474 These models are used to estimate the remaining life and to monitor the health of the capacitors. Once
 475 the aging model can be built and optimized, the model can be extrapolated into the future in order to
 476 have an estimate of the remaining lifetime (and consequently the health status) of the capacitor.

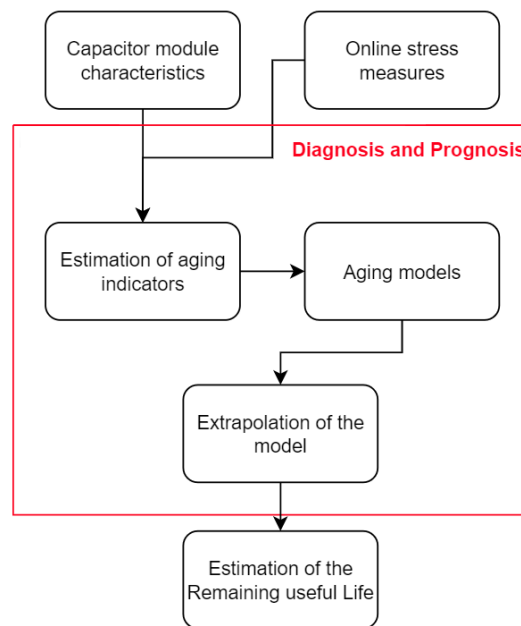

477

478

Figure 8: Electrolytic capacitor failure prognosis method diagram.

479 Electrolytic capacitors are known to be sensitive to temperature and frequency variations. In fact, an
 480 electrolytic capacitor has several modes and causes of failure. The main reason for temperature
 481 dependence is due to the electrolyte and for the frequency it is due to the dielectric oxide [79]. This
 482 frequency effect can be seen in the ripple current multipliers provided by capacitor manufacturers
 483 [41]. It is due to energy losses in the temporal variation of the alignment of dipoles. It becomes even
 484 more significant for capacitors with a thicker oxide layer. Regarding the increase in the temperature
 485 of the capacitor, this one decreases the resistivities of the system. An increase in temperature also
 486 increases the effective area of the electrode due to thermal expansion and results in an increase in C
 487 and decrease in ESR with a temperature increase as it can be seen in [77], [80]. If the temperature
 488 increases enough, the electrolyte can evaporate and the main mechanism of failure is the evaporation
 489 of the electrolyte due to the ripple currents. This leads to an increase of the equivalent series resistance
 490 (ESR) which increases the losses and, then, the temperature. This rise of temperature accelerates the
 491 mechanism of evaporation and so on [79]. As the electrolyte solution dries up, the amount of
 492 electrolyte decreases and the effective contact area between electrodes decreases. This results in a
 493 decrease of the capacitance [78] and an increase in ESR which accelerates the degradation process and
 494 can cause damage. The properties of the electrolyte constituting much of this resistance are the cause.

495 At low temperatures, a phenomenon of electrolyte thickening [81] induces less mobility of ions and
 496 leads to an increase in ESR.

497 All of electrolytic capacitors are frequency and temperature sensitive [82], have a fairly short lifespan
 498 and have a fairly high failure rate [83]. There are many studies on the failure modes of electrolytic
 499 capacitors, and mainly aluminum electrolytic capacitors. Indeed, from the understanding of the
 500 mechanisms and failure modes of a capacitor, it is possible to apply a maintenance in order to know
 501 the remaining lifetime of the component.

502 2.3 Mechanisms and failure modes

503 2.3.1 Non-solid electrolytic capacitor failure modes

504 As it has been seen in this paper, the capacitance and the ESR depend on the temperature, frequency
 505 and voltage. There is a lot of papers concerning the thermal influence [83]–[88], the current influence
 506 [56], [83]–[85], [87], [88], voltage influence [85], [88], [89] on these characteristics of the capacitor. A
 507 charge/discharge influence can be seen in some studies [85], [89], where excessive charging and
 508 discharging cycles at high currents will accelerate the degradation of the oxide shower and increase
 509 the leakage current. Here, the current being important in the capacitor at the time of the discharge, it
 510 will prevent the auto-regeneration of the layer of alumina oxide and thus increase the leakage current
 511 [90]. Indeed, there are many failure origins that can lead to various failure modes in electrolytic

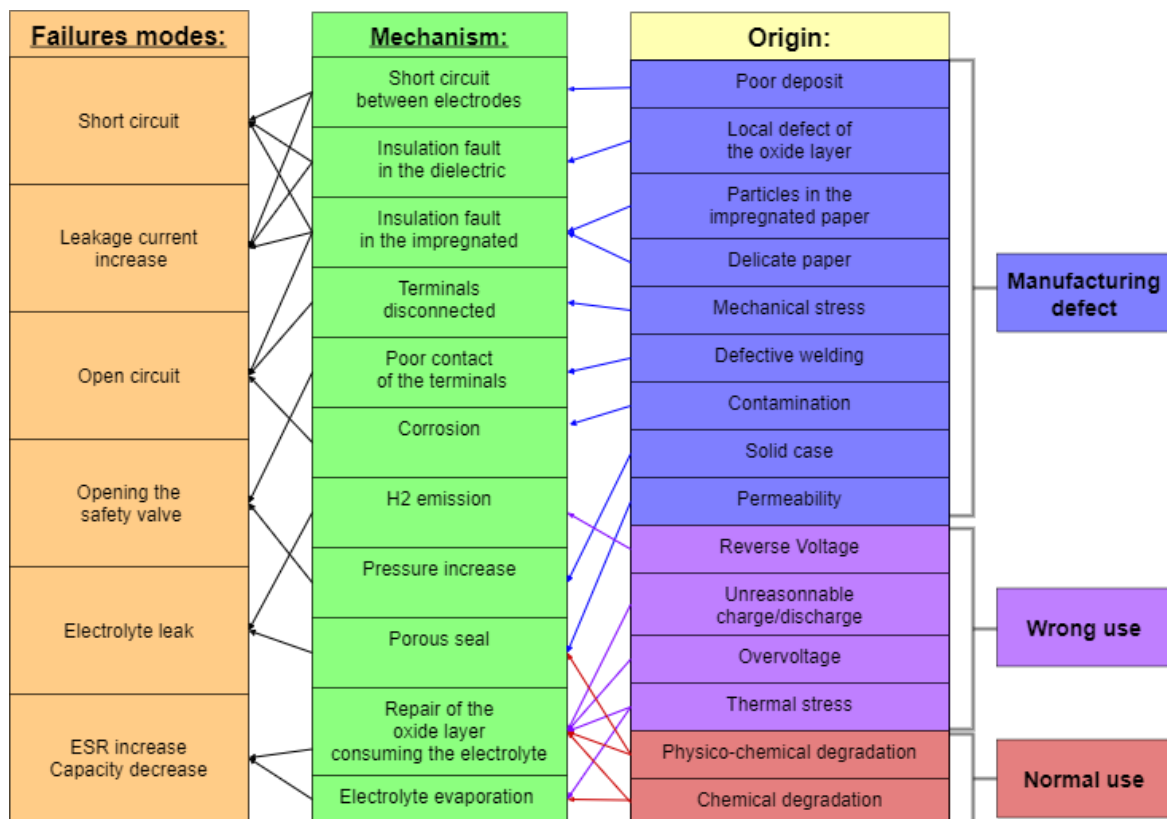

512 capacitors. Evaporation of the electrolyte creates an overpressure inside the component. It can be
 513 assumed that the rate of electrolyte loss is directly proportional to the vapor pressure of the
 514 electrolyte. Ref. [79] gives element to connect the core temperature to the vapor pressure of the
 515 electrolyte, which is mainly ethylene glycol. These elements are used to characterize the quality of the

Figure 9: Mechanisms and failure modes according to the stress in an electrolytic capacitor.

516 end seal. The more the evaporation progresses, the greater the overpressure becomes and, beyond a

517 certain threshold, it can cause an explosion. An increase in the leakage current of the various
 518 components has been observed during aging. This phenomenon is due to a degradation of the
 519 dielectric. A degradation of the oxide layer facilitates the appearance of dielectric breakdown which
 520 can short-circuit the capacitor. Indeed, the oxide layer (dielectric) determines the voltage withstand
 521 (see **Table 2**). The leakage current in capacitors depends on the dielectric characteristics. Its density
 522 must be homogeneous over the whole surface of the electrodes in order to obtain the lowest possible
 523 leakage current. However, the self-healing phenomenon generates hydrogen ions (2) which will react
 524 with the electrons supplied by the cathode to create gaseous dihydrogen. This dihydrogen will increase
 525 the internal pressure of the system and is a flammable and reactive gas.

526 **Figure 9** summarizes the impact of the different stresses on the capacitor. The causes are generally
 527 related to manufacturing defects, wrong use or aging of the component. It appears that the prediction
 528 of failure of these components other than that due to wear can only be statistical given the many
 529 causes of failure leading to various failure modes. Therefore, in this case, the increase of the ESR and
 530 the decrease of C are aging modes that occur after applied stress. Indeed, a thermal stress that can
 531 cause the evaporation of the electrolyte or the rise of the pressure can generate the increase of the
 532 ESR and the decrease of the capacitance. Similarly, a voltage stress that can degrade the oxide film of
 533 the anode or cathode can also generate an increase in ESR, a decrease in capacitance and an increase
 534 in leakage current. According to **Figure 9**, it would not be possible from the leakage current to estimate
 535 the health status of the component since the origin of the failure is due to a manufacturing defect.
 536 Indeed, it is difficult to quantify this parameter by online methods. In addition, according to certain
 537 aging tests, this current has a stable then violent evolution when a fault appears. Therefore, the
 538 leakage current will not be considered as an indicator of failure and aging, unlike ESR and C, although
 539 there is some work on this subject [91], [92].

540 A normal use of the capacitor leads to the evaporation of the electrolyte and the repair of the oxide
 541 layer. These are two causes of electrolyte disappearance, which is the main cause of capacitor
 542 degradation under normal conditions. Voltage and temperature, even without exceeding the limit
 543 values (wrong use), are important contributing factors to aging. An aging indicator is a parameter which
 544 can quantify and monitor the overall aging of a capacitor. However, the ESR and the capacitance C are
 545 two electrical parameters making it possible to monitor the degree of degradation of an electrolytic
 546 capacitor. This is why these two parameters are considered as indicators of aging. The moments when
 547 the aging indicators reach their limit value set by the user or by the standard correspond to the end-
 548 of-life of the capacitor. The end of life of an electrolytic capacitor under thermal and electrical
 549 constraints is defined by a 20% decrease in capacitance or a 100% increase in ESR [93]–[96]. Common
 550 lifetime specifications derived from endurance tests at 85, 105, and 125°C are shown in **Figure 10**. In
 551 this figure, the variation of capacitance and impedance with respect to its origin during aging tests
 552 under different temperatures is shown. As it is presented below, temperature is an aging factor for
 553 capacitors.

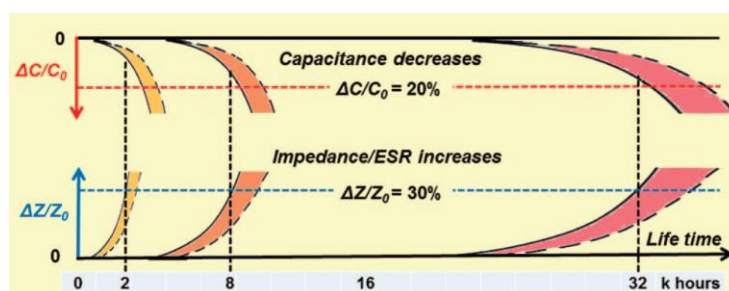

554
 555 *Figure 10: Endurance tests under 85°C (red), 105°C (orange), 125°C (yellow) of an AEC [19].*

556 Concerning other non-liquid electrolytic capacitors, as there is no liquid electrolyte such as in the
557 niobium or tantalum capacitor, the phenomena of wear related to electrochemical reactions cannot
558 take place. However, it is possible to use manufacturers' recommendations to extend the life of this
559 type of component. Polymer, solid tantalum, and solid niobium electrolytic capacitors also have a
560 lifetime specification. However, they do not have a lifetime specification in the non-solid AEC sense.
561 The many types of electrolytic capacitors exhibit different electrical aging behaviors and intrinsic
562 failure modes. In order to ensure long life and high reliability of the electrolytic capacitor, some
563 application rules are detailed below for each electrolytic capacitor.
564

565 2.3.2 Solid and polymer electrolytic capacitor failure modes

- 566 • Polymer Tantalum and Niobium capacitor

567 Solid polymer tantalum electrolytic capacitors do have a life time specification. Indeed, the polymer
568 electrolyte has a slight deterioration of conductivity by a thermal degradation mechanism of the
569 conductive polymer. The electrical conductivity decreases, as a function of time, in agreement with a
570 granular metal type structure, in which aging is due to the shrinking of the conductive polymer grains
571 [97]. The main advantage of polymer electrolytic capacitors over wet electrolytic and MnO_2 capacitors
572 is their low temperature dependence coupled with their non-ignition failure mode. These capacitors
573 can avoid ignition because the conductive polymer cathode does not contain active oxygen that could
574 ignite the tantalum anode. The no-ignition failure mode is an important safety feature, especially in
575 low ESR circuits. Concerning the self-healing of polymer-based capacitors, they have a polymer playing
576 the role of an electrolyte. There is also the phenomenon of self-healing for this type of electrolytic
577 capacitor. As seen previously, the leakage current will generate a rise in temperature. This will allow
578 the vaporization of the polymer present in contact with the dielectric and the inhibiting of the
579 conductive contact of the defects. Or the leakage current will generate an oxidation of the polymer
580 increasing then the resistivity and limiting/blocking the leakage current. In both cases, the reduction
581 of the contact area causes a decrease of the capacitance.

- 582 • Solid Tantalum and Niobium capacitor

583 The typical failure mode of solid MnO_2 tantalum and niobium capacitors is a short circuit, and in some
584 cases the failed capacitors ignite. The tantalum/niobium capacitor structure uses an extremely thin,
585 glass-like material for its dielectric. Throughout the process, foreign matter can enter the structure.
586 The soaking and drying process introduces multiple thermal exposures. Combined with the huge
587 surface area of the electrolytic capacitor, this leads to the formation of defects in the capacitor
588 structure. This is because when a large amount of stored energy is rapidly released through a small
589 break channel, micro-cracks or pores [98] in the dielectric, it causes a rapid increase in temperature
590 and release of oxygen from the MnO_2 cathode. Ignition is an important phenomenon to keep in mind.
591 It occurs if the resistivity of the defective dielectric is too low and when the leakage current which is
592 too high and overrides the self-healing phenomenon. For solid niobium capacitors, when the main
593 dielectric is broken, the capacitor goes to high resistance, typically about 34 k Ω [99]. Indeed, at 450°C
594 the transformation of MnO_2 into Mn_2O_3 is not instantaneous. This is why it is necessary to have a
595 leakage current that is not too high for the MnO_2 to heat up and transform, otherwise there is a risk of
596 deterioration of the Ta_2O_5 / Nb_2O_5 and ignition in the fault. Nevertheless, a possibility of ignition in the
597 event of failure as well as a high ESR compared to the ESR of ceramic and film capacitors with metal
598 electrodes have limited the military applications of tantalum and niobium solid capacitors [100].

599 Aging is a process that activates the self-healing mechanism of the MnO_2 to remove defect sites from
600 the capacitor structure. It happens when the application of an electric field generates a current through
601 a defect site and causes a breakdown of the dielectric as well as the appearance of higher currents. At

602 the fault site, there is a concentration of current in the MnO₂ adjacent to the fault. This current causes
 603 local heating of the MnO₂ at the fault current entry point. When the MnO₂ heats up to 500°C [98], it
 604 transforms into a less oxygenated state, Mn₂O₃. The more conductive manganese oxide combination
 605 is MnO₂, and the reduction in oxygen content results in an increase in ESR. This conversion thus limits
 606 the current in the fault site and decreases the contact area thereby reduces the capacitance. These
 607 conversions are permanent, sealing these fault sites for the rest of the life of the capacitor.

- 608 • Derating voltage for Niobium and Tantalum capacitors

609 Tantalum and niobium capacitors are as reliable as other electronic components, with very low failure
 610 rates. However, they have a unique failure mode called "field crystallization". Field crystallization
 611 occurs only at certain sites on the metal-oxide interface that are favorable for the formation of
 612 crystalline nuclei. These sites can be areas with high impurity content in the metal. Field crystallization
 613 is a main reason for the degradation and catastrophic failures of solid niobium and tantalum capacitors.
 614 By reducing the maximum operating voltage from the rated voltage, the risk of failure as well as the
 615 risk of potential ignition is reduced. Indeed, it is recommended by the manufacturers of tantalum and
 616 niobium capacitors to reduce voltage by 50% and 20% respectively for temperatures below 85°C [55].
 617 There is a correlation between the time to failure and the conditions according to [102]. The effect of
 618 voltage derating can be estimated from the following empirical component dependent equation:

$\frac{t_1}{t_2} = \left(\frac{V_2}{V_1}\right)^n \exp\left(\frac{E_a}{KT}\left(\frac{1}{T_1} - \frac{1}{T_2}\right)\right)$	(8)
--	-----

619 where: t_1 and t_2 stand for the time to failure under condition 1 and 2, V_1 and V_2 for the voltage 1 and
 620 2, T_1 and T_2 for absolute temperature 1 and 2, n for the voltage stress exponential, E_a for the activation
 621 energy for dielectric wear out and k_B is the Boltzmann constant.

622 The parameters n and E_a in this equation are typically determined from the distribution of failure time
 623 data in accelerated tests with several voltage combinations. The large surface area of tantalum or
 624 niobium pentoxide impurity sites exist in all capacitors. To minimize the possibility of providing enough
 625 activation energy to convert these impurity sites from an amorphous to a crystalline state that will
 626 conduct energy, it is recommended to use derating. By reducing the electric field inside the anode at
 627 these sites, the reliability of the tantalum or niobium capacitor can be greatly increased [103].

628 The knowledge of the physical mechanisms degrading the state of health of a component has allowed
 629 the establishment of empirical law to relate the life of the component according to certain constraints.
 630 Just like derating in the case of tantalum and niobium capacitors, there are also laws linking the life of
 631 a component and the aging indicators for non-solid electrolytic capacitors.

632 3. Aging process of non-solid electrolytic capacitors

633 It has been seen that normal use leads to the evaporation of the electrolyte and the repair of the oxide
 634 layer. These are two causes of electrolyte disappearance, which is therefore the essential cause of
 635 capacitor degradation under normal conditions. The physical consequences are: increase of ESR and
 636 decrease of C. These two parameters are therefore essential both to measure the health of capacitors,
 637 but also to build aging models. The objective in this chapter will be to determine the health of a non-
 638 solid electrolytic capacitor from physical measurements of ESR and C.

639 3.1 Characterization of aging indicators of electrolytic capacitors

640 It is important to have models of the variation of ESR and C as a function of influencing factors other
 641 than aging, if they are for use as an aging indicator for predictive maintenance.

642 The properties of the electrolyte constituting much of this resistance are the cause. For example at low
 643 temperatures, the electrolyte is thick, induces less mobility of ions and leads to an increase in ESR [81].
 644 The variation of ESR as a function of temperature can be approximately expressed by an exponential
 645 law of the form [104]:

$ESR(T) = \alpha + \beta \cdot e^{-\frac{T}{\gamma}}$	(9)
---	-----

646 With: γ , β , α component dependent coefficients.

647 To have an accurate model, it can be, for example, adjusted by the least-squares method to fit the ESR
 648 drift for one type of capacitor. Levenberg Marquardt's non-linear least squares method allows a fine
 649 approximation of the model. However, there are more accurate models to describe the evolution of
 650 ESR as a function of temperature and time, detailed below.

651 In [74], the method presented consists in parameterizing laws directly from datasheets provided by
 652 the manufacturers, without having to perform experimental tests for each capacitor. These evolution
 653 laws are self-parameterized by the implemented aging algorithm monitoring the aging indicators in
 654 real time and thus making it possible to determine the time before the failure of the capacitors used
 655 in the considered converters.

656 In order to facilitate the understanding of the physical principles involved in the capacitor and to
 657 confirm theoretical models, it is interesting to perform characterizations. These characterizations will
 658 make it possible to obtain macroscopic data and to highlight the influence of this data according to
 659 certain parameters (voltage, temperature, frequency...) on the ESR and C. Throughout the
 660 characterization of the capacitor, it will be essential to perform a metric characterization. This consists
 661 of recording dimensions and weight for later comparison in the event that testing degrades the sample.
 662 For example, the evaporation of the electrolyte can modify the structure, the weight and the behavior
 663 of the capacitor under test.

664 • Frequency Characterization:

665 Offline characterizations can be performed, the interest is to define some parameters before the aging
 666 of the capacitor. Using an impedance analyzer, it is possible to inject a sinusoidal signal of low
 667 amplitude under continuous bias in order to study the modulus and phase of the response. This
 668 characterization will give the evolution of the impedance as a function of frequency. In **Figure 11**, the
 669 modulus of impedance as a function of frequency is represented. The characteristics of the capacitors
 670 are clearly divided into two areas. At low frequencies (f_l), capacitors behave mainly capacitively and
 671 their imaginary parts can be likened to $\frac{-1}{c\omega}$ reactance. However, with increasing frequency, the
 672 inductive effect grows on the rest of the parameters until it dominates the behavior of these
 673 components. In this case, the reactance of the capacitors is assimilated to $L\omega$ at high frequencies f_h .
 674 The real part represents all the losses in the component, and is identified with the resonance frequency
 675 where the total impedance Z of the capacitors is equivalent to its resistive part. The latter gives a global
 676 view of the variation of the losses in the component, but does not allow to study the individual
 677 evolution of the parameters (R_l and R_p from **Figure 6**) with respect to the applied constraints. This is
 678 how the capacitance, the ESR and the ESL are defined:

$C = \frac{1}{2 \cdot \pi \cdot f \cdot Z(f_l)}; ESR = Z(f_r); ESL = \frac{Z(f)}{2 \cdot \pi \cdot f_h}$	(10)
--	------

679 With: f_l a low frequency; f_r the resonant frequency; f_h a high frequency

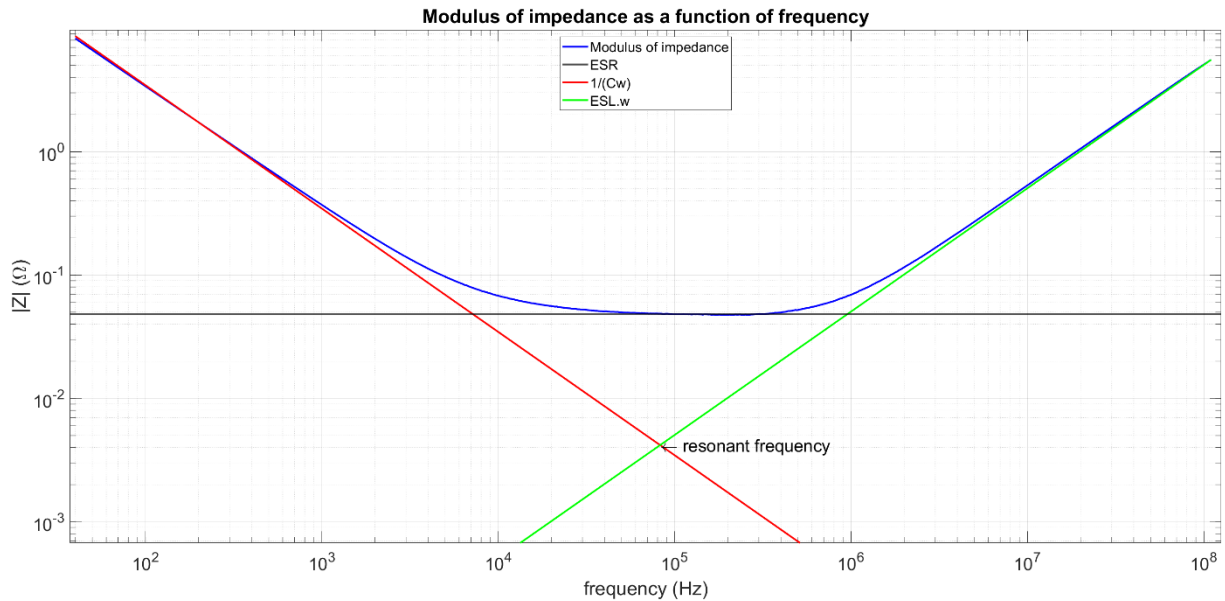

680

681 *Figure 11: Bode diagram for an aluminum electrolytic capacitor (470 μ F / 50 V) with: $ESL = 8.05 \cdot 10^{-9}$ H and $ESR = 48.2$ m Ω .*

682 A complementary characterization to the proposed frequency characterization is possible. This
 683 consists of placing the capacitor under test in a climatic chamber and performing the same procedure
 684 in order to obtain several evolutions of the impedance as a function of frequency for different
 685 temperature values. Indeed, the state of life of a capacitor or the temperature can modify the behavior
 686 of the capacitor and thus the frequency response. As it has been seen, ESR and C depend on the
 687 temperature. The use of an environmental chamber is then required in order to get accurate values.

688 Characterizations under different voltages will allow us to study the dependence of the electrical
 689 quantities, previously identified, according to the DC voltage. An impedance analyzer can be used for
 690 the frequency characterization of components. In addition, an experimental model can be made to
 691 reach nominal voltages of several hundred volts if necessary while protecting the impedance meter.
 692 However, this configuration can limit the study frequency range.

693

- Temporal Characterization:

694 In this type of characterization, the interest is to be able to perform online measurements. Using the
 695 measurements previously made, it is then possible to define an equivalent model. The analyzer will
 696 give the values of the identified electrical parameters by considering a final model of the capacitor
 697 under test. Thus, the values of the capacitance C, the ESR and the ESL can be drawn. For example, the
 698 equivalent RLC schematic (**Figure 6**) is, at first, a good approximation. However, depending on whether
 699 it is placed before or after the resonance frequency, or whether there is more or less precision, this
 700 scheme can evolve later.

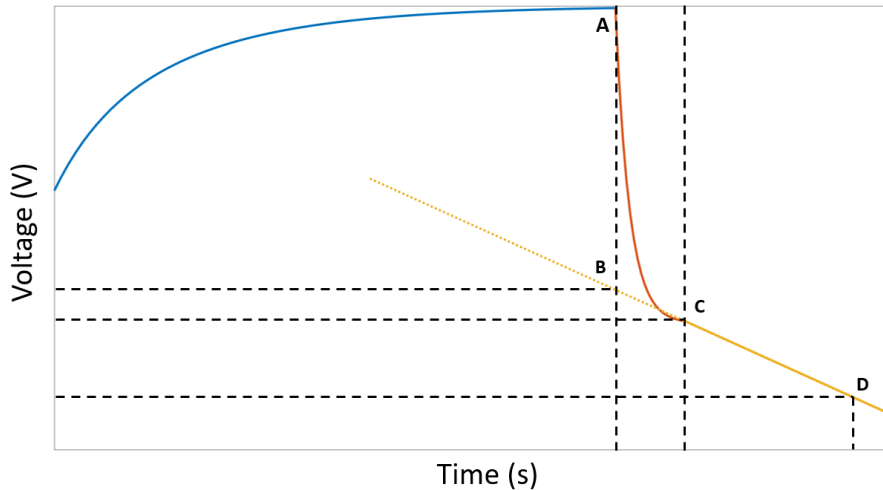

701

702

703

Figure 12: Diagram of the variation of the voltage of a capacitor during a charge and discharge. Blue curve: charging voltage. Orange curve: transient discharge. Yellow curve: constant discharge.

704

705

706

707

708

709

710

It is possible to determine the capacitance and the ESR of a capacitor under test thanks to a temporal characterization. The capacitor is charged using a DC voltage. Then, a discharge is carried out by measuring the variation of the voltage perceived by the capacitor. Graphically in **Figure 12**, four important points can be obtained. The voltage at the moment of discharge (A), two points (C and D) during the discharge and the point (B) obtained by the intersection between the moment of discharge and the extension of the linear regression line of the curve related to the decrease of the voltage during the discharge. One can obtain:

$C = I \cdot \frac{t(D) - t(C)}{V(C) - V(D)} \text{ and } ESR = \frac{V(A) - V(B)}{I}$	(11)
--	------

711

712

713

714

Thus, all these experiments of the complete cell will allow to characterize the aging indicator. It is then possible to carry out the aging of the studied capacitor and to compare these precise results with the aging models in order to better understand the degradation of the latter.

715

3.2 Aging models for electrolytic capacitors

716

717

718

719

720

721

Accelerated aging tests applied to components aim to reveal their failure mechanisms in order to assess their reliability and useful life in a relatively short time. The main constraint to consider for electronic components is temperature because it has a major influence on their failure rate. The temperature of the component to be considered is a function of the ambient temperature and the power dissipation in the component. But the chemical reaction rate constant is dependent on the absolute temperature T which is given by the Arrhenius equation:

$k_T = A \cdot e^{\left(-\frac{E_a T}{k_B}\right)}$	(12)
---	------

722

723

where: k_T is the rate constant; T is the absolute temperature; A is a pre-factor; E_a is the activation energy for the reaction.

724

725

726

727

728

729

The main effect of this type of aging is the evaporation of the electrolyte. Since this aging is comparable to a chemical reaction, Arrhenius' law can be used. It has been found that the activation energy (E_a) is of the order of 0.4 eV for AEC ([83], [105]) and 1.2 eV for tantalum capacitors [100]. The degradation rate of a capacitor is proportional to this exponential, whereas, the time of appearance of the failure t is inversely proportional to it. In order to determine the lifetime of electrolytic capacitors, the Arrhenius life-stress model can be used. It is the most common life-stress relationship utilized when

730 the acceleration stress is temperature [75], [106]–[108]. To estimate the lifetime at the temperature
 731 T , the following equation can be used:

$$K_{T \text{ Arrhenius}} = \frac{t}{t_0} = \frac{v_0}{v} = e^{\left(\frac{E_a}{k_B} \left(\frac{1}{T_0} - \frac{1}{T}\right)\right)} \quad (13)$$

732 where: t is the time of appearance of failure; t_0 is the specified lifetime given by the individual
 733 datasheets of products; T_0 is the specified temperature; v is the reaction speed according to the
 734 expected conditions of use; v_0 is the reaction rate under extreme conditions operation; $K_{T \text{ Arrhenius}}$
 735 is the temperature multiplying factor.

736 This law is interesting but it only involves temperature. Therefore, other aging laws involving several
 737 constraints exist. It gives a good approximation of the service life of a component, but it is limited to
 738 the effect of temperature alone. This estimate also depends on the range of the extrapolation (of the
 739 temperature); the values of life being all the more precise as the difference between the two
 740 temperatures is weak. It is possible to give an example in which the following aging equivalences have
 741 been obtained for an aging at 85°C extrapolated to 25°C: 2 years at 25°C is equivalent to 620h at 85°C
 742 and 5 years at 25°C is equivalent to 3115h at 85°C.

743 A second most common life-stress relationship is the general Eyring model [18], [109], [110]. Eyring's
 744 model improves Arrhenius's law because it can consider other constraints than temperature (humidity,
 745 voltage...). But, the downside of this model is the large number of parameters to identify. On the other
 746 hand, in a very large number of cases, this model can be simplified by considering some zero
 747 coefficients. So, the relationship of the time of appearance of failure can be found:

$$t_{Eyring} = A \cdot T^n \cdot e^{\left(\frac{E_a}{T k_B} + S_1 \left(B + \frac{C}{T}\right) + S_2 \left(D + \frac{E}{T}\right)\right)} \quad (14)$$

748 Where A, B, C, D, E, T and n are coefficients depending on the test and the failure with S_1, S_2 the
 749 constraints 1 and 2.

750 The prediction of capacitor life is mainly based on empirical models based on failure physics. The most
 751 commonly used model for electrolytic capacitors is based on Arrhenius' law, which describes the
 752 influence of the constraints related to the ambient temperature and the current flowing through the
 753 capacitors, and on the Coffin-Manson empirical law for the consideration of the applied voltage.
 754 Capacitor manufacturers offer, in their catalogs, a formula to estimate the lifespan of capacitors (L)
 755 according to the various constraints [18], [87], [111]:

$$L = L_0 \cdot K_T \cdot K_I \cdot K_V \quad (15)$$

756 with: L_0 is the specified life (hours) under extreme operating conditions (maximum allowable
 757 temperature, maximum allowable current ripple, rated voltage); K_T is the temperature factor; K_I is
 758 the ripple current factor; K_V is the voltage factor;

$$K_T = 2^{\frac{\theta_0 - \theta_x}{10}}$$

$$K_I = K_r \left(1 - \left(\frac{I_{RMSx}}{I_{RMS0}}\right)^2\right)^{\frac{\Delta\theta_0}{10}}$$

$$K_V = \left(\frac{V_0}{V_x}\right)^n \quad (16)$$

759 where: K_r is an empirical factor; θ_0 is the maximum temperature; θ_x is the ambient temperature; $\Delta\theta_0$
 760 is the rise in internal temperature due to the rated RMS current; V_0 is the rated voltage; V_x is the actual

761 operating voltage; $I_{I_{RMSx}}$ is the operating RMS current flowing in the capacitor; I_{RMS0} is the rated RMS
 762 current of the capacitor; n is an empirical constant of security.

763 Where K_r is an empirical safety factor [99], [100]:

- 764 • $K_r = 2$ if $I_{RMSx} \leq I_{RMS0}$
- 765 • $K_r = 4$ if $I_{RMSx} > I_{RMS0}$ (lifetime is divided by 4)

766 The exponent n can vary between 1 and 6 although for most suppliers [87], [113], the exponent is fixed
 767 by the following conditions [100]:

768
$$0.5 \leq \frac{V_0}{V_x} \leq 0.8 \rightarrow n = 3$$

769
$$0.8 < \frac{V_0}{V_x} \leq 1 \rightarrow n = 5$$

770 For small electrolytic capacitors, the lifetime is governed mainly by the temperature (consumption of
 771 the electrolyte) so the voltage factor K_V is estimated at 1 [18]. For every 10 °C increase in operating
 772 temperature, the life of the electrolytic capacitor reduces by half [113], [114]. But, there is a
 773 temperature range where the theory of lifetime is not applicable. Indeed, for a temperature higher
 774 than 100 °C, the temperature acceleration factor is different. Depending on temperature ranges of the
 775 lifetime estimation, the temperature acceleration factor needs to be modified [114].

776 In the literature, different models slightly modified can be found. Indeed, Gualous and Gallay [115]
 777 gave a model where they assumed that the supercapacitor life is proportional to the inverse reaction
 778 rate and proposed a modified Arrhenius equation. Dehbi and Wondrak [59] modified the temperature
 779 factor (**14**) to account for the applied voltage. And then, Jánó and Pitica [116] proposed a model taking
 780 into account the [115] [59] models. Cycling has an impact on the degradation of a supercapacitor and
 781 therefore on its lifetime. Using temperature, voltage and current for accelerated cycling tests, [117]
 782 this paper proposes a method to quantify the acceleration of aging during a cycling phase and a new
 783 equation to estimate the lifetime in order to integrate the influence of the RMS current.

784 Capacitance depends mainly on the condition of the dielectric in aluminum electrolytic capacitors.
 785 Indeed, the capacitance depends on the quality of the etching and the actual surface of the dielectric.
 786 Moreover, the phenomenon of self-healing of the dielectric has an influence on the quality of the
 787 dielectric and consequently on the capacitance. A linear model of the evolution of capacitance C as a
 788 function of aging time represents well the experimental evolutions of capacitance shown [68]:

$C(t) = \alpha_1 + \alpha_2 \cdot t$	(17)
--------------------------------------	------

789 With: α_1, α_2 the time evolution coefficients of C depending on the component.

790 The ESR primarily depends on the resistivity of the electrolyte in AEC. The variation in this resistance
 791 over time depends on the electrolyte and the aging temperature. A linear model of the evolution as a
 792 function of the aging time of the inverse ESR has been developed by Rhoades and Smith [118]. This
 793 linear model, model 1, in reverse was designed by Cathey and Joyner [119]. It provides a prediction of
 794 the evolution of the ESR as a function of aging time and temperature. The proposed relationship is as
 795 follows:

$\frac{1}{ESR(t_x)} = \frac{1}{ESR(t=0)} (1 - A_0 t_x e^{-\frac{Ea}{k_B T_x}})$	(18)
---	------

796 With: t_x the aging time at temperature T_x ; $ESR(t_x)$ the value of ESR at t_x ; $ESR(0)$ the value of ESR at
 797 $t = 0$; A_0 a constant depending on the component; E_a the activation energy of an AEC.

798 The activation energy (E_a) is of the order of 0.4 eV for AEC and this value is usually written as E the
 799 activation energy per Boltzmann's constant equals 4700 K [83], [105]. Although the model respects
 800 that the ESR is always positive and increases with aging, one can notice that in this model, the function
 801 giving the value of the ESR is not defined at all points. Indeed if $A_0 t_x e^{-\frac{E_a}{T_x}}$ tends to be equal to 1 then
 802 the ESR tends towards infinity. Therefore, one of the signs of failure is the rise of the ESR which is faster
 803 towards the end of the capacitor's life. There are also other assumptions on the variation of the ESR as
 804 a function of temperature and time. Indeed, in [90], they supposed different models, here is an
 805 example:

$ESR_1(t_x) = (ESR(t = 0) + A_1). e^{C_1 \cdot t_x}$	(19)
--	------

806 Where: $A_1 C_1$ is a constant depending on the component.

807 From the particular equation of the ESR (19) and using the law of Arrhenius (13), one can thus find the
 808 evolution of the ESR according to the time and the temperature of aging:

$ESR_2(t', T') = (ESR(t = 0, T') + A_1). e^{C_1 \cdot t' \cdot e^{\frac{4700 \cdot (T' - T_v)}{(T_v + 273) \cdot (T' + 273)}}$	(20)
--	------

809 With: t' the aging time at temperature T' ; T_v the aging temperature accelerated; T' the aging
 810 temperature extrapolated; $ESR(t', T')$ the value of ESR at t' at T' ; $ESR(0, T')$ the value of ESR at $t = 0$
 811 at T' .

812 The value of $ESR(t=0)$ at a temperature T' is obtained by the equation (19) giving the variation of ESR
 813 as a function of temperature. The rate of the chemical reaction leading to the degradation of ESR
 814 depends on the aging temperature of the component [84]. Indeed, this dependence is expressed by
 815 the relation (13) which makes it possible to obtain an aging time t' at temperature T' from
 816 measurements made during another aging of time t_v and temperature T_v .

817 An example of the rise of the ESR during time is shown in **Figure 13** where the experimental values of
 818 the ESR are measured at 66 kHz and 25 °C and the temperature of the capacitor is being kept at 105
 819 °C during the aging. The capacitors used in this study are aluminum electrolytic capacitors used in a
 820 dc/dc forward type converter to filter the output voltage. As it has been seen, the rise of the ESR
 821 increases more rapidly toward the end of the life of the capacitor. The evolution of the ESR follows a
 822 linear inverse ESR model versus time [104], [120], [121]. As it has been shown before, the
 823 determination of this model is necessary to predict the lifetime of the capacitor online.

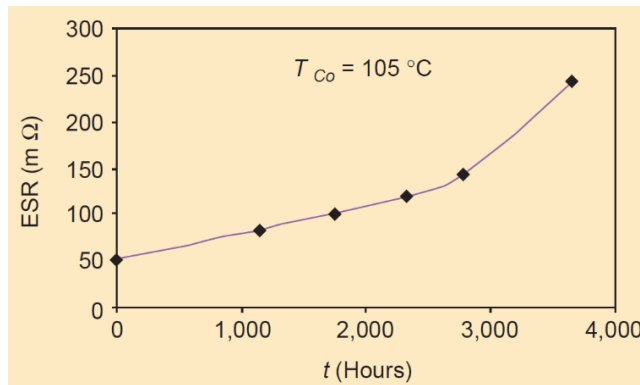

Figure 13: ESR versus aging test of electrolytic capacitors at $T=105^\circ\text{C}$ [104].

824
825

826 3.3 Detect the aging of non-solid electrolytic capacitors

827 There are several methods existing, in the literature, in order to detect the electrolytic capacitor aging.
828 In practice, they require accelerated aging tests and these methods can be grouped in different
829 categories depending on the type of stress applied.

830 A first type of stress used in most cases is the temperature using the Arrhenius equation. Temperature
831 is considered as the main constraint to be considered for electronic components because it has a major
832 influence on their failure rate. The temperature to consider is the temperature at the heart of the
833 component, which is a function of the ambient temperature and its heating created by dissipation. In
834 [84], a life model of AEC that is based on the mechanism of electrolyte vaporization and loss through
835 the seal has been developed. This physical failure model makes it possible to calculate the lifetime of
836 capacitors as a function of temperature using Arrhenius' law. The model incorporates relationships for
837 ESR change with electrolyte loss, ESR change with temperature, and heat transfer value using
838 temperature stress. These results are then compared with the lifetimes obtained using a law used in
839 industry which gives substantially more liberal predictions. Indeed, this method of detecting the aging
840 of electrolytic capacitors is quite accurate and allows the agreement between the prediction and the
841 experiment as in [104]. The method predicts the life of an electrolytic capacitor by estimating the
842 current state ESR and comparing it to its new condition with temperature constraint. The ESR, defined
843 by the ratio of the voltage ripple by the ripple current, is compared to the $ESR_{theoretical}$. Test results mostly
844 agree with the prediction and the mean difference is less than 10 %. It is also possible to quote [63],
845 [122] where the remaining life is estimated by subtracting the operating life obtained by regression
846 equations from the total life by using temperature stress. Indeed, this operating life is obtained using
847 regression (the least square fitting method) equations characterizing the temporal variations of the
848 capacitance C and of the ESR as a function of temperature. And from the Arrhenius equation for a fixed
849 temperature of the capacitor, the total lifetime can be deduced. The method used is to measure the
850 current and ripple voltage of the capacitors using cheap and simple analog circuits. This same method
851 can be seen in [123], it allows to obtain the operating lifetime of a capacitor by regression equations.
852 In this paper, a combined experimental and numerical approach, using multi-physics modeling
853 techniques to extract relevant physical parameters, at the component level, is proposed for lifetime
854 prediction using temperature stress. A degradation modeling approach is proposed in which the
855 parameters of the regression equations characterizing the capacitance and the ESR over time follow
856 Arrhenius' law. Increased current ripple in capacitors is considered a criterion for failure. Time to failure
857 can be calculated under variable temperature operating conditions.

858 It is possible to observe methods that include the impact of voltage in addition to using temperature
859 as a stress. Temperature is considered a major constraint, but it is not the only one. Some works try to
860 prove that it is not the majority compared to tension. In fact, many works deal with aging tests using
861 temperature and voltage as a type of stress. There is therefore a second type of stress, that is
862 temperature used with voltage. In [116], [124], it has been decided that current prediction algorithms
863 are not accurate enough to precisely estimate lifetime for AEC. Consequently, prediction methods are
864 combined (using voltage and temperature constraint) in order to give a higher accuracy lifetime
865 prediction algorithm. A new method of predicting the life of capacitors is introduced. The service life
866 obtained is more precise than the previous models because the capacitors are affected by the applied
867 voltages. Another work [18] shows the ESR and capacitance as aging indicators and major factors
868 influencing the lifetime of electrolytic capacitors used in power converters. In order to know the shape
869 of aging laws, accelerated aging tests are done in this work to assess the effects of thermal and
870 electrical overstresses through time. Early results show that a cubic regression has the best fit with the
871 experimental aging data.

872 The combination of temperature and current as a type of stress is presented in [125]. It is a new
873 method which predicts the life of an electrolytic capacitor by estimating the ESR and the ripple current
874 flowing through the capacitor using temperature and current as a constraint. A life model employing
875 core temperature estimation derived from ESR deterioration and operating conditions is shown.

876 As seen previously, the voltage can influence the aging of the capacitors by applying a voltage
877 overstress in order to subject the capacitor to continuous charge and discharge cycles. The purpose of
878 this experiment is to study the effect of high voltage stress on degradation of the capacitor in [126].
879 Using voltage stress, a methodology to predicting the remaining useful life for electrolytic capacitors
880 based on a Kalman filter is presented. It focuses on condition-based health assessment by estimating
881 the current state of health. In addition, this type of aging can be applied to tantalum electrolytic
882 capacitors as shown in [127] where a substantial number of samples have been life-tested under
883 voltage stress at temperatures from 25°C to 85°C.

884 Finally, a last category of stress is the one under nominal condition, which means below the operating
885 temperature and voltage. In [105], under nominal condition, the drift of ESR with time is determined
886 by the Arrhenius model. A third-degree regression model is proposed for the degradation of the mean
887 capacitance as a function of time. This type of stress under nominal condition can be seen in [128], this
888 work tries to determine all the evolution laws versus temperature, frequency and operation time. To
889 do so, the components are under nominal voltage at the maximum operating temperature allowed
890 with the use of a climate chamber. Then, the capacitors internal parameter behavior can be analyzed
891 against operating time and determine the aging laws of parameters as ESR and C of AEC.

892 There are disadvantages to these methods, it is necessary to have models of degradation of the
893 capacitors in real time considering the operating conditions (ambient temperature, voltage,
894 frequency...) to predict the lifetime of the capacitors. In addition, physical models and models of
895 degradation based on data regression are then combined. But these regression-based models require
896 large sets of samples to increase estimation precision. These different methods all use accelerated
897 aging tests. These methods constitute an essential learning phase, to be carried out offline, before any
898 online evaluation of the life of the capacitors. It is important to note that the accelerated aging tests
899 are carried out with each new version of the capacitor before it is integrated into the model. This is
900 why this method is costly in terms of time and money, which makes this step not very viable at the
901 industrial level. It would be interesting to design a strategy that uses the least amount of offline
902 resources. This strategy will not only improve the fit of the model, but also the prediction of health
903 status. In [74] the invention relates to a method for determining a value representative of the
904 remaining useful life (RUL) of a capacitor, based on specific values such as a maximum temperature
905 value and a maximum voltage value of the capacitor. The method is in two parts. The first one consists
906 in identifying in real time indicators of aging ESR and C of any capacitors integrated in a power
907 converter. The second phase is the implementation of an algorithm capable of constructing, thanks to
908 the estimations of ESR and C, a model of aging in real time and capable of deducing the remaining life
909 of the capacitors. As discussed, the offline learning phase where accelerated aging tests are performed
910 is a costly and time-consuming method. This invention is relevant because it allows an online
911 evaluation of the capacitor lifetime without performing an offline learning phase.

912 4. Conclusion

913 In this paper, a review of operation and properties of electrolytic capacitors is presented. A focus has
914 been done on the respective characteristics of three different types of electrolytic capacitors
915 (Aluminum, Tantalum and Niobium), the series equivalent circuit model of an electrolytic capacitor
916 and some information that can be deduced. The paper also proposed a review on predictive

917 maintenance in order to anticipate breakdowns with a non-intrusive diagnosis, neither too early as the
918 preventive maintenance nor too late as the corrective maintenance. In order to overcome these
919 problems and to be able to estimate the remaining life with the predictive maintenance, it is necessary
920 to identify the mechanisms and failure mode to limited the number of aging indicators. Different
921 methods and algorithm based on the variation of aging indicators as a function of constraint that can
922 lead to aging laws are proposed. Finally, an overview of several significant methods existing in
923 literature is presented, based on failure prognosis.

924 In order to predict the trend of electrolytic capacitors, one can imagine a hybrid electrolytic capacitor,
925 a technology that would combine the advantages of electrolytic capacitors such as high electrode
926 surface (pressed and sintered, porous, ...) with a composite hybrid dielectric structure to achieve
927 greater specific energy [129]. Carbon nanostructures can help to reach higher capacitance density than
928 the use of porous electrode [130]. Therefore, future developments will certainly always focus on
929 optimizing existing electrode materials and creating new materials with energy densities close to those
930 of batteries [131].

931 References

- 932 [1] E. Wolfgang, "Examples for failures in power electronics systems," *ECPE Tutorial on Reliability of*
933 *Power Electronic Systems*, 2007.
- 934 [2] S. Yang, A. Bryant, P. Mawby, Dawei Xiang, Li Ran, and P. Tavner, "An Industry-Based Survey of
935 Reliability in Power Electronic Converters," *IEEE Transactions on Industry Applications*, 2011, doi:
936 10.1109/TIA.2011.2124436.
- 937 [3] H. Wang *et al.*, "Transitioning to Physics-of-Failure as a Reliability Driver in Power Electronics,"
938 *IEEE Journal of Emerging and Selected Topics in Power Electronics*, 2014, doi:
939 10.1109/JESTPE.2013.2290282.
- 940 [4] U.-M. Choi, F. Blaabjerg, and K.-B. Lee, "Study and Handling Methods of Power IGBT Module
941 Failures in Power Electronic Converter Systems," *IEEE Transactions on Power Electronics*, 2015,
942 doi: 10.1109/TPEL.2014.2373390.
- 943 [5] D. Ton and W. Bower, "Summary Report on the DOE High-tech inverter workshop," *US Department*
944 *of Energy*, 2005. Accessed: Nov. 01, 2022. [Online]. Available:
945 https://www1.eere.energy.gov/solar/pdfs/inverter_II_workshop.pdf
- 946 [6] H. Wang, Y. Yang, and H. Sangwongwanich, "Design for Reliability of Power Electronic Systems,"
947 *Power electronics handbook. Butterworth-Heinemann*, 2018, doi: 10.1109/IECON.2012.6388833.
- 948 [7] M. E. Orazem and B. Tribollet, *Electrochemical impedance spectroscopy*. The Electrochemical
949 Society series. Wiley, 2008.
- 950 [8] B. E. Conway, "Chapter 12 : Capacitance Behavior of films of conducting, electrochemically
951 reactive polymers," in *Electrochemical Supercapacitors Scientific Fundamentals and Technological*
952 *Applications*, Springer, 1999.
- 953 [9] J. R. Miller, D. A. Evans, and E. Company, "Properties and performance of hybrid aluminum
954 electrolytic / electrochemical capacitors," presented at the CARTS conference. Components
955 Technology Institute, 1996.
- 956 [10] Nichicon corporation, "Conductive Polymer Hybrid Aluminum Electrolytic Capacitors." Datasheet.
957 Accessed: Nov. 01, 2022. [Online]. Available:
958 https://www.nichicon.co.jp/english/products/pdf_x/e-gya.pdf
- 959 [11] K. Nogami, K. Sakamoto, T. Hayakawa, and M. Kakimoto, "The effects of hyperbranched
960 poly(siloxysilane)s on conductive polymer aluminum solid electrolytic capacitors," *Journal of*
961 *Power Sources*, 2007, doi: 10.1016/j.jpowsour.2007.01.030.
- 962 [12] E. Manla, G. Mandic, and A. Nasiri, "Development of an Electrical Model for Lithium-Ion
963 Ultracapacitors," *IEEE Journal of Emerging and Selected Topics in Power Electronics*, 2015, doi:
964 10.1109/JESTPE.2014.2383955.

- 965 [13] D. S. Campbell, "Electrolytic Capacitors," *Components and Circuits Group Symposium on Capacitors*
966 *held in London*, 1970.
- 967 [14] J. Both, "Electrolytic capacitors, 1890 to 1925: early history and basic principle," *IEEE Electrical*
968 *Insulation Magazine*, 2015, doi: 10.1109/MEI.2015.6996675.
- 969 [15] J. Ho and R. T. Jow, "Historical Introduction to Capacitor Technology," *IEEE Electrical Insulation*
970 *Magazine*, 2010, doi: 10.1109/MEI.2010.5383924.
- 971 [16] J. Both, "Electrolytic capacitors from the postwar period to the present," *IEEE Electrical Insulation*
972 *Magazine*, 2016, doi: 10.1109/MEI.2016.7414227.
- 973 [17] Nichicon corporation, "General Descriptions of Aluminum Electrolytic Capacitors, Technical
974 Notes." 2015. Accessed: Nov. 01, 2022. [Online]. Available:
975 <https://www.nichicon.co.jp/english/products/pdf/aluminum.pdf>
- 976 [18] A. E. Hayek, P. Venet, R. Mitova, M.-X. Wang, G. Clerc, and A. Sari, "Aging laws of electrolytic
977 capacitors," p. 14, 2018.
- 978 [19] J. Both, "The modern era of aluminum electrolytic capacitors," *IEEE Electrical Insulation Magazine*,
979 2015, doi: 10.1109/MEI.2015.7126071.
- 980 [20] R. S. Alwitt and R. G. Hills, "The Chemistry of Failure of Aluminum Electrolytic," *IEEE Transactions*
981 *on Parts, Materials and Packaging*, 1965, doi: 10.1109/TPMP.1965.1135396.
- 982 [21] P. McKnight Deeley and The FaradNet Staff, "Part 3 Chapter 10 : Non-Aqueous Electrolytes and
983 Their Characteristics," Accessed: Nov. 01, 2022. [Online]. Available:
984 [https://web.archive.org/web/20160617163728/http://www.faradnet.com/deeley/chapt_10.ht](https://web.archive.org/web/20160617163728/http://www.faradnet.com/deeley/chapt_10.htm#index)
985 [m#index](https://web.archive.org/web/20160617163728/http://www.faradnet.com/deeley/chapt_10.htm#index)
- 986 [22] A. Berduque, Z. Dou, and R. Xu, "Electrochemical Studies for Aluminium Electrolytic Capacitor
987 Applications: Corrosion Analysis of Aluminium in Ethylene Glycol-Based Electrolytes," *CARTS-*
988 *Europe Virtual Conference.*, 2009.
- 989 [23] H. O. Siegmund, "The Aluminum Electrolytic Condenser," *Bell System Technical Journal*, 1929, doi:
990 10.1002/j.1538-7305.1929.tb02305.x.
- 991 [24] J. L. Stevens, J. S. Shaffer, and J. T. Vandenharn, "The service life of large aluminum electrolytic
992 capacitors: effects of construction and application," *IEEE Transactions on Industry Applications*,
993 2002, doi: 10.1109/TIA.2002.802922.
- 994 [25] Z. Dou and R. Xu, "Development of Electrolytes in Aluminium Electrolytic Capacitors for
995 Automotive and High Temperature Applications," *Conference Proceedings*, 2008.
- 996 [26] K. N. Borba, F. Trombetta, R. F. de Souza, and E. M. A. Martini, "Stability of Al₂O₃/Al in ionic liquid
997 BMI.BF₄/γ-butyrolactone electrolytes for use in electrolytic capacitors," *Ionics*, 2017, doi:
998 10.1007/s11581-016-1912-x.
- 999 [27] J. Barthel, H.-J. Gores, G. Schmeer, and R. Wachter, "Non-aqueous electrolyte solutions in
1000 chemistry and modern technology," in *Physical and Inorganic Chemistry*, Springer Berlin
1001 Heidelberg, 1983. doi: 10.1007/3-540-12065-3_2.
- 1002 [28] J. D. Dale-Lace, "Capacitors for power supplies," *Electronics and Power*, 1986, doi:
1003 10.1049/ep.1986.0146.
- 1004 [29] D. Petrov and U. Hilleringmann, "Water-based primary cell for powering of wireless sensors," in
1005 *IEEE SENSORS*, 2020. doi: 10.1109/SENSORS47125.2020.9278891.
- 1006 [30] J. Menzel, E. Frackowiak, and K. Fic, "Electrochemical capacitor with water-based electrolyte
1007 operating at wide temperature range," *Journal of Power Sources*, 2019, doi:
1008 10.1016/j.jpowsour.2018.12.080.
- 1009 [31] J. H. Masliyah and S. Bhattacharjee, *Electrokinetic and colloid transport phenomena*. Wiley-
1010 Interscience, 2006.
- 1011 [32] H.-J. Butt, K. Graf, and M. Kappl, *Physics and chemistry of interfaces*. Physics textbook: Wiley-VCH,
1012 2003.
- 1013 [33] S. Wolf and R. N. Tauber, "Silicon Processing for the VLSI Era: Process Technology." Process
1014 Technology, 1999.

- 1015 [34] D. G. W. Goad and H. Uchi, "Modelling the capacitance of d.c. etched aluminium electrolytic
1016 capacitor foil," *Journal of applied electrochemistry*, 2000, doi: [https://doi.org/10.1007/s10854-](https://doi.org/10.1007/s10854-015-3280-0)
1017 015-3280-0.
- 1018 [35] M. Makdessi, A. Sari, and P. Venet, "Improved model of metalized film capacitors," *IEEE*
1019 *Transactions on Dielectrics and Electrical Insulation*, 2014, doi: 10.1109/TDEI.2013.004158.
- 1020 [36] O. G. Gnonhoue, A. Velazquez-Salazar, É. David, and I. Preda, "Review of Technologies and
1021 Materials Used in High-Voltage Film Capacitors," *Polymers*, 2021, doi: 10.3390/polym13050766.
- 1022 [37] TDK Electronics, "Aluminum Electrolytic Capacitors - General technical information," 2019,
1023 Accessed: Nov. 01, 2022. [Online]. Available: [https://www.tdk-](https://www.tdk-electronics.tdk.com/download/185386/e724fb43668a157bc547c65b0cff75f8/pdf-generaltechnicalinformation.pdf)
1024 [electronics.tdk.com/download/185386/e724fb43668a157bc547c65b0cff75f8/pdf-](https://www.tdk-electronics.tdk.com/download/185386/e724fb43668a157bc547c65b0cff75f8/pdf-generaltechnicalinformation.pdf)
1025 [generaltechnicalinformation.pdf](https://www.tdk-electronics.tdk.com/download/185386/e724fb43668a157bc547c65b0cff75f8/pdf-generaltechnicalinformation.pdf)
- 1026 [38] Exxelia, "Electrolytic Aluminum Capacitors Technical data." 2017. Accessed: Nov. 01, 2022.
1027 [Online]. Available: [https://exxelia.com/uploads/PDF/aluminum-electrolytic-capacitors-catalog-](https://exxelia.com/uploads/PDF/aluminum-electrolytic-capacitors-catalog-6298a1c93f65a.pdf)
1028 [6298a1c93f65a.pdf](https://exxelia.com/uploads/PDF/aluminum-electrolytic-capacitors-catalog-6298a1c93f65a.pdf)
- 1029 [39] P. Venet, "Amélioration de la sûreté de fonctionnement des dispositifs de stockage d'énergie."
1030 (Doctoral dissertation, Université Claude Bernard-Lyon I), 2007.
- 1031 [40] A. E. Hayek, "Analyse de vieillissement, estimation de la durée de vie et méthode de surveillance
1032 de l'état de santé des condensateurs électrolytiques." Doctoral dissertation, Université de Lyon,
1033 2020.
- 1034 [41] United Chemi-Con, "Aluminum electrolytic capacitors." Rosemont, 2021. Accessed: Nov. 01, 2022.
1035 [Online]. Available: <https://www.chemi-con.co.jp/en/catalog/pdf/al-e/al-all-e1001u-2020.pdf>
- 1036 [42] Y. Freeman, P. Lessner, and I. Luzinov, "Reliability and Failure Mode in Solid Tantalum Capacitors,"
1037 *ECS Journal of Solid State Science and Technology*, 2021, doi: 10.1149/2162-8777/abf728.
- 1038 [43] F. Larmat, J. R. Reynolds, and Y.-J. Qiu, "Polypyrrole as a solid electrolyte for tantalum capacitors,"
1039 *Synthetic Metals*, 1996, doi: 10.1016/0379-6779(96)80198-6.
- 1040 [44] YAGEO Corporation, "MLCC replacements for tantalum capacitors." 2002. [Online]. Available:
1041 <https://studylib.net/doc/18038548/mlcc-replacements-for-tantalum-capacitors>
- 1042 [45] Y. Freeman and P. Lessner, "Evolution of Polymer Tantalum Capacitors," *Applied Sciences*, 2021,
1043 doi: 10.3390/app11125514.
- 1044 [46] Jiaoying Huang, Yongkang Wan, Cheng Gao, and Yuanyuan Xiong, "Discussion on multilayer
1045 ceramic replacements for tantalum capacitors," in *Prognostics and System Health Management*
1046 *Conference (PHM)*, 2015, pp. 1–5. doi: 10.1109/PHM.2015.7380064.
- 1047 [47] E. K. Reed, "Characterization of Tantalum Polymer Capacitors." NASA Electronic Parts and
1048 Packaging Program, NEPP Task, 2006.
- 1049 [48] V. Sprague, "Solid Tantalum Surface Mount Chip Capacitors TANTAMOUNT™, Molded Case,
1050 Standard Industrial Grade," 2021, Accessed: Nov. 01, 2022. [Online]. Available:
1051 <https://www.tme.eu/Document/b7b423fee79a0baa3802818aefa8a73f/293d.pdf>
- 1052 [49] I. Bishop and J. Gill, "Reverse voltage behavior of solid tantalum capacitors, Technical
1053 information." AVX Ltd, 2013.
- 1054 [50] K. Kim, J. Park, G. Cha, J. E. Yoo, and J. Choi, "Electrochemical etching of a niobium foil in
1055 methanolic HF for electrolytic capacitor," *Materials Chemistry and Physics*, 2013, doi:
1056 10.1016/j.matchemphys.2013.06.008.
- 1057 [51] E. N. Tarekegn, W. R. Harrell, I. Luzinov, P. Lessner, and Y. Freeman, "Environmental Stability of
1058 Polymer Tantalum Capacitors," *ECS Journal of Solid State Science and Technology*, 2022, doi:
1059 10.1149/2162-8777/abba02.
- 1060 [52] T. S. Kumar, S. R. Kumar, M. L. Rao, and T. L. Prakash, "Preparation of Niobium Metal Powder by
1061 Two-Stage Magnesium Vapor Reduction of Niobium Pentoxide," *Journal of Metallurgy*, 2013, doi:
1062 <https://doi.org/10.1155/2013/629341>.
- 1063 [53] T. Kárník, "NIOBIUM OXIDE FOR CAPACITOR MANUFACTURING," *Metal*, 2008.
- 1064 [54] H. Zillgen and M. Stenzel, "New Niobium Capacitors with stable electrical parameters," *Active and*
1065 *Passive Electronic Components*, 2001.

- 1066 [55] Y. Freeman, *Tantalum and Niobium-Based Capacitors*. Springer International Publishing, 2018. doi:
 1067 10.1007/978-3-319-67870-2.
- 1068 [56] A. Shrivastava, "RELIABILITY EVALUATION OF LIQUID AND POLYMER ALUMINUM ELECTROLYTIC
 1069 CAPACITORS," p. 113.
- 1070 [57] J. Yoo, "Liquid electrolyte-free cylindrical Al polymer capacitor review: Materials and
 1071 characteristics," *Journal of Power Sources*, 2015, doi:
 1072 <https://doi.org/10.1016/j.jpowsour.2015.03.023>.
- 1073 [58] M. Agrawal, R. Singh, M. Ranitović, Z. Kamberovic, C. Ekberg, and K. K. Singh, "Global market trends
 1074 of tantalum and recycling methods from Waste Tantalum Capacitors: A review," *Sustainable
 1075 Materials and Technologies*, 2021, doi: 10.1016/j.susmat.2021.e00323.
- 1076 [59] A. Dehbi, W. Wondrak, Y. Ousten, and Y. Danto, "High temperature reliability testing of aluminum
 1077 and tantalum electrolytic capacitors," *Microelectronics Reliability*, 2002, doi: 10.1016/S0026-
 1078 2714(02)00021-5.
- 1079 [60] V. Sprague, "AC Ripple Current Calculations." Application Notes, 2002. Accessed: Nov. 01, 2022.
 1080 [Online]. Available: <https://www.vishay.com/docs/40031/appripppl.pdf>
- 1081 [61] R. U. A. Shaikh, A. Saeed, and R. Kumar, "Review on present and future integration techniques for
 1082 capacitors in motor drives," in *2018 International Conference on Computing, Mathematics and
 1083 Engineering Technologies (iCoMET)*, Mar. 2018. doi: 10.1109/ICOMET.2018.8346442.
- 1084 [62] O. Ondel, E. Boutleux, and P. Venet, "A decision system for electrolytic capacitors diagnosis," in
 1085 *35th Annual Power Electronics Specialists Conference*, 2004. doi: 10.1109/PESC.2004.1354771.
- 1086 [63] K. Abdennadher, P. Venet, G. Rojat, J.-M. Retif, and C. Rosset, "A Real-Time Predictive-
 1087 Maintenance System of Aluminum Electrolytic Capacitors Used in Uninterrupted Power Supplies,"
 1088 *IEEE Transactions on Industry Applications*, 2010, doi: 10.1109/TIA.2010.2049972.
- 1089 [64] D. A. John and K. Biswas, "Electrical equivalent circuit modelling of solid state fractional capacitor,"
 1090 *AEU - International Journal of Electronics and Communications*, 2017, doi:
 1091 10.1016/j.aeue.2017.05.008.
- 1092 [65] J. Čuntala, M. Frivaldský, and A. Kondelová, "Thermal simulation of electrolytic capacitor during
 1093 impulse operation," 2014.
- 1094 [66] A. L. d'Entremont, "Thermal modeling of electrochemical capacitors." Doctoral dissertation,
 1095 University of California, Los Angeles, 2015.
- 1096 [67] S. G. Parler, "Thermal modeling of aluminum electrolytic capacitors," in *Conference Record of the
 1097 1999 IEEE Industry Applications Conference. Thirty-Forth IAS Annual Meeting (Cat.
 1098 No.99CH36370)*, 1999. doi: 10.1109/IAS.1999.799180.
- 1099 [68] F. Perisse, P. Venet, G. Rojat, and J. M. Rétif, "Simple model of an electrolytic capacitor taking into
 1100 account the temperature and aging time," *Electrical Engineering*, 2006, doi: 10.1007/s00202-004-
 1101 0265-z.
- 1102 [69] P. Freiburger, "Transient thermal modeling of aluminum electrolytic capacitors under varying
 1103 mounting boundary conditions," in *2015 21st International Workshop on Thermal Investigations
 1104 of ICs and Systems*, 2015. doi: 10.1109/THERMINIC.2015.7389619.
- 1105 [70] Z. Fan, N. Islam, and S. B. Bayne, "Towards kilohertz electrochemical capacitors for filtering and
 1106 pulse energy harvesting," *Nano Energy*, 2017, doi: 10.1016/j.nanoen.2017.06.048.
- 1107 [71] H. Soliman and H. Wang, "A Review of the Condition Monitoring of Capacitors in Power Electronic
 1108 Converters," *IEEE Transactions on Industry Applications*, 2016, doi:
 1109 10.1109/OPTIM.2015.7427012.
- 1110 [72] M. Catelani, L. Ciani, R. Singuaroli, and A. Mannucci, "Electrolytic Capacitor Lifetime Prediction in
 1111 Ground Mobile Applications." 13th IMEKO TC10 Workshop on Technical Diagnostics, 2014.
- 1112 [73] S. R. McCormick, K. Hur, S. Santoso, A. Maitra, and A. Sundaram, "Capacitor bank predictive
 1113 maintenance and problem identification using conventional power quality monitoring systems,"
 1114 in *Power Engineering Society General Meeting*, 2004. doi: 10.1109/PES.2004.1373199.
- 1115 [74] A. E. Hayek, P. Venet, G. Clerc, M. Wang, R. Mitova, and A. Sari, "Estimation of the remaining Useful
 1116 Life of capacitors." U.S. Patent Application No 16/878,499, 2020.

- 1117 [75] H. Malek, S. Dadras, and Y. Chen, "Fractional order equivalent series resistance modelling of
1118 electrolytic capacitor and fractional order failure prediction with application to predictive
1119 maintenance," *IET Power Electronics*, 2016, doi: 10.1049/iet-pel.2015.0636.
- 1120 [76] P. Venet, H. Darnand, and G. Grellet, "Detection of faults of filter capacitors in a converter.
1121 Application to predictive maintenance," in *Proceedings of Intelec 93: 15th International
1122 Telecommunications Energy Conference*, 1993. doi: 10.1109/INTLEC.1993.388568.
- 1123 [77] Kwang-Woon Lee, Myungchul Kim, Jangho Yoon, Sang Bin Lee, and Ji-Yoon Yoo, "Condition
1124 Monitoring of DC-Link Electrolytic Capacitors in Adjustable-Speed Drives," *IEEE Transactions on
1125 Industry Applications*, 2008, doi: 10.1109/TIA.2008.2002220.
- 1126 [78] J. R. Celaya, C. Kulkarni, S. Saha, G. Biswas, and K. Goebel, "Accelerated aging in electrolytic
1127 capacitors for prognostics," in *Proceedings Annual Reliability and Maintainability Symposium*,
1128 2012. doi: 10.1109/RAMS.2012.6175486.
- 1129 [79] M. L. Gasperi, "Life Prediction Modeling of Bus Capacitors in AC Variable-Frequency Drives," *IEEE
1130 Transactions on Industry Applications*, 2005, doi: 10.1109/TIA.2005.858258.
- 1131 [80] Y. Kudoh, M. Fukuyama, and S. Yoshimura, "Stability study of polypyrrole and application to highly
1132 thermostable aluminum solid electrolytic capacitor," *Synthetic Metals*, 1994, doi: 10.1016/0379-
1133 6779(94)90093-0.
- 1134 [81] B. Alvsten, *Electrolytic capacitors theory and application*, RIFA Electrolytic Capacitors. Sweden,
1135 1995.
- 1136 [82] C. Joubert, G. Rojat, and P. Venet, "Capacitors: revisiting a classical technology to face new
1137 challenges," International conference Automotive Power Electronics, Paris, 2007.
- 1138 [83] A. Lahyani, P. Venet, G. Grellet, and P.-J. Viverge, "Failure prediction of electrolytic capacitors
1139 during operation of a switchmode power supply," *IEEE Transactions on Power Electronics*, 1998,
1140 doi: 10.1109/63.728347.
- 1141 [84] M. L. Gasperi, "Life prediction model for aluminum electrolytic capacitors," in *IAS '96. Conference
1142 Record of the Industry Applications Conference Thirty-First IAS Annual Meeting*, 1996. doi:
1143 10.1109/IAS.1996.559241.
- 1144 [85] C. S. Kulkarni, "A Physics-Based Degradation Modeling Framework for Diagnostic and Prognostic
1145 Studies in Electrolytic Capacitors." Doctoral dissertation, Vanderbilt University, 2013.
- 1146 [86] C. S. Kulkarni, G. Biswas, J. R. Celaya, and K. Goebel, "Physics Based Degradation Models for
1147 Electrolytic Capacitor Prognostics under Thermal Overstress Conditions," *International Journal of
1148 Prognostics and Health Management*, 2012, doi: 10.36001/ijphm.2013.v4i1.1448.
- 1149 [87] D. A. Albertsen, "Electrolytic Capacitor Lifetime Estimation." JIANGHAI Eur. GmbH, 2010.
- 1150 [88] A. Shrivastava *et al.*, "Detection of capacitor electrolyte residues with FTIR in failure analysis," *J
1151 Mater Sci: Mater Electron*, vol. 25, no. 2, pp. 635–644, Feb. 2014, doi: 10.1007/s10854-013-1146-
1152 x.
- 1153 [89] A. M. Imam, D. M. Divan, R. G. Harley, and T. G. Habetler, "Electrolytic Capacitor Failure
1154 Mechanism Due to Inrush Current," *IEEE Industry Applications Annual Meeting*, 2007, doi:
1155 10.1109/07IAS.2007.115.
- 1156 [90] F. Perisse, "Etude et analyse des modes de défaillances des condensateurs électrolytiques à
1157 l'aluminium et des thyristors, appliquées au système de protection du LHC." Doctoral dissertation,
1158 Université Claude Bernard Lyon 1, 2003.
- 1159 [91] J. Pavelka, J. Sikula, P. Vasina, V. Sedlakova, M. Tacano, and S. Hashiguchi, "Noise and transport
1160 characterisation of tantalum capacitors," *Microelectronics Reliability*, 2002, doi:
1161 [https://doi.org/10.1016/S0026-2714\(02\)00013-6](https://doi.org/10.1016/S0026-2714(02)00013-6).
- 1162 [92] K. Hasegawa, K. Tsuzaki, and S. Nishizawa, "DC-bias-voltage dependence of degradation of
1163 aluminum electrolytic capacitors," *Microelectronics Reliability*, 2018, doi:
1164 10.1016/j.microrel.2018.02.012.
- 1165 [93] U.S of A. D. of Defense, "Military HandBook - Reliability prediction of electronic equipment," p.
1166 150, 1991.

- 1167 [94] J. Renwick, C. S. Kulkarni, and J. R. Celaya, "Analysis of Electrolytic Capacitor Degradation under
1168 Electrical Overstress for Prognostic Studies," 2015, doi:
1169 <https://doi.org/10.36001/phmconf.2015.v7i1.2713>.
- 1170 [95] Fixed Electrolytic, "General specification for capacitors (MIL-C-62F)," 2008.
- 1171 [96] International Electrotechnical Commission, "IEC 60068-1 : Environmental testing," 1988.
- 1172 [97] E. Vitoratos *et al.*, "Thermal degradation mechanisms of PEDOT:PSS," *Organic Electronics*, 2009,
1173 doi: 10.1016/j.orgel.2008.10.008.
- 1174 [98] Y. Pozdeev, "Reliability comparison of tantalum and niobium solid electrolytic capacitors," *Quality
1175 and Reliability Engineering International*, 1998, doi: 10.1002/(SICI)1099-
1176 1638(199803/04)14:2<79::AID-QRE163>3.0.CO;2-Y.
- 1177 [99] T. Zednicek, "Voltage Derating Rules for solid tantalum and niobium capacitors." 2003. Accessed:
1178 Nov. 01, 2022. [Online]. Available: [https://www.kyocera-avx.com/news/voltage-derating-rules-
1179 for-solid-tantalum-and-niobium-capacitors/](https://www.kyocera-avx.com/news/voltage-derating-rules-for-solid-tantalum-and-niobium-capacitors/)
- 1180 [100] B. Goudswaard, F. J. J. Driesens, N. V. Philips, and P. D. Elcoma, "Failure mechanism of solid
1181 tantalum capacitors," 1976, doi: 10.1155/APEC.3.171.
- 1182 [101] B. Akkopru-Akgun, S. Troler-McKinstry, and M. T. Lanagan, "MnO₂ Thin Film Electrodes for
1183 Enhanced Reliability of Thin Glass Capacitors," *Journal of the American Ceramic Society*, 2015, doi:
1184 10.1111/jace.13774.
- 1185 [102] J. Prymark, "Derating review of Ta MnO₂ vs. Ta polymer vs. Al polymer vs. NbO MnO₂," 2004.
- 1186 [103] AVX, "Surface Mount Tantalum Capacitors." 2013. Accessed: Nov. 01, 2022. [Online]. Available:
1187 <https://www.farnell.com/datasheets/2613.pdf>
- 1188 [104] P. Venet and F. Perisse, "Realization of a smart electrolytic capacitor," *IEEE Industry Applications
1189 Magazine*, 2002, doi: 10.1109/2943.974353.
- 1190 [105] C. Kulkarni, G. Biswas, X. Koutsoukos, J. Celaya, and K. Goebel, "Experimental Studies of Ageing
1191 in Electrolytic Capacitors." Vanderbilt University Nashville, Dept of Electrical Engineering and
1192 Computer Science, 2010.
- 1193 [106] A. Zanobini, G. Iuculano, and A. Falciani, "Automatic-Test Equipment for the Characterization of
1194 Aluminum Electrolytic Capacitors," *IEEE Transactions on Instrumentation and Measurement*, 2006,
1195 doi: 10.1109/TIM.2006.870333.
- 1196 [107] C. Bhargava, V. K. Banga, and Y. Singh, "An intelligent prognostic model for electrolytic capacitors
1197 health monitoring: A design of experiments approach," *Advances in Mechanical Engineering*, 2018,
1198 doi: 10.1177/1687814018781170.
- 1199 [108] H. Qingchuan, C. Wenhua, P. Jun, and Q. Ping, "Improved step stress accelerated life testing
1200 method for electronic product," *Microelectronics Reliability*, 2012, doi:
1201 10.1016/j.microrel.2012.04.003.
- 1202 [109] H. S. Endicott, B. D. Hatch, and R. G. Sohmer, "Application of the Eyring Model to capacitor Aging
1203 Data," *IEEE Transactions on Component Parts*, 1965, doi: 10.1109/EIC.1962.7466672.
- 1204 [110] N. Delmonte, D. Cabezuelo, I. Kortabarria, D. Santoro, A. Toscani, and P. Cova, "A method to
1205 extract lumped thermal networks of capacitors for reliability oriented design," *Microelectronics
1206 Reliability*, 2020, doi: 10.1016/j.microrel.2020.113737.
- 1207 [111] A. R. Khandebharad, R. B. Dhumale, S. S. Lokhande, and S. D. Lokhande, "Real time remaining
1208 useful life prediction of the electrolytic capacitor," in *International Conference on Information
1209 Processing (ICIP)*, Pune, India, 2015. doi: 10.1109/INFOP.2015.7489460.
- 1210 [112] P. Spanik, M. Frivaldsky, and A. Kanovsky, "Life time of the electrolytic capacitors in power
1211 applications," in *ELEKTRO*, 2014. doi: 10.1109/ELEKTRO.2014.6848893.
- 1212 [113] S. G. Parler, "Deriving Life Multipliers for Electrolytic Capacitors." IEEE Power Electronics Society
1213 Newsletter, 2004.
- 1214 [114] Technical Notes, "Judicious Use of Aluminum Electrolytic Capacitors." Nippon Chemi-Con.
1215 Accessed: Nov. 01, 2022. [Online]. Available: [https://chemi-con.com/wp-
1216 content/uploads/2021/04/Technical-Notes.pdf](https://chemi-con.com/wp-content/uploads/2021/04/Technical-Notes.pdf)
- 1217 [115] H. Gualous *et al.*, "Supercapacitor ageing at constant temperature and constant voltage and
1218 thermal shock," *Microelectronics Reliability*, 2010, doi: 10.1016/j.microrel.2010.07.144.

- 1219 [116]R. Jano and D. Pitica, "Accelerated ageing tests of aluminum electrolytic capacitors for evaluating
1220 lifetime prediction models," p. 6, 2012.
- 1221 [117]P. Kreczanik, P. Venet, A. Hijazi, and G. Clerc, "Study of Supercapacitor Aging and Lifetime
1222 Estimation According to Voltage, Temperature, and RMS Current," *IEEE Transactions on Industrial
1223 Electronics*, 2014, doi: 10.1109/TIE.2013.2293695.
- 1224 [118]G. E. Rhoades and A. W. H. Smith, "Expected life of capacitors with nonsolid electrolyte." 34th
1225 Component conf. Proc., 1984.
- 1226 [119]L. Cathey and K. A. Joyner, "Investigation of the Dissipation Process in Electrolytic Capacitors,"
1227 *ElectroComponent Science and Technology*, 1980, doi: 10.1155/APEC.6.49.
- 1228 [120]K. Harada, A. Katsuki, and M. Fujiwara, "Use of ESR for Deterioration Diagnosis of Electrolytic
1229 Capacitor," *IEEE Transactions on Power Electronics*, 1993, doi: 10.1109/63.261004.
- 1230 [121]Hao Ma and Linguo Wang, "Fault diagnosis and failure prediction of aluminum electrolytic
1231 capacitors in power electronic converters," in *31st Annual Conference of IEEE Industrial Electronics
1232 Society*, 2005. doi: 10.1109/IECON.2005.1569014.
- 1233 [122]Y. Yu, T. Zhou, M. Zhu, and D. Xu, "Fault Diagnosis and Life Prediction of DC-link Aluminum
1234 Electrolytic Capacitors Used in Three-phase AC/DC/AC Converters," in *2012 Second International
1235 Conference on Instrumentation, Measurement, Computer, Communication and Control*, 2012. doi:
1236 10.1109/IMCCC.2012.199.
- 1237 [123]B. Sun, X. Fan, C. Qian, and G. Zhang, "PoF-Simulation-Assisted Reliability Prediction for
1238 Electrolytic Capacitor in LED Drivers," *IEEE Transactions on Industrial Electronics*, 2016, doi:
1239 10.1109/TIE.2016.2581156.
- 1240 [124]V. N. A. Naikan and A. Rathore, "Accelerated temperature and voltage life tests on aluminium
1241 electrolytic capacitors: A DOE approach," *International Journal of Quality & Reliability
1242 Management*, 2016, doi: 10.1108/IJQRM-12-2014-0201.
- 1243 [125]H. M. Pang and P. M. H. Bryan, "A life prediction scheme for electrolytic capacitors in power
1244 converters without current sensor," in *Twenty-Fifth Annual IEEE Applied Power Electronics
1245 Conference and Exposition (APEC)*, Feb. 2010. doi: 10.1109/APEC.2010.5433384.
- 1246 [126]J. R. Celaya, C. Kulkarni, G. Biswas, S. Saha, and K. Goebel, "A Model-based Prognostics
1247 Methodology for Electrolytic Capacitors Based on Electrical Overstress Accelerated Aging." Annual
1248 Conference of the PHM Society, 2011.
- 1249 [127]D. McLean and F. Power, "Tantalum Solid Electrolytic Capacitors," *Proceedings of the IRE*, 1956,
1250 doi: 10.1109/JRPROC.1956.275141.
- 1251 [128]K. Abdennadher, P. Venet, G. Rojat, J.-M. Rétif, and C. Rosset, "Online monitoring method and
1252 electrical parameter ageing laws of aluminium electrolytic capacitors used in UPS." EPE, 2009.
- 1253 [129]M. Randall, T. Kinard, J. Qazi, R. Hahn, and P. Lessner, "The Battle for Maximum Volumetric
1254 Efficiency – Part 2: Advancements in Solid Electrolyte Capacitors," *CARTS Europe 2007 Symposium*,
1255 2007.
- 1256 [130]R. Andersson, M. Bylund, S. Krause, A. M. Saleem, and V. Desmaris, "Integrated and Discrete
1257 Capacitors Based on Carbon Nanostructures with Capacitance Densities in Excess of 200 nF/mm²,"
1258 2019.
- 1259 [131]H. Choi and H. Yoon, "Nanostructured Electrode Materials for Electrochemical Capacitor
1260 Applications," *Nanomaterials*, 2015, doi: 10.3390/nano5020906.
1261