



HAL
open science

Optimization of a small passive wind turbine based on mixed Weibull-turbulence statistics of wind

Xavier Roboam, Abdenour Abdelli, Bruno Sareni

► **To cite this version:**

Xavier Roboam, Abdenour Abdelli, Bruno Sareni. Optimization of a small passive wind turbine based on mixed Weibull-turbulence statistics of wind. 9th International Conference on Modeling and Simulation of Electric Machines, Converters and Systems (ELECTRIMACS'08), Jun 2008, Québec, Canada. pp.0. hal-04044521

HAL Id: hal-04044521

<https://hal.science/hal-04044521>

Submitted on 24 Mar 2023

HAL is a multi-disciplinary open access archive for the deposit and dissemination of scientific research documents, whether they are published or not. The documents may come from teaching and research institutions in France or abroad, or from public or private research centers.

L'archive ouverte pluridisciplinaire **HAL**, est destinée au dépôt et à la diffusion de documents scientifiques de niveau recherche, publiés ou non, émanant des établissements d'enseignement et de recherche français ou étrangers, des laboratoires publics ou privés.



Open Archive TOULOUSE Archive Ouverte (OATAO)

OATAO is an open access repository that collects the work of Toulouse researchers and makes it freely available over the web where possible.

This is an author-deposited version published in : <http://oatao.univ-toulouse.fr/>
Eprints ID : 9256

To cite this version : Roboam, Xavier and Abdelli, Abdenour and Sareni, Bruno. *Optimization of a small passive wind turbine based on mixed Weibull-turbulence statistics of wind*. In: 9th International Conference on Modeling and Simulation of Electric Machines, Converters and Systems (ELECTRIMACS'08), 08-10 Jun 2008, Québec, Canada.

concerning this service should be sent to the repository administrator: staff-oatao@listes-diff.inp-toulouse.fr

Optimization of a small passive wind turbine based on mixed Weibull-turbulence statistics of wind

X. Roboam, A. Abdelli, B. Sareni

Université de Toulouse, LAPLACE (CNRS, INPT, UPS)
Site ENSEEIHT, 2 Rue Camichel, BP7122, 31071 Toulouse Cedex 7, France
name@laplace.univ-tlse.fr

Abstract –A“low cost full passive structure” of wind turbine system is proposed. The efficiency of such device can be obtained only if the design parameters are mutually adapted through an optimization design approach. An original wind profile generation process mixing Weibull and turbulence statistics is presented. The optimization results are compared with those obtained from a particular but typical time cycle of wind speed.

I. INTRODUCTION

Close to high power wind turbines for On or Offshore applications, small wind systems constitute an interesting target for applications such as rural electrification, autonomous energy production networks for water pumping, desalination, etc. Optimizing energy efficiency generally leads to adapt the load impedance and consequently the speed of the generator to the wind turbine operating conditions. Many active structures are then proposed [1-4] that allows tracking the maximum power operation through corresponding MPPT strategies.

However, for such application frame, the system cost has to be drastically minimized especially by simplifying the structure with PM synchronous generator feeding a diode rectifier associated with a battery bus. For grid connected applications, impedance adaptation can be obtained through the grid inverter as in [2]. In this paper, we propose a very “low cost structure” for remote applications, without active control unit and with a minimum number of sensors. In fact, for such device, a “natural” impedance adaptation can be achieved with the passive structure by optimizing the accordance between system parameters [4-7].

After a brief description of the system modeling, such optimization process is presented. Due to the importance of wind energetic content for the system behavior, we finally propose a wind profile generation process mixing Weibull and turbulence statistics. The optimization results obtained with this generation process are compared with others given by a particular cycle test.

II. THE WIND TURBINE SYSTEM MODEL

In order to minimize the system cost and to maximize its reliability, the “full passive” architecture of Fig.1 is put forward. This structure is mainly dedicated to small scale wind turbines, especially for remote systems. A battery bank is then associated to a passive diode rectifier to allow an autonomous system operation. A minimum number of sensors and no control unit are required in this “low cost” structure.

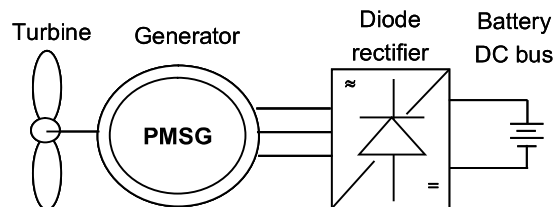

Fig. 1. “Full passive” structure of the wind turbine system

A. The wind turbine model

A Savonius Vertical Axis Wind Turbine of radius $R = 0.5\text{m}$ and height $H = 2\text{m}$ is considered as case study (see Fig. 2). Note that the proposed structure and the corresponding design process could be applied for any vertical or horizontal axis turbines. However, due to its bell shape power coefficient ($C_p(\lambda)$), the Savonius turbine requires to conveniently adapt the shaft speed with respect to wind levels. Thus, it is certainly a good application to show the efficiency of the optimization based design of the passive structure.

In this particular case study, the power coefficient (C_p) is defined by the following empiric interpolation:

$$C_p = -0.1299\lambda^3 - 0.1168\lambda^2 + 0.4540\lambda \quad (1)$$

where λ denotes the tip speed ratio, depending on the turbine rotational speed Ω and the wind speed V_w .

$$\lambda = \frac{R\Omega}{V_w} \quad (2)$$

The associated wind turbine power can be expressed as:

$$P_{WT} = \frac{1}{2} C_p \rho A V_w^3 \quad (3)$$

where ρ denotes the air density ($\rho \sim 1.2\text{ kg}\cdot\text{m}^{-3}$) and where A represents the swept rotor area.

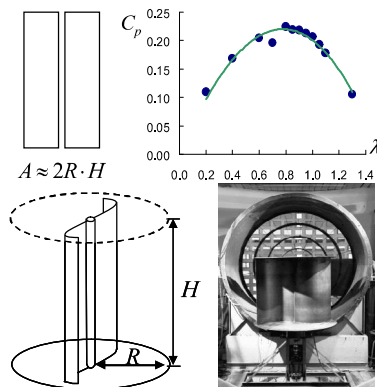

Fig. 2. Power coefficient of a Savonius wind turbine

The electromagnetic torque of the generator is defined as:

$$T_{em} = T_{WT} - J_{WT} \frac{d\Omega}{dt} - F_{WT} \Omega \quad (4)$$

where the wind turbine inertia and the damping coefficient are respectively $J_{WT} = 16 \text{ kg.m}^2$ and $F_{WT} = 0.06 \text{ N.m.s/rad}$, Ω being the mechanical shaft speed.

Note that the wind power is maximum when the power coefficient is maximum ($C_p^* \approx 0.22$), i.e. for the optimal tip speed ratio ($\lambda^* \approx 0.82$). For various wind speed values, the rotor speed should be adapted to operate at the optimal tip speed ratio.

B. The generator – rectifier association model

In order to optimize the wind turbine system, a specific model has to be developed. A first step consists in defining a sizing model that links geometrical parameters with circuit parameters of the generator. The Slemon sizing model [8] has been chosen for that purpose as detailed in [9] and illustrated in Fig.3. Eight design variables are considered as model inputs from which circuit output parameters (stator resistance, main & leakage inductance, magnet flux) are analytically derived. This model has been validated through Finite Element Method (FEM) and shows good accordance for the considered application [6].

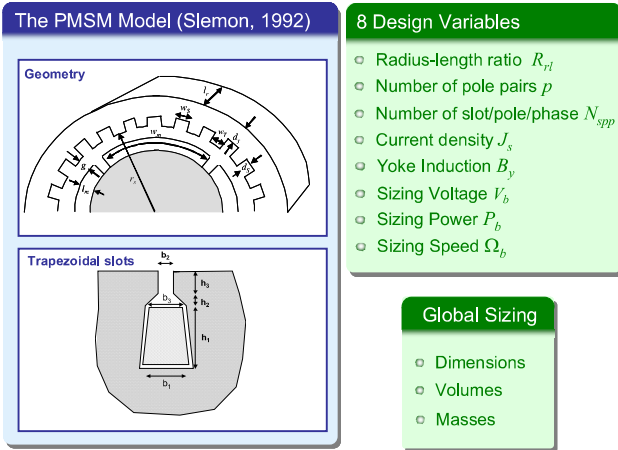

Fig. 3. Illustration of the generator sizing model

o The reference model

A “reference model” has firstly been proposed in order to validate the temporal system simulation. This model associates a complete (a,b,c) circuit model of the generator with a complete diode bridge rectifier including ideal switches but taking into account the diode overlapping during switching intervals.

This model also includes the thermal behaviour of the generator (slot copper, slot insulators, stator yoke) evaluated from magnetic and electrical losses. Joule losses are classically computed from the generator current and stator resistance, while magnetic losses are estimated from hysteresis and eddy current losses in the stator parts (i.e. yoke and teethes) according to [14].

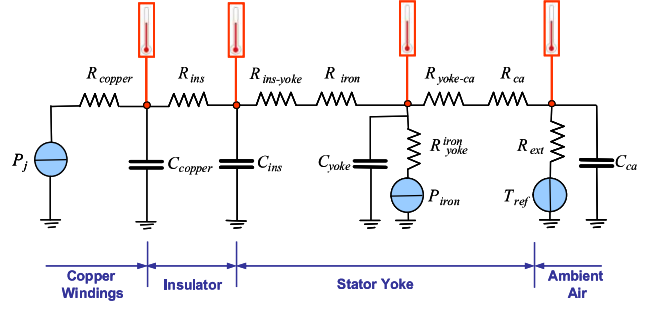

Fig. 4. The thermal model of the generator (stator part)

Since the computational cost associated with the reference model is really too much important in the framework of a system optimization, surrogate models have been developed in order to reduce computing times.

o The mixed reduced model

In particular, for the system simulation, a simplified causal model is used where the synchronous generator with the diode bridge association is replaced with an energetically equivalent DC model valid in average value.

A “DC equivalent model” that simulates electrical and mechanical modes and takes into account the voltage drops due to diode overlapping and magnetic reactance has been detailed in [6]. The correspondence between AC (rms) values and DC ones are given in Table 1.

TABLE I: AC-DC correspondence for model reduction

Electromotive force $E_{sDC} = \frac{3\sqrt{6}}{\pi} E_s$	Magnetic Flux $\Phi_{DC} = \frac{3\sqrt{6}}{\pi} \Phi_s$
Stator resistance $R_{DC} = 3 \left(\frac{\sqrt{6}}{\pi} \right)^2 R_s$	Stator inductance $L_{DC} = 3 \left(\frac{\sqrt{6}}{\pi} \right)^2 L_s$

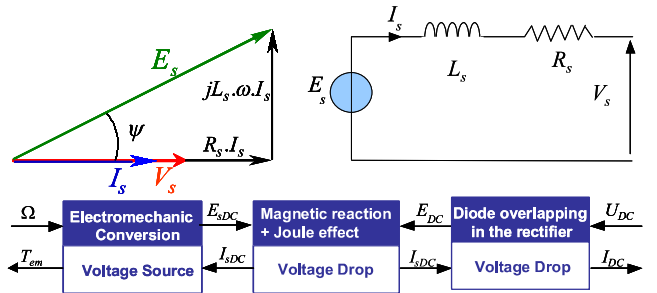

Fig. 5. The “mixed reduced model”

However, when only the energetic system behavior is concerned in the optimization process, the electrical mode effect can be neglected and a further model reduction can be achieved [7]. We have then proposed the “mixed reduced model” that only simulates the mechanical and thermal modes, the whole electrical parts being analytically derived as in (5) :

$$I_{sDC}^2 + \frac{2U_{DC}(R_{emp} + R_{DC})}{(L_{DC}\omega)^2 + (R_{emp} + R_{DC})^2} I_{sDC} + \frac{U_{DC}^2 - E_{sDC}^2}{(L_{DC}\omega)^2 + (R_{emp} + R_{DC})^2} = 0 \quad (5)$$

where $R_{emp} \cdot I_{sDC}$ is the voltage drop due to diode overlapping effects with $R_{emp} = 3L_s\omega / \pi$. Note that this voltage drop is

power conservative as expressed in (7). The synoptic of this model is given in Fig. 5. The causality is symbolized by arrows specifying which physical variables (energetic efforts or flows) are applied in each part of the system. We also mention the relationships allowing the simulation of the electromechanical conversion (6) and of the voltage drop due to the diode overlapping (7).

$$\begin{cases} T_{em} = p\Phi_{DC}I_{sDC} \\ E_{sDC} = p\Phi_{DC}\Omega \end{cases} \quad (6)$$

$$\begin{cases} E_{DC} = U_{DC} + R_{emp}I_{sDC} \\ I_{DC} = E_{DC}I_{sDC} / U_{DC} \end{cases} \quad (7)$$

where p denotes the pole pair number of the generator and ω denotes the electric angular pulsation associated with the rotor.

In Fig.6, the wind turbine system output power (P_{out}) for both models simulated for a particular wind cycle test have been superposed. Even if the shapes of these curves differ, one can see that the average powers are really close for both models.

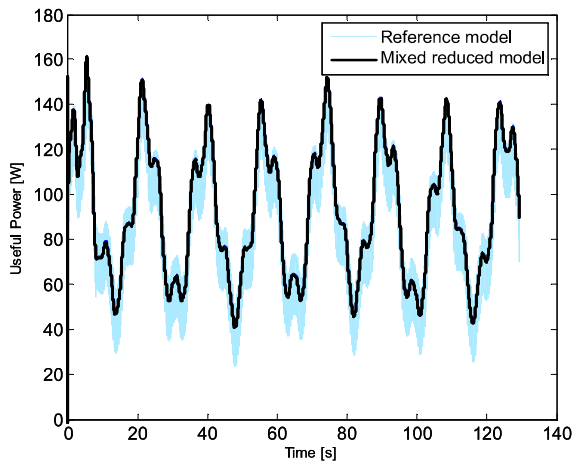

Fig.6 : Output power for “reference” and “mixed reduced” models

As the two models are compared, the differences on other system variables (torque, speed, currents, and losses) are also slight. Other details on the model reduction issues are given in [6,7]. On the other hand, the computation time on a PC computer is 17 min for the “reference model” but only 1s for the “mixed reduced model”. Thanks to this model reduction, the optimization of the full passive wind turbine system can be efficiently performed.

III. THE OPTIMIZATION PROCESS

A. Design Variables, Objectives and Constraints

The design variables considered for the wind turbine optimization are composed of six continuous variables (i.e. R_{rt} , P_b , Ω_b , V_b , B_y , and J_c) and two discrete (i.e. p and N_{spp}). Two conflicting objectives have to be optimized: the “useful output power” has to be maximized while minimizing the total mass of the embedded system. The “useful output power” is defined as the power extracted from the wind cycle reduced from all losses in the wind turbine system (i.e. mechanical losses in the turbine, Joule and iron losses in the

generator and conduction losses in the diode rectifier). As underlined previously, all losses in the synchronous generator are computed according to [9,14] and the conduction losses P_{cond} in a diode of the rectifier are classically evaluated as follows:

$$P_{cond} = u_d i_d + R_d i_d^2 \quad (8)$$

where u_d denotes the diode voltage drop and R_d represents the diode internal resistance (typically $R_d = 3.4 \text{ m}\Omega$ and $u_d = 0.8 \text{ V}$). Note that switching losses have been neglected.

The embedded mass of the system is obtained by considering the wind turbine mass as constant ($M_{WT} \approx 48 \text{ kg}$) with the variable generator mass. This mass is computed from the volume of each constitutive component (iron, magnet, copper windings) and the corresponding mass density according to [9]. Note that the rectifier mass has been neglected.

Moreover, five constraints have to be fulfilled to ensure the wind turbine feasibility and to allow complying with the wind cycle. These constraints concern the number of wires per slot, the maximum temperature associated with the copper windings in the generator, the demagnetization limit of the magnets and the maximum temperature in the semiconductor junctions. They are computed similarly to [9].

B. The Optimization Process

The Non dominated Sorting Genetic Algorithm (NSGAI) [10,11] is applied for the optimization of the “full passive” wind turbine generator. To take into account the design constraints in the NSGA-II, the Pareto-dominance rule is modified as follows:

- if two individuals are non-feasible, the Pareto-dominance relative to these individuals is applied in the constraint space.
- if two individuals are feasible, the Pareto-dominance relative to these individuals is applied in the objective space.
- if one individual is feasible and the other non-feasible, the feasible individual dominates the non-feasible individual.

In this manner, Pareto ranking tournaments between individuals include the constraint minimization as well as the objective minimization. Note that in the case of the NSGA-II, for non-feasible individuals belonging to a given front in the constraint space, the computation of the I -distance density estimator is carried out in relation to all constraints [9]. In this way, niching will occur in the two different spaces (i.e. constraint and objective spaces) and diversity will be preserved to avoid premature convergence.

Five independent runs are performed to take into account the stochastic nature of the NSGA-II. The population size and the number of non-dominated individuals in the archive are set to 100 and the number of generations is $G=200$. Mutation and recombination operators are similar to those presented in [10]. They are used with a crossover probability of 1, a mutation rate on design variables of $1/m$ (m denoting here the total number of design variables in the problem) and a mutation probability of 5% for the X -gene parameter used in the self-adaptive recombination scheme. The surrogate sizing and simulation models described in the previous section are exploited to evaluate the constraints and the objectives (i.e. the useful power and the total wind turbine mass) related to each individual in the NSGA-II population.

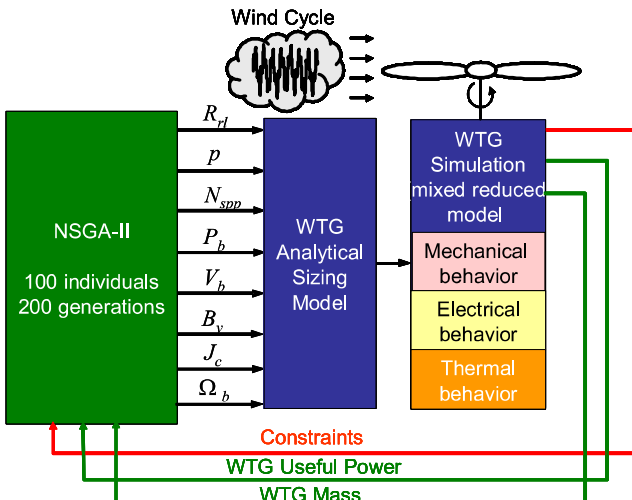

Fig.7 : The system optimization design process

IV WIND MODEL SYNTHESIS BASED ON STATISTICS

A. Particular time cycle based optimization

A particular time cycle of wind (S_{v_i}) can be firstly considered as typical of a given location as for the example in Fig.8 which is approximated by the following empiric relation (9):

$$V_w(t) = 10 + 0.2\sin(0.105t) + 2\sin(0.367t) + \sin(1.293t) + 0.2\sin(3.665t) \quad (9)$$

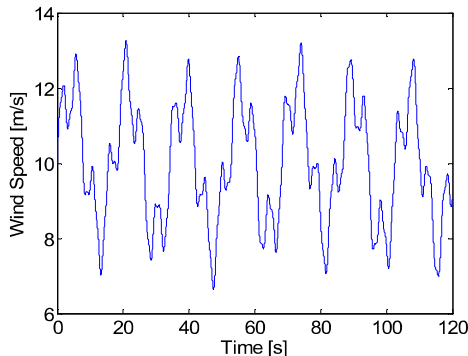

Fig.8 : A particular time cycle of wind (S_{v_i})

From this time cycle, the following optimization results are obtained and represented in the Pareto plan as on the power / speed plan (see Fig. 9). The Pareto plan illustrates the distance between the initial passive configuration (without MPPT) proposed in [4] and the set of the best tradeoffs.

Note that numerous individuals on the Pareto front dominate the initial configuration with a MPPT algorithm as proposed in [4], due to the additional losses in the DC-DC chopper of the corresponding “active structure”.

Four particular solutions are displayed on the power / speed plan showing the capability in terms of natural adaptation of the “full passive structure” with wind changes.

B. Signal generation from Mixed Weibull-turbulence statistic

Before generating the wind signal from statistics, it is interesting to make a frequency analysis of the wind system. Indeed, this analysis allows fixing the frequency range inside which the wind dynamic (turbulence) has an influence on the

system efficiency. For that purpose, a sinus wave is added to a constant wind speed:

$$V_w(t) = 10 + 3.\sin(2\pi ft) \quad (10)$$

This frequency analysis was made for several typical sizing solutions obtained in section IV.A, from the optimization process based on the particular time cycle. As for the particular solution N°1 represented in Fig.10, the power / frequency plan is composed of three different zones:

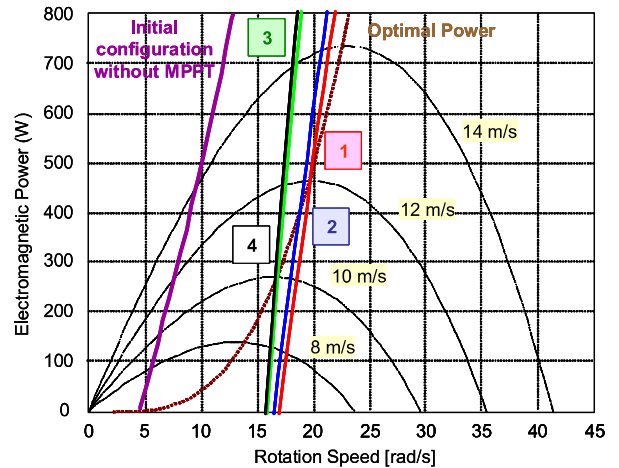
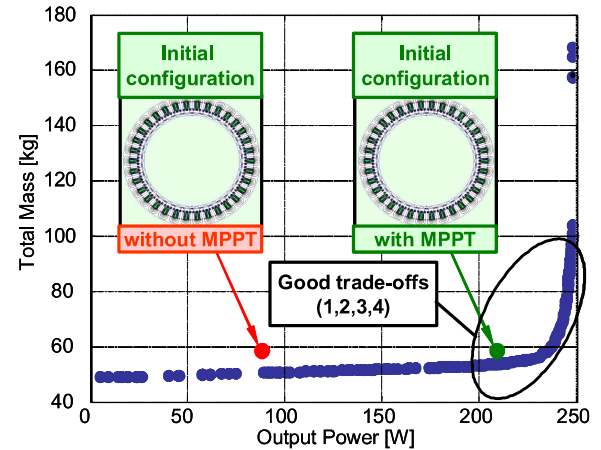

Fig.9 : Optimization results for a particular time cycle of wind

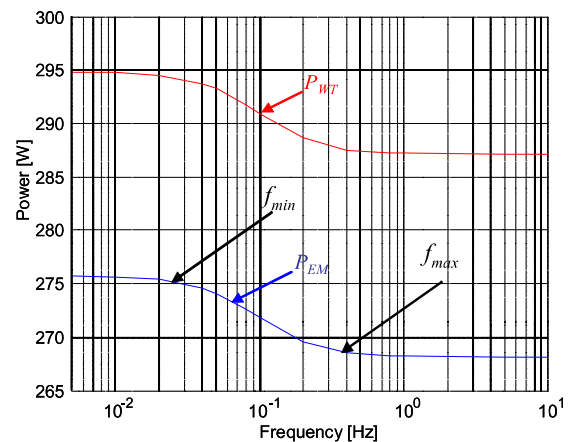

Fig.10 : Frequency analysis of input & output powers (solution 1)

- The low frequency range ($f < 40\text{mHz}$), where the extracted (input as output) powers remain constant whatever the frequency. In this range, with a slow wind variation, a quasi static system behavior is obtained;
 - The high frequency range ($f > 1\text{Hz}$), where the extracted (input as output) powers also remain constant whatever the frequency. Here, the turbine inertia filters the wind variations;
 - The intermediate frequency range inside which the extracted power varies with respect to the wind dynamic.
- It is important to note that, only the power level changes while the frequency range ($f_{\min} - f_{\max}$) remains constant whatever the sizing solution.

From this frequency analysis, it is possible to tune the parameters of the signal generation process in order to separate average values of wind speeds and turbulence components. Indeed, on the one hand, harmonics due to wind turbulence are only sensitive inside the frequency range ($f_{\min} - f_{\max}$). On the other hand, the variations of the average values must be generated with a frequency spectrum below the minimum frequency.

Statistics on the average values of wind speeds are classically based on the Weibull distribution [12] represented by the probability density function f and the cumulative distribution function F :

$$f(\bar{v}) = \frac{k}{c} \left(\frac{\bar{v}}{c}\right)^{k-1} \exp\left\{-\left(\frac{\bar{v}}{c}\right)^k\right\} \quad F(\bar{v}) = 1 - \exp\left\{-\left(\bar{v}/c\right)^k\right\} \quad (11)$$

where k is a dimensionless shape parameter, c (m/s) is the scaling factor and \bar{v} the average value of the wind speed.

Turbulence statistics of wind can be approximated by a Gaussian white noise with constant spectral density with a mean value μ (typically $\mu = 0$) and a variance σ_v^2 :

$$f(v) = \frac{1}{\sqrt{2\pi}\sigma_v} \exp\left(-\frac{(v-\mu)^2}{2\sigma_v^2}\right) \quad (12)$$

From these two statistical functions, the issue is to generate random sequences that fulfil the statistical properties i.e. that respect the f distribution laws. More details about random sequence generation are provided in [7] for any statistic function and in [13] for the particular case of a Gaussian function.

Finally, the wind generation process is described in Fig. 11. We have chosen to separate the wind speeds with two components: the average values \bar{v} and the turbulence Δv . Slow and fast dynamics are respectively sampled at T_e and t_e . based on the previous frequency analysis, we have chosen to sample both components as :

$$T_e = \frac{1}{f_{\min}} = 25 \text{ s} \quad ; \quad t_e = \frac{1}{f_{\max}} = 1 \text{ s}$$

From sampled signals, an interpolation with cubic B-splines functions allows generating continuous signals as in [7].

The accuracy and efficiency of this generation process depend on several factors as the number of samples or the interpolation function (linear, cubic, cubic B-splines): the cubic B-spline has been selected, being the most robust.

Fig.12 shows a comparison between the “theoretical” distributions from which a “simulation” can be generated.

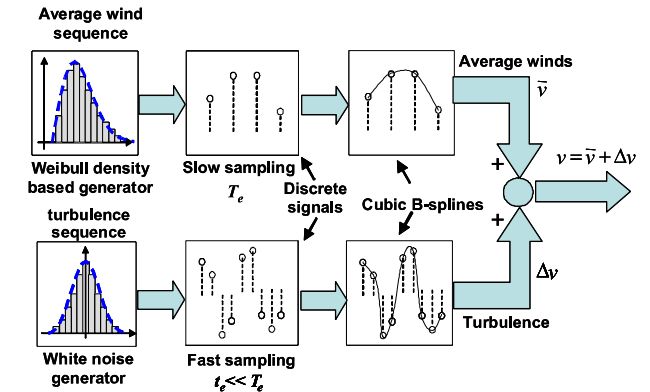

Fig.11 : Wind profile generation process from statistics

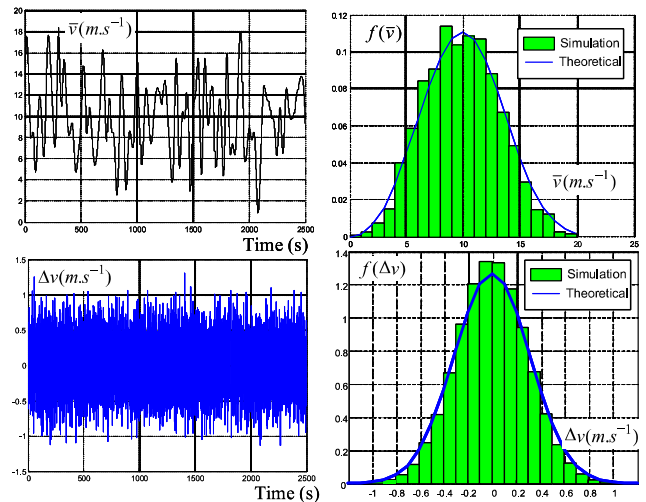

Fig.12 : Validation of typical wind components generated from statistics

V THE OPTIMIZATION ROBUSTNESS VS WIND

In order to characterize the robustness of the design process, the optimization results obtained from the particular wind cycle (see S_{v1} on Fig.8) are compared with the one obtained from the signal generator based on this mixed Weibull – Turbulence wind statistics (S_{v2}). The characteristics (min, max, mean value and cubic mean speeds) are summarized on Table 2. Note that, even if the mean speed values are nearly the same, the energetic content of both wind patterns differs as expressed by the cubic mean speed which is 30% greater for S_{v2} than for S_{v1} .

TABLE II: Characteristics of the generated wind signals

Signal	k, c, σ	v_{\min}	v_{\max}	$\bar{v} = \langle v \rangle$	$\langle v^3 \rangle$
S_{v1}	Eq. 9	6.64	13.26	10.00	1078.5
S_{v2}	9/3.2/0.1	0.37	18.82	9.84	1286.6

As presented in section III, a common optimization process is applied for both wind cycles with the system modeling of section II. Regarding the energetic content of each wind cycle, it is not surprising to find out a difference in the Pareto front. Indeed, for S_{v2} , the output power is greater than for S_{v1} . However, it is more typical to observe the robustness of the results. This can be done by comparing the solutions

optimized with a given profile (for example S_{v2}) with others optimized from the other wind pattern, for example S_{v1} , but simulated on the S_{v1} profile as presented in Fig.13. Although being optimized with two completely different wind patterns, both solutions are very close which put forward the optimal solution robustness in relation to wind cycles. This conclusion is confirmed by the results of Table 3 which compares the design variables obtained from both wind patterns for three particular solutions (1,2,3) in the Pareto plan (see Fig.13).

V. CONCLUSION

In this paper, authors have proposed a “low cost full passive structure” of a wind turbine system. An efficient operation of such device can be obtained only if design parameters are conveniently set from a system viewpoint. For that purpose, an optimization process has been presented and has proved its efficiency. In particular a wind profile generation process mixing Weibull and turbulence statistics has been defined. The optimization results are compared with those obtained from a particular but typical time cycle of wind speed and put forward the design robustness.

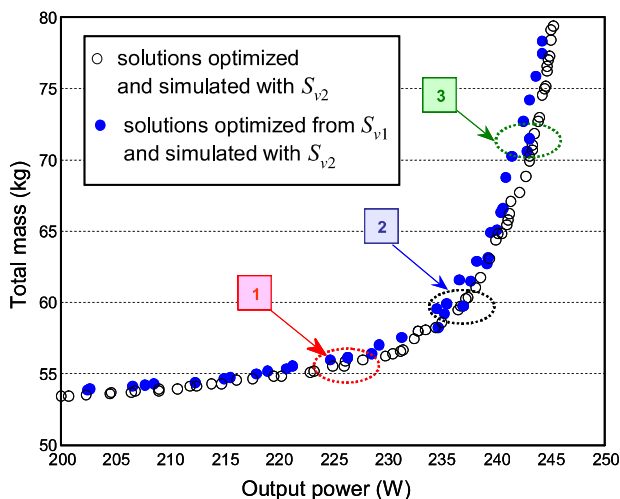

Fig.13 : Comparison of solutions optimized from S_{v1} & S_{v2} but both simulated on S_{v2}

TABLE III: Optimization parameters obtained from S_{v1} & S_{v2} for three particular solutions

Solution Parameters	1		2		3	
	S_{v1}	S_{v2}	S_{v1}	S_{v2}	S_{v1}	S_{v2}
B_v (Tesla)	1.9	1.9	1.9	1.9	1.49	1.39
J_s (A/mm ²)	4.99	5.0	4.83	4.92	3.49	3.38
N_{epp}	4	4	5	5	5	5
p	7	7	4	4	3	3
P_{dim} (W)	572	621	654	624	672	654.
R_{r1}	1.02	1.17	0.65	0.66	0.52	0.88
V_{dim} (V)	64.9	70.6	76.2	77.6	95.2	86
Ω_{dim} (rad/s)	17.9	18	17.5	16.8	16.6	17

VI. REFERENCES

- [1] A.M. De Broe, S. Drouillet, V. Gevorgian, “A peak power tracker for small wind turbines in battery charging applications”, *IEEE Transactions on energy conversion*, Vol 14, N°4, pp 1630-1635, December 1999
- [2] N. Stannard, J.R. Bumby, “Performance aspects of mains connected small scale wind turbines”, IET Generation, Transmission & Distribution (formerly IEE Proceedings), Vol. 1, Issue 2, pp 348–356, March 2007.
- [3] Z. Chen, S. Gomez, M. Mc Cormic, “a fuzzy logic controlled power electronic system for variable speed wind energy conversion systems, *Proceedings of Power Electronic & Variable Speed Drives*, IEE, publication N°475, pp 114-119, 2000.
- [4] A. Mirecki, X. Roboam, F. Richardeau, “Architecture cost and energy efficiency of small Wind Turbines : which system tradeoff?”, *IEEE Transactions on Industrial Electronics*, Vol 54, N°1, pp 660 – 670, February 2007.
- [5] O. Gergaud, B. Multon, H. Ben Ahmed, “modélisation d’une chaîne de conversion éolienne de petite puissance”, *Proceedings d’Electrotechnique du Futur 2001*, Nancy, nov. 2001, pp.17-22
- [6] A. Abdelli, B. Sareni, X. Roboam, “Optimization of a Small Passive Wind Turbine Generator with Multiobjective Genetic Algorithms”, *IJAEM (Intern Journal of Applied Electromagnetics)*, Vol. 26, N°3-4, pp. 175-182, 2007, selected from OIPE’06 conference
- [7] A. Abdelli, ‘Optimisation multicritères d’une chaîne éolienne passive’, Thèse de doctorat (PHD) de l’INP Toulouse, 15 Octobre 2007.
- [8] G. Slemon, X. Liu, Modeling and design optimization of permanent magnet motors, *Electrical Machines and Power Systems*, Vol. 20, 1992, pp. 71–92.
- [9] B. Sareni, J. Regnier, and X. Roboam, “Integrated Optimal Design of Heterogeneous Electrical Energetic Systems using Multiobjective Genetic Algorithms”, *IREE (International Review of Electrical Engineering)*, ISSN 1827-6600, Vol 1, N°1, pp. 112-129, 2006.
- [10] B. Sareni, J. Regnier, X. Roboam, Recombination and Self-Adaptation in Multi-objective Genetic Algorithms, *Lecture Notes in Computer Science*, Vol. 2936, 2004, pp. 115–126.
- [11] K. Deb, S. Agrawal, A. Pratab, T. Meyarivan, A fast elitist non-dominated sorting genetic algorithm for multiobjective optimization: NSGA-II, *Proceeding of the Parallel Problem Solving from Nature VI Conference*, Athens, Greece, 2000, pp. 849–858
- [12] J.K. Keller, "Simulation of Wind with 'K' Parameter", *Wind Engineering*, Vol. 16, No 6, p. 307-312, 1992.
- [13] G. E. P.Box, and , M. E. Muller, "a note on the generation of random normal deviates." *Ann. Math. Stat.* 29, 610-611, 1958.
- [14] E. Hoang, B. Multon, M. Gabsi, “Enhanced accuracy method for magnetic loss measurement in switched reluctance motor”, *ICEM’94*, 1994, Vol. 2, pp. 437-442.