



HAL
open science

Non destructive investigation of defects in composite structures by three infrared thermographic techniques

Elodie Péronnet, Marie-Laetitia Pastor, Richard Huillery, Olivier Dalverny, Sébastien Mistou, Hélène Weleman

► To cite this version:

Elodie Péronnet, Marie-Laetitia Pastor, Richard Huillery, Olivier Dalverny, Sébastien Mistou, et al.. Non destructive investigation of defects in composite structures by three infrared thermographic techniques. International conference on experimental mechanics ICEM 15, Jul 2012, Porto, Portugal. pp.0. hal-04041423

HAL Id: hal-04041423

<https://hal.science/hal-04041423>

Submitted on 22 Mar 2023

HAL is a multi-disciplinary open access archive for the deposit and dissemination of scientific research documents, whether they are published or not. The documents may come from teaching and research institutions in France or abroad, or from public or private research centers.

L'archive ouverte pluridisciplinaire **HAL**, est destinée au dépôt et à la diffusion de documents scientifiques de niveau recherche, publiés ou non, émanant des établissements d'enseignement et de recherche français ou étrangers, des laboratoires publics ou privés.



Open Archive Toulouse Archive Ouverte (OATAO)

OATAO is an open access repository that collects the work of Toulouse researchers and makes it freely available over the web where possible.

This is an author-deposited version published in: <http://oatao.univ-toulouse.fr/>
Eprints ID: 8861

To cite this version:

Péronnet, Elodie and Pastor, Marie-Laetitia and Huillery, Richard and Dalverny, Olivier and Mistou, Sebastien and Weleman, Hélène *Non destructive investigation of defects in composite structures by three infrared thermographic techniques.* (2012) In: International conference on experimental mechanics ICEM 15, 22-27 July 2012, Porto, Portugal.

Any correspondence concerning this service should be sent to the repository administrator: staff-oatao@listes-diff.inp-toulouse.fr

NON DESTRUCTIVE INVESTIGATION OF DEFECTS IN COMPOSITE STRUCTURES BY THREE INFRARED THERMOGRAPHIC TECHNIQUES

Elodie Péronnet¹, Marie-Laetitia Pastor^{2(*)}, Richard Huillery³, Olivier Dalverny¹, Sébastien Mistou^{1,4},
Hélène Welemene¹

¹PRES Université de Toulouse, INP, ENIT-LGP, 47 Av. Azereix, BP 1629, 65016 Tarbes Cedex, France

²PRES Université de Toulouse, UT3, IUT-ICA, 1 rue Lauréamont, BP 1624, 65016 Tarbes Cedex, France

³THERMOCONCEPT, Esplanade des Arts et Métiers, 33405 Talence Cedex, France

⁴NIMITECH ETUDES, 33 Av. du Général Leclerc 65200 Bagnères de Bigorre, France

(*)Email: marie-laetitia.pastor@iut-tarbes.fr

ABSTRACT

This paper investigates full-field measurement techniques based on Infrared Thermography for Non Destructive Testing (NDT) applications on composite materials. Three methods have been implemented and the paper intends to characterize and compare their defect detection limit and related specific application fields. Various composites have been considered in this study, namely laminates and sandwich structures, in order to address many important issues of performance assessment for the aviation industry.

Keywords: Non Destructive Testing, non-contact technique, full-field measurements, infrared thermography, sandwich and monolithic composite structure

INTRODUCTION

In order to achieve outstanding performance, it now seeks to optimize more and more the design and process of composite structures. Many applications require specific technical inspections at various steps of the product lifetime to assess their structural health. In such a context, NDT offer an interesting and appropriate tool for the analysis of structural parts, from manufacturing to service conditions.

For aviation industry, the AITM standards are precisely based on the NDT ultrasonic testing for the validation of composite structures. However, such technique is very restrictive in terms of used transducers and inspected part shape (local measurement technique). Accordingly, Infrared (IR) Thermography is more widely used in recent years for structural investigation: full-field measurements (global inspection), non-contact technique, fast execution and analysis (2D mapping in one shot) are significant benefits for this technique (Meola, 2006).

This work intends to characterize and to compare three different Infrared Thermographic techniques (IR, Lock-in IR and Pulse IR) on laminated and sandwich composite specimens with artificial defects. Such investigation allows to demonstrate the abilities of these NDT methods. Precisely, a specific attention is given to the following points:

- ✓ the defect detection limit, in order to know the equipment limits in relation with the critical defect size determined by aviation rules (namely 6 mm diameter),
- ✓ the specific material structures for each technique,
- ✓ their advantages and limitations for industrial applications.

INFRARED THERMOGRAPHIC TECHNIQUES

1. IR Thermography

The principle of the IR thermography is to send a heat flow on the surface of an inspected composite part during a certain time and then to capture the resulting thermal response. The sample is stimulated by a heat flow generated by halogen lamp with distribution that can be considered as square pulse stimulation and during a time depending on the material, its thickness and emissivity (Péronnet, 2010). The full-field measurement is carried out on the sample surface with an infrared camera leading in one shot to the film of the surface thermal mapping.

This technique can be used with two experimental configurations (Dattoma 2001; Péronnet 2010). On the one hand, the transmission setup consists in having the heat source on the opposite side of the camera; the measure obtained is then the heat flow which has passed through the material and which is perturbed by internal defects (Fig. 1). For the reflection device on the other hand, the heat source and the camera stand on the same side; the thermal mapping given by the camera corresponds therefore to the flow reflected by internal heterogeneities and the material surface which increases the measurement noise (Fig. 2). In both cases, the analysis of thermal mapping enables to highlight defects within the composite material (Fig. 3).

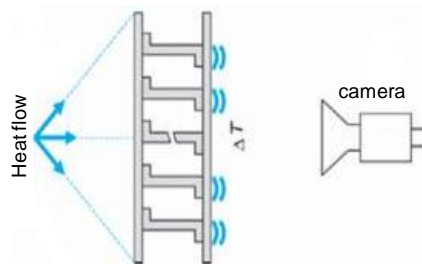

Fig. 1 : Transmission setup

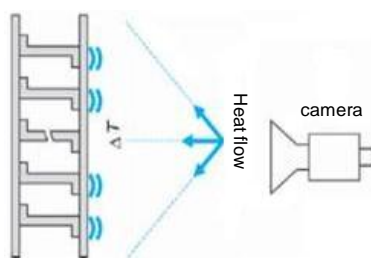

Fig. 2 : Reflection setup

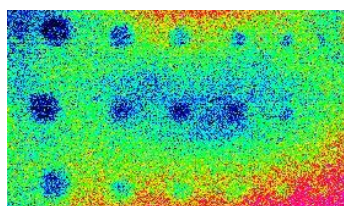

Fig. 3 : Thermal mapping provided by IR thermography

In our study, the following equipment has been used:

- 2 halogen lamps 120V 1000W,
- PULSAR signal amplifier,
- a CEDIP Infrared camera JADE retrofitted in FLIR Titanium (20 mK resolution, lens : MW 50 mm 2.0 Jade),
- ALTAIR software (for film capture and results visualization/analysis).

2. Lock-in IR Thermography

Lock-in IR thermography relies on the same methodology but is based on a different kind of thermal stimulation. Precisely, the heat source signal exhibits a sinusoidal form, whose wave frequency depends on the specimen thickness (Choi, 2008).

The electrical connection diagram of the Lock-in IR thermography is detailed on Fig. 4. The heat source signal parameters, namely the frequency and amplitude of the sinus function, are defined by means of the signal generator. At the same time, these data are provided to the IR camera in order to capture the module and the phase of the signal response.

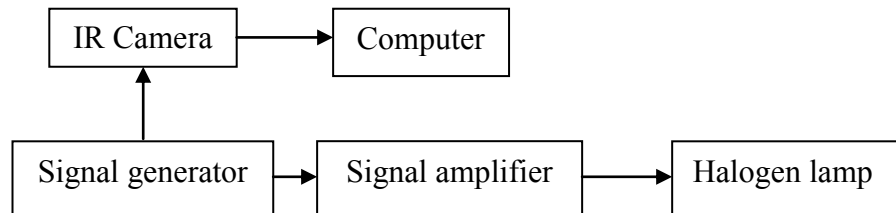

Fig. 4 : Connection diagram of Lock-in IR thermography

In addition to the previous ones, specific equipment has been needed for such methodology:

- HAMEG signal generator,
- ALTAIR LI software (for film capture).

Fig. 5 shows the experimental device used in the laboratory.



Fig. 5 : Lock-in IR thermography experimental device

3. Pulse IR Thermography

As before, Pulse IR thermography differs from the others by the type of excitation. A pulse excitation is sending to the inspected surface of the sample, the main advantage of this heating is to stimulate all the frequencies of the material during a very short time (Ibarra Castanedo, 2005). The evolution of the surface temperature is recorded by a camera (around 500 images) and a specific signal treatment, developed by Thermicar and I2M-TREFLE department, is

applied to obtain a physical 2D defect mapping relating to the thermal properties of the material.

To combine a full-field detector (IR camera) with a pulse heat excitation allows a quick control of large composites. For example, a multilayered composite of 2 mm can be controlled in 2 seconds.

Here the following equipment has been employed (Fig. 6):

- 2 flash lamps 230V 1500J,
- A FLIR Infrared camera SC7500 (20 mK resolution),
- ALTAIR software,
- THERMO-CND software (supplier : THERMOCONCEPT).

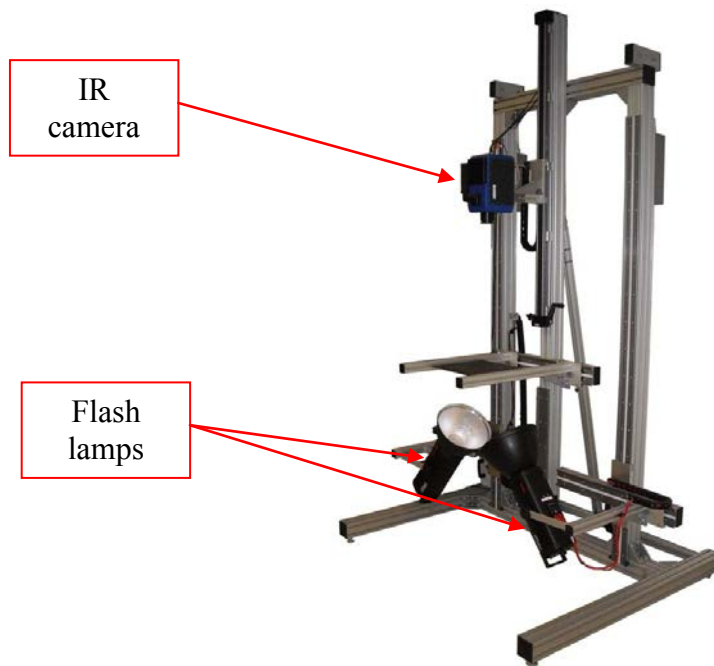

Fig. 6: Pulsed IR thermography experimental device

EXPERIMENTAL RESULTS

These three full-field measurement NDT have been implemented to investigate the internal defects of four kinds of composite samples (Fig. 7) :

- A. A carbon-epoxy laminated composite with flat-bottomed holes defects and variable thickness,
- B. A carbon-epoxy laminated composite including Teflon insert defects,
- C. A carbon-epoxy skins with foam-core sandwich composite including Teflon insert defects (skin thickness of 1.08 mm),
- D. A carbon-glass-epoxy skins with foam-core sandwich composite including Teflon insert defects (skin thickness of 0.66 mm).



Fig. 7 : Laminated and sandwich composite specimens

Artificial defects as small flat discs with different diameters (from 15 mm to 2 mm diameter) have been realized (flat-bottomed holes simulating porosities) or/and inserted (Teflon inserts simulating delamination) at various depths of each specimen in order to identify the detection limit of these techniques. For a better understanding, samples drawings of each kind of specimen are presented on Fig. 8 (type A), 9 (type B), 10 (type C) and 11 (type D).

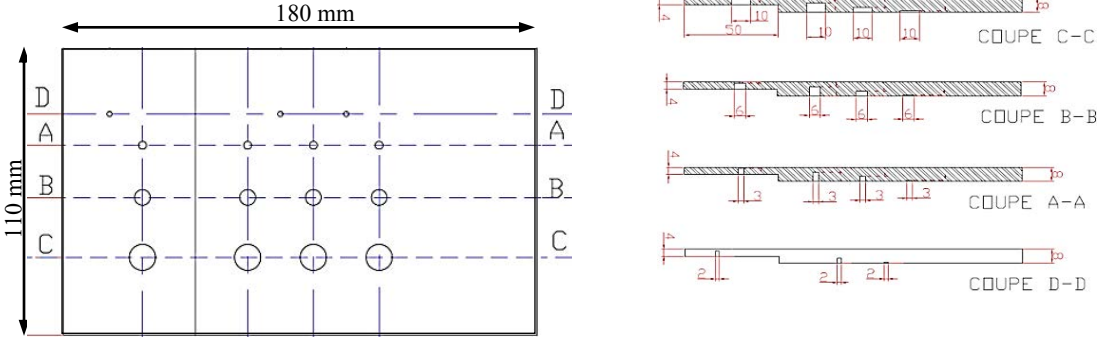

(a) Top view (b) Cross-sections
 Fig. 8 : Manufacturing drawing of Type A samples

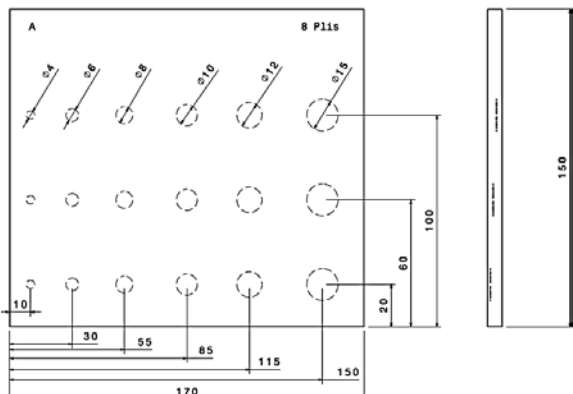

Fig. 9 : Manufacturing drawing of Type B samples

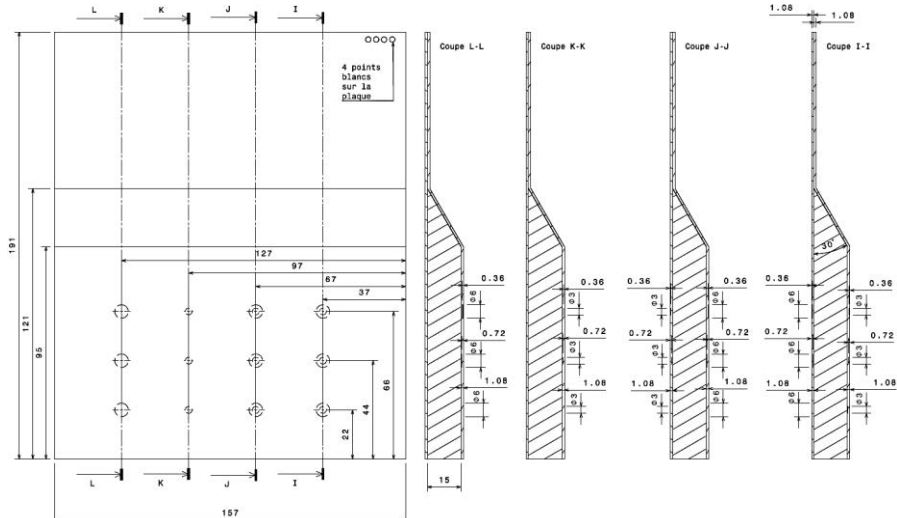

Fig. 10 : Manufacturing drawing of Type C samples

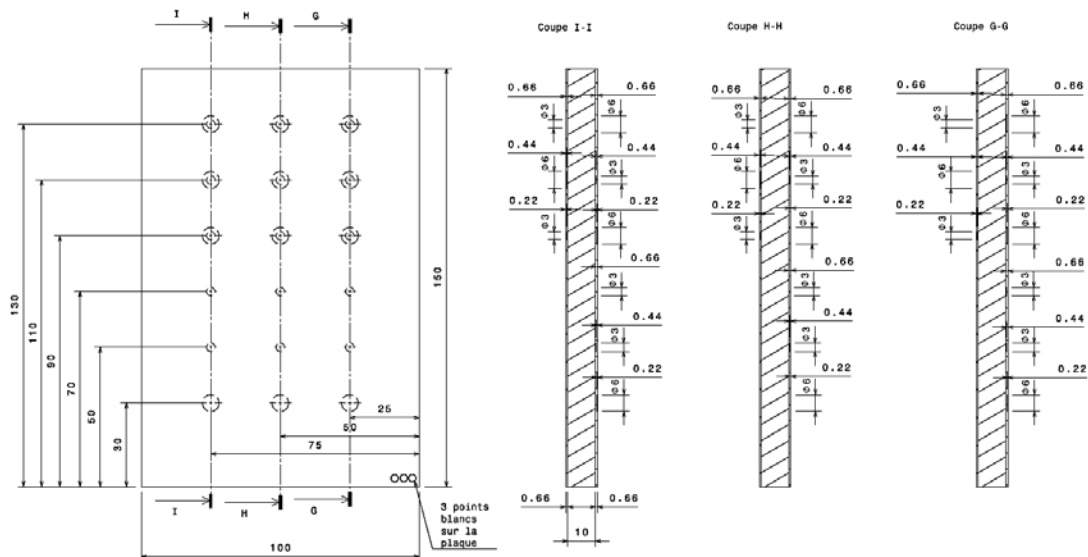

Fig. 11 : Manufacturing drawing of Type D samples

For all these specimens, the three full-field measurement methods based on Infrared Thermography have been applied. For each technique, the choice between transmission or reflection set-up has been done according to the considered material in order to get the best representation of heterogeneities. Table 1 provides a complete summary of the gray-scale results obtained during this investigation study.

Table 1. Thermal mappings according to NDT Infrared technique employed and material investigated

Specimens	IR thermography	Lock-in IR thermography	Pulse IR thermography
A 			
B 			
C 			
D 			

The study of A sample demonstrates the significant impact of the material thickness for infrared thermography. Indeed, the specimen exhibits a variable thickness (from 4 mm to 8 mm) and we can note a clear limitation of IR thermography and Pulse IR thermography over 4 mm thick (even with reflection setup). For Lock-in IR thermography, the use of a sinusoidal signal with low frequency (0.05Hz) allows to optimize the wave spread in the specimen thickness and provides better results with the detection of five defects with transmission setup. Concerning the 4 mm thick part, all the methods applied in transmission appear as powerful for aviation inspection (only the 2 mm diameter defects are not identified, which is much less than the limit of 6 mm required for reliable assessment). In this case, the Lock-in IR and the Pulse IR thermography seem more efficient for quantitative investigations since the defects outline can be more clearly distinguished. For such kind of material, the most accurate and powerful method is then the Lock-in IR thermography.

Results are quite similar between the three techniques in term of defect detection limit and precision for B specimen. Again, transmission methodology is used for such thin laminates (thickness less than 3 mm) and results clearly show the better identification of defects located closer to the camera. Between all the techniques, the Lock-in IR thermography leads to the best mapping quality since the choice of a low frequency signal allows reducing the measurement noise. Moreover, this technique is the only one able to capture the porosity on the specimen surface induced during the manufacturing phase.

Concerning foam-core composites (C and D samples), the use of infrared thermography is quite difficult since the foam is a thermal insulator. Precisely, one should rely in such case on the reflection methodology to control the two skins of the sandwich specimens. Each skin is inspected each in turn. Accordingly, the different defects are not as well detected as for A or B samples due to the large part of the noise measurement. We note that results for the D sample are better than for the C specimen, precisely concerning IR thermography and Lock-in IR thermography whereas the pulse IR thermography method have similar results for these two foam core composite structures and is the only one able to detect the majority of defects. In order to improve the result evaluation, we can make image processing which can delete the heat spot but may induce the loss of some important information such as the presence of small size defect. For such materials, the most accurate and efficient technique seems then to be the Pulse IR thermography thanks to a more powerful thermal source.

CONCLUSION

Thermography has allowed considerable progress for Non Destructive Testing in composite materials. This study intended to compare three methods based on such principle (IR, Lock-in IR and Pulse IR) on different kind of composite structures representative of aviation industry.

The three IR thermography methods presented in this work lead to quite similar results in terms of accuracy and efficiency concerning aviation industry monolithic composite part (2 mm or 3 mm of thickness). Above all, the Lock-in IR thermography with low frequency signal provides least noisy results.

For monolithic composite structure with bigger thickness (the range investigated is from 4 mm to 8 mm), the most suitable method is also the Lock-in IR since the optimization of the wave propagation allows a better crossing through the specimen.

Concerning foam core composite structure, the most accurate and efficient technique still remains the pulse IR thermography whose high power heat source manages to capture the material heterogeneities.

Soon, we will test more powerful halogen lamps in order to improve IR and Lock-in IR thermography results. The aim is to increase the heat flow to reduce the significant impact of the material thickness for infrared thermography and to obtain more clearly defects outline. These results allow us to apply image processing to size identified defects distinguishing clearly the image background, the measurement noise and small size defects.

REFERENCES

Choi M., Kang K., Park J., Kim W., Kim K., Quantitative determination of a subsurface defect of reference specimen by lock-in infrared thermography, *NDT&E International*, 2008, 41, p. 119–124.

Dattoma V., Marcuccio R., Pappalettere C., Smith G. M., Thermographic investigation of sandwich structure made of composite material, *NDT&E International*, 2001, 34, p. 515-520.

Ibarra Castanedo, C. Quantitative subsurface defect evaluation by pulsed phase thermography : depth retrieval with the phase, thesis, *LAVAL University*, QUEBEC, 2005.

Meola C., Carlomagno G. M., Squillace A., Vitiello A., Non-destructive evaluation of aerospace materials with lock-in thermography, *Engineering Failure Analysis*, 2006, 13, p. 380–388.

Péronnet E., Eyma F., Pastor M-L, Weleman H., Caractérisation et comparaison des limites de détection de techniques de contrôle non destructif : méthodes ultrasonores et méthodes optiques, *Conférence CMOI Toulouse*, 2010.