



HAL
open science

Refinements of the maximin approach to decision-making in fuzzy environment

Didier Dubois, H el ene Fargier, Henri Prade

► **To cite this version:**

Didier Dubois, H el ene Fargier, Henri Prade. Refinements of the maximin approach to decision-making in fuzzy environment. *Fuzzy Sets and Systems*, 1996, 81: Special issue Fuzzy Optimization (1), pp.103–122. 10.1016/0165-0114(95)00243-X . hal-04039810

HAL Id: hal-04039810

<https://hal.science/hal-04039810>

Submitted on 22 Mar 2023

HAL is a multi-disciplinary open access archive for the deposit and dissemination of scientific research documents, whether they are published or not. The documents may come from teaching and research institutions in France or abroad, or from public or private research centers.

L'archive ouverte pluridisciplinaire **HAL**, est destin ee au d ep ot et  a la diffusion de documents scientifiques de niveau recherche, publi es ou non,  emanant des  tablissements d'enseignement et de recherche fran ais ou  trangers, des laboratoires publics ou priv es.

Refinements of the maximin approach to decision-making in fuzzy environment

Didier DUBOIS – H el ene FARGIER – Henri PRADE

Institut de Recherche en Informatique de Toulouse (I.R.I.T.) – CNRS

Universit  Paul Sabatier, 118 route de Narbonne

31062 Toulouse Cedex – France

Tel.: (+33) 61.55.69.42 – Fax: (+33) 61.55.62.39

Email: {dubois, fargier, prade}@irit.fr

ABSTRACT: The most popular approach to decision-making in the setting of fuzzy sets is the maximin ranking of solutions. This method is natural when interpreting the fuzzy sets as flexible constraints that cannot compensate with one another. However the obtained ranking of solutions is very coarse. Two kinds of refinements to this ordering are introduced: a partial ordering according to the least satisfied discriminating constraint, and a lexicographical ranking. The latter refines the former and combines utilitarian and egalitarian points of view on the aggregation of feasibility degrees. These orderings are characterized in several ways and their representation by means of two place numerical functions is studied. Dual refinements of the maximax ranking are provided.

KEY-WORDS: Fuzzy constraints, maximin problems, vector-maximization, partial ordering, leximin ordering.

1. Introduction

In their seminal paper, Bellman and Zadeh [2] established a link between fuzzy set theory and multiple criteria decision-making. The basic idea is that the set of good solutions according to a criterion is a fuzzy set, and that the set of optimal solutions is obtained by means of the intersection of these fuzzy sets. More recently, Dubois, Fargier and Prade [9] have pointed out that this maximin paradigm for fuzzy optimization actually models flexible constraints, rather than objective functions. Indeed, the characteristic property of a constraint, namely it cannot be violated, still applies to the maximin approach to fuzzy optimization. Any solution with zero membership grade for a single constraint is rejected as impossible. No compensation between partial satisfaction levels is allowed. On the contrary, the tradition of multiple criteria decision-making is based on the idea of trade-off (e.g., Keeney and Raiffa [24]): the point is that a bad local degree of satisfaction for a criterion can be compensated by a good partial satisfaction level for another criterion. This is not the case in the maximin approach, in which the global satisfaction level for a solution to a set of fuzzy constraints is the level of satisfaction of the least satisfied constraint.

The authors have previously noticed that the calculus of fuzzy restrictions introduced by Zadeh [34] can be used as a tool for flexible constraint propagation [9, 10].

The main merit of the maximin paradigm of fuzzy optimization is that almost all classical constraints propagation techniques developed in Artificial Intelligence (e.g., arc and path consistency algorithms (Montanari [27], Mackworth [26]) carry over to the setting of flexible constraint propagation. The main defect of the maximin approach is its lack of discrimination power between solutions that strongly differ with respect to the fulfilment of membership to the various constraints, except for the smallest membership grades.

This paper proposes various techniques for refining the min-based ordering of solutions that cope with this defect. The first improvement (Section 3) consists in deleting flexible constraints which do not discriminate among maximin solutions, and considering maximin solutions to the set of remaining constraints. The second improvement (Section 4), which further refines the first one, focuses on the number of flexible constraints satisfied to a given degree, and leads to a lexicographic ordering of the maximin solutions. This ordering is known in the literature of social choice under the name of "leximin" (e.g., Moulin, [29]). These definitions of optimality are compared to the standard Pareto ordering of vector-maximization. Dual notions refining maximax solutions are also defined and studied (Section 5). Relationships between these concepts of optimality, fuzzy set inclusion and fuzzy cardinality are also established. The next section discusses the difference between an objective and a fuzzy constraint. The contents of this paper are based on results that appear in the second author's Ph.D. thesis (Fargier [19]); some of these results have been presented earlier by Fargier et al. [18].

2. Multiple objective decision-making versus fuzzy constraints satisfaction

The notion of constraint is widely used in many decision making problems : design, planning, scheduling, etc. A constraint describes what are the potentially acceptable decisions (the solutions) and what are the absolutely unacceptable ones : it is an all-or-nothing matter. Moreover, no constraint can be violated. The idea of an objective is quite different : attaining an objective is a matter of degree and leads to introducing a preference ordering on the the solutions; moreover, in the presence of multiple conflicting objectives, trade-offs are allowed.

2.1 Objectives versus fuzzy constraints

An objective function g_i associates to each solution s_u to a problem a value $g_i(s_u)$ in a totally ordered set $\langle L, \leq \rangle$ (for instance, $L = [0,1]$ or $L = [0, + \infty)$). The best solutions according to g_i are those maximising $g_i(s_u)$. In other terms, g_i induces a complete pre-order \leq_{g_i} on the set of feasible solutions (a complete, reflexive and transitive relation) defined by : $s_u \leq_{g_i} s_v$ if and only if $g_i(s_u) \leq g_i(s_v)$; this will be interpreted by "the criterion g_i prefers s_v to s_u ". However, there is not necessarily thresholds $a < b$ such

that below a a solution is rejected whatever its ratings for other criteria, nor such that above b the objective is totally fulfilled.

A classical hard constraint is represented by a classical set, i. e., only using two satisfaction levels 0 or 1. The notion of fuzzy constraint as introduced by Bellman and Zadeh [2] meant to represent constraints as well as objectives by fuzzy subsets C_i of S , the set of possible decisions,

$$\begin{aligned} \mu_{C_i} : S &\rightarrow L = [0,1] \\ s_u \in S &\mapsto \mu_{C_i}(s_u) = u_i \in [0,1] \end{aligned}$$

Viewed as a constraint, C_i is called a fuzzy constraint : $\mu_{C_i}(s_u) = 1$ means that s_u totally satisfies C_i while $\mu_{C_i}(s_u) = 0$ means that it totally violates C_i (s_u is unfeasible). If $0 < \mu_{C_i}(s_u) < 1$, s_u satisfies C_i only partially ; $\mu_{C_i}(s_u) < \mu_{C_i}(s_v)$ indicates that C_i is more satisfied by s_v than by s_u (C_i prefers s_v to s_u). Hence, like an objective function, a fuzzy constraint rank-orders the feasible decisions. However, contrary to an objective function a fuzzy constraint also models a threshold below which a solution will be rejected and a threshold above which solutions are just equally feasible. In fact, a fuzzy constraint can be viewed as the association of a constraint (defining the support of C_i) and a criterion which rank-orders the feasible solutions according to preference.

Remark : using fuzzy constraints to represent priorities

Constraints are understood as imperative. However, Dubois, Fargier and Prade [9] have shown that fuzzy constraints can also handle the notion of priority, in accordance with early attempts at coping with antagonistic constraints, for instance the work of Descottes and Latombe [8]. Priorities will be represented by means of levels in the scale $[0,1]$: a coefficient p_i is attached to a crisp constraint C_i and called its priority degree. If $p_i = 1$, C_i is an imperative constraint; if $p_i = 0$, it is completely possible to violate C_i (C_i has no incidence in the problem); $p_i > p_j$ means that the satisfaction of C_i is more necessary than the satisfaction of C_j : if C_i and C_j cannot be satisfied simultaneously, solutions compatible with C_i only are preferable to solutions compatible with C_j only.

Priorities on constraints can be transformed, without any loss of information, into satisfaction degrees on values. Indeed, since p_i represents to what extent it is necessary to satisfy C_i , $1 - p_i$ indicates to what extent it is possible to violate it. In other words, any potential decision u satisfies C_i to a degree greater than or equal to $1 - p_i$. Hence, the pair (C_i, p_i) , where C_i is a crisp constraint, can be modelled as a fuzzy constraint C'_i :

$$\begin{aligned} \mu_{C'_i}(s_u) &= 1 \text{ if } s_u \text{ satisfies } C_i \\ &= 1 - p_i \text{ if } s_u \text{ violates } C_i. \end{aligned}$$

If C_i is itself a soft constraint with priority p_i , it will be modelled by the fuzzy constraint C'_i : $\mu_{C'_i}(s_u) = \max(1-p_i, \mu_{C_i}(s_u))$. These definitions, originally due to Yager [32], make sense on any ordinal scale equipped with an order-reversing map, and are in accordance with the treatment of certainty-qualified assertions in possibility theory (Dubois and Prade [15]), and the principle of minimum specificity, interpreting priority levels as necessity degrees. When constraints are crisp, they are in full agreement with possibilistic logic (Lang [25]; Schiex [31]; Dubois, Lang and Prade [13]). This treatment of prioritized constraints relies on the assumption that it is not possible to fully violate a constraint that is not imperative. As a consequence priority weights can only decrease the importance of constraints, since, when no weight is attached, constraints are considered as imperative. The setting of possibility theory suggests that fuzzy constraints subsume prioritized constraints.

2. 2 Pareto-optimal solutions

A multi-criteria decision problem typically involves a set of n criteria. The question is to determine the best decision in the set of all feasible decisions (say, S) according to several objectives. More generally, we have to build a (partial) ordering on S from different rankings. The comparison between solutions can be expressed in terms of comparison of *utility vectors*, where each component represents the rating of a solution with respect to an objective function. The vector of satisfaction levels of a solution s_u will be denoted $\vec{u} = (u_1, \dots, u_n)$ with $u_i = g_i(s_u) \forall i$. In terms of fuzzy constraints, the notion of utility vector corresponds to the (fuzzy) set of constraints satisfied by a solution. Let us denote by $\mathcal{C} = \{C_1, \dots, C_n\}$ the set of fuzzy constraints involved in a decision problem. The set of constraints satisfied by a solution s_u , noticed \mathcal{S}_u , is the fuzzy subset of \mathcal{C} defined by :

$$\begin{aligned} \mu_{\mathcal{S}_u}: \mathcal{C} &\rightarrow L = [0,1] \\ C_i \in \mathcal{C} &\mapsto \mu_{\mathcal{S}_u}(C_i) = u_i = \mu_{C_i}(s_u) \in [0,1]. \end{aligned}$$

In other words, the utility vector \vec{u} corresponding to s_u provides the same information as \mathcal{S}_u . In the following, we shall not distinguish between solutions that have exactly the same rating according to all objective functions, or fuzzy constraints. Also by convention we shall suppose that the rating scales are all identical to the unit interval. Hence *the problem is to find a suitable ordering over a subset U of $[0,1]^n$* where n is the number of criteria or fuzzy constraints involved in the problem.

Social choice theory proposes a wide variety of decision rules like the majority rule, the unanimity rule, etc..., depending on some conditions like unanimity, non-dictatorship or independence of irrelevant alternatives. These properties have been applied to fuzzy sets by Fung and Fu [22], Cholewa[6], Montero de Juan [28], Yager, [33], Dubois and Koning [11] among others. Social choice theory traditionally considers so-called social welfare orderings (SWO); see for instance (Moulin [29]) : a SWO is a

preordering on S (or, equivalently, on $[0,1]^n$). A SWO M can be defined by a preference relation $>_M$ and an indifference relation \approx_M . Moulin [29] assumes that a SWO satisfies two additional properties :

(a) Anonymity : if \vec{u} can be obtained from \vec{v} by exchanging coordinates, $\vec{u} \approx_M \vec{v}$.

(b) Unanimity (weak Pareto principle) : if $u_i \geq v_i$ for $i = 1, n$, then $\vec{u} \succcurlyeq_M \vec{v}$.

Moreover, if $u_i > v_i$ for $i = 1, n$, then $\vec{u} \succ_M \vec{v}$.

Anonymity presupposes that each individual constraint is equally important. Intuitively, the unanimity principle means that if all criteria rate decision s_u better than decision s_v , decision s_v should not be considered. The most elementary and least demanding SWO is the Pareto ordering (denoted by $\succcurlyeq_{\text{Pareto}}$), which is a well-known quasi-order defined by :

- $\vec{u} \succ_{\text{Pareto}} \vec{v}$ if and only if $\forall C_i, u_i \geq v_i$ and $\vec{u} \neq \vec{v}$;
- $\vec{u} \approx_{\text{Pareto}} \vec{v}$ if and only if $\forall C_i, u_i = v_i$ or $\exists C_i, C_j$ such that $u_i > v_i$ and $u_j < v_j$.

Denoting S the set of potential decisions, the Pareto optimality condition can be expressed as :

- s_u is Pareto-optimal if and only if there is no $s_v \in S$ such that $\vec{u} \neq \vec{v}$ and $u_i \leq v_i$ for $i=1,n$.

A Pareto-optimal decision s_u is such that, for any other decision s_v , if there is a criterion preferring s_v to s_u , then there is another one that prefers s_u to s_v . Clearly, \succ_{Pareto} is a strict partial order : many optimal decisions can be incomparable. In terms of fuzzy sets, *the Pareto principle corresponds to a fuzzy set inclusion*. Indeed :

$$\vec{u} \succ_{\text{Pareto}} \vec{v} \iff \mathcal{S}_v \subset \mathcal{S}_u$$

where \subset stands for the fuzzy set inclusion. So, the larger the set of constraints satisfied by a solution, the better this solution. The Pareto-optimal decisions correspond to vectors \vec{u} such that there is no \vec{v} such that $\mathcal{S}_u \subset \mathcal{S}_v$.

When $\vec{u} \approx_{\text{Pareto}} \vec{v}$ and corresponding decisions satisfy the same fuzzy set of constraints ($\mathcal{S}_v = \mathcal{S}_u$, i.e., $\vec{u} = \vec{v}$) they are indifferent. Otherwise, the relation \approx_{Pareto} rather models incomparability. Notice that it is not transitive.

2.3 Egalitarianism versus utilitarianism

To select among Pareto-optimal solutions in S , we have to build a more selective global pre-order on S from the different utility vectors. Our claim is that this preorder will depend upon whether each C_i is really as imperative as a constraint, i.e., whether it is not allowed to violate it, or if C_i is just describing an objective function among other ones.

In some cases, the global ranking can be represented by a collective utility function (CUF), i. e. a real valued function W on the vectors. In this case, \vec{u} will be preferred to

\vec{v} according to W ($\vec{u} >_W \vec{v}$) if and only if $W(\vec{u}) > W(\vec{v})$. Similarly, \vec{u} and \vec{v} are equivalent ($\vec{u} \approx_W \vec{v}$) if and only if $W(\vec{u}) = W(\vec{v})$. CUF are supposed to satisfy the properties of anonymity and unanimity.

Two particular classes of CUF are usually pointed out in social choice theory: the utilitarian ones and the egalitarian ones.

2.3.1 Utilitarian approaches for compensatory objectives

The utilitarian approaches refer to additive CUF (sums, averages, products). $W(\vec{u}) = \sum_{i=1,n} u_i$ represents the cost of a decision and the best decisions are those maximizing W . In that case, u_i is understood as a financial reward. Notice that the Σ -optimal solutions are Pareto-optimal : this utilitarian ordering is a refinement of the Pareto ordering.

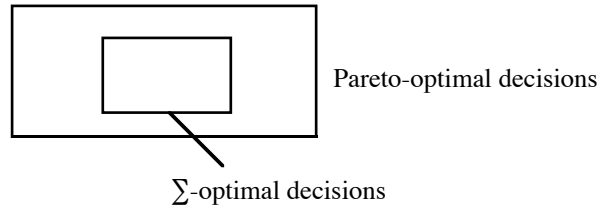

Figure 1

A utilitarian CUF models a compensation between well-satisfied criteria and less satisfied ones. Note that if $L = \{0,1\}$, i.e., if the objectives can only be totally satisfied or violated (no partial satisfaction), utilitarian solutions will be those which maximise the number of attained objectives (Freuder [20]; Freuder and Wallace, [21]). In extreme cases, it can lead to decisions totally missing some objectives.

2.3.2 Egalitarian approaches for imperative constraints

The egalitarian approaches are more qualitative. Utilities are combined using a minimum or a maximum operation, which do not induce any compensatory effect.

For instance, each constraint estimates to what extent the decisions satisfy some security regulations : $W(\vec{u}) = \min_{i=1,n} u_i$ indicates to what extent s_u is a safe solution; we recognize here Bellman and Zadeh's approach to decision making : the best decisions, also called *maximin decisions*, are those maximizing the satisfaction degree of the least satisfied constraint. As they notice, the global ordering over S is a complete preorder which corresponds to a fuzzy set C :

$$\begin{aligned} \mu_C : \quad S &\rightarrow L = [0,1] \\ s_u \in S &\mapsto \mu_C(s_u) = \min_{i=1,n} \mu_{C_i}(s_u) \end{aligned}$$

That is to say, C is nothing but the fuzzy set corresponding to the intersection of the fuzzy constraints : $C = C_1 \cap \dots \cap C_n$. As shown by Dubois, Fargier and Prade [9,10], $\mathcal{C} = \{C_1, \dots, C_n\}$ defines a fuzzy constraint satisfaction problem (FCSP) whose best

solutions can be found using extensions of classical CSP methods. Adopting the possibilistic approach to prioritized constraints as explained in the previous section, the egalitarian approach comes down to minimizing the priority of the violated constraint which is the most priority, a strategy used by Descottes and Latombe [8] and refined by them.

In terms of social choice, the min-ordering corresponds to a society where every member has a veto power. On the contrary, $W(\vec{u}) = \max_{i=1,n} u_i$ corresponds to a society where every member is a dictator. Notice that some authors (see for instance [5]) propose to deal with symbolic preferences, instead of numerical ones. In fact, these approaches are equivalent to numerical egalitarian approaches (maximin) which are more qualitative than quantitative.

2.4 Drawbacks of utilitarian and egalitarian approaches for handling fuzzy constraints

Using a satisfaction rating on $[0,1]$ the difference between a fuzzy constraint and an objective function pertaining to a criterion seems to vanish. And indeed, tradition assumes that a constraint is hard, by definition. However the difference between a set of fuzzy constraints and a set of objective functions really makes sense if we consider the two modes of aggregations, i.e., egalitarian and utilitarian. The egalitarian approach preserves a basic property of a set of constraints, that is : any solution violating a single constraint is considered as not feasible. On the contrary, a best solution in the utilitarian sense is allowed to get a 0 on one (or several) of the ratings, although utilitarian best solutions are always Pareto-optimal. This is not acceptable in terms of constraints, even fuzzy ones. Hence, Bellman and Zadeh's paradigm for fuzzy optimization [2] is really one of decision under flexible constraints. Given the non-compensatory property of fuzzy constraints, while objective functions do admit compensations, it is not clear that, in a given decision-making problem, an objective function can be made commensurate to the membership function of a fuzzy constraint¹. Due to their imperativeness, fuzzy constraints, even the less important ones, should always have priority over objective functions and one should refrain from aggregating a degree of feasibility with a degree of preference (in the sense of an objective function) (see Dubois and Prade [17]).

¹ In fact it is possible to reconcile compensation and fuzzy constraints, changing the minimum into a product. Clearly this is equivalent to a utilitarian approach where the utilities can take on the value $-\infty$, using a logarithmic transformation. However this approach, as does the utilitarian approach, requires that the set of constraints be non-redundant, a condition that is not easy to achieve in practice, and which is not at all requested by the egalitarian CUF.

Example 1.

Assume you have to dispatch 100 KF between 3 persons. The satisfaction of each person is the proportion of the budget it will receive. It is clear that every partitioning of the budget is Pareto-optimal, and Σ -optimal. There is only one maximin decision : giving the third of the 100 KF to each person. There are 3 maximax decisions : giving the totality of the 100 KF to one single person.

Suppose that the dispatching of the money should satisfy the fuzzy constraint "everybody should have some money". This problem can be represented by means of 3 fuzzy constraints C_i , where $\mu_{C_i}(x) = x / 100$ measures the level of satisfaction of the constraint C_i pertaining to individual i . Since any decision is optimal from an utilitarian point of view, it is clear that some of them violate two constraints over three (the maximax solutions). This example shows that the utilitarian approach is not adapted to the handling of fuzzy constraints.

Another drawback of the utilitarian approaches is that they do not lend themselves easily to a generalization of classical constraint propagation techniques. On the contrary the min-based aggregation is associative and idempotent, as the conjunction in the Boolean case, and as pointed out earlier, all the methods developed for constraint propagation in Artificial Intelligence carry over to the maximin setting : this is the calculus of fuzzy restrictions (Zadeh [34]).

The egalitarian approach also has some drawbacks. First, it is worth noticing that the min-ordering satisfies the weak Pareto principle but not strong Pareto optimality. Consider for instance $S = \{s_u, s_v\}$, the corresponding utility vector being $\vec{u} = (0.3 \ 0.3 \ 0.4)$, $\vec{v} = (0.3 \ 1 \ 1)$ according to a set of 3 criteria. Then $\vec{u} \approx_{\min} \vec{v}$ although $\vec{u} <_{\text{Pareto}} \vec{v}$: \vec{u} and \vec{v} are paradoxically judged equivalent although \vec{u} and \vec{v} being equivalent for the first criterion and \vec{v} being much better for the others. Nevertheless, the weak Pareto condition is verified :

$$\text{if } u_i \geq v_i \text{ for } i = 1, n, \text{ then } \vec{u} \succ_{\min} \vec{v}$$

The same criticisms can be formulated against the max-ordering (see Figure 2).

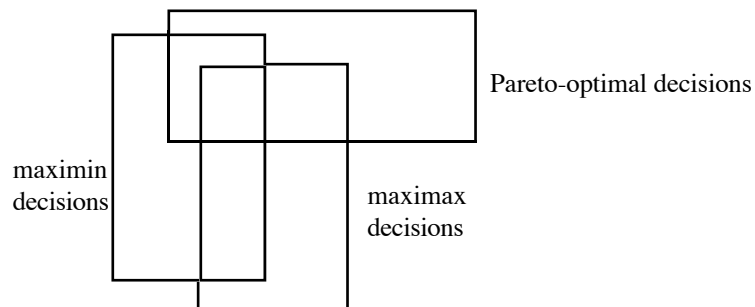

Figure 2.

Note that it may happen that some maximax decisions are also maximin ones, but it is not always the case. On the other hand, there is always a subset of the maximin decisions which are Pareto-optimal and a subset of the maximax decisions which are Pareto-optimal.

A second drawback of the egalitarian approach is its lack of discrimination power. In order to keep the egalitarian aspect of min, to increase the discrimination among solutions and to satisfy Pareto-optimality which is intuitive, our aim is to define suitable refinements of these orderings.

Example 2.

Assume that a tutorial course is to be organized. Ideally, it should be composed of less than 8 sessions (possibly 9 which is less acceptable, or at most 10). Prof. A, who will give the training part of the tutorial, wants to have exactly 3 sessions (imperative constraint). Ideally, pedagogical principles require that there must be more lecture sessions than training sessions (ideally the difference must be equal or greater than 2 sessions, possibly equal to 1, or equal to 0 in the least acceptable case). Moreover, there must be the same number of lectures as exercise sessions (ideally, exactly the same number; a difference of 1 session is “half-acceptable”, a difference of 2 being the maximal acceptable difference). This problem can be modelled as follows:

x = number of lectures y = number of exercise sessions

z = number of training sessions = 3

$C_1: x + y + 3 \in (-\infty, \text{About}_8]$ $C_2: x - 3 \in [\text{About}_2, +\infty)$ $C_3: |x - y| \in \text{About}_0$

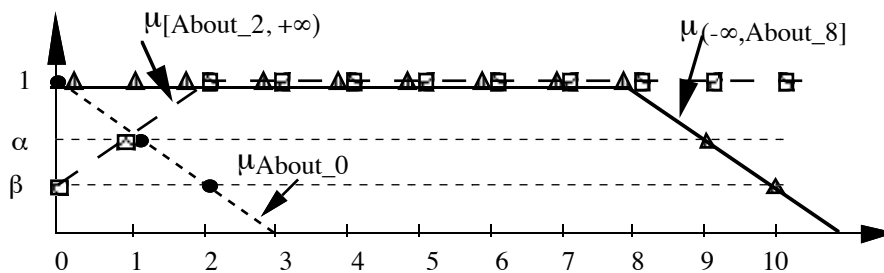

Figure 3

There are 6 maximin decisions (x, y) : $s_1 = (3, 1)$, $s_2 = (3, 2)$, $s_3 = (3, 3)$, $s_4 = (3, 4)$, $s_5 = (4, 2)$ and $s_6 = (4, 3)$. For each of them, the satisfaction degree of the least satisfied C_i is β ; see Figure 4.

It is clear that it is not very reasonable not to discriminate between these solutions, since, for instance, s_2 satisfies the first two constraint to the same degree as s_1 but is better for C_3 : the former should be preferred to s_1 .

Some of these maximin decisions are Pareto-optimal : s_2 , s_3 , s_5 and s_6 ; but there are Pareto-optimal decisions which are not maximin, for instance : (5, 6) whose utility vector is $(0, 1, \alpha)$.

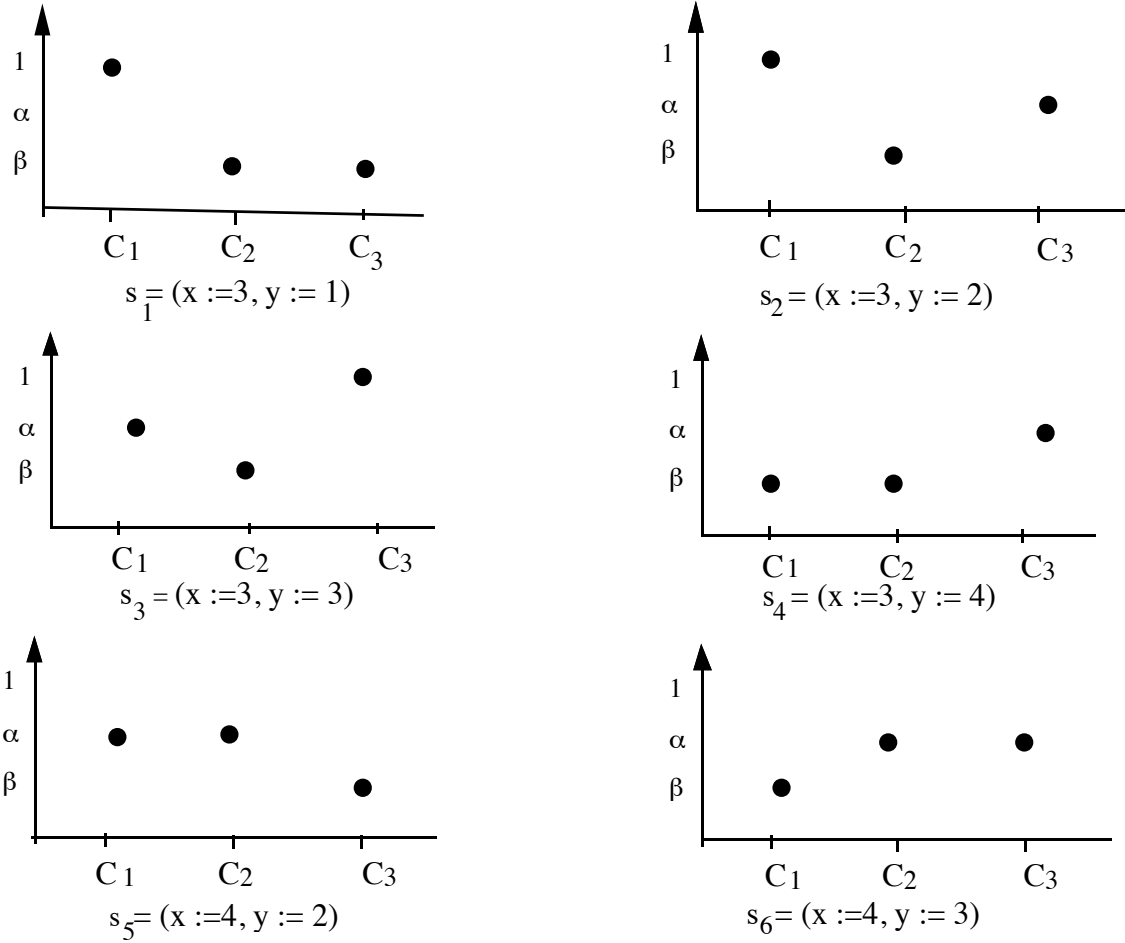

Figure 4

Notice that these orders do not depend on the values of α and β : $L = \{0, \alpha, \beta, 1\}$ is used as an ordinal scale rather than a cardinal one. This is not the case using the utilitarian ordering : as soon as $\alpha + \beta < 1$, all Σ -optimal decisions have a CUF equal to 2 (they totally violate one constraint and completely satisfy the 2 others) ; for instance (5, 5) is Σ -optimal if we assume $\alpha + \beta < 1$. Let us point out the fact that these Σ -optimal decisions totally violate a constraint. If $\alpha + \beta \geq 1$, the Σ -optimal decisions are completely different (s_2 and s_3) ; they are among the maximin decisions. In this case, the sum of the satisfaction degree is $1 + \alpha + \beta \geq 2$.

3. Refining the min- ordering : the least satisfied discriminating constraint

As shown previously, the Pareto ordering, which corresponds to the notion of fuzzy-sets inclusion, is not a refinement of the min-ordering. Keeping in mind this idea of inclusion, we propose to define a refinement of both these orderings by

comparing the decisions on the basis of level-cut inclusion. Hence, we get a new ordering (a new preference relation), $>_{\text{LSDC}}$; as we will show in the next sections, this ordering is also based on the comparison of the Least Satisfied Discriminating Constraint (LSDC), as first hinted by Fargier et al. [18], i.e., it also refines the min-ordering, thus improving its discrimination power.

3.1 The LSDC-ordering.

The idea of this refinement is to compare satisfaction degrees pointwise like in $>_{\text{Pareto}}$, and to focus on the lowest satisfaction degrees among the constraints satisfied *at different degrees* by the competing decisions : decisions are compared on the basis of the least satisfied *discriminating* constraints. This seems to be in accordance with the intuition, since only the constraints making a difference between two alternatives can help make a final decision. To wit, in example 2 of the previous section, solution s_2 with $\vec{u}_2 = (1, \beta, \alpha)$ is better than solution s_1 with $\vec{u}_1 = (1, \beta, \beta)$, because only constraint C_3 discriminates between these solutions.

Let us denote by $\mathcal{D}(u, v)$ the set of constraints which are satisfied by s_u and s_v to different levels : $\mathcal{D}(u, v) = \{C_i \in \mathcal{C} / u_i \neq v_i\}$. A definition of $>_{\text{LSDC}}$ has been proposed by Fargier et al. [18] :

$$\vec{u} >_{\text{LSDC}} \vec{v} \Leftrightarrow \text{Min}_{C_i \in \mathcal{D}(u, v)} u_i > \text{Min}_{C_i \in \mathcal{D}(u, v)} v_i.$$

In the following, we suppose that S is finite, and so is also L . Note that $>_{\text{LSDC}}$ is irreflexive and transitive : it is a strict partial ordering.

When $\mathcal{S}_u = \mathcal{S}_v$, $\mathcal{D}(u, v)$ is the empty set. Moreover, when the two competing decisions are incomparable using $>_{\text{LSDC}}$, $\text{Min}_{C_i \in \mathcal{D}(u, v)} u_i = \text{Min}_{C_i \in \mathcal{D}(u, v)} v_i$. Indeed, let γ be the next element greater than this value in L . It is then obvious that while for all $\beta < \gamma$, $(\mathcal{S}_u)_\beta = (\mathcal{S}_v)_\beta$, we cannot have $(\mathcal{S}_u)_\gamma \subset (\mathcal{S}_v)_\gamma$ nor $(\mathcal{S}_u)_\gamma \supset (\mathcal{S}_v)_\gamma$. This is because $\text{Min}_{C_i \in \mathcal{D}(u, v)} u_i = u_k = \text{Min}_{C_i \in \mathcal{D}(u, v)} v_i = v_l$ with $k \neq l$. In summary :

$$\vec{u} \approx_{\text{LSDC}} \vec{v} \Leftrightarrow \text{Min}_{C_i \in \mathcal{D}(u, v)} u_i = \text{Min}_{C_i \in \mathcal{D}(u, v)} v_i$$

It is worth noticing that this formulation of $>_{\text{LSDC}}$ implies that this SWO cannot be represented by a CUF. Indeed, suppose there is a function f such that $\vec{u} >_{\text{LSDC}} \vec{v} \Leftrightarrow f(\vec{u}) > f(\vec{v})$. Then clearly the relation $\vec{u} R \vec{v} \Leftrightarrow f(\vec{u}) = f(\vec{v})$ is an equivalence relation expressing that neither $\vec{u} >_{\text{LSDC}} \vec{v}$ nor $\vec{v} >_{\text{LSDC}} \vec{u}$. But the relation $\text{Min}_{C_i \in \mathcal{D}(u, v)} u_i = \text{Min}_{C_i \in \mathcal{D}(u, v)} v_i$ is not an equivalence relation (it is not transitive) contrary to R . However the formulation indicates that there exists a 2-argument function $M(\vec{u}, \vec{v})$ such that $\vec{u} >_{\text{LSDC}} \vec{v} \Leftrightarrow M(\vec{u}, \vec{v}) > M(\vec{v}, \vec{u})$.

The relation $>_{\text{LSDC}}$ is a refinement of $>_{\text{min}}$. Indeed, it is obvious to see that

$$\vec{u} >_{\text{Min}} \vec{v} \Rightarrow \vec{u} >_{\text{LSDC}} \vec{v}$$

The converse implication is not verified. We only have :

$$\vec{u} \succ_{\text{LSDC}} \vec{v} \quad \Rightarrow \quad \vec{u} \succ_{\text{Min}} \vec{v}$$

In other terms, this new preference relation is more selective than the egalitarian one : it introduces some preferences over the decisions which are considered equivalent by \succ_{Min} . If the constraints are all-or-nothing (i.e., allowing satisfaction degrees in $\{0,1\}$), \succ_{LSDC} prefers s_u to s_v if and only if all the C_i satisfied by s_v are also satisfied by s_u and there are some C_i satisfied by s_u which are violated by s_v . In other terms, \succ_{LSDC} is equivalent to \succ_{Pareto} in the non-fuzzy case.

If several satisfaction degrees are allowed, it is a refinement of the Pareto-ordering. Indeed it is easy to see that: $\vec{u} \succ_{\text{Pareto}} \vec{v} \quad \Rightarrow \quad \vec{u} \succ_{\text{LSDC}} \vec{v}$

The converse implication is not verified. We only have :

$$\vec{u} \succ_{\text{LSDC}} \vec{v} \quad \Rightarrow \quad \vec{u} \succ_{\text{Pareto}} \vec{v}$$

It means that the LSDC-optimal decisions are both maximin and Pareto-optimal: LSDC refines the Min-ordering and the Pareto-ordering. Nevertheless, all decisions being both maximin and Pareto-optimal are not LSDC-optimal. Consider for instance that $S = \{s_u, s_v\}$, $\vec{u} = (0.4 \ 0.9 \ 0.1 \ 0.3)$, $\vec{v} = (0.9 \ 0.4 \ 0.1 \ 0.2)$; s_u and s_v are maximin and Pareto-optimal, but s_v is NOT LSDC-optimal: $\vec{u} \succ_{\text{LSDC}} \vec{v}$. Going back to Example 2, decisions (3, 2), (3, 3), (4, 2) and (4, 3) are maximin, Pareto-optimal and LSDC-optimal.

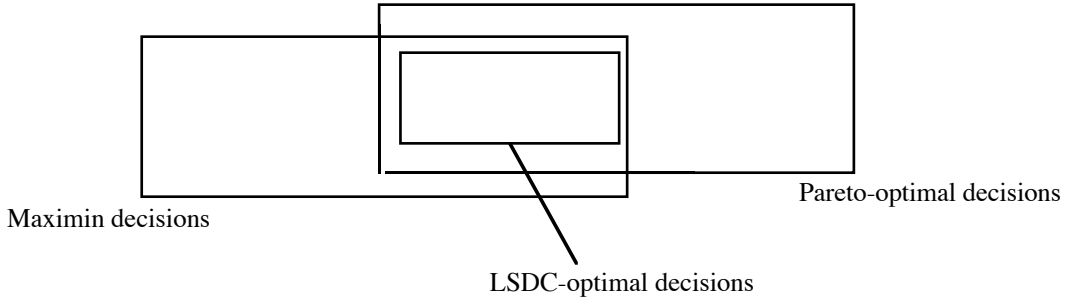

Figure 5

3.2 Other formulations of the LSDC-ordering

3.2.1. Comparing level-cuts.

The ordering \succ_{LSDC} can also be described from an inclusion-based point of view, that is as a refinement of the Pareto-ordering (Fargier et al.[18]). Let $(\mathcal{S}_w)_\gamma$ denote the γ -cut of \mathcal{S}_w , the fuzzy set of constraints satisfied by decision s_w : $(\mathcal{S}_w)_\gamma = \{C_i \in \mathcal{C} / \mu_{C_i}(s_w) \geq \gamma\}$. This approach consists in comparing the level-cuts of fuzzy sets of satisfied constraints, \mathcal{S}_u and \mathcal{S}_v , from the lower levels to the greatest ones, until reaching a level α such $(\mathcal{S}_u)_\alpha \neq (\mathcal{S}_v)_\alpha$. At this level, if $(\mathcal{S}_u)_\alpha \supset (\mathcal{S}_v)_\alpha$, s_u is preferred to s_v ; if $(\mathcal{S}_u)_\alpha \subset (\mathcal{S}_v)_\alpha$, s_v is preferred to s_u . Otherwise, the decisions are incomparable and will be considered as indifferent. When the satisfaction scale L is finite, the following result holds:

Proposition 1: $\vec{u} \succ_{\text{LSDC}} \vec{v}$ if and only if $\exists \alpha \in L$ such that

- (i) $\forall \beta \in L$ such that $\beta < \alpha$, $(\mathcal{S}_u)_\beta = (\mathcal{S}_v)_\beta$
- (ii) $(\mathcal{S}_u)_\alpha \supset (\mathcal{S}_v)_\alpha$.

Proof (L finite):

Let γ be such that $\forall \beta < \gamma$, $\{C_i / u_i \geq \beta\} = \{C_i / v_i \geq \beta\}$ and $\{C_i / u_i \geq \gamma\} \supset \{C_i / v_i \geq \gamma\}$. Then if $u_i < \gamma$ and $v_i < \gamma$, it implies that $u_i = v_i$; indeed, if $u_i < v_i$, then putting $\beta = v_i$, obviously, $\{C_k / u_k \geq \beta\} \neq \{C_k / v_k \geq \beta\}$ (contradiction); and similarly if $u_i > v_i$. Now let C_k be such that $v_k < \gamma$ and $u_k \geq \gamma$. C_k exists due to the second condition (ii). Clearly, $C_k \in \mathcal{D}(u, v)$, while $\forall i$, $u_i < \gamma$ and $v_i < \gamma$ implies $C_i \notin \mathcal{D}(u, v)$. Hence $\text{Min}_{C_i \in \mathcal{D}(u, v)} u_i > \text{Min}_{C_i \in \mathcal{D}(u, v)} v_i$.

Suppose $\text{Min}_{C_i \in \mathcal{D}(u, v)} u_i > \text{Min}_{C_i \in \mathcal{D}(u, v)} v_i$ and let $v_k = \text{Min}_{C_i \in \mathcal{D}(u, v)} v_i$. Choose γ the next element greater than v_k in the scale L . With this choice of γ , $\forall \beta < \gamma$, $\{C_i / u_i \geq \beta\} = \{C_i / v_i \geq \beta\}$ and $\{C_i / u_i \geq \gamma\} \supset \{C_i / v_i \geq \gamma\}$, obviously.

As soon as the set of decisions S is finite, L is also finite. Otherwise, it remains possible to compare the level-cuts, using the following definition :

- $\vec{u} >_{\text{LSDC}} \vec{v}$ if and only if $\exists \alpha \in L$ such that (i) $\forall \beta \in L$ such that $\beta \leq \alpha$, $(\mathcal{S}_u)_\beta = (\mathcal{S}_v)_\beta$
(ii) $\exists \gamma > \alpha \forall \beta \in (\alpha, \gamma]$, $(\mathcal{S}_u)_\beta \supset (\mathcal{S}_v)_\beta$

3.2.2 Comparing level-sections.

In fact, comparing the level-cuts is equivalent to compare, for each level in L , the set of constraints which are satisfied to this degree *exactly*, that is, level-sections.

Proposition 2: $\vec{u} >_{\text{LSDC}} \vec{v} \Leftrightarrow \exists \gamma \in L$ such that

- (i) $\forall \beta \in L$ such that $\beta < \gamma$, $\{C_i / u_i = \beta\} = \{C_i / v_i = \beta\}$
- (ii) $\{C_i / u_i = \gamma\} \subset \{C_i / v_i = \gamma\}$

Proof (L finite):

$\exists \gamma \in L$ such that (i) $\forall \beta \in L$ such that $\beta < \gamma$, $\{C_i / u_i = \beta\} = \{C_i / v_i = \beta\}$
(ii) $\{C_i / u_i = \gamma\} \subset \{C_i / v_i = \gamma\}$

$\Leftrightarrow \exists \gamma \in L$ such that (i) $\forall \beta \in L$ such that $\beta < \gamma$, $\{C_i / u_i \leq \beta\} = \{C_i / v_i \leq \beta\}$
(ii) $\{C_i / u_i \leq \gamma\} \subset \{C_i / v_i \leq \gamma\}$

\Leftrightarrow (by complementation) $\exists \gamma \in L$ such that (i) $\forall \beta \in L$ such that $\beta < \gamma$, $\{C_i / u_i > \beta\} = \{C_i / v_i > \beta\}$
(ii) $\{C_i / u_i > \gamma\} \supset \{C_i / v_i > \gamma\}$

Choosing α as the lowest level in L greater to γ , the last condition formulates as follows :

- $\exists \alpha \in L$ such that (i) $\forall \beta \in L$ such that $\beta < \alpha$ $\{C_i / u_i \geq \beta\} = \{C_i / v_i \geq \beta\}$
(ii) $\{C_i / u_i \geq \alpha\} \supset \{C_i / v_i \geq \alpha\}$

Note that, in condition (ii) of Proposition 2, the inclusion direction is not the same as when using level-cuts as in the former definition. Indeed, $\vec{u} >_{\text{LSDC}} \vec{v}$ as soon as there is a level α such that the set of satisfied constraints are not the same. The decision corresponding to the best vector is the one satisfying the smaller set of C_i to

the degree α , since the constraints not satisfied to degree α and not considered previously by (i) are satisfied to a higher degree.

3.2.3 Using increasingly arranged utility vectors

Finally, let us establish a third definition of $>_{\text{LSDC}}$ [18] that we will need in the next section. Consider the *increasingly arranged* utility vector corresponding to \vec{u} : it is a vector $\vec{u}^* = (u_{i_1}, u_{i_2}, \dots, u_{i_n})$ such that $u_{i_1} \leq u_{i_2} \leq \dots \leq u_{i_n}$ (u_{i_k} is the satisfaction degree of C_{i_k}). When several constraints are satisfied to the same degree by \vec{u} , the corresponding utilities are ranked in increasing index values: u_{i_k} comes before $u_{i_{k'}}$ in \vec{u}^* if and only if $u_{i_k} < u_{i_{k'}}$, or $u_{i_k} = u_{i_{k'}}$ and $i_k < i_{k'}$.

The comparison of two potential decisions using $>_{\text{LSDC}}$ corresponds to a pointwise comparison of $\vec{u}^* = (u_{i_1}, u_{i_2}, \dots, u_{i_n})$ and $\vec{v}^* = (v_{j_1}, v_{j_2}, \dots, v_{j_n})$: we have to find the lower index k such that $u_{i_k} \neq v_{j_k}$ or $i_k \neq j_k$. If $u_{i_k} > v_{j_k}$, then $\vec{u} >_{\text{LSDC}} \vec{v}$; if $u_{i_k} < v_{j_k}$, then $v >_{\text{LSDC}} u$; otherwise, u and v are indifferent (since incomparable). Formally :

Proposition 3 : $\vec{u} >_{\text{LSDC}} \vec{v} \Leftrightarrow \exists m \in \{1, \dots, n\}$ such that (i) $\forall \lambda < m, i_\lambda = j_\lambda$ and $u_{i_\lambda} = v_{j_\lambda}$
(ii) $u_{i_m} > v_{j_m}$

Proof: $\vec{u} >_{\text{LSDC}} \vec{v} \Leftrightarrow \text{Min}_{C_i \in \mathcal{D}(u, v)} u_i > \text{Min}_{C_i \in \mathcal{D}(u, v)} v_i$. Hence $u_{i_k} > v_{j_m}$ for some k and m . Now $\forall \lambda < m, C_{j_\lambda} \notin \mathcal{D}(u, v)$, and constraint C_{j_λ} does not discriminate. Hence if $i = j_\lambda$ then $u_i = v_i$. Hence $\forall \lambda < m, i_\lambda = j_\lambda$. Now since $C_{j_m} \in \mathcal{D}(u, v)$, $u_{i_m} \geq u_{i_k} > v_{j_m}$. The converse is obvious.

3.3 Relationships to preferred sub-bases in logic

The LSDC preference relation is well known in syntactical non-monotonic reasoning. It has been proposed by Brewka [4] and studied by Geffner [23], Nebel [30], Cayrol, Royer and Saurel [5], Dubois, Lang and Prade [12], Benferhat et al. [3]. Let us recall some definitions concerning layered knowledge bases. A layered knowledge base K is a set of weighted propositional formulas (ϕ_i, p_i) where $p_i > p_j$ indicates that ϕ_i has priority over ϕ_j . Following Lang [25] each formula ϕ_i is understood as a constraint, each weight p_i as a priority, and each logical interpretation as a solution s_u to a constrained problem. The utility vector \vec{u} attached to solution s_u is of the form (u_1, \dots, u_n) where $u_i = 1$ if s_u satisfies ϕ_i and $u_i = 1 - p_i$ otherwise (as pointed out in section 2.1). By definition, we assume $p_1 \geq \dots \geq p_n$.

A *strongly maximal consistent subset* of K is defined as follows : let K_1 be the subset of K containing the formulas of higher priority. Let \mathcal{K}_1 be a maximal consistent subset of K_1 . Then let K_2 be the subset of K containing the formulas of second priority. Then \mathcal{K}_2 is the maximal consistent subset of formulas formed by adding to \mathcal{K}_1 as many formulas from K_2 as possible. Continue down to the lowest priority level. The consistent subset of K so obtained is a strongly maximal consistent subset (SMCS) of K . This notion is also called "preferred sub-base" by Brewka [4].

Proposition 4 : Any solution to a strongly maximal consistent subset of constraints is LSDC-optimal and conversely.

Proof.

If K is consistent, then, for best solutions, $u_i = 1, \forall i$, and the proposition trivially holds. Otherwise, let s_u be a solution to a SMCS of K . Assume it is not a LSDC-optimal, i.e., $\exists s_v$ such that $\vec{v} >_{\text{LSDC}} \vec{u}$. This means that for some $\alpha \in L$ we have : (i) $\forall \beta \in L$ such that $\beta < \alpha$ $(\mathcal{S}_u)_\beta = (\mathcal{S}_v)_\beta$ and (ii) $(\mathcal{S}_v)_\alpha \supset (\mathcal{S}_u)_\alpha$. Assume $\alpha = 1 - p_i$ (it is always possible to assume it). This means that s_u and s_v violate the same constraints of priority levels higher than p_i and that there is a constraint of priority p_i that is violated by s_u but not by s_v . Hence the subset of constraints of priority higher or equal to p_i satisfied by s_u is not maximal. It is possible to add one more constraint of priority p_i and remain consistent. Hence s_u is not solution to a SMC subset of constraints.

The converse is proved as follows : if s_u is not a solution to a SMC subset of constraints, it means that there is a level of priority p_i such that the set \mathcal{K} of constraints of priority higher than or equal to p_i is not maximal : adding another constraint of priority p_i to \mathcal{K} is possible while preserving consistency. It is then obvious that any solution to this new set of constraints is LSDC-better than s_u .

3.4 Representation of LSDC orderings by an inclusion index

As shown previously, $>_{\text{LSDC}}$ is a generalisation of the Pareto-ordering when restricted to non-fuzzy constraints : if the C_i 's take on values in $\{0,1\}$, s_u is preferred to s_v as soon as the (non-fuzzy) set of constraints satisfied by s_v is included in the (non-fuzzy) set of constraints satisfied by s_u . The Pareto ordering is also a generalisation to fuzzy constraints of this inclusion-based order, since $\vec{u} >_{\text{Pareto}} \vec{v}$ as soon as $\mathcal{S}_v \subset \mathcal{S}_u$. In the following, we argue that $>_{\text{LSDC}}$, which is technically a stratified inclusion (inclusion of level-cuts) also relates to a fuzzy set inclusion index. Indeed, we have :

Proposition 5:

$$\vec{u} >_{\text{LSDC}} \vec{v} \Leftrightarrow \text{Min}_{C_i \in \mathcal{C}} \mu_{\mathcal{S}_u}(C_i) \rightarrow \mu_{\mathcal{S}_v}(C_i) < \text{Min}_{C_i \in \mathcal{C}} \mu_{\mathcal{S}_v}(C_i) \rightarrow \mu_{\mathcal{S}_u}(C_i)$$

where \rightarrow stands for Gödel's implication, which is defined by :

$$\begin{aligned} a \rightarrow b &= 1 \text{ if } a \leq b \\ &= b \text{ otherwise.} \end{aligned}$$

Proof :

- Let us denote :

$$\Delta(u, v) = \{C_i \in \mathcal{D}(u, v) \text{ such that } u_i > v_i\}$$

$$\Delta(v, u) = \{C_i \in \mathcal{D}(u, v) \text{ such that } v_i > u_i\}$$

We have : $\mathcal{D}(u, v) = \Delta(u, v) \cup \Delta(v, u)$ (disjoint union)

- for $C_i \notin \mathcal{D}(u, v) : u_i \rightarrow v_i = v_i \rightarrow u_i = 1$; hence :

$$\text{Min}_{C_i \in \mathcal{C}} u_i \rightarrow v_i < \text{Min}_{C_i \in \mathcal{C}} v_i \rightarrow u_i \Leftrightarrow \text{Min}_{C_i \in \mathcal{D}(u, v)} u_i \rightarrow v_i < \text{Min}_{C_i \in \mathcal{D}(u, v)} v_i \rightarrow u_i$$

Note that the strict inequality forbids the case when $\mathcal{D}(u, v) = \emptyset$ since the latter enforces $v_i \rightarrow u_i = u_i \rightarrow v_i = 1$ for all i .

- for $C_i \in \mathcal{D}(u, v)$:

$$\begin{aligned} \text{if } C_i \in \Delta(v, u) & \text{ then } u_i \rightarrow v_i = 1 & \text{ and } v_i \rightarrow u_i = u_i ; \\ \text{if } C_i \in \Delta(u, v) & \text{ then } u_i \rightarrow v_i = v_i & \text{ and } v_i \rightarrow u_i = 1. \end{aligned}$$

Hence :

$$\begin{aligned} \text{Min}_{C_i \in \mathcal{D}(u, v)} u_i \rightarrow v_i &= \text{Min}_{C_i \in \Delta(u, v)} v_i & (= 1 \text{ if } \Delta(u, v) = \emptyset) \\ \text{and } \text{Min}_{C_i \in \mathcal{D}(u, v)} v_i \rightarrow u_i &= \text{Min}_{C_i \in \Delta(v, u)} u_i & (= 1 \text{ if } \Delta(v, u) = \emptyset) \end{aligned}$$

- From the two previous points, we have :

$$\text{Min}_{C_i \in \mathcal{C}} u_i \rightarrow v_i < \text{Min}_{C_i \in \mathcal{C}} v_i \rightarrow u_i \quad \Leftrightarrow \quad \text{Min}_{C_i \in \Delta(u, v)} v_i < \text{Min}_{C_i \in \Delta(v, u)} u_i \quad (1)$$

(hence $\Delta(u, v) \neq \emptyset$)

- Moreover, by definition of $\Delta(u, v)$:

$$\text{Min}_{C_i \in \Delta(u, v)} v_i < \text{Min}_{C_i \in \Delta(u, v)} u_i \quad (2)$$

$$\text{Min}_{C_i \in \Delta(v, u)} v_i > \text{Min}_{C_i \in \Delta(v, u)} u_i \quad (3)$$

- Let us denote :

$$A = \text{Min}_{C_i \in \Delta(u, v)} v_i; \quad B = \text{Min}_{C_i \in \Delta(u, v)} u_i; \quad C = \text{Min}_{C_i \in \Delta(v, u)} v_i; \quad D = \text{Min}_{C_i \in \Delta(v, u)} u_i.$$

(2) can be written as: $A < B$, (3) as $C > D$ and (1) as $A < D$

It can be shown that $(A < B \text{ and } C > D) \Rightarrow (A < D \Leftrightarrow \min(A, C) < \min(B, D))$

Hence, it holds that :

$$\begin{aligned} \text{Min}_{C_i \in \mathcal{C}} u_i \rightarrow v_i &< \text{Min}_{C_i \in \mathcal{C}} v_i \rightarrow u_i \\ &\Leftrightarrow \min(\text{Min}_{C_i \in \Delta(u, v)} v_i, \text{Min}_{C_i \in \Delta(v, u)} v_i) < \min(\text{Min}_{C_i \in \Delta(u, v)} u_i, \text{Min}_{C_i \in \Delta(v, u)} u_i) \\ &\Leftrightarrow \text{Min}_{C_i \in \mathcal{D}(u, v)} v_i < \text{Min}_{C_i \in \mathcal{D}(u, v)} u_i \\ &\Leftrightarrow \vec{u} >_{\text{LSDC}} \vec{v} \end{aligned}$$

$I(\mathcal{S}_u, \mathcal{S}_v) = \text{Min}_{C_i \in \mathcal{C}} \mu_{\mathcal{S}_u}(C_i) \rightarrow \mu_{\mathcal{S}_v}(C_i)$ is a fuzzy set inclusion degree of \mathcal{S}_u in \mathcal{S}_v (Bandler and Kohout [1]); in particular, it is equal to 1 if $\mathcal{S}_v \subseteq \mathcal{S}_u$, i. e., if $\vec{u} \geq_{\text{Pareto}} \vec{v}$.² This last formulation shows that s_u is preferred to s_v if \mathcal{S}_v is more included in \mathcal{S}_u than \mathcal{S}_u is in \mathcal{S}_v . The above result confirms that the LSDC ordering can be numerically represented by means of a two-place numerical index that plays the role of a multi-objective utility function. This Gödel-implication-based index is also proposed by De Baets [7] in order to compare solutions in multi-criteria decision making problems. However, he exploits the level cuts of the fuzzy relation induced on the solution set by the index $I(\mathcal{S}_u, \mathcal{S}_v)$, while the LSDC ordering coincides with the crisp relation obtained by comparing $I(\mathcal{S}_u, \mathcal{S}_v)$ and $I(\mathcal{S}_v, \mathcal{S}_u)$.

² $\text{Min}_{C_i \in \mathcal{C}} u_i \rightarrow v_i$ is also a generalization of the degree of guaranteed possibility (Dubois and Prade, [16]): $\Delta_\pi(A) = \inf_{i \in A} \pi(i)$ of event A , (where π is a possibility distribution over $\{1, 2, \dots, n\}$) to when A is a fuzzy set such that $\mu_A(i) = u_i$ and $\pi(i) = v_i$. In other terms, for $A = \mathcal{S}_u$ and $\pi = \mathcal{S}_v$, $\text{min}_{C_i \in \mathcal{C}} u_i \rightarrow v_i = \Delta_{\mathcal{S}_v}(\mathcal{S}_u)$. $\Delta(A)$ evaluates to what extent all the elements of A are possible. It holds that $\text{min}_{C_i \in \mathcal{C}} u_i \rightarrow v_i \geq \alpha \Leftrightarrow v_i \geq \min(\alpha, u_i)$ for all i .

4. Refining the min-ordering : the leximin ordering

Moulin [29] describes another refinement of the egalitarian ordering : the leximin ordering. This ordering is implicitly adopted by Descottes and Latombe [8] for compromising among antagonistic decision rules of various priorities. The idea is to consider the above introduced increasingly arranged vectors \vec{u}^* of satisfaction degrees by means of a lexicographic criterion. Consider for instance two utility vectors $\vec{u}_1 = (.2, .2, .3, .9)$ and $\vec{u}_2 = (.7, .2, .2, .8)$. It is easy to see that they cannot be compared by means of $>_{\text{LSDC}}$. Yet, it is clear that \vec{u}_2 can be viewed as a utility vector better than \vec{u}_1 , since with \vec{u}_2 two constraints are reasonably satisfied (at least .7) while with \vec{u}_1 only one is such. This ordering can be found by comparing the increasingly arranged vectors \vec{u}_1^* and \vec{u}_2^* componentwise in a lexicographic way, from the lowest rank to the highest ones. It can be checked that \vec{u}_2^* dominates \vec{u}_1^* on the third component. This section makes this comparison procedure more precise.

4.1 Properties of the leximin ordering

Let \vec{u} and \vec{v} be two vectors whose components are such that $u_1 \leq u_2 \leq \dots \leq u_n$ and $v_1 \leq v_2 \leq \dots \leq v_n$. Define a lexicographic ranking of such vectors as follows:

$$\vec{u} >_{\text{Lex}} \vec{v} \text{ if and only if } \exists k \leq n \text{ such that } \forall i < k, u_i = v_i \text{ and } u_k > v_k$$

The two vectors are equally ranked only if they are the same. More generally, the leximin SWO \succ_{Lex} over U is extended to any vectors \vec{u} and \vec{v} as follows:

$$\begin{aligned} \vec{u} >_{\text{Lex}} \vec{v} &\Leftrightarrow \vec{u}^* >_{\text{Lex}} \vec{v}^* \\ \vec{u} \approx_{\text{Lex}} \vec{v} &\Leftrightarrow \vec{u}^* = \vec{v}^* \Leftrightarrow \forall i, u_i^* = v_i^* = v_{j_i} \end{aligned}$$

where \vec{u}^* and \vec{v}^* are the increasingly arranged vectors $(u_{i_1}, u_{i_2}, \dots, u_{i_n})$ and $(v_{j_1}, v_{j_2}, \dots, v_{j_n})$ induced by \vec{u} and \vec{v} as in Section 3.2.3. Clearly $>_{\text{Lex}}$ is a strict partial order, \succ_{Lex} a complete preorder on U (hence \approx_{Lex} is transitive). A decision s_u is said to be Leximin-optimal if there is no better decision according to $>_{\text{Lex}}$:

$$\vec{u} \text{ is Leximin-optimal} \Leftrightarrow \text{there is no } \vec{v} \in U \text{ such that } \vec{v} >_{\text{Lex}} \vec{u}$$

Going back to Example 2, the decisions s_3 and s_2 which are also maximin, Pareto-optimal and LSDC-optimal, are the only leximin-optimal decisions. In particular, these solutions are preferred to s_5 and s_6 , which are not leximin-optimal although they are maximin, Pareto-optimal and LSDC-optimal.

As shown by Moulin [29], the leximin-ordering is a refinement of both the Pareto-ordering and the Min-ordering :

$$\bullet \vec{u} >_{\text{Min}} \vec{v} \quad \Rightarrow \quad \vec{u} >_{\text{Lex}} \vec{v} \quad \bullet \vec{u} >_{\text{Pareto}} \vec{v} \quad \Rightarrow \quad \vec{u} >_{\text{Lex}} \vec{v}$$

But it is NOT a refinement of the utilitarian Σ -ordering: a solution \vec{u} whose least satisfied constraint is less satisfied than the least satisfied constraint of another one \vec{v} will not be leximin-preferred, regardless of the sum of the other partial satisfaction

degrees. The leximin ordering is still egalitarian. Finally, Moulin [29] has shown that this ordering is a SWO which cannot be represented by a CUF, despite the fact that it is a complete preordering.

In the remainder of this section, after comparing the leximin ordering with the LSDC-ordering, we propose a representation theorem with a 2-place numerical function.

4.2 Leximin ordering versus LSDC-ordering

A first way to relate $>_{\text{LSDC}}$ and $>_{\text{Lex}}$ is to consider the definition of $>_{\text{LSDC}}$ as the comparison of two potential decisions based on a pointwise comparison of the increasingly arranged vectors $\vec{u}^* = (u_{i_1}, u_{i_2}, \dots, u_{i_n})$ and $\vec{v}^* = (v_{j_1}, v_{j_2}, \dots, v_{j_n})$. Recall from Section 3.2.3 that:

$$\vec{u} >_{\text{LSDC}} \vec{v} \Leftrightarrow \exists k \in \{1, \dots, n\} \text{ such that } \begin{array}{l} \text{(i) } \forall \lambda < k, i_\lambda = j_\lambda \text{ and } u_{i_\lambda} = v_{j_\lambda} \\ \text{(ii) } u_{i_k} > v_{j_k} \end{array}$$

Using the leximin comparison, we only drop the component equality condition in (i) since the leximin ordering can be expressed as :

$$\vec{u} >_{\text{Lex}} \vec{v} \Leftrightarrow \exists k \in \{1, \dots, n\} \text{ such that } \begin{array}{l} \text{(i) } \forall \lambda < k, u_{i_\lambda} = v_{j_\lambda} \\ \text{(ii) } u_{i_k} > v_{j_k} \end{array}$$

It obviously follows that $>_{\text{Lex}}$ is a refinement of $>_{\text{LSDC}}$:

$$\vec{u} >_{\text{Min}} \vec{v} \Rightarrow \vec{u} >_{\text{LSDC}} \vec{v} \Rightarrow \vec{u} >_{\text{Lex}} \vec{v}$$

Leximin optimal decisions are always LSDC-optimal decisions, and thus maximin and Pareto-optimal : $>_{\text{Lex}}$ is the most selective among these preference relations. Reciprocal implications are not verified ; we only have :

$$\vec{u} >_{\text{Lex}} \vec{v} \Rightarrow \vec{u} \succcurlyeq_{\text{LSDC}} \vec{v}; \quad \vec{u} >_{\text{Lex}} \vec{v} \Rightarrow \vec{u} \succcurlyeq_{\text{Min}} \vec{v}$$

The leximin ordering discriminates among equivalent optimal decisions according to the Min-ordering ($\min u_i = \min v_i$) and among incomparable ones with respect to $>_{\text{Pareto}}$ and $>_{\text{LSDC}}$. It remains true that two potential decisions satisfying exactly the same set of constraints will be indifferent according to any of these SWO.

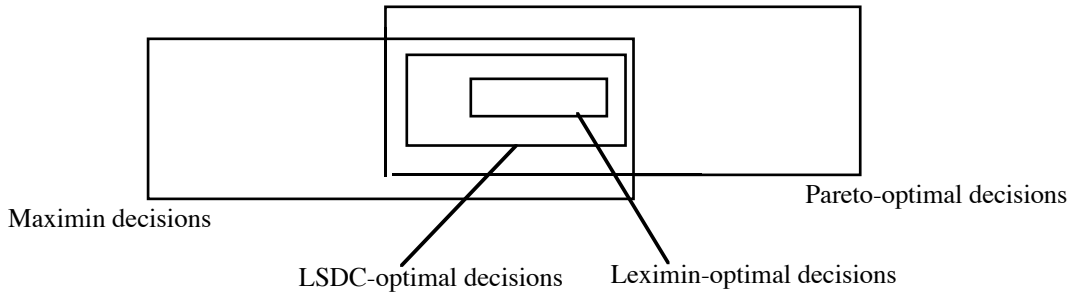

Figure 6

4.3 Relation to lexicographically preferred sub-bases

The leximin ordering has been introduced in the setting of possibilistic logic as a tool for selecting maximal consistent subsets of formulas in certainty-layered logical databases (Dubois, Lang and Prade, [12]). Referring to notations of Section 3.3, a lexicographically maximal consistent subset of a possibilistic knowledge-base K is obtained as follows: rank the consistent subsets S of K by considering the weights p_i bearing on formulas ϕ_i not in S . If S is to serve as a consistent substitute of K , the more formulas it contains, the better. The higher the weights of formulas in S the better, since p_i is handled as a degree of priority of the constraint modelled by the formula ϕ_i . Assume K has n formulas in it, S is a consistent subset of K and let p_S be the vector of weights such that $p_{S_i} = p_i$ if $\phi_i \notin S$, and 0 otherwise. Vector p_S accounts for formulas not in S . Let p_S^- be the same vector with components $p_{S_{i\lambda}}$ ranked in *decreasing* order. Then $S \succ_{\text{Lex}} T$ if and only if $\exists k$, positive integer, such that

$$(i) \forall \lambda < k, p_{S_{i\lambda}} = p_{T_{j\lambda}}$$

$$(ii) p_{S_{ik}} < p_{T_{jk}}$$

S is lexicographically equivalent (\approx_{Lex}) to T if $p_S^- = p_T^-$. A lexicographically maximal consistent subset (LMCS) of K is a maximal element of the so-built complete partial ordering \succ_{Lex} . Let s be an interpretation (in the logical sense) of K , viewed as a Boolean vector such that $s_i = 1$ if ϕ_i is true for s and 0 otherwise. The subset of formulas true for s is denoted $S(s)$. Let u_s be the vector of satisfaction degrees attached to s , and whose components are defined by $u_i = 1 - p_i$ if $s_i = 0$ and 1 otherwise. In possibilistic logic (Dubois et al., 1994) the degree of membership of interpretation s to the fuzzy set of models of K is $\min_{i=1,n} u_i$. It is clear that if s and t are two interpretations of K , $S(s) \succ_{\text{Lex}} S(t)$ if and only if $u_s \succ_{\text{Lex}} u_t$ in the sense of the leximin ordering defined in the previous section; just notice that the components in vectors $p_{S(s)}$ and u_s are such that $u_i \leq u_j$ if and only if $p_{S(s)_i} \geq p_{S(s)_j}$. More details on the links between maximal consistent subbases and the various orderings studied in this paper appear in [3].

4.4 Leximin ordering and cardinality of level-cuts

When the satisfaction scale L is finite, we can propose another formulation of the Leximin-ordering. Let $|A|$ be the cardinality of A .

Proposition 6 : $\vec{u} \succ_{\text{Lex}} \vec{v}$ is equivalent to any of the following statements:

- 1) $\exists \alpha \neq 0 \in L$ such that
 - (i) $\forall \beta \in L$ such that $\beta < \alpha$, $|\{C_i / u_i = \beta\}| = |\{C_i / v_i = \beta\}|$
 - (ii) $|\{C_i / u_i = \alpha\}| < |\{C_i / v_i = \alpha\}|$
- 2) $\exists \alpha \neq 0 \in L$ such that
 - (i) $\forall \beta \in L$ such that $\beta < \alpha$, $|\{C_i / u_i \leq \beta\}| = |\{C_i / v_i \leq \beta\}|$
 - (ii) $|\{C_i / u_i \leq \alpha\}| < |\{C_i / v_i \leq \alpha\}|$
- 3) $\exists \alpha \neq 0 \in L$ such that
 - (i) $\forall \beta \in L$ such that $\beta < \alpha$, $|\{C_i / u_i > \beta\}| = |\{C_i / v_i > \beta\}|$
 - (ii) $|\{C_i / u_i > \alpha\}| > |\{C_i / v_i > \alpha\}|$

- 4) $\exists \alpha \neq 0 \in L$ such that (i) $\forall \beta \in L$ such that $\beta < \alpha$, $|\{C_i / u_i \geq \beta\}| = |\{C_i / v_i \geq \beta\}|$
(ii) $|\{C_i / u_i \geq \alpha\}| > |\{C_i / v_i \geq \alpha\}|$
- 5) $\exists \alpha \neq 0 \in L$ such that (i) $\forall \beta \in L$ such that $\beta < \alpha$, $|\{C_i / u_i < \beta\}| = |\{C_i / v_i < \beta\}|$
(ii) $|\{C_i / u_i < \alpha\}| > |\{C_i / v_i < \alpha\}|$.

Proof:

The first equivalence is obvious. The second statement follows obviously from the first by simple addition, and the third from the second, getting strong level-cuts by complementation. The fourth statement obtains by putting together the first and the third statement. The fifth one is obtained by complementation.

In other terms, the leximin comparison is based on a notion of cardinality of level-cuts of fuzzy sets: the successive level-cuts of \mathcal{S}_u and \mathcal{S}_v are compared bottom up, as with the LSDC-ordering, until reaching a level α where the *cardinalities* of $(\mathcal{S}_u)_\alpha$ and $(\mathcal{S}_v)_\alpha$ are different. The decision corresponding to the greatest of the two cardinalities is considered as better than the other.

When constraints are non-fuzzy (i.e., either satisfied or not satisfied), $\vec{u} >_{Lex} \vec{v}$ if and only if the number of constraints satisfied by s_u is greater than the number of those which are satisfied by s_v , or, equivalently, if the number constraints violated by s_u is lower than the number of those which are violated by s_v . It then collapses with the utilitarian SWO.

Indeed, if L involves only two levels (e.g., $L = \{0,1\}$), the second formulation of $>_{Lex}$ becomes :

$$\begin{aligned} \vec{u} >_{Lex} \vec{v} &\Leftrightarrow |\mathcal{S}_u| > |\mathcal{S}_v| && \Leftrightarrow |\mathcal{S}_u^c| < |\mathcal{S}_v^c| \\ \vec{u} \approx_{Lex} \vec{v} &\Leftrightarrow |\mathcal{S}_u| = |\mathcal{S}_v| && \Leftrightarrow |\mathcal{S}_u^c| = |\mathcal{S}_v^c| \end{aligned}$$

where \mathcal{S}_u^c is the complement of the set of constraints satisfied by s_u , i.e., the set of constraints violated by s_u . Decision s_u is preferred to decision s_v if it satisfies more constraints - which is equivalent to say that s_u is preferred to s_v if it violates less constraints. In a sense, the leximin ordering combines the utilitarian and egalitarian approaches, being egalitarian when considering different satisfaction levels, but utilitarian at a fixed satisfaction level.

4.5 Leximin ordering and fuzzy cardinality

Using fuzzy sets theory, a utilitarian aspect of leximin approach can be made clearer : as we shall show, its aim is to minimise the number of *violated* fuzzy constraints, in the sense of a fuzzy-valued cardinality.

First, notice that since u_i estimates to what extent u satisfies C_i , $1 - u_i$ estimates to what extent it violates this constraint. The set of constraints violated by s_u is nothing but the complement of \mathcal{S}_u , the fuzzy set of constraints it satisfies :

$$\begin{aligned} \mu_{\mathcal{S}_u^c}: \quad \mathcal{C} &\rightarrow L = [0,1] \\ C_i &\mapsto \mu_{\mathcal{S}_u^c}(C_i) = 1 - \mu_{\mathcal{S}_u}(C_i) = 1 - u_i . \end{aligned}$$

The question is now to determine the fuzzy number of constraints partially violated by a solution s_u , i.e., to determine the fuzzy cardinality of \mathcal{S}_u^c . Suppose that a constraint C_i is considered as satisfied as soon as $u_i \geq \alpha$; then any C_j such that $u_j \geq \alpha$ should be considered as satisfied as well. Conversely, if one considers that C_i is violated when its violation degree is at least $1 - u_i \geq \alpha$, one must accept that any C_j such that $1 - u_j \geq \alpha$ is also violated by the decision. The main idea here is that the same level of violation (resp. satisfaction) should be used to describe the violation (resp. satisfaction) of all the constraints at the same time.

The number of constraints which are violated by a decision, in other terms the cardinality of \mathcal{S}_u^c is thus a fuzzy number $nv(u)$ defined by Zadeh [36] (see also Dubois and Prade [14]) :

$$\mu_{nv(u)}(x) = \max \{ \alpha / |(\mathcal{S}_u^c)_\alpha| = x \}$$

Note that $|(\mathcal{S}_u^c)_\alpha|$ evaluates the number of constraints that are violated at least at level α , i.e., satisfied at most at level $1-\alpha$. Consequently, the number of constraints violated by a decision is not independent from the number of constraints violated by another one. Let us take an example, outside decision-making. Suppose a set of six coloured objects : O1 (deep blue), O2 (turquoise), O3 (turquoise), O4 (apple green), O5 (deep blue), O6 (turquoise), O7 (apple green) and O8 (sea green). The colour "blue" is a gradual concept, which can be described by means of a fuzzy subset of the set of existing colours (see Figure 7).

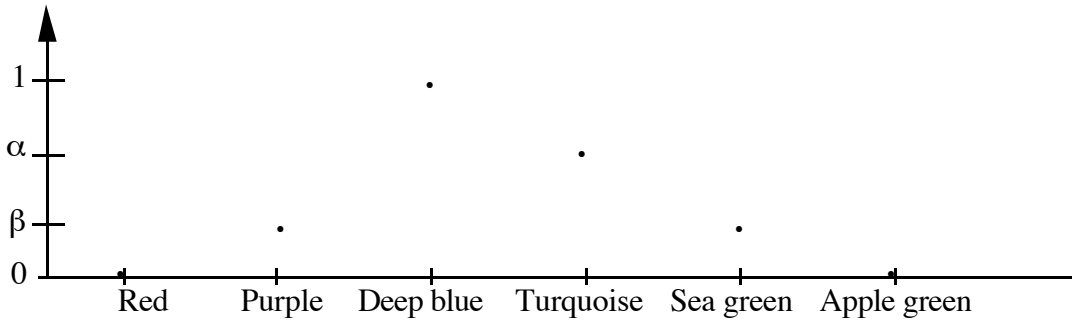

Figure 7 : The colour blue as a fuzzy concept.

Suppose Paul owns objects O1, O2, O3, O4 and John objects O5, O6, O7, O8. If turquoise is not considered as a blue, both guys own exactly one blue object. If turquoise is accepted among the blue colours (degree α), Paul owns 3 blue objects and John 2. If sea-green is also a blue colour (degree β), both have 3 blue objects, since turquoise is more a blue colour than sea green. But one could never say that Paul has 3 blue objects and John only one (why assuming turquoise is blue for Paul and not for

John ?). Similarly the fuzzy values $nv(u)$ and $nv(v)$ of constraints violated by u and v are restricted by a joint relation :

$$\mu_{nv(u), nv(v)}(x, y) = \max \{ \alpha / |(\mathcal{S}_u^c)_\alpha| = x \text{ and } |(\mathcal{S}_v^c)_\alpha| = y \}$$

This relation is not decomposable in the sense that

$$\mu_{nv(u), nv(v)}(x, y) < \min(\mu_{nv(u)}(x), \mu_{nv(v)}(y)), \text{ generally.}$$

When the numbers of violated constraints are fuzzy numbers, determining whether u or v violates the least number of constraints C_i is a problem of fuzzy number comparison. Possibility theory (Zadeh [35]) provides a tool for comparing two fuzzy numbers X and Y whose values are restricted by a joint relation R , by means of possibility and necessity measures :

$$\Pi(X = Y) = \sup_x \mu_R(x, x)$$

$$N(X = Y) = 1 - \sup_{(x, y) \text{ such that } x \neq y} \mu_R(x, y)$$

$$\Pi(X < Y) = \sup_{(x, y) \text{ such that } x < y} \mu_R(x, y)$$

$$N(X \leq Y) = 1 - \sup_{(x, y) \text{ such that } x > y} \mu_R(x, y)$$

We shall consider that $X < Y$ if $\Pi(X < Y) > \Pi(Y < X)$, or equivalently $N(X \leq Y) > N(Y \leq X)$. Hence we can compute

$$\begin{aligned} \Pi(nv(u) < nv(v)) &= \sup_{(x, y) \text{ such that } x < y} \mu_{nv(u), nv(v)}(x, y) \\ &= \sup_{(x, y) \text{ such that } x < y} \max \{ \alpha / |(\mathcal{S}_u^c)_\alpha| = x \text{ and } |(\mathcal{S}_v^c)_\alpha| = y \} \\ &= \max \{ \alpha / |(\mathcal{S}_u^c)_\alpha| < |(\mathcal{S}_v^c)_\alpha| \} \end{aligned}$$

It can be proved that (see appendix) :

$$\forall \vec{u}, \vec{v} \quad nv(u) \neq nv(v) \text{ if and only if } \Pi(nv(u) < nv(v)) \neq \Pi(nv(v) < nv(u))$$

That is to say that the possibility measure is discriminating enough to determine the least of two fuzzy cardinalities. In particular, $nv(u) = nv(v)$ is equivalent to $\Pi(nv(u) < nv(v)) = \Pi(nv(v) < nv(u)) = 0$. Hence we can claim that s_u violates less fuzzy constraints than s_v if and only if $\Pi(nv(u) < nv(v)) > \Pi(nv(v) > nv(u))$.

We can now prove that preferring the decision violating the least fuzzy constraints is equivalent to ordering them with the leximin SWO. Namely, *viewing the leximin ordering in the context of fuzzy sets theory, we can interpret it in terms of fuzzy cardinality*. Formally :

Proposition 7: $\vec{u} >_{\text{lex}} \vec{v} \Leftrightarrow \Pi(nv(u) < nv(v)) > \Pi(nv(v) < nv(u))$

Proof (finite L): suppose $\Pi(nv(u) < nv(v)) > \Pi(nv(v) < nv(u))$.

Let $\alpha^* = \Pi(nv(u) < nv(v)) = \max \{ \alpha / |(\mathcal{S}_u^c)_\alpha| < |(\mathcal{S}_v^c)_\alpha| \}$.

$\Pi(nv(u) < nv(v)) > \Pi(nv(v) < nv(u))$ is equivalent to the three conditions:

(i) $|(\mathcal{S}_u^c)_{\alpha^*}| < |(\mathcal{S}_v^c)_{\alpha^*}|$

(ii) $\forall \beta > \alpha^*, |(\mathcal{S}_u^c)_\beta| \geq |(\mathcal{S}_v^c)_\beta|$

(iii) $\alpha^* > \Pi(nv(v) < nv(u))$, i.e., $\forall \beta > \alpha^*, |(\mathcal{S}_u^c)_\beta| \leq |(\mathcal{S}_v^c)_\beta|$

(ii) and (iii) summarize in : $\forall \beta > \alpha^*, |\mathcal{S}_u^c)_\beta| = |\mathcal{S}_v^c)_\beta|$. Hence :

$$\Pi(nv(u) < nv(v)) > \Pi(nv(v) < nv(u))$$

$$\Leftrightarrow \exists \alpha^* \in [0, 1] \text{ such that} \quad \begin{aligned} \text{(i)} & \quad |\mathcal{S}_u^c)_{\alpha^*}| < |\mathcal{S}_v^c)_{\alpha^*}| \\ \text{(ii)} & \quad \forall \beta > \alpha^*, |\mathcal{S}_u^c)_\beta| = |\mathcal{S}_v^c)_\beta| \end{aligned}$$

For any fuzzy set A, it holds that : $(A^c)_\gamma = \{x / \mu_A(x) \leq 1 - \gamma\}$. So :

$$\Pi(nv(u) < nv(v)) > \Pi(nv(v) < nv(u))$$

$$\Leftrightarrow \exists \alpha^* \in [0, 1] \text{ such that}$$

$$\text{(i)} \quad \forall \beta > \alpha^*, |\{x / \mu_{\mathcal{S}_u}(x) \leq 1 - \beta\}| = |\{x / \mu_{\mathcal{S}_v}(x) \leq 1 - \beta\}|$$

$$\text{(ii)} \quad |\{x / \mu_{\mathcal{S}_u}(x) \leq 1 - \alpha^*\}| < |\{x / \mu_{\mathcal{S}_v}(x) \leq 1 - \alpha^*\}|$$

With $\gamma^* = 1 - \alpha^*$ and $\delta = 1 - \beta$: $\Pi(nv(u) < nv(v)) > \Pi(nv(u) < nv(v))$

$$\Leftrightarrow \exists \gamma^* \in [0, 1] \text{ such that}$$

$$\text{(i)} \quad \forall \delta < \gamma^*, |\{x / \mu_{\mathcal{S}_u}(x) \leq \delta\}| = |\{x / \mu_{\mathcal{S}_v}(x) \leq \delta\}|$$

$$\text{(ii)} \quad |\{x / \mu_{\mathcal{S}_u}(x) \leq \gamma^*\}| < |\{x / \mu_{\mathcal{S}_v}(x) \leq \gamma^*\}| \quad (\text{using Proposition 6})$$

$$\Leftrightarrow \exists \gamma^* \in [0, 1] \text{ such that}$$

$$\text{(i)} \quad \forall \delta < \gamma^*, |\{x / \mu_{\mathcal{S}_u}(x) \geq \delta\}| = |\{x / \mu_{\mathcal{S}_v}(x) \geq \delta\}|$$

$$\text{(ii)} \quad |\{x / \mu_{\mathcal{S}_u}(x) \geq \gamma^*\}| > |\{x / \mu_{\mathcal{S}_v}(x) \geq \gamma^*\}|$$

$$\Leftrightarrow \vec{u} >_{\text{lex}} \vec{v}$$

This result motivates two comments: first, the leximin ordering can be represented by means of a numerical function of the two vectors to be compared. Second, the leximin-optimal solutions are the ones that minimize the fuzzy number of violated constraints. In contrast the utilitarian ordering can be interpreted in terms of scalar cardinality of fuzzy sets since $\sum_i u_i$ is the scalar cardinality of \mathcal{S}_u . It is noticeable that the two main notions of fuzzy cardinality correspond to two widely known social welfare functions.

5. Refining the max ordering

The previous section has shown that the leximin SWO corresponds to the minimisation of the fuzzy number of violated constraints. When constraints are non-fuzzy, i.e., only degrees of satisfaction 0 or 1 are used, this is equivalent to maximising the number of satisfied constraints, since fuzzy and scalar cardinalities coincide in that case. Taking an anthropomorphic example, maximising the number of rich people in a population is equivalent to minimising the number of poor people, if there are only rich or poor people (those who are not rich are poor, those who are not poor are rich). But in the fuzzy case, i.e., when there are different levels of wealth (poor, middle-class, upper-middle class, rich) the two approaches are not equivalent : maximizing the number of rich people is compatible with solutions where many become poor instead of middle-class, while minimizing the number of poor (leximin order) does not account for the degree of wealth of the richer ones.

5.1 The anti-Lex (or leximax) ordering

Maximising the fuzzy number of satisfied constraints does not correspond to the leximin ordering, but to another one which is in fact a refinement of the max-ordering: we call it the "anti-lex", or "leximax" ordering. It consists in comparing the cardinalities of the level-cuts from the *higher levels down to the lower ones* :

- $\vec{u} >_{\text{anti-Lex}} \vec{v} \Leftrightarrow \exists \alpha \in L$ such that
 - (i) $\forall \beta \in L$ such that $\beta > \alpha$, $|\{C_i / u_i \geq \beta\}| = |\{C_i / v_i \geq \beta\}|$
 - (ii) $|\{C_i / u_i \geq \alpha\}| > |\{C_i / v_i \geq \alpha\}|$

Besides, the number of constraints C_i satisfied by s_u , i.e., the cardinality of \mathcal{S}_u , is defined by :

- $\mu_{\text{ns}(u)}(x) = \max \{\alpha / |\mathcal{S}_u)_\alpha| = x\}$

The cardinalities of \mathcal{S}_u and \mathcal{S}_v are restricted by a joint relation :

- $\mu_{\text{ns}(u), \text{ns}(v)}(x, y) = \max \{\alpha / |\mathcal{S}_u)_\alpha| = x \text{ and } |\mathcal{S}_v)_\alpha| = y\}$

So, we can compare \vec{u} and \vec{v} using the possibility degree $\Pi(\text{ns}(u) > \text{ns}(v))$. Preferring the decision maximising the number of satisfied constraints formulates as follows :

- s_u satisfies more constraints than $s_v \Leftrightarrow \Pi(\text{ns}(u) > \text{ns}(v)) > \Pi(\text{ns}(v) > \text{ns}(u))$.

We can show that : $u >_{\text{Anti-lex}} \vec{v} \Leftrightarrow \Pi(\text{ns}(u) > \text{ns}(v)) > \Pi(\text{ns}(v) > \text{ns}(u))$

(proof is similar to the case of the leximin ordering ; see Fargier's dissertation [19]).

This new SWO is a refinement of the max SWO and of the Pareto-ordering:

- $\vec{u} >_{\text{Max}} \vec{v} \Rightarrow \vec{u} >_{\text{Anti-lex}} \vec{v}$ • $\vec{u} >_{\text{Pareto}} \vec{v} \Rightarrow \vec{u} >_{\text{Anti-lex}} \vec{v}$

But leximin-optimality neither implies leximax optimality, nor the contrary. Referring to leximin, we compared the increasingly arranged utility vectors, discriminating the decisions by the smallest degrees that are different regardless of the highest degrees. With leximax, the vectors are compared from the higher degrees down to the lower ones, until there is a difference (hence, without reference to the lowest degrees). Moreover leximin (resp. leximax)-optimal decisions cannot be separated using the leximax (resp. leximin) SWO, because Leximin-equivalent decisions share the same increasingly arranged utility vector, i.e., they are leximax equivalent.

5.2 The least violated discriminating constraint

Similarly to leximin/leximax, one can imagine a new SWO refining the maximum and based on the notion of fuzzy sets inclusion : the least violated discriminating constraint (LVDC) ordering :

- $\vec{u} >_{\text{LVDC}} \vec{v} \Leftrightarrow \text{Max}_{C_i \in \mathcal{D}(u, v)} u_i > \text{Max}_{C_i \in \mathcal{D}(u, v)} v_i$

This approach consists in comparing the fuzzy sets of satisfied constraints, \mathcal{S}_u and \mathcal{S}_v from the *highest* level-cuts down to the *lowest* ones (contrarily to LSDC which makes the comparison from the bottom to the top), until reaching a level α such $(\mathcal{S}_u)_\alpha \neq (\mathcal{S}_v)_\alpha$. At this level, if $(\mathcal{S}_u)_\alpha \supset (\mathcal{S}_v)_\alpha$, and u is preferred to v ; if $(\mathcal{S}_u)_\alpha \subset (\mathcal{S}_v)_\alpha$, v is preferred to u . Otherwise, the decisions are incomparable and will be considered as indifferent. Two decisions are equivalent, and thus indifferent, if both satisfy all the constraints to the same degree, i.e., when $\mathcal{S}_u = \mathcal{S}_v$. Then

- $\vec{u} >_{LVDC} \vec{v} \Leftrightarrow \exists \alpha \in L$ such that
 - (i) $\forall \beta \in L$ such that $\beta > \alpha$, $(\mathcal{S}_u)_\beta = (\mathcal{S}_v)_\beta$
 - (ii) $(\mathcal{S}_u)_\alpha \supset (\mathcal{S}_v)_\alpha$.

If the constraints are all or nothing (i.e., allowing satisfaction degrees in $\{0,1\}$), $>_{LVDC}$ and $>_{LSDC}$ collapse : both prefer s_u to s_v if and only if all the C_i satisfied by s_v are also satisfied by s_u and there are some C_i satisfied by s_u which are violated by s_v . Both are equivalent to \succcurlyeq_{Pareto} in the non-fuzzy case. If several satisfaction degrees are allowed, \succcurlyeq_{LVDC} is a refinement of \succcurlyeq_{Pareto} . Indeed :

- $\vec{u} >_{Pareto} \vec{v} \Rightarrow \vec{u} >_{LVDC} \vec{v}$

The converse implication is not verified. We only have :

- $\vec{u} >_{LVDC} \vec{v} \Rightarrow \vec{u} \succcurlyeq_{Pareto} \vec{v}$

Finally, LVDC can be expressed using inclusion degrees :

- $\vec{u} >_{LVDC} \vec{v} \Leftrightarrow \text{Min}_{C_i \in \mathcal{C}} (1 - \mu_{\mathcal{S}_u}(C_i)) \rightarrow (1 - \mu_{\mathcal{S}_v}(C_i)) > \text{Min}_{C_i \in \mathcal{C}} (1 - \mu_{\mathcal{S}_v}(C_i)) \rightarrow (1 - \mu_{\mathcal{S}_u}(C_i))$

That is, if the degree of inclusion of \mathcal{S}_v in \mathcal{S}_u is greater than the degree of inclusion of \mathcal{S}_u in \mathcal{S}_v in the sense of the contraposition of Gödel implication.

6. Summary and concluding remarks

The introduced refinements of the maximin optimization strategy in fuzzy optimization are not really new since the leximin ordering is borrowed from the social sciences and the LSDC ordering is borrowed from the nonmonotonic reasoning literature in Artificial Intelligence. However most works in fuzzy optimisation that question the maximin strategy rather adopt max-triangular norm schemes or utilitarian ones and not the proposals made here. The maximin strategy has many advantages. Among others, it can lend itself easily to constraint-propagation techniques, and this is not true for the max-triangular norm schemes or utilitarian ones. By refining the maximin strategy, one may keep some of these advantages and still overcome the lack of discrimination power of the minimum operation when an explicit solution to a flexible constraint problem is needed.

In the paper some nice characterizations of the two considered orderings have been obtained, based on Gödel implication, and fuzzy cardinality respectively. They enable fuzzy ordering relations to be built for the purpose of comparing fuzzy sets, in agreement with the lexicographic and LSDC orderings. Dual refinements of the

maximax strategy have also been laid bare. As a final illustrative example the following table contains 10 fuzzy sets that model rating vectors of 10 solutions to a problem involving 5 flexible constraints.

	C1	C2	C3	C4	C5
a	0.8	0.6	0.7	0.4	0.8
b	0.7	0.6	0.7	0.4	0.8
c	0.7	0.4	0.8	0.4	0.8
d	0.7	0.9	0.6	0.4	0.9
e	0.9	0.7	0.5	0.4	0.9
f	0.8	0.7	0.6	0.4	0.9
g	0.9	0.6	0.7	0.3	0.9
h	0.7	0.5	0.8	0.3	0.9
i	0.6	0.5	0.7	0.3	0.9
j	0.0	0.0	0.0	0.5	0.0

As shown in Figure 8, each decision is optimal, depending on the ordering notion that is used. It should be noticed that d is optimal for all orderings, and that there are decisions which are both LVDC-optimal and maximin without being LSDC-optimal (resp. LSDC and maximax, without being LVSC-optimal); viz. solution e (resp. f). Another advantage of the maximin (or maximax) strategy is that it copes with redundant constraints due to the idempotency of the min. This is no longer true for the leximin ordering which is sensitive to the repetition of constraints. Noticeably, constraint propagation makes implicit constraints explicit and thus produces redundant constraints. They are useful to eliminate infeasible solutions. The solutions eliminated via the min-based propagation step are infeasible in the sense of the leximin criterion too. However these redundant constraints should not be used in the leximin ordering. By repeating a constraint a sufficient number of times, one may make a non-leximin optimal solution optimal in a very artificial way. The leximin ordering makes sense for independent constraints. This limitation does not exist for the LSDC ordering which is not affected by the presence of redundant constraints. But only a strict partial order is obtained while the leximin ordering is complete. If a single solution is needed a leximin optimal solution sounds reasonable; if a set of good solutions is required, the LSDC ordering would rather be used; if all solutions must be computed, it is more convenient to exploit the maximin propagation methods for fuzzy constraints, as described in [9,10].

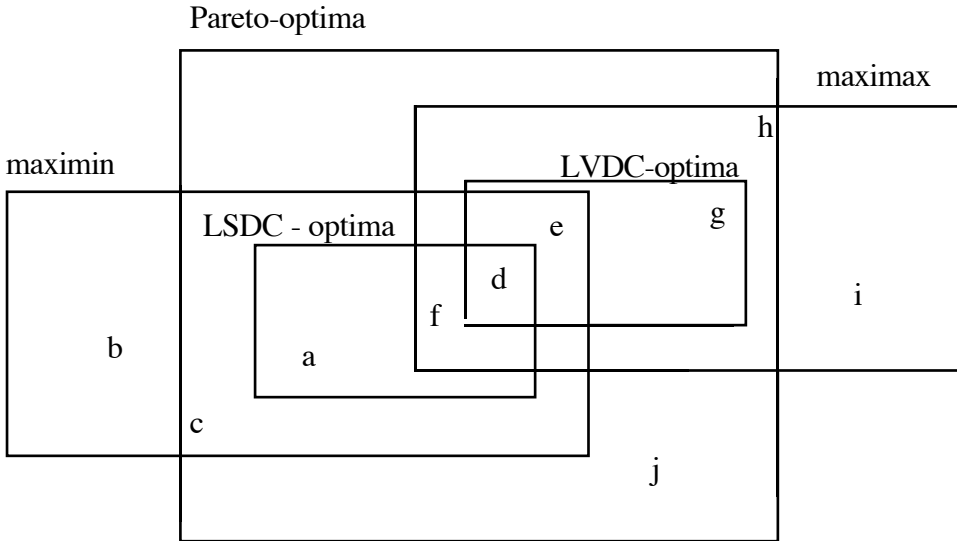

Figure 8.

Appendix: A refresher on fuzzy cardinality.

Let F be a fuzzy set on a finite set X . One of the definitions of fuzzy cardinality $|F|$ due to Zadeh [36] proposes the fuzzy integer

$$\mu_{|F|}(n) = \max \{ \alpha, |F_\alpha| = n \} \text{ for any non-negative integer } n.$$

where the α level cut of F is $|F_\alpha| = \{x, \mu_F(x) \geq \alpha\}$ for $\alpha > 0$. Not all fuzzy sets of the integers can represent such a fuzzy cardinality. Indeed, a fuzzy cardinality is normalized: $\mu_{|F|}(n) = 1$ for some $n = n_0$. Moreover if $S(|F|) = \{x, \mu_{|F|}(x) > 0\}$ is the support of $|F|$ then for any $n > m$ in $S(|F|)$, $\mu_{|F|}(n) > \mu_{|F|}(m)$. Note that there may be holes in $|F|$, that is, $n > k > m$ with $\mu_{|F|}(n) > \mu_{|F|}(m) > 0$ but $\mu_{|F|}(k) = 0$.

If F and G are two fuzzy subsets of X then consider

$$\Pi(|F| < |G|) = \max \{ \alpha > 0, |F_\alpha| < |G_\alpha| \}$$

The following properties hold:

i) $\Pi(|F| < |F|) = 0$, since $\alpha > 0$ implies $|F_\alpha| = |F_\alpha|$;

ii) $|F_\alpha| = \max(|F|_\alpha)$ since $\mu_{|F|}$ decreases in its support;

iii) If $\Pi(|F| < |G|) = \Pi(|G| < |F|) = \alpha$ then this value is 0. Indeed suppose $\alpha > 0$. Then at the same time $|F_\alpha| < |G_\alpha|$ and $|G_\alpha| < |F_\alpha|$ would hold.

iv) $|F| = |G|$ if and only if $\Pi(|F| < |G|) = \Pi(|G| < |F|)$. The only if part is obvious. The if part is almost so since $\Pi(|F| < |G|) = \Pi(|G| < |F|) = \beta$ means that $|F_\alpha| \geq |G_\alpha|$ and $|G_\alpha| \geq |F_\alpha|$ for all $\alpha > \beta$ and it is known that $\beta = 0$.

ACKNOWLEDGEMENTS: The authors are grateful to an anonymous referee for careful and detailed advice that helped us revise the manuscript.

References

- [1] Bandler W. Kohout L. Fuzzy power sets and fuzzy implication operators. *Fuzzy Sets and Systems* 4(1980) 183-190
- [2] Bellman R.E. , and Zadeh L.A., "Decision-making in a fuzzy environment," *Management Science* 17 (1970) 141-164, .
- [3] Benferhat S., Cayrol C., Dubois D., Lang J., Prade H. Inconsistency management and prioritized syntax-based entailment. *Proceedings of the 13th. Int. Joint Conf. on Artificial Intelligence*, Chambéry, France (1993) 640-645
- [4] Brewka G., Preferred subtheories: an extended logical framework for default reasoning. *Proceedings of the 11th. Int. Joint Conf. on Artificial Intelligence*, Detroit, Mich (1989) 1043-1048.
- [5] Cayrol C., Royer V., Saurel C., Management of preferences in assumption-based reasoning. In B. Bouchon-Meunier et al., eds., *Proceedings of IPMU'92* , Lecture Notes in Computer Science n° 682, (Springer Verlag, Berlin, 1993) 13-22.
- [6] Cholewa W. Aggregation of fuzzy opinions - an axiomatic approach. *Fuzzy Sets and Systems*, 17 (1985) 249-258
- [7] De Baets B. Ordering alternatives in MCDM problems. In: Da Ruan et al. Eds, *Fuzzy logic and Intelligent Technologies in Nuclear Science* (World Scientific, Singapore, 1994) 48-55
- [8] Descottes Y., Latombe J. C. Making compromises among antagonist constraints. *Artificial Intelligence*, 27 (1985) 149-164.
- [9] Dubois D., Fargier H., Prade H., Propagation and Satisfaction of flexible constraints, In: Yager R.R. and Zadeh L.A., eds., *Fuzzy Sets, Neural Networks and Soft Computing*, (Van Nostrand Reinhold, New-York, 1994) 166-187
- [10] Dubois D., Fargier H., Prade H. Flexible constraint satisfaction with application to scheduling problems. Revised version of Report 93-30, IRIT, Université Paul Sabatier, Toulouse, France (1995).
- [11] Dubois D. Koning J.L. Social choice axioms for fuzzy set aggregation. *Fuzzy Sets and Systems*, 43 (1991) 257-274
- [12] Dubois D., Lang J., Prade H., Inconsistency in possibilistic knowledge bases: to live or not live with it. In: L.A. Zadeh, J. Kacprzyk, eds. *Fuzzy Logic for the Management of Uncertainty* (Wiley, New-York, 1992) 335-351.
- [13] Dubois D., Lang J., Prade H. Possibilistic logic. In: D. Gabbay et al. Eds, *Handbook of Logic in Artificial Intelligence and Logic Programming*, Vol. 3 (Oxford Science Pub., Oxford, 1994) 439-513.
- [14] Dubois D. and Prade H. Fuzzy cardinality and the modeling of imprecise quantification, *Fuzzy sets and Systems*, 16 (1985) 199-230
- [15] Dubois D., and Prade H. (with the collaboration of Farreny H., Martin-Clouaire R., Testemale C.) *Possibility Theory – An Approach to Computerized Processing of Uncertainty*. (Plenum Press, New York, 1988).
- [16] Dubois D. and Prade H. Fuzzy rules in knowledge-based systems. In: R.R. Yager, L.A. Zadeh, Eds, *An Introduction to Fuzzy Logic Applications in Intelligent Systems*. (Kluwer Acad. Pub. , Dordrecht, 1992) 45-68.
- [17] Dubois D. and Prade H. Decision-making under fuzzy constraints and fuzzy criteria - mathematical programming vs. rule-based system approach. In: M. Delgado et al., Eds., *Fuzzy Optimization* (Physica-Verlag, Heidelberg, 1994) 21-33
- [18] Fargier H., Lang J., Schiex T. Selecting preferred solutions in fuzzy constraint satisfaction problems. *Proc. 1st European Congress on Fuzzy and Intelligent*

Technologies (EUFIT'93), Aachen, F.R.G., (ELITE-Foundation, Aachen, 1993) 1128-1134.

- [19] Fargier H. *Problèmes de satisfaction de contraintes flexibles: application à l'ordonnancement de production* (In French). Ph.D. Thesis, Université Paul Sabatier, Toulouse (1994) 314p.
- [20] Freuder E.C. Partial constraint satisfaction. In *Proceedings of the 11th Inter. Joint Conf. on Artificial Intelligence*, Detroit, Michigan, Aug. 20-25 (1989) 278-283.
- [21] Freuder E. C. Wallace R.J. Partial Constraint Satisfaction. *Artificial Intelligence* 58(1992) 21-71.
- [22] Fung L.W. Fu, K.S. An axiomatic approach to rational decision-making in a fuzzy environment. In L.A. Zadeh, K.S. Fu, K. Tanaka, M. Shimura, eds. *Fuzzy Sets and their Applications to Cognitive and Decision Processes*, (Academic Press, New-York, 1975) 227-256
- [23] Geffner H. *Default reasoning: causal and conditional theories*. (MIT Press, Cambridge, Mass. 1992)
- [24] Keeney R.L., Raiffa H. *Decisions with Multiple Objectives: Preferences and Value Tradeoffs*. (John Wiley & Sons, New York, 1976)
- [25] Lang J. Possibilistic logic as a framework for min-max discrete optimisation problems and prioritized constraints. In: P. Jorrand, J. Kelemen, eds, *Fundamentals of Artificial intelligence Research Lecture Notes in Computer Science*, vol. 535, (Springer Verlag, Berlin, 1991) 112-126.
- [26] Mackworth A.K. Consistency in networks of relations. *Artificial Intelligence*, 8 (1977) 99-118.
- [27] Montanari U. Network of constraints: fundamental properties and application to picture processing. *Information Sciences*, 7 (1974) 95-132.
- [28] Montero de Juan F. A note on Fung-Fu's theorem. *Fuzzy Sets and Systems*, 17(1985) 249-258
- [29] Moulin H. *Axioms of Cooperative Decision-Making*. (Cambridge Univ. Press, Cambridge, U.K., 1988)
- [30] Nebel B. Syntax-based approaches to belief revision. In P. Gardenfors, Ed. *Belief Revision* (Cambridge Univ. Press, Cambridge, U.K., 1992) 52-88
- [31] Schiex T. Possibilistic constraint satisfaction problems or how to handle soft constraints. *Proc. of the 8th Conf. on Uncertainty in Artificial Intelligence*, Stanford, July 17-19 (1992) 268-275.
- [32] Yager R.R. A new methodology for ordinal multiobjective decisions based on fuzzy sets. *Decision Sciences* 12 (1981) 589-600.
- [33] Yager R.R. On the logical representation of social choice, *Cybernetics & Systems*, 21 (1990) 575-580
- [34] Zadeh L.A. Calculus of fuzzy restrictions. In L.A. Zadeh, K.S. Fu, K. Tanaka, M. Shimura, eds. *Fuzzy Sets and their Applications to Cognitive and Decision Processes*, (Academic Press, New-York, 1975) 1-39.
- [35] Zadeh L.A. Fuzzy sets as a basis for a theory of possibility. *Fuzzy Sets and Systems*, 1 (1978) 3-28.
- [36] Zadeh L.A. A theory of approximate reasoning. In J.Hayes et al., Eds, *Machine Intelligence*, Vol. 9 (Wiley & Sons, New-York, 1979) 149-174