



HAL
open science

Design and construction of the first ELM resilient long pulse ICRH antenna for WEST

Jean-Michel Bernard, Patrick Mollard, Vincent Bruno, Zhaoxi Chen, Jean-Marc Delaplanche, Etienne Delmas, Fabien Ferlay, Jean-Claude Hatchressian, Walid Helou, Julien Hillairet, et al.

► To cite this version:

Jean-Michel Bernard, Patrick Mollard, Vincent Bruno, Zhaoxi Chen, Jean-Marc Delaplanche, et al.. Design and construction of the first ELM resilient long pulse ICRH antenna for WEST. Fusion Engineering and Design, 2017, 123, pp.217-222. 10.1016/j.fusengdes.2017.05.024 . hal-04037807

HAL Id: hal-04037807

<https://hal.science/hal-04037807v1>

Submitted on 20 Mar 2023

HAL is a multi-disciplinary open access archive for the deposit and dissemination of scientific research documents, whether they are published or not. The documents may come from teaching and research institutions in France or abroad, or from public or private research centers.

L'archive ouverte pluridisciplinaire **HAL**, est destinée au dépôt et à la diffusion de documents scientifiques de niveau recherche, publiés ou non, émanant des établissements d'enseignement et de recherche français ou étrangers, des laboratoires publics ou privés.



Distributed under a Creative Commons Attribution 4.0 International License

Manufacturing and test of the first ELM resilient long pulse ICRH antenna for WEST

Jean-Michel BERNARD¹, Patrick MOLLARD¹, Vincent BRUNO¹, Zhaoxi CHEN¹, Jean-Marc DELAPLANCHE¹, Etienne DELMAS¹, Fabien FERLAY¹, Jean-Claude HATCHRESSIAN¹, Walid HELOU¹, Julien HILLAIRET¹, Tuong HOANG¹, Gilles LOMBARD¹, Céphise LOUISON^{1,5}, Frank SAMAILLE¹, Yuntao SONG², Karl VULLIEZ⁴, Jean-Marc VERGER¹, Yongsheng WANG², Xinlian WU³, Qingxi YANG², Dapeng YIN³

^{1.} CEA, IRFM, F-13108 Saint Paul-lez-Durance, France.

^{2.} Institute of Plasma Physics, Chinese Academy of Sciences, Hefei, Anhui, China

^{3.} KEYE workshop, Hefei, Anhui, China

^{4.} Laboratoire d'étanchéité, DEN/DTEC/SDTC, CEA, 2 rue James Watt 26700 Pierrelatte, France

^{5.} Aix-Marseille University, CNRS, Institute of Movement Sciences, Marseille, France

One of the key missions of the Ion Cyclotron Resonant Heating (IRCH) system for WEST is to provide sufficient RF heating power in order to obtain a heat flux on the divertor target of 10MW/m² during 1000 s and 20 MW/m² during a few tens of seconds. Based on the experience acquired in Tore Supra, the ICRH system has been upgraded for long pulse operation and Edge Localized Modes (ELM) resilience. To achieve this performance, three antennas have been designed through a European collaboration and are now under fabrication at CAS/ASIPP, at the Keye Company, Hefei, in China, within the framework of the Associated Laboratory IRFM-ASIPP. This paper describes the electrical and mechanical design of the antenna, together with the main manufacturing steps and leak test procedure used for validating the water-cooled components. Accessibility and maintenance studies on WEST have been performed with the help of virtual reality. The first ICRH antenna was delivered at Cadarache in July 2016, and is foreseen to be installed on WEST in 2017.

Keywords: ICRH antenna, CW operation, leak test, strap, Faraday screen, WEST, ITER

1. Introduction

The WEST ICRH system has to deal with two challenging issues that no other ICRH system before ITER has faced simultaneously so far, i.e. ELMs resilience and Continuous Wave (CW) RF operation [1]-[4]. The technical solution chosen to meet the objectives of the WEST scenarios was to build three new antennas based on the RF design successfully tested in short pulses in 2007 with the Tore Supra prototype antenna [5]. This paper describes the mechanical aspects regarding the CW operation constraint on the WEST ICRH antennas. The main difficulties of such assembly are related to the water cooling circuits. All parts of the antenna are water-cooled which enforce complex processes during fabrication phases. A presentation of the intermediate tests performed during fabrication of each sub assembly is made, and details of the processes used are given.

2. ICRH antenna design and construction

The goal of the WEST ICRH system is to operate at a power level of 9 MW during 30 s or 3 MW during 1000 s using three antennas (1 MW/antenna for 1000 s). The antenna electrical circuit is based on the load-resilient concept consisting of a toroidal array of resonant double loops with low impedance junction Conjugate-T and internal vacuum capacitors [6] integrated in coaxial lines (see Fig. 1).

The conjugate-T structure of the antenna is composed of two poloidal current straps short-circuited on one side on the Faraday Screen (FS) and connected in series to a variable capacitor at the other side. The matching unit [5], composed of two capacitors connected side by side, is fed by a two-stage quarter-wave length impedance transformer (conversion from the 30 Ω feeding line to the 3 Ω T-junction impedance).

Following capacitor failures that occurred during ICRH operation on Tore Supra, an analysis were performed jointly with the capacitor manufacturer. It highlighted that failures were caused by over-current and over-voltage in the capacitors during disruption phases. In order to avoid reproducing such failures, the WEST ICRH CODAC system has been upgraded to reduce the response time of the current and voltage limitation system from 2 ms to 100 μs.

The antenna structure is subdivided in six sets of components: the front face (FS, straps, lateral bumpers), the matching unit (capacitors, actuating system), the housing box and bridges, the impedance transformer (feeding lines, auxiliary pumping), the support structure (rear flange, bellows, internal and external mechanical structure), the service stub with the RF windows, and the instrumentation (RF probes, arc detection system) (see Fig. 2 **Erreur ! Source du renvoi introuvable.** for a side view). Total antenna length is 3.5 m.

For this antenna two different water cooling loops are used to evacuate the RF losses and radiated heat flux. The main reason for the use of two loops is that the RF capacitor rating temperature is 70 °C. The temperatures and pressures shown below are used during the experiments:

- Water loop 1 at 20 °C / 7 bar, used for straps, capacitor flanges, bridge, inner conductors of feeding lines.
- Water loop 2 at 70 °C / 30 bar used for FS, housing box, outer conductors of feeding lines, lateral bumpers.

During the baking phase of the machine, a dedicated process is used for the antenna, taking into account the capacitors temperature range. Loop 1 remains stable at

nominal value (20 °C), while the temperature of the loop 2 is increased to 200 °C during a few days. To insure efficient outgassing of the materials, a dedicated auxiliary pumping system has been added at the input of the RF transformer (on the high impedance part of the impedance transformer see Fig. 1 and Fig. 2). During the baking phase the outer conductor cooling pipes of the RF transformer are not cooled (isolated by dedicated valves) to allow conducting heating from the rest of the antenna. The cooling circuits of this antenna are dimensioned [3] to be compatible with CW operation.

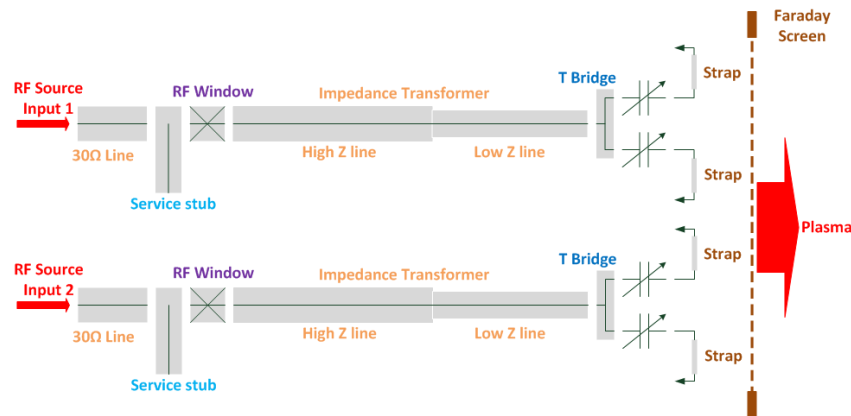

Fig. 1: Electrical Scheme of the CW WEST ICRH Antenna.

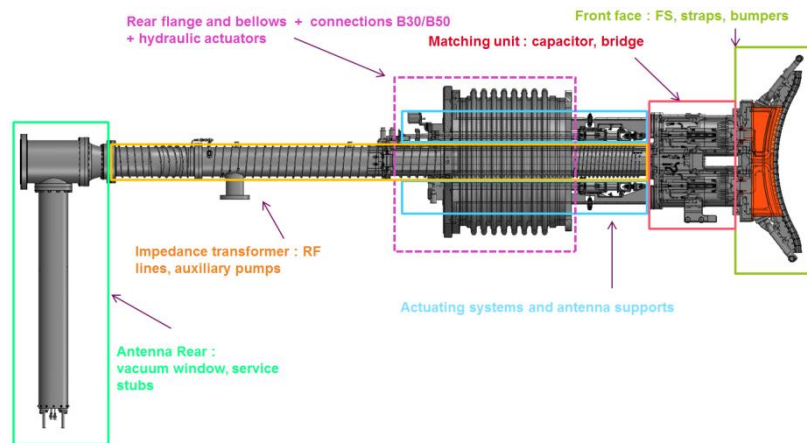

Fig. 2: Cut-view of the CW WEST ICRH Antenna.

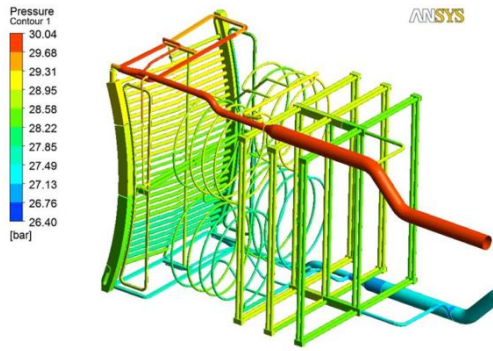

Fig. 3: View of the front face water circuits.

All components subject to RF power are water-cooled, e.g. the two electrodes of the capacitors used in the resonant circuit. One capacitor electrode is cooled through the straps (the fixed electrode), while the other one (the movable electrode) is cooled through the inner conductor of the RF transformer (use of loop 1).

The straps radiate the RF waves and feed the capacitors with water. The complex geometry of the straps induces manufacturing difficulties: the straps are curved and have several angles in order to keep the gap with respect to the Faraday screen as constant as possible. As the cooling channels are drilled into the straps, the manufacturing sequence is important to have a good precision. The procedure is the following:

- 1- The raw blocks (SS 316L) are welded together and a massive block is kept in the middle to minimize deformation (Fig. 4);
- 2- The outer faces are shaped (Fig. 4);
- 3- Fig. 4);
- 4- The cooling channels are 5D machined following curved shapes (Fig. 5);
- 5- The cooling channel covers are welded;
- 6- The central block is removed;
- 7- Then, the final machining is done (chamfers, radius, etc.) (Fig. 6).

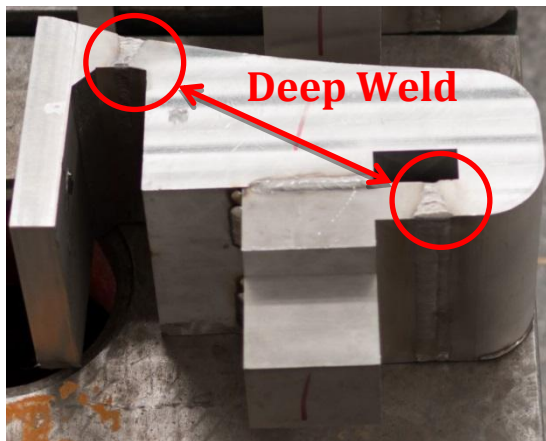

Fig. 4: Rough material for the strap, welded and shaped.



Fig. 5: Drilling of the cooling channels.

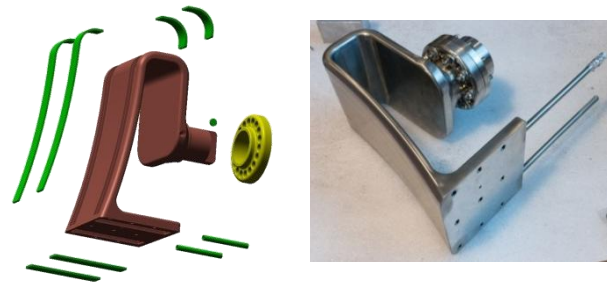

Fig. 6: (left) 3D exploded view / (right) finished strap.

The covers are bended plates (Fig. 6 left) before welding. The manufacturing process was established by the manufacturer in order to minimize deformations during machining and welding (Fig. 4).

One of the most complicated components of the antenna is the Faraday Screen (FS) (Fig. 7). It is made of machined Stainless Steel (SS) parts. Side plates are machined to include grooves and welded covers, and the horizontal bars are welded on vertical septum and side plates. Both the vertical and horizontal septa are water cooled.

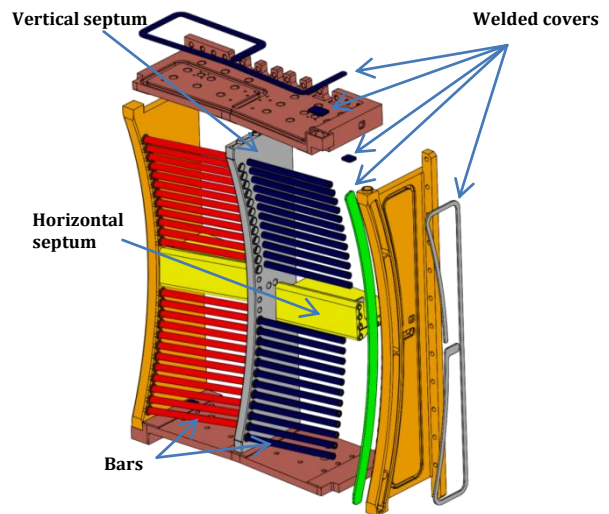

Fig. 7: Exploded 3D View of the FS.

To assemble the sub-elements of the FS with high precision and low deformation, laser welding would have been a well-suited solution. However in our case, the welding paths follow curves all around the component, which complicates the process (speed, angle...). TIG welding was therefore chosen instead to simplify the welding process. The time duration spent for the overall welding phase was around ten days for the FS. The welding sequence was developed and validated on mock-ups in order to minimise the deformation of the parts and to ensure perfect tightness. During welding, the temperature of the component was kept below 200°C, maintained by clamps and welded by alternate 50 mm seams. Then, the clamps were removed once the temperature had cooled down. **Erreur ! Source du renvoi introuvable.** shows the first finished FS.

After the welding sequence was completed, 3D measurements were done: dimensions, flatness, perpendicularity, parallelism and roughness required for the strap positioning and for the silver coating were measured. Key Company is equipped with a laser-tracking tool, a laser scanning arm and a coordinate measuring machine. Once the tolerances were obtained, a leak test was performed on the water circuit to control the tightness of the welds and the material porosity (see the leak test procedure in section 3).



Fig. 8: Finished FS pre-mounted with straps

The total number of components integrated into the antenna is described in Table 1. More than 2000 different parts have been machined for the six subassemblies of one antenna.

Sub-assembly	Number of machined parts
Front face	543
Matching capacitor	276
Matching unit	273
Impedance transformer	738
Support structure	132
Lateral bumper	122
TOTAL	2084

Table 1: Number of components for one antenna

A blank assembly of the antenna was performed in May 2016 at the manufacturer's site in Hefei (see Fig. 9:

Antenna blank assembly at ASIPP.. This allowed verifying and controlling the compatibility of all subassemblies.



Fig. 9: Antenna blank assembly at ASIPP.

3. Leak test procedure used for the WEST ICRH antenna

All components of the ICRH antenna have to be tested for leak tightness before their installation on the WEST port plugs [9], [10], [11].

Due to the mechanical complexity and the presence of different cooling circuits, leak tests have been performed all along the manufacturing process to qualify the antenna subassemblies under operational constraints (high vacuum and temperature).

- Each welded assembly has been checked first at room temperature, with a conventional leak test by putting the component under vacuum and spraying Helium (He) gas.
- Taking into account that the operational temperature is 200 °C during the baking phase, each subassembly undergoes thermal cycles in a test tank, with water circuits pressurized with He. Three temperature cycles are performed with ramp-up and ramp-down rate of 10 °C / hour (as described in Fig. 10). Two He gas pressurizations are performed at each stage at 200 °C and room temperature.

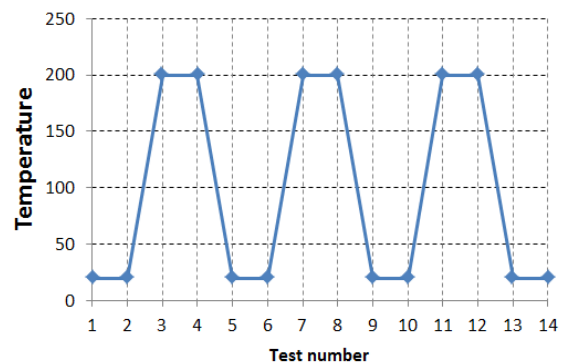

Fig. 10: Temperature cycle for leak tightness test.

After these preliminary tests were achieved, all surfaces of the RF facing components were silver coated to minimize the RF losses. The coated surfaces have been specified with a roughness Ra between 1.6 and 3.2. The silver-coating thickness is 40 µm, i.e. around three times the skin depth at the frequency used.

Once the antenna will be fully assembled, a full leak test on the dedicated TITAN test bed [7], [8] will be performed.

4. Accessibility on Tokamak

The CEA IRFM is equipped with a Virtual Reality (VR) room and real time simulation software to check the assembly and the maintenance feasibility. The virtual scale-one mock-up helps verifying the integration of components and to avoid possible collisions. It allows operators to practice the assembly as well. This process allows optimisation of the accessibility without real platform and antenna.

The human accessibility to the antenna as installed on the WEST tokamak was done with the XDE software and Unity3D with an Oculus Rift. Hereafter, as an example, we present the antenna accessibility study from the platform (Fig. 11). An avatar can be controlled in real-time by a human in the first person with contact feedback to validate accessibility of capacitor command (see [12] for more detail about the tools and the process). These studies are a part of an iterative process that take into account the design and interfaces with other components of the Tokamak.



Fig. 11: Human in the loop for accessibility study.

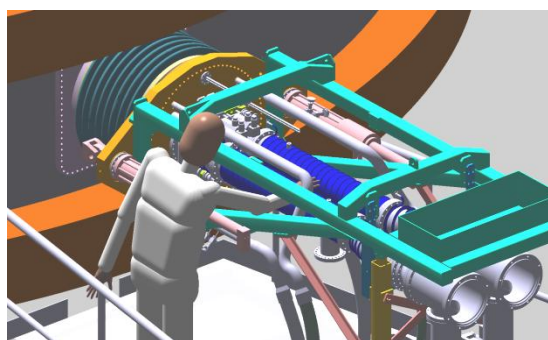

Fig. 12: Avatar on the platform.

5. Conclusions

After one year for design, one year for 2D detail drawings and more than one year for fabrication phases, the first CW ELM-resilient ICRH antenna has been manufactured by a joint team, in the framework of the Associated Laboratory IRFM-ASIPP, and in collaboration with Keye Company in Hefei. This antenna is fully water cooled to sustain CW operation at 1 MW. More than 2000 parts have been machined, 15

subassemblies have been leak tested at high temperature and 187 subassemblies have been leak tested at room temperature, following specific procedures. The RF surfaces of the components have been silver coated. This first antenna is now under RF commissioning on TITAN test bed [7], [8], to prepare the matching system and validate all diagnostics. The machining of the second and third antenna is ongoing.

Acknowledgements

The authors acknowledge the assistance of the joint team from ASIPP, IRFM and of the Keye Company, who strongly supported the project during the manufacturing phase, in terms of facilities and manpower.

References

- [1] Z. Chen et al., *Fusion Eng. Des.* **94** (2015) 82
- [2] W. Helou et al., *Fusion Eng. Des.* **96-97** (2015) 473-476
- [3] K. Vulliez et al., *Fusion Eng. Des.* **96-97** (2015) 611
- [4] J. Hillairet et al., *Proc. 21st Topical Conf. on Radiofrequency Power in Plasmas, Lake Arrowhead, CA* (2015). *AIP Conf. Proc.* **1689** (2015) 070005.
- [5] K. Vulliez et al., *Nuclear Fusion*, **48**, (2008) 065007
- [6] G. Bosia, *Fusion Sci. Technol.* **43** (2003) **153-160**.
- [7] J.M. Bernard et al., *Fusion Engineering and Design* **86** (2011) **876-879**.
- [8] J.M. Bernard et al., *Proc. 19th Topical Conf. on Radiofrequency Power in Plasmas, Newport RI* (2011) *AIP Conf. Proc.* **1406** (2011) 49.
- [9] J.J. Cordier et al., *Fusion Engineering and Design* **51-52** (2005) 577-581.
- [10] F. Samaille et al., *Fusion Engineering and Design* **75-79** (2000) 949-954.
- [11] M. Chantant et al, *Fusion Engineering and Design* **98-99** (2015) 1250-1255.
- [12] C. Louison, F. Ferlay, D. Keller, D. R. Mestre: Operators' Accessibility Studies using Virtual Reality, this conference.