

# 3D printed polymer-based two-phase cooling system for power electronic devices

**Tony Gerges**<sup>1</sup>, Alexandre Marie<sup>2</sup>, Thilini Wickramasinghe<sup>1</sup>, Vincent Semet<sup>1</sup>, Philippe Lombard<sup>1</sup>, Stéphane Lips<sup>2</sup>, Valérie Sartre<sup>2</sup>, Bruno Allard<sup>1</sup>, Michel Cabrera<sup>1</sup>

<sup>1</sup>Univ Lyon, INSA Lyon, Université Claude Bernard Lyon 1, École Centrale de Lyon, CNRS, Ampère, UMR5505, 69621 Villeurbanne, France

<sup>2</sup>Univ Lyon, INSA Lyon, CNRS, CETHIL UMR5008, F-69621 Villeurbanne, France

***tony.gerges@insa-lyon.fr***



# Overview

---

- 1. Context & state of the art on 3D printed heat sinks**
- 2. 3D Plastronics technology**
- 3. Polymer 3D printed heat pipe evaporator & thermal characterization**
- 4. Hybrid 3D printed heat pipe evaporator & thermal characterization**
- 5. Conclusion & Future work**

# 1. Context

**Power electronics are widely used in many industrial sectors :**

**Transport:**



Automotive



Air transport



Train transport

**Renewable energy:**



Solar Energy



Wind energy

**To improve the performance of these converters/inverters it is necessary to use high power density components**

# 1. GaN transistors

## GaN transistors:

- High power density (small footprint)
- High breakdown voltage
- Reduced power requirements
- High thermal conductivity

## Advantage of maintaining a low temperature:

- Preventing thermal runaway
- Increasing system performance & circuit reliability
- Reducing losses

**For an optimal functioning, GaN transistors need a cooling system : Heat sinks**

**Among heat sinks, heat pipes offer an efficient cooling solution for high power density components with localized hot spots, which is the case of GaN transistors.**

# 1. Heat pipe: Principle and standard configuration

## Standard configuration

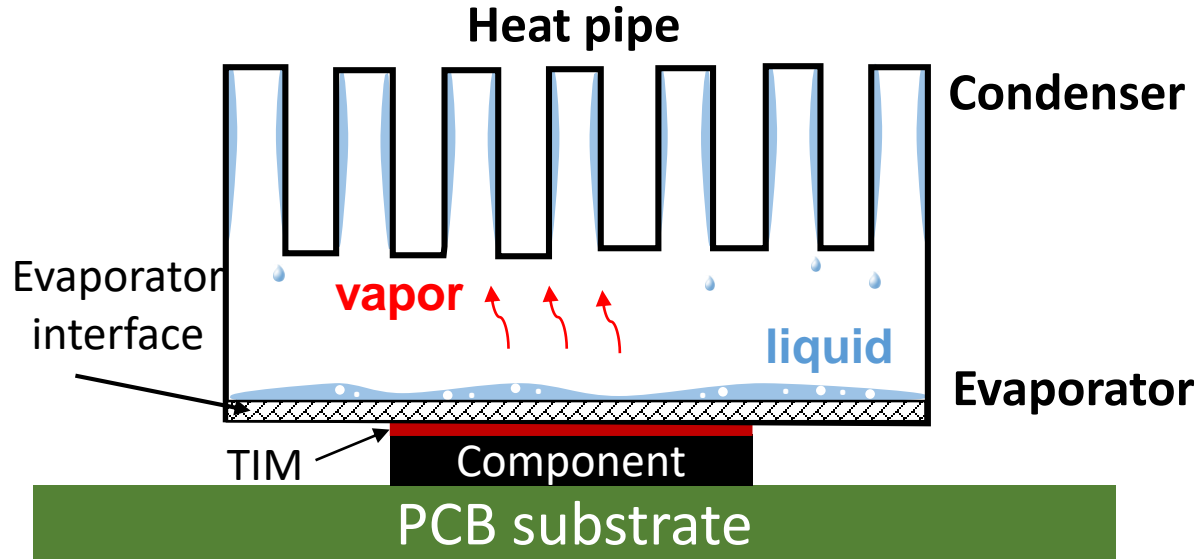

### Heat pipes are:

- Based on liquid-vapor phase-change process of a liquid to transfer the high dissipate heat flux to a remote heat sink (condenser).
- Mainly made of metal:
  - Copper (high thermal conductivity).
  - Aluminum (lightweight).

A TIM is used to improve heat transfer out of electronic components.

**In general heat pipes are fabricated with metal using conventional methods or, recently, 3D printing (Additive manufacturing)**

TIM : Thermal Interface Material

# 1. Additive manufacturing: benefits

- Offers an alternative technique for a heat-sink implementation.
- Presents advantages to overpass limitations imposed by conventional manufacturing:
  - easy customization of the design.
  - High conception flexibility for prototyping
  - Ability to produce complex 3D geometries
  - Validation of functions before mass production
  - Rapid & low cost

**In literature, the use of Metal Additive Manufacturing, and Polymer additive manufacturing to make customized heat sinks with different materials was reported**

# 1. Heat sinks fabricated with metal additive manufacturing

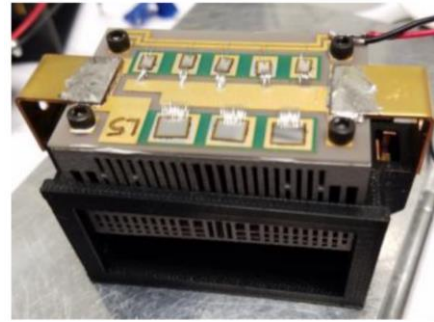
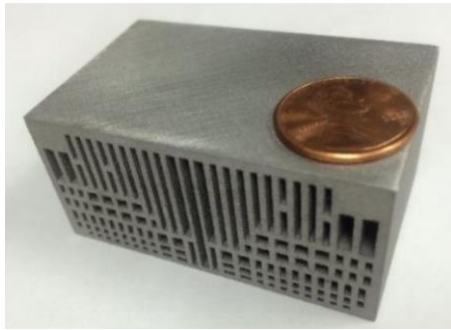

3D printed Aluminum air-cooled heat sink<sup>1</sup>

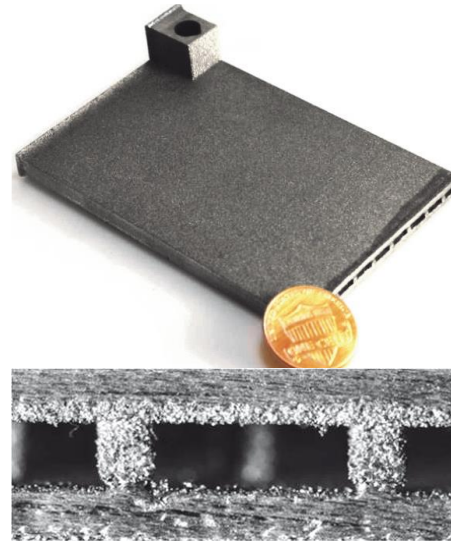

Two-phase Stainless steel vapor chamber<sup>2</sup>



Aluminum 3D printed heat-pipe<sup>3</sup>

## Benefits:

- High thermal conductivity of the metals
- Lightweight (Aluminum)

## Limitations:

- Requires inert atmosphere to prevent oxidation
- High cost fabrication
- Chemically incompatible with water (Aluminum)

<sup>1</sup> Wu et al., IEEE ITEC Conf., 2017

<sup>2</sup> Ozguc et al., 18th IEEE ITherm Conf., vol. 2, 2019

<sup>3</sup> Wits et al., 24th IEEE Thermnic workshop. 2018

# 1. Heat sinks fabricated with polymer additive manufacturing

## Active heat sinks

### Liquid jet impingement cooling

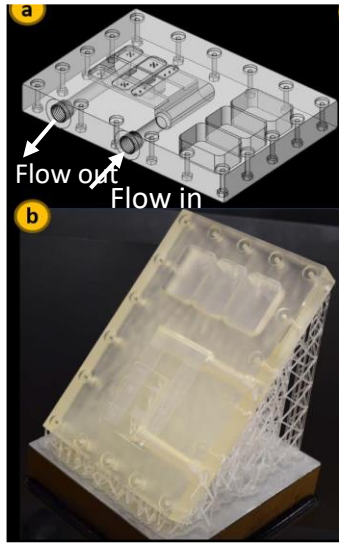

3D printed SLA heat sink<sup>1</sup>

### Air jet impingement cooling

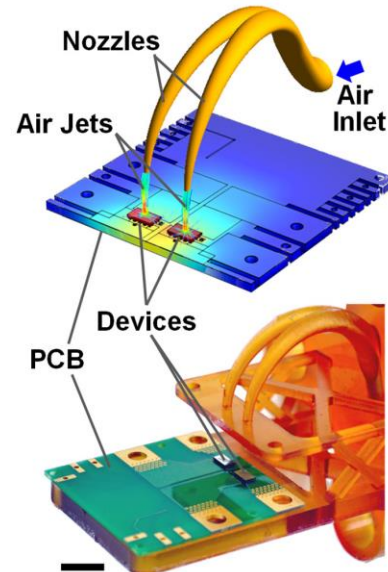

3D printed nozzles<sup>2</sup>

- Need an external power input

## Passive heat sinks



3D printed polymer filled with Graphene nanoplatelets<sup>3</sup>

- Require the use of specific polymer filled with charges to increase the thermal conductivity of polymer
- Not efficient as metal

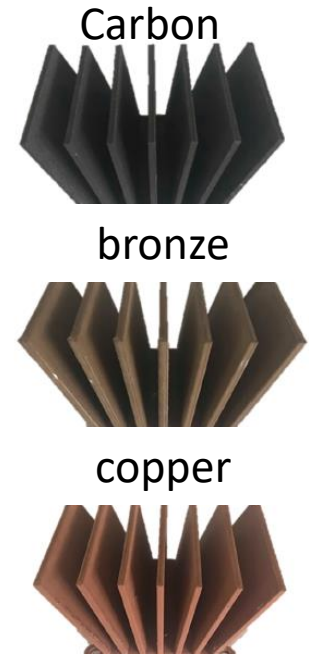

3D printed heatsinks using charged filaments<sup>4</sup>

➤ The manufacture of polymer 3D printed heat pipes is poorly studied in the literature

<sup>1</sup> Michalak et al., 19th IEEE ITherm Conference, vol. 2020-July, pp. 547-557

<sup>2</sup> Kwon et al., IEEE Trans. Components, Packag. Manuf. Technol., vol. 10, no. 2, 2020

<sup>3</sup> Jing et al. Chemical Engineering Journal 402 (2020) 126218

<sup>4</sup> Timbs et al. Thermal Science and Engineering Progress 22 (2021) 100848



# 1. Objectives

To develop an efficient & ultra lightweight heat pipes combining the thermal properties of the **metal** with the properties of the **polymer** using 3D-printing

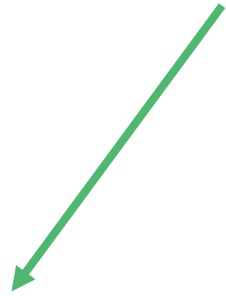

High thermal conductivity

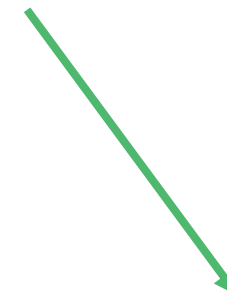

- Lighter weight
- Low-cost fabrication
- Compatible with water



**3D Plastronics**

## 2. 3D Plastronics



Plastic part

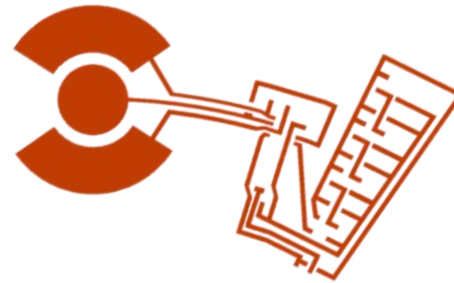

Electronic circuit

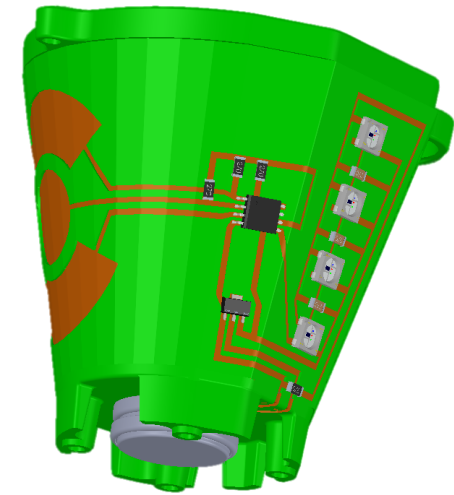

3D circuit

### 3D plastronics allows:

- Better integration of multiple functions in one device
- Integration of heterogeneous functionalities: electronic, mechanical, thermal
- Facilitates assemblies by reducing the number of components

\*T. Gerges et al., J3eA Volume 21, JPCNFM 2021, <https://doi.org/10.1051/j3ea/20221017>  
 T. Gerges et al., J3eA Volume 21, CETSIS 2021, <https://doi.org/10.1051/j3ea/20222047>

# 3. Polymer evaporator: Configuration

## Standard configuration

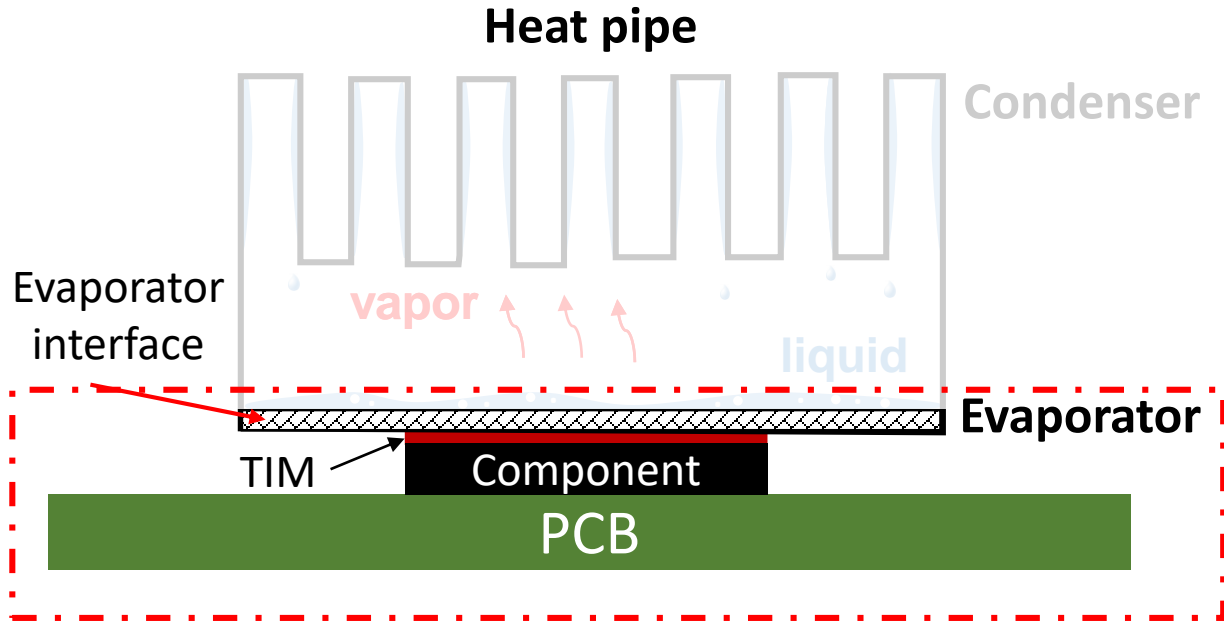

Thermal Interface Material (TIM) between the metallic evaporator and the component

## Polymer 3D printed evaporator configuration:

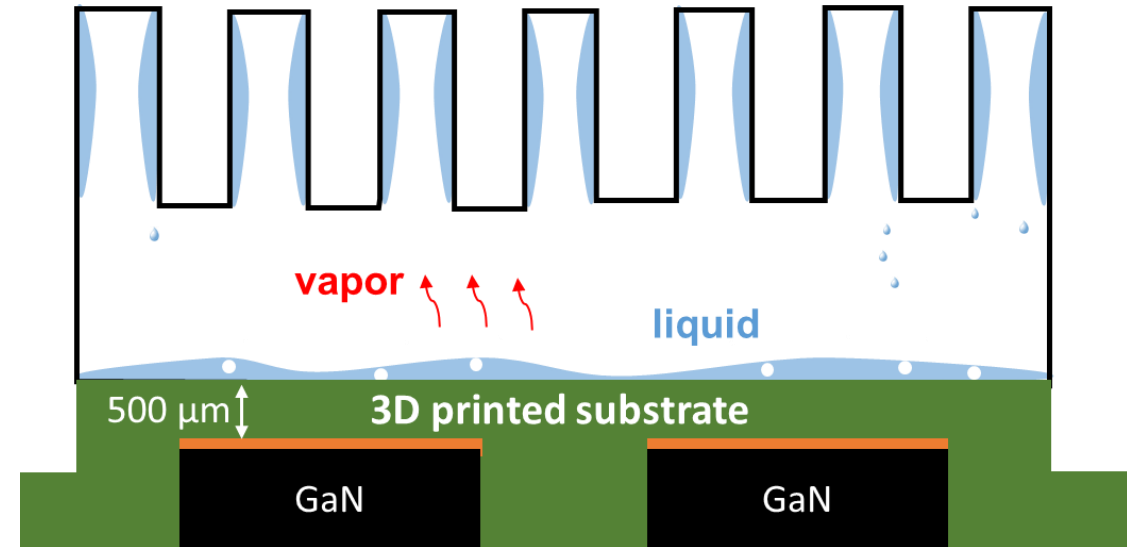

- The PCB is replaced by a 3D printed polymer substrate integrating the electronic components.
- 3D plastronics is used to manufacture the electronic circuit
- Thermal interface is made of polymer (thickness: 500 μm)
- No need for a TIM

# 3. Polymer evaporator: 3D design

## Polymer 3D Evaporator design:

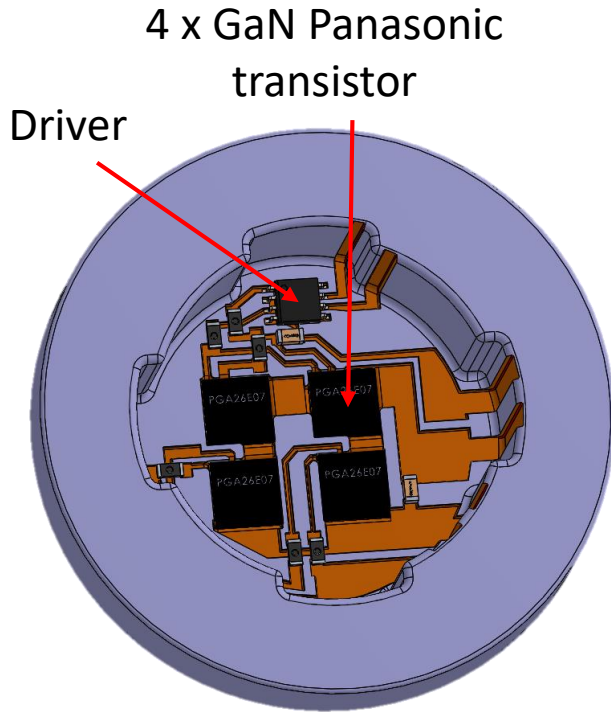

Bottom view

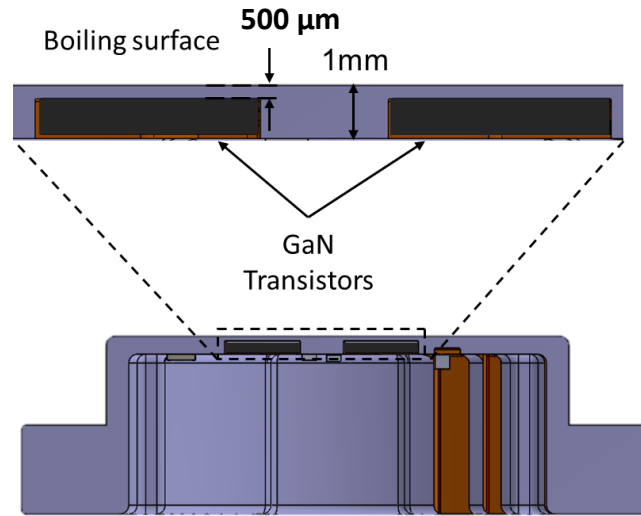

Cross section view

The polymer thermally active area is a planar surface of 1 mm thick and 40 mm in diameter

## Polymer 3D printed evaporator configuration:

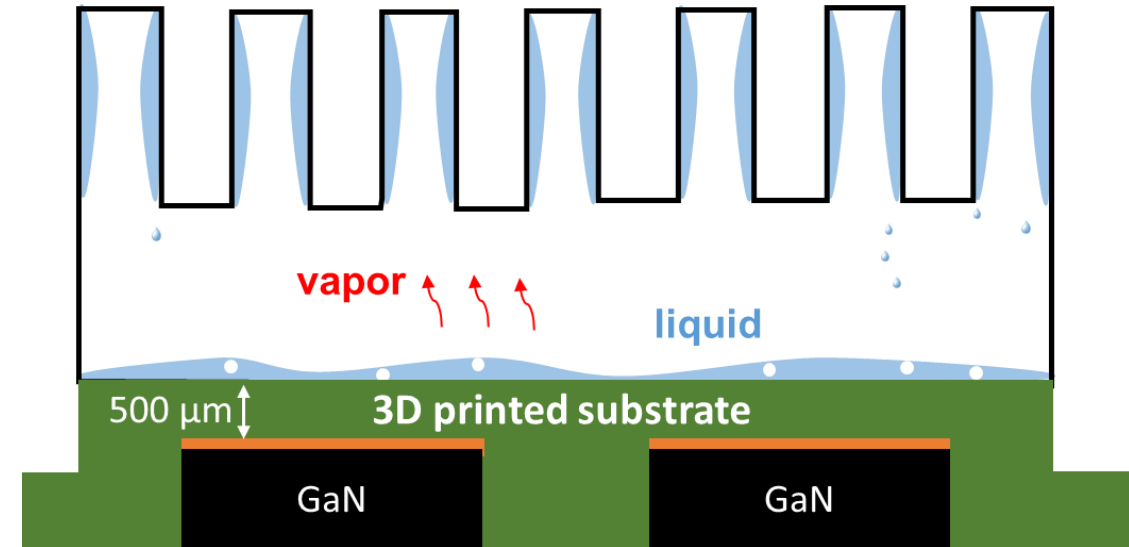

- The PCB is replaced by a 3D printed polymer substrate integrating the electronic components.
- 3D plastronics is used to manufacture the electronic circuit
- Thermal interface is made of polymer (thickness: 500 μm)
- No need for a TIM

# 3. Polymer evaporator: vehicle circuit

## Primary GaN-based circuit:

- Vehicle circuit intended for the thermal analysis
- Dual legs circuit
- The high-side transistors are polarized as dissipating resistors

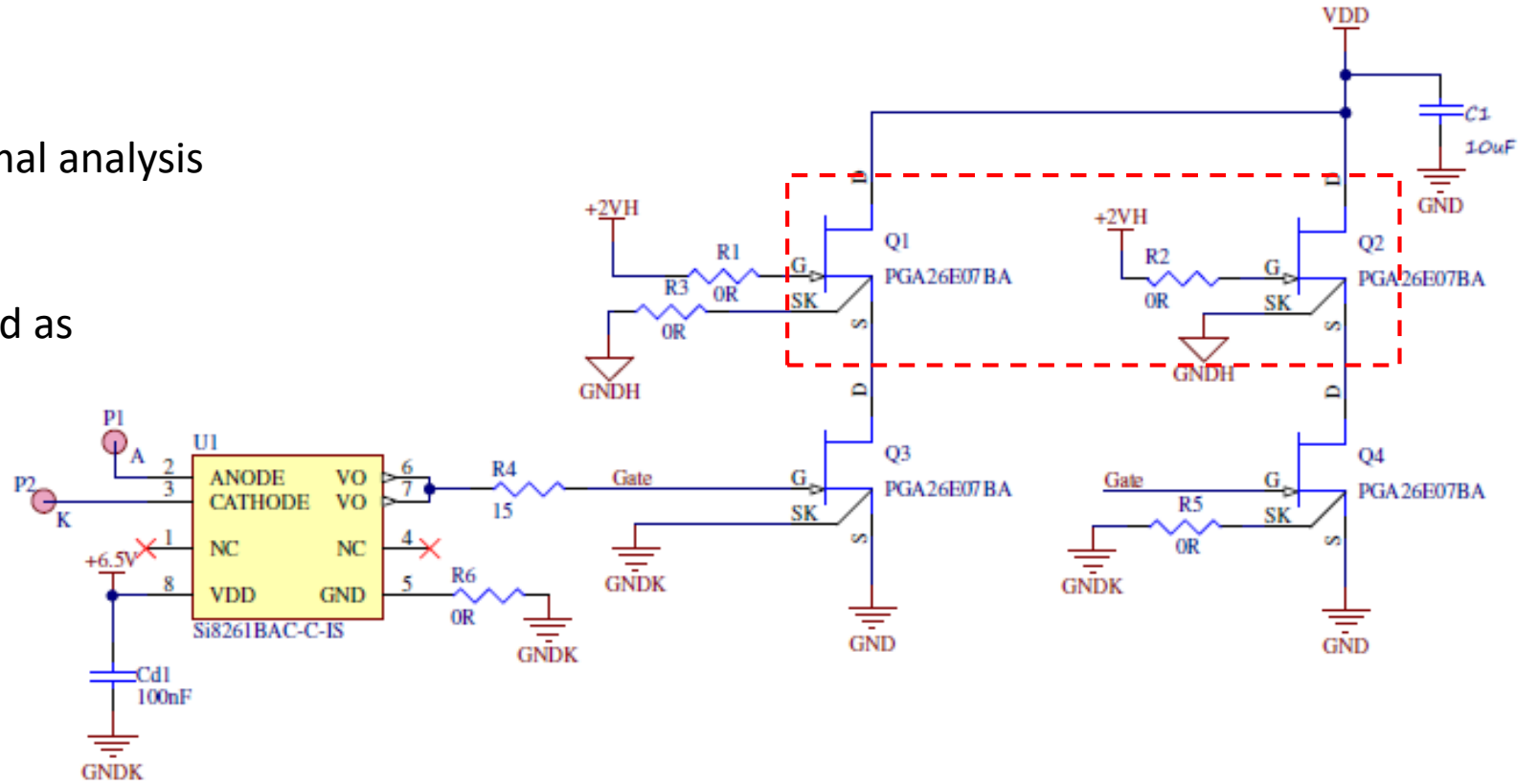

**The circuit is largely sufficient for providing losses with a heat flux up to 10 W/cm<sup>2</sup>**

# 3. Polymer evaporator: Fabrication process

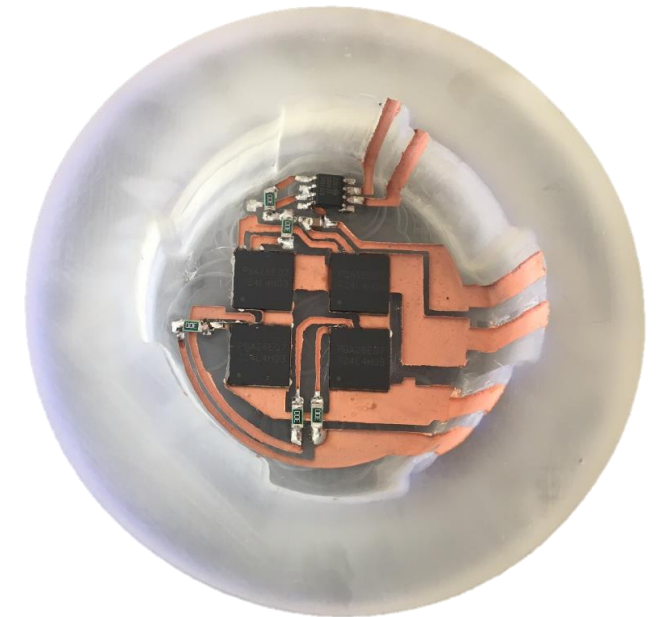
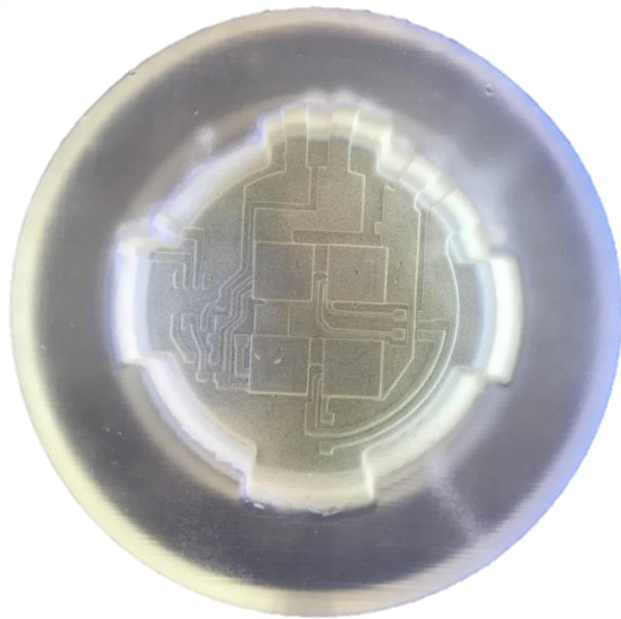

### 3D printed part:

- Stereolithography process
- Form 2 (Formlabs)
- High temperature resin

### Surface treatment:

- Chemical or physical treatment
- To improve metal adhesion



### Copper electroless plating (Rapid 3D-Plastronics process\*)

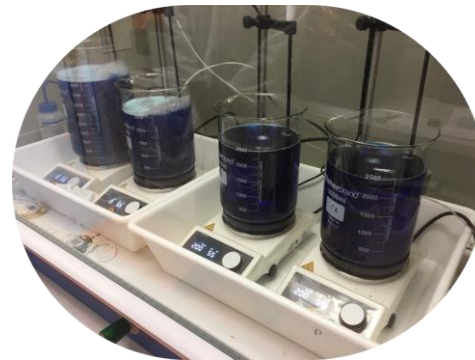

### Soldering the components

➤ **Copper electroplating could be used to enhance copper thickness**

\*T. Gerges et al., Manuscript submitted to Additive Manufacturing 2023, (under revision)

# 3. Polymer evaporator: Characterization & Quality control



(X-ray fluorescence)

**Copper thickness = 7  $\mu\text{m}$**

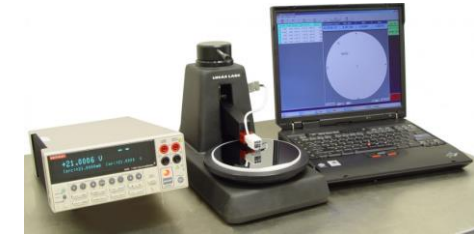

Electrical resistivity  
(4 point probe station)

Standard PCB:  
1.72  $\mu\Omega\cdot\text{cm}$

**Resistivity = 2.2  $\mu\Omega\cdot\text{cm}$**

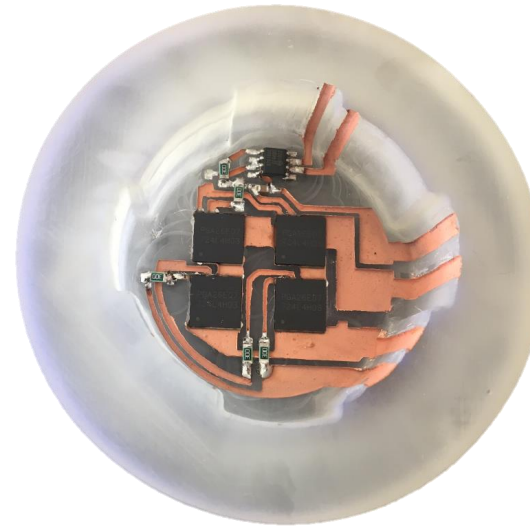

Scotch tape test : ISO 2409

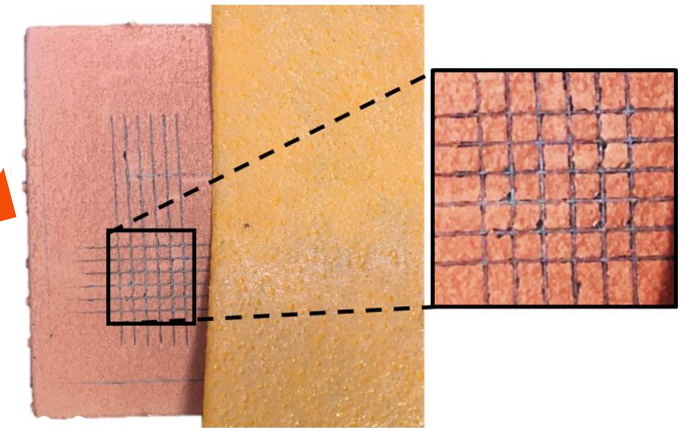

**High copper adhesion**



Numerical microscopy

- Surface morphology inspection
- Roughness measurement

# 3. Polymer evaporator: Thermal characterization

## Developed test bench

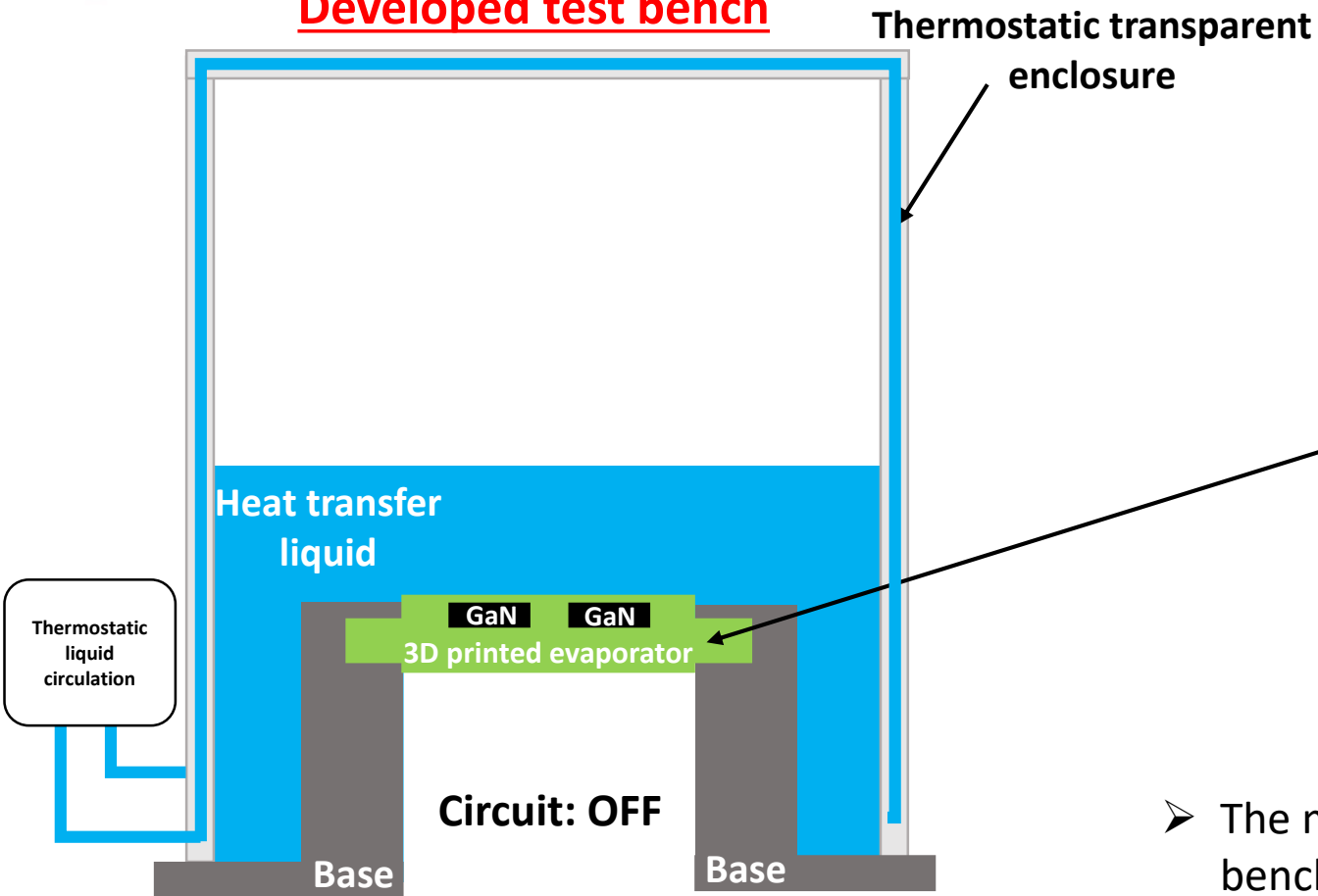

- The manufactured polymer evaporator is mounted in a test bench (with a transparent enclosure)
- Vacuum is applied ( $P < 500 \text{ Pa}$ )
- Partially filled with heat transfer liquid (HFE7000)



# 3. Polymer evaporator: Thermal characterization

## Developed test bench

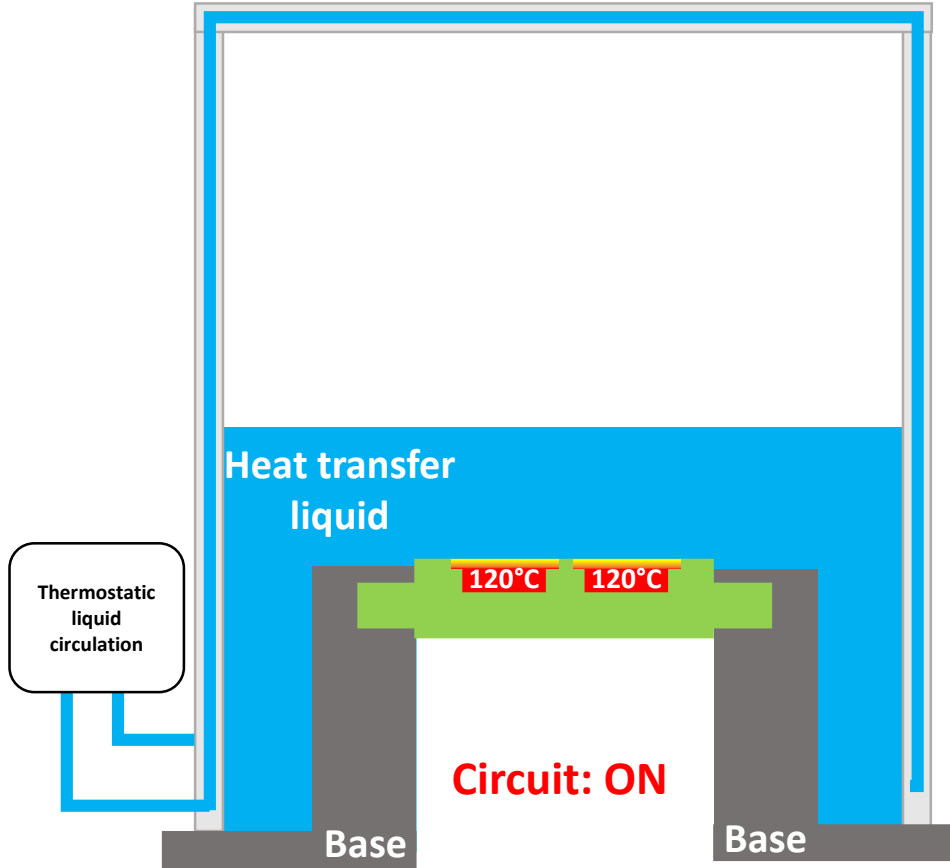

### Apparent heat transfer coefficient:

$$h_{app} = \frac{\Phi_{elec}}{S \times (\bar{T}_{elec} - T_{sat})}$$

$\Phi_{elec}$ : the total heat flux dissipated by the components

$S$ : the total evaporator surface in contact with the dissipative components

$\bar{T}_{elec}$ : the mean value of the 4 components' temperature measurements.

$T_{sat}$ : surrounding fluid area temperature.

### Heat flux density:

$$\varphi_{eff} = \Phi_{elec} / S$$

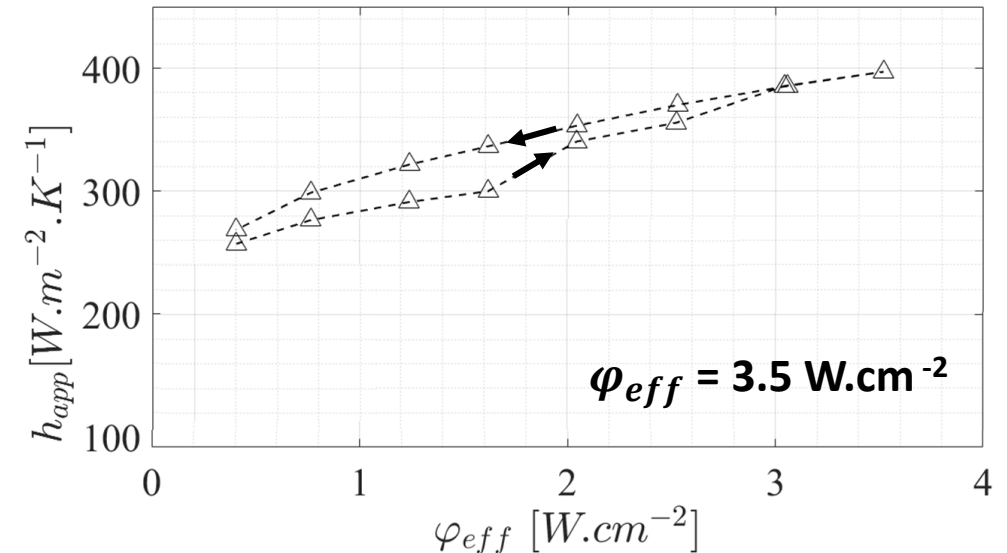

To evaluate the efficiency of the polymer evaporator -> the heat flux applied to the evaporator is increased until the electronic components reached a maximum temperature of 120°C

# 3. Polymer evaporator: Thermal characterization

## Developed test bench

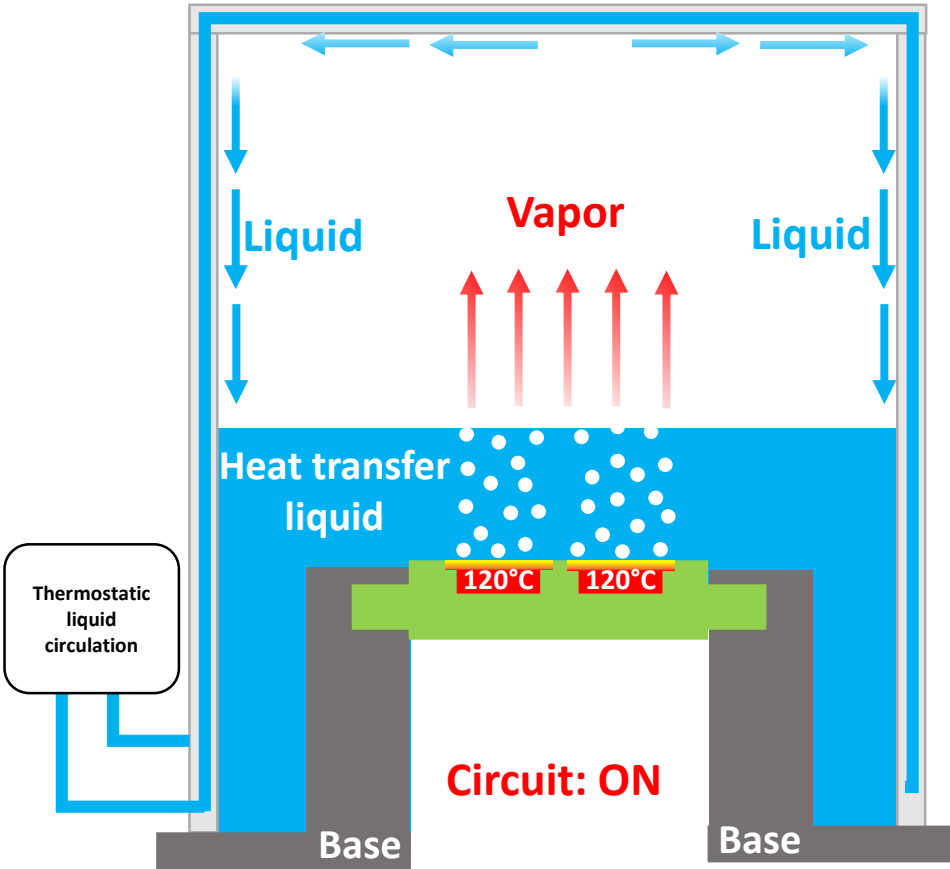

### Heat flux density:

$\varphi_{eff} = 1.6 \text{ W.cm}^{-2}$  → the phase change is initiated

$\varphi_{eff} = 3 \text{ W.cm}^{-2}$  → Boiling is fully developed above each component

$\varphi_{eff} = 3.5 \text{ W.cm}^{-2}$  → Maximum heat flux is achieved

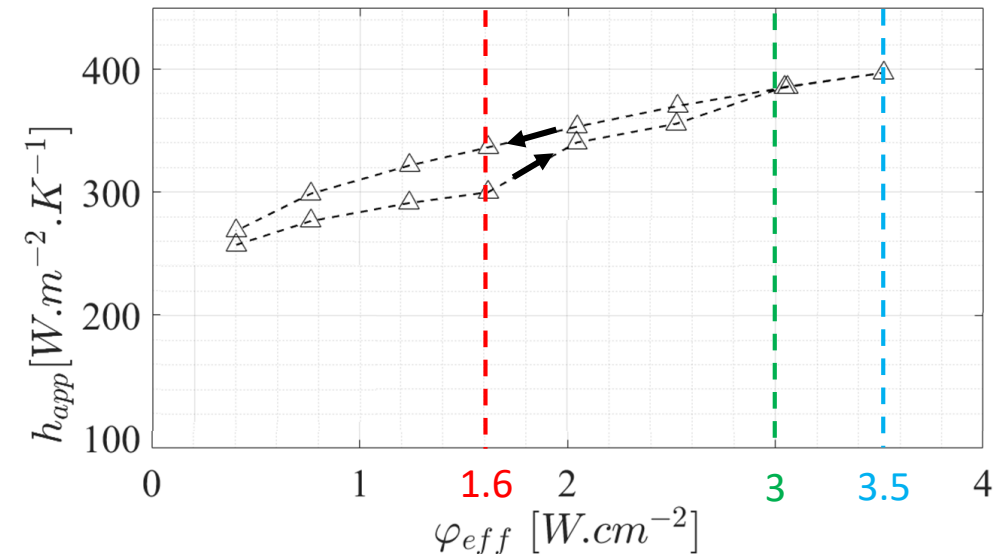

# 3. Polymer evaporator: Thermal characterization

## Developed test bench

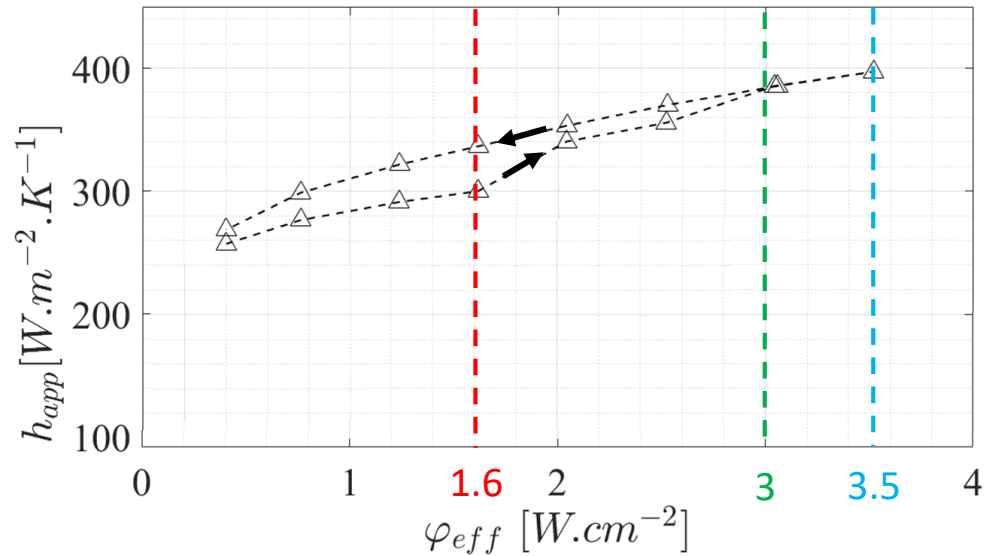
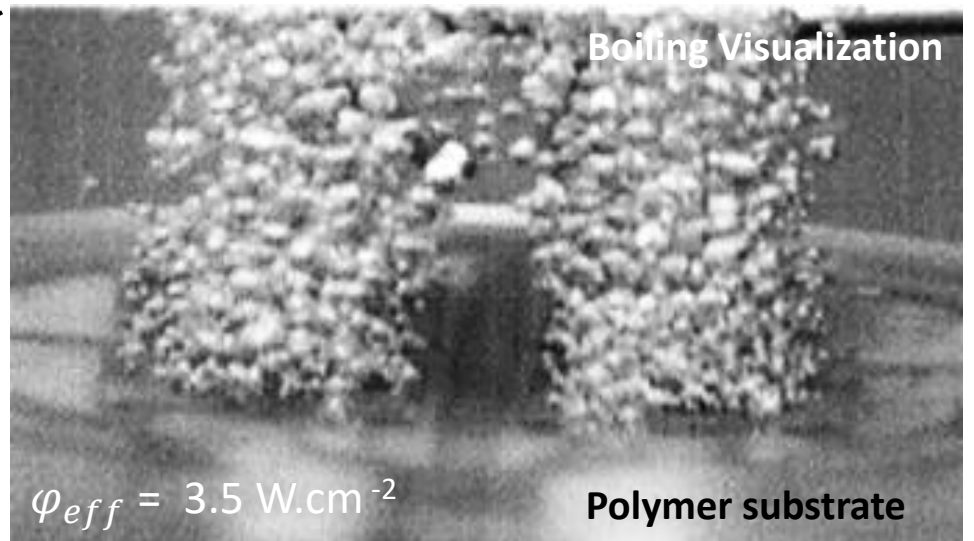
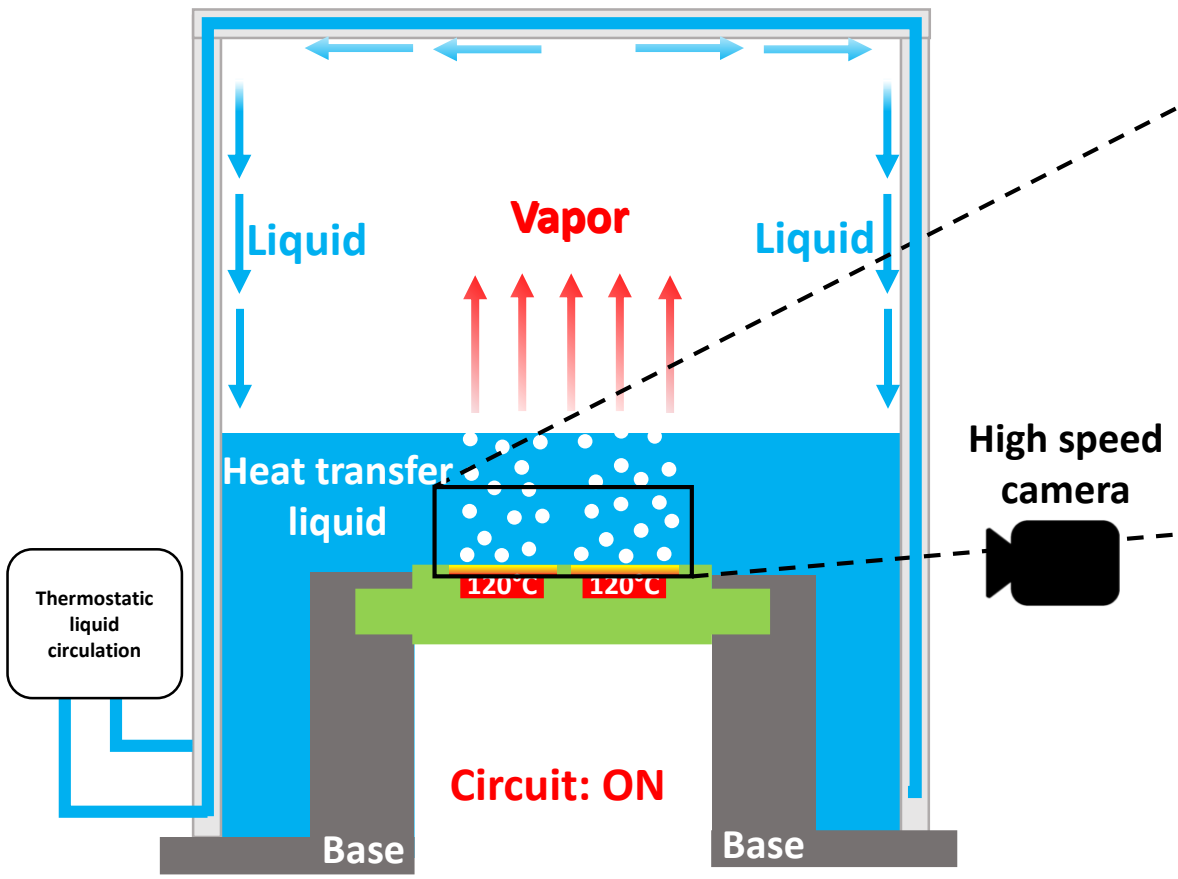

# 3. Polymer evaporator: Improved version with pinholes

The surface morphology effect on the nucleate boiling performance:

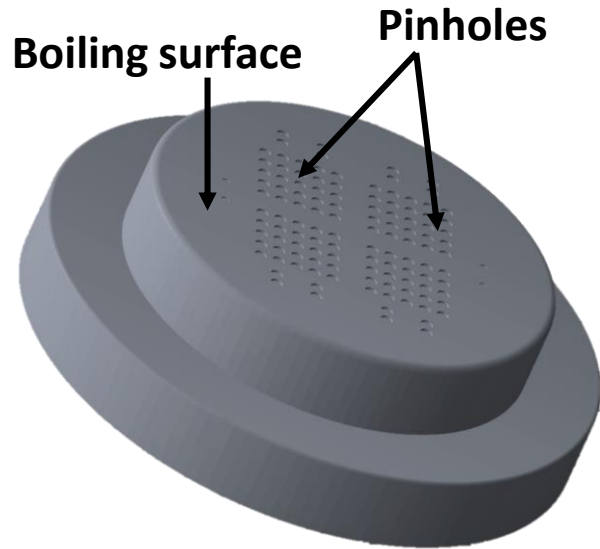

3D printed evaporator with pinholes

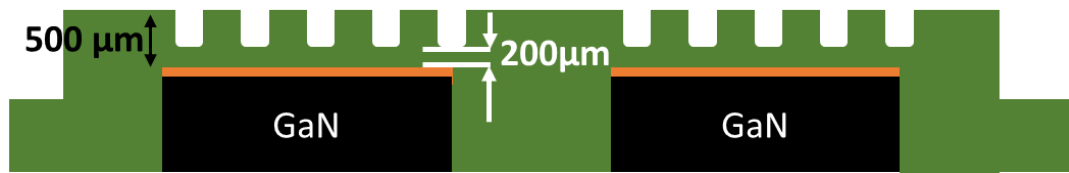

- The pinholes were placed :
  - on the boiling surface side
  - precisely at the location of the 4 components
- Pinholes dimensions: radius of 500 μm, a depth of 300 μm

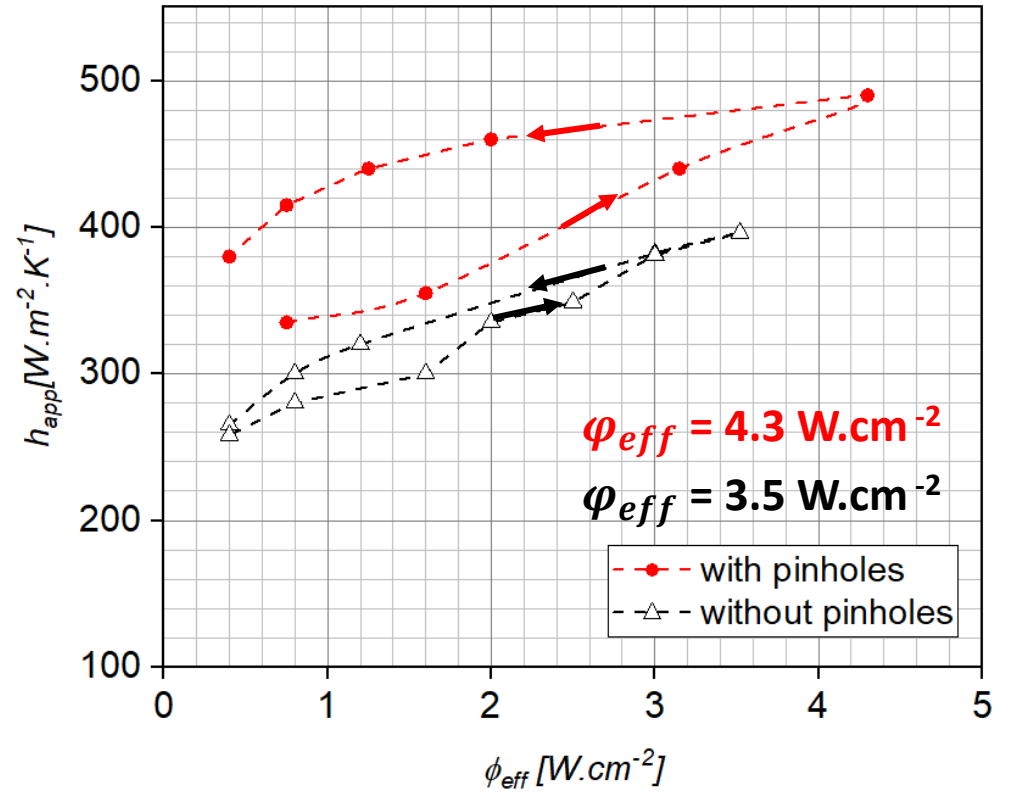

- Pinholes increased the heat transfer by 20%.

The efficiency of this configuration remains limited because of the high thermal resistivity of the polymer

# 4. Hybrid evaporator: Configuration

## Standard configuration

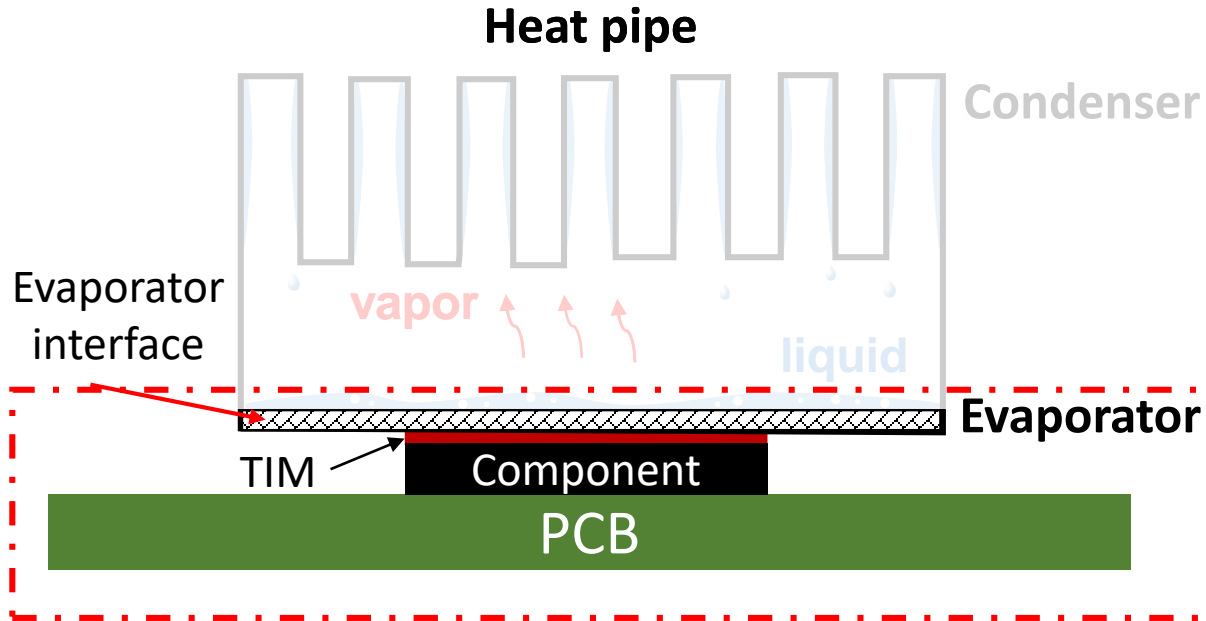

TIM between the metallic evaporator and the component

## Hybrid 3D printed evaporator configuration:

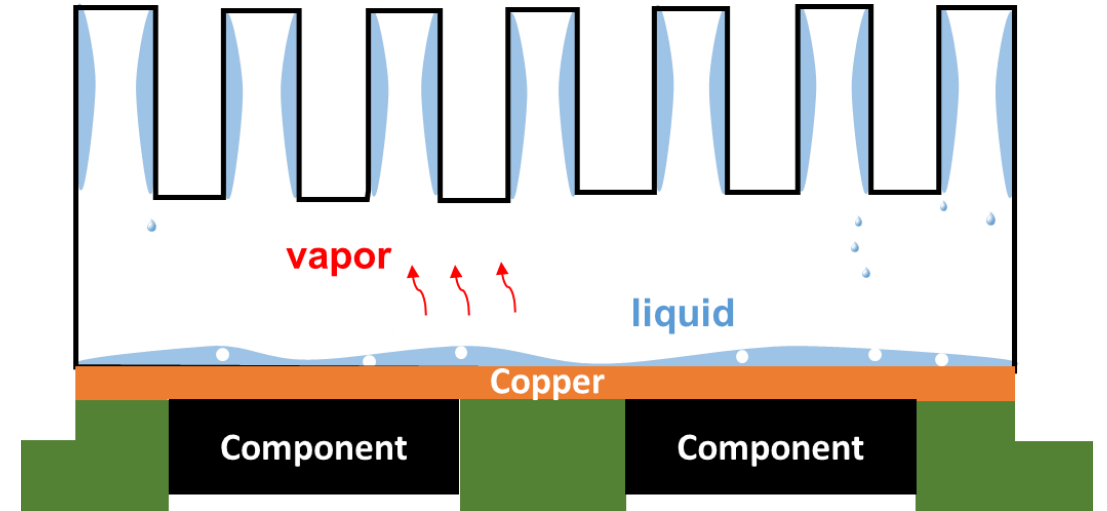

- The PCB is replaced by a 3D printed polymer substrate integrating the electronic components.
- 3D plastronics is used to manufacture the electronic circuit
- Thermal interface is made of copper (thickness: 250  $\mu\text{m}$ )
- No need for a TIM

**This copper interface allows a direct thermal contact between the components and the liquid**

# 4. Hybrid evaporator: 3D design

## Hybrid 3D Evaporator design:

For fabrication and measurement purposes:  
The first prototype was made with small footprint power resistors (PWR263S-35-33R0F)

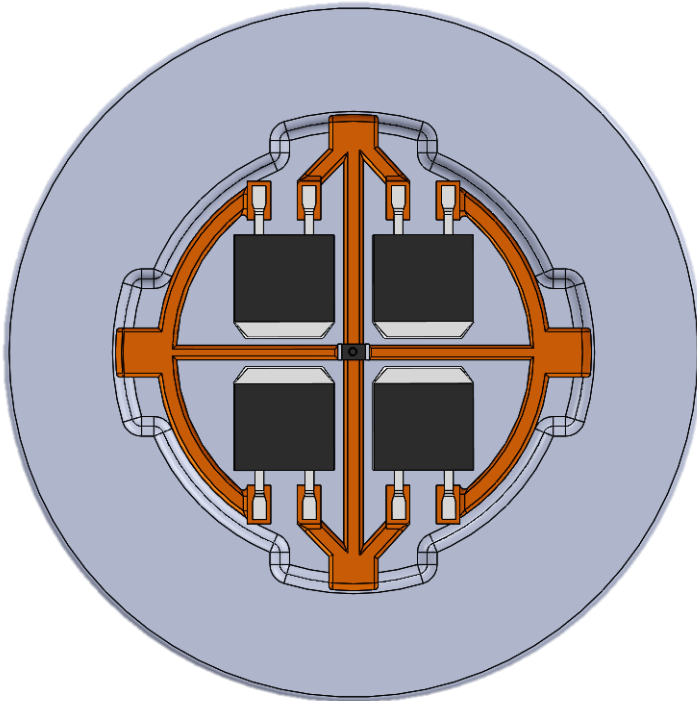

Bottom view

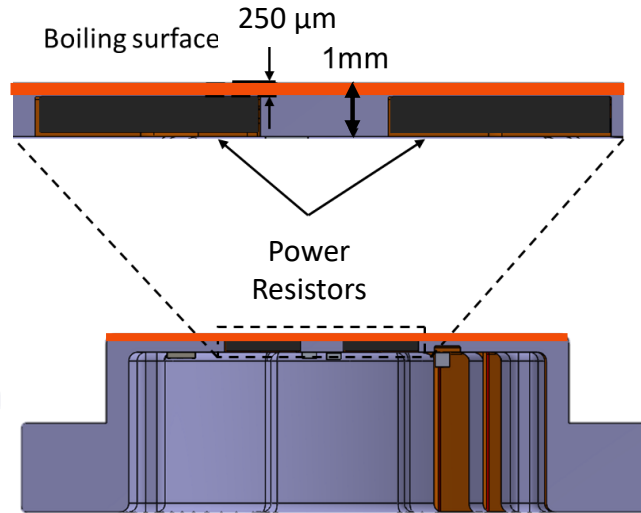

Cross section view

## Hybrid 3D printed evaporator configuration:

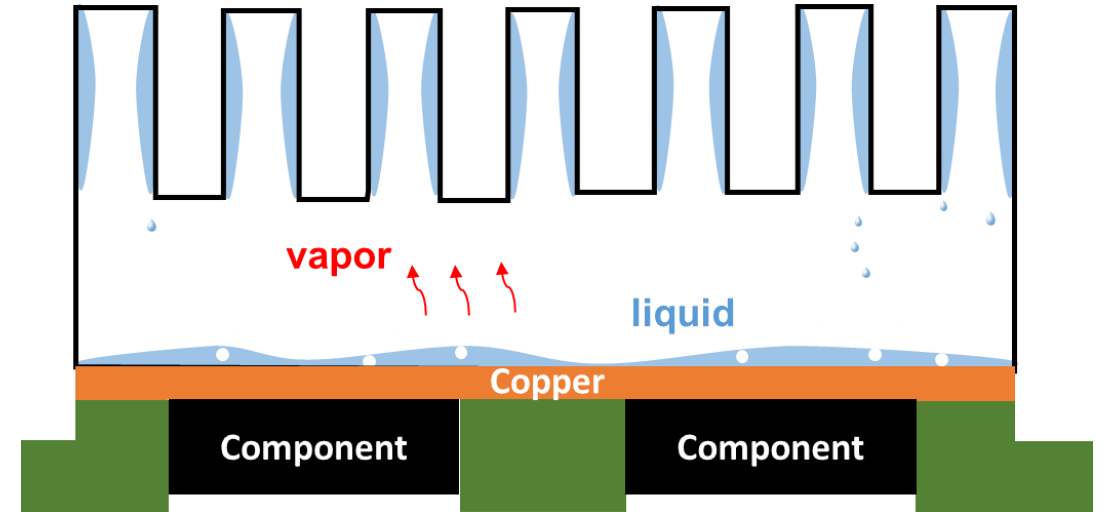

- The PCB is replaced by a 3D printed polymer substrate integrating the electronic components.
- 3D plastronics is used to manufacture the electronic circuit
- Thermal interface is made of copper (thickness: 250  $\mu\text{m}$ )
- No need for a TIM

**This copper interface allows a direct thermal contact between the components and the liquid**

# 4. Hybrid evaporator: Fabrication process

SLA 3D printing

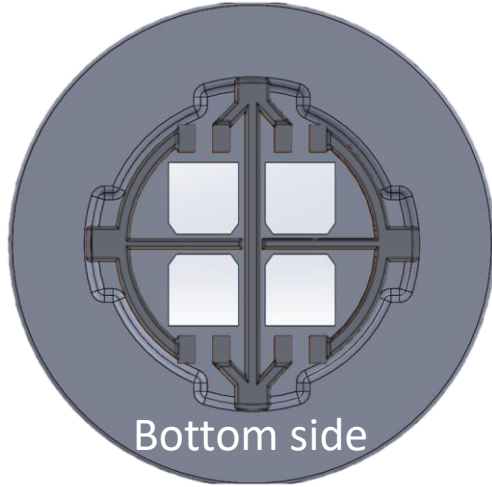

Bottom side

Evaporator designed with holes to integrate the power resistors

Electroless copper plating  
(Rapid 3D-Plastronics process\*)

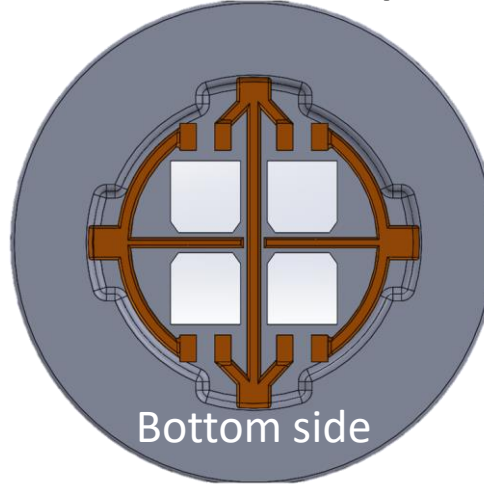

Bottom side

Thermal interface side

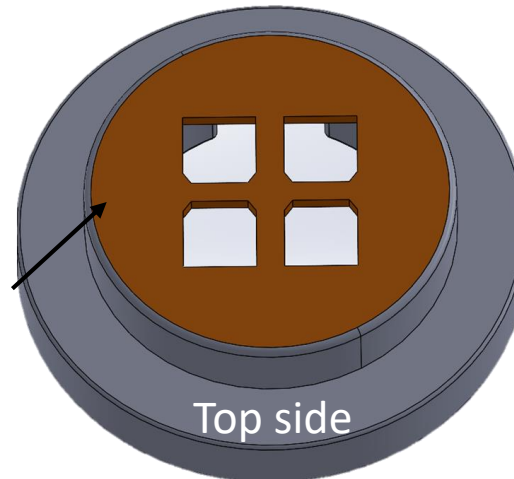

Top side

Components soldering

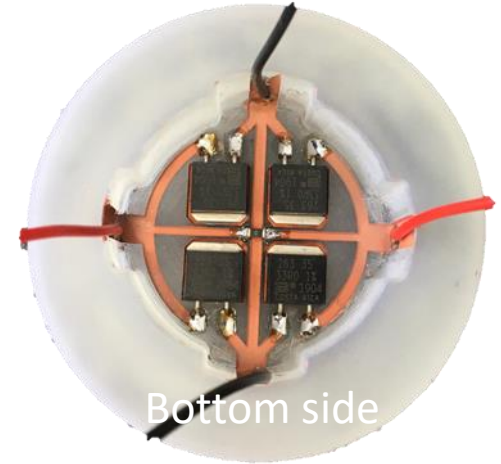

Bottom side

Connect the resistor thermal surface to the evaporator top surface for electroplating

Conductive paste

Resistor thermal pad

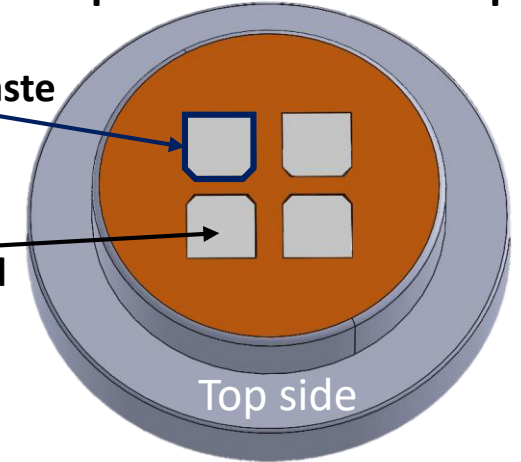

Top side

# 4. Hybrid evaporator: Fabrication process

## Copper electroplating to:

- Cover entirely the thermal interface
- Increase the thermal conductivity



Copper thickness = 250  $\mu\text{m}$

## Thin silver layer deposit:

- To prevent the oxidation of copper during experiments



Silver thickness = 200 nm



# 4. Hybrid evaporator: Thermal characterization

## Developed test bench

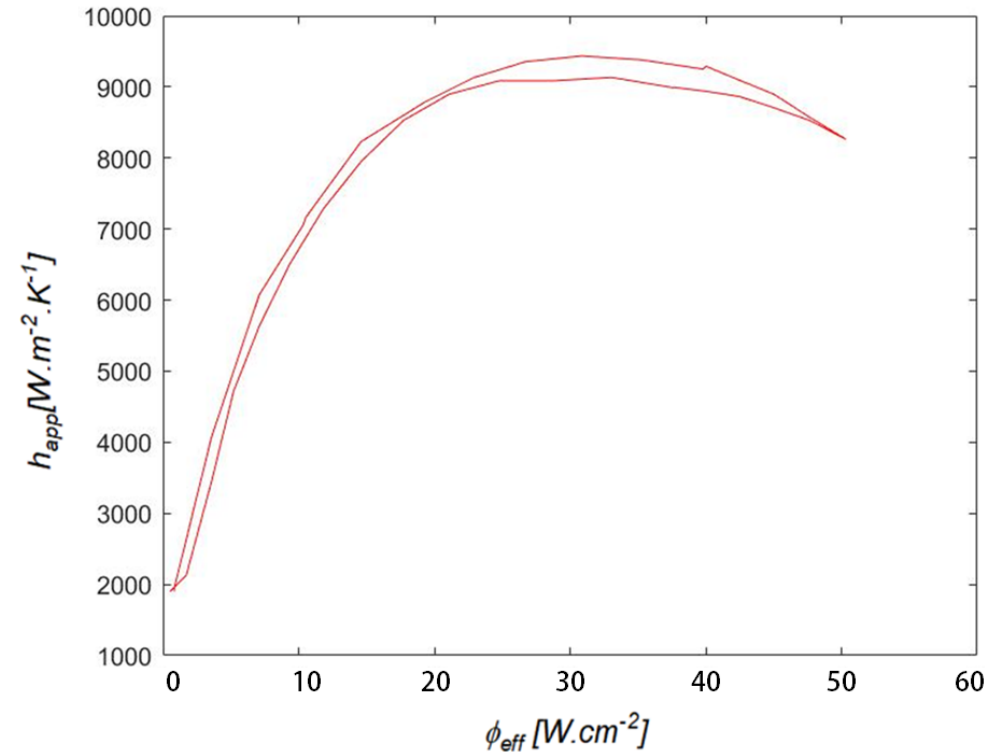
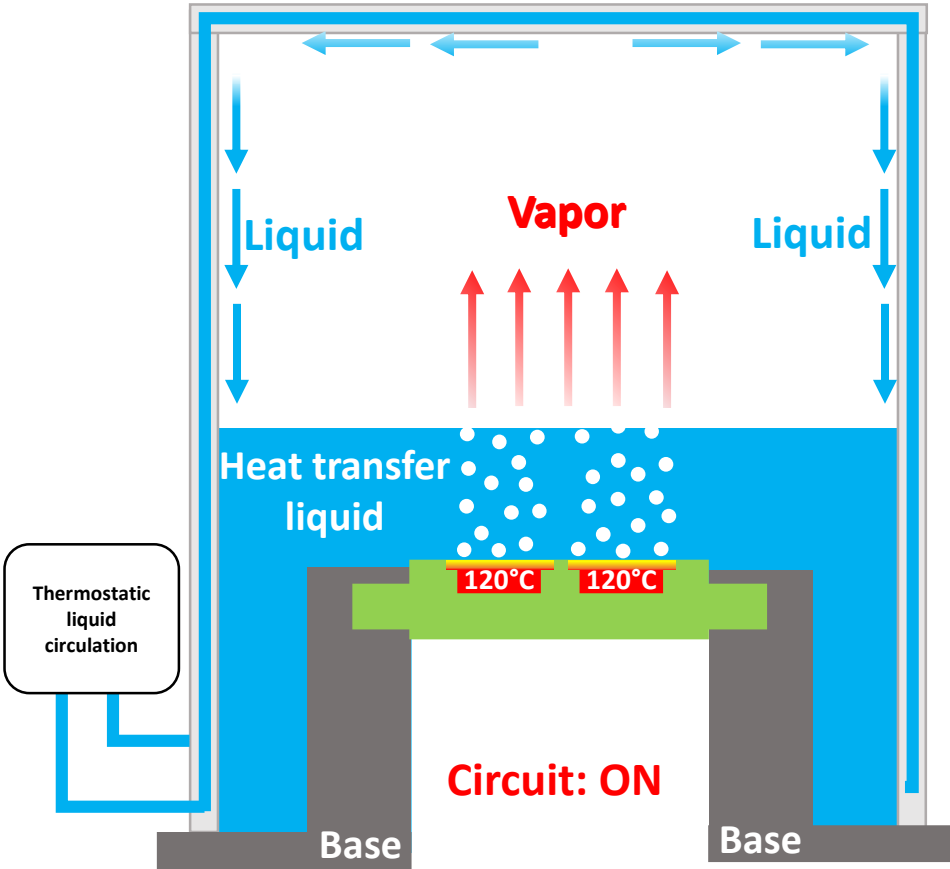

### Preliminary measurements :

- High flux density dissipated  $> 50 W/cm^2$
- Evacuated flux density is 10 times  $>$  polymer evaporator
- Apparent heat coefficient is 20 times  $>$  polymer evaporator

# 5. Conclusion

➤ Two 3D printed polymer-based heat pipe evaporators were manufactured using 3D plastronics and characterized:

➤ Polymer evaporator with polymer for thermal interface



➤ Hybrid evaporator with copper for thermal interface



➤ The use of polymer:

➤ reducing the weight and cost of the assembly.

➤ Chemically compatible with cooling fluids (specially water).

➤ 3D Plastronics technology allows to create directly the copper circuit on the polymer surface.

➤ 3D printed hybrid evaporator shows a high dissipated flux density  $> 50 \text{ W/cm}^2$

## 5. Future Work

---

- Testing the hybrid version with a power electronic circuit using GaN components.
- Designing and manufacturing of a heat pipe with the hybrid evaporator and a polymer condenser
- Developing heat pipes with an industrial manufacturing process such as injection molding for mass production

# Thank you for your attention

*tony.gerges@insa-lyon.fr*

