



**HAL**  
open science

## **Salient features of wheel-vehicle aerodynamic interactions: Consequences for drag**

D. Bao, J. Borée, C. Sicot, C. Roebroek

► **To cite this version:**

D. Bao, J. Borée, C. Sicot, C. Roebroek. Salient features of wheel-vehicle aerodynamic interactions: Consequences for drag. *Journal of Wind Engineering and Industrial Aerodynamics*, 2023, 236, pp.105366. 10.1016/j.jweia.2023.105366 . hal-04028522

**HAL Id: hal-04028522**

**<https://hal.science/hal-04028522>**

Submitted on 14 Mar 2023

**HAL** is a multi-disciplinary open access archive for the deposit and dissemination of scientific research documents, whether they are published or not. The documents may come from teaching and research institutions in France or abroad, or from public or private research centers.

L'archive ouverte pluridisciplinaire **HAL**, est destinée au dépôt et à la diffusion de documents scientifiques de niveau recherche, publiés ou non, émanant des établissements d'enseignement et de recherche français ou étrangers, des laboratoires publics ou privés.

# Salient features of wheel-vehicle aerodynamic interactions: consequences for drag

D. Bao<sup>a\*</sup>, J. Borée<sup>a</sup>, C. Sicot<sup>a</sup>, and C. Roebroek<sup>b</sup>

<sup>a</sup> Institut Pprime, UPR-3346 CNRS – ISAE-ENSMA – Université de Poitiers, Futuroscope Chasseneuil, France.

<sup>b</sup> MFP Michelin, Site de LADOUX, Clermont-Ferrand, France.

## Abstract

Salient features of wheel-vehicle interactions and their consequences for drag are investigated experimentally based on a simplified square-back vehicle with different distances  $l$  between the rear wheels and the base of the vehicle. Two different mechanisms responsible for a base drag increase of up to 12% are distinguished. At the scale of the vehicle, whatever the distance  $l$ , wheels perturb the underflow and induce a global variation of the vertical balance of the vehicle wake. According to the state of the initial wake, significant base drag increase or decrease are observed. Considering the scale of the wheels, if the wheel-to-base distance  $l/w$  ( $w$  being the width of the wheels) is smaller than a threshold of order 3 in the present configuration, the base drag increases and is very sensitive to  $l/w$ . In this situation, a mean mass transfer from the vehicle wake to the wake of the rear wheels is observed. Based on these observations, a physical model is then proposed to explain this high-sensitivity regime.

**Keywords:** automotive aerodynamics, wheels, wake.

## 1. Introduction

Drag reduction of ground vehicles has always been an important topic due to energy and environmental issues. At highway speeds with high energy consumption, the aerodynamic drag accounts for over 50 % of the total drag (Schuetz, 2016). The wheels and their interactions with the main body of the vehicle account for more than 25% of the aerodynamic drag (Wickern *et al.*, 1997). In particular, indirect effects of the wheels leading to an increase in the base drag will have a very detrimental effect on the total drag of the vehicle. The optimization of the wheel drag is often restricted by functionality issues. Therefore, understanding the salient features of wheel-vehicle interactions is of particular importance for drag reduction.

Several aspects of wheel-vehicle interactions were considered in previous studies. Adding fixed or rotating wheels to a vehicle results in an important drag increase (Wickern *et al.*, 1997; Regert & Lajos, 2007; Humnic & Humnic, 2017; Wang, 2019; Pavia, 2019). The flow field was studied and it was found that wheels lead to modifications at the scale of the vehicle, such as a reduction in the underflow momentum and a change in the vertical balance of the vehicle wake.

The effect of wheel rotation was specifically studied by actuating the wheels on a fixed ground or by using moving ground facilities (Cogotti, 1983; Mercker & Knape, 1989; Le Good *et al.*, 1998; Elofsson & Bannister, 2002; Heft *et al.*, 2012; Pavia & Passmore, 2017; Wang *et al.*, 2019, 2020; Rejniak & Gatto, 2021; Yu *et al.*, 2022; Aultman *et al.*, 2022). On a given set-up, comparing fixed and rotating wheel configurations, it was found that rotation is responsible for a moderate drag change (mostly drag decreases). Global changes at the scale of the vehicle were also measured for example in Elofsson & Bannister (2002) and Wang *et al.* (2020). Moreover, changes in the

---

\*Corresponding author. Email address: di.bao@ensma.fr (D.Bao)

38 local interactions between the rear wheel wakes and the vehicle wake were proposed in [Elofsson &](#)  
39 [Bannister \(2002\)](#) and [Wäschle \(2007\)](#) as possible reasons for the changes in drag. However, the  
40 interaction mechanisms at the scale of the rear wheels were not revealed in these two studies.

41 A third aspect concerning geometrical modifications of the wheels was studied for drag reduction.  
42 Some geometrical modifications (for example, the shoulder profile ([Wittmeier et al., 2014](#)), the rim  
43 design ([Landström et al., 2009, 2011](#); [Brandt et al., 2019](#); [Josefsson et al., 2022b](#)), and the tire  
44 pattern ([Hobeika et al., 2013](#); [Hobeika & Sebben, 2018](#); [Reiss et al., 2019](#); [Josefsson et al., 2022a](#)))  
45 were found able to reduce the wheel drag. However, these local changes also induce modifications of  
46 the wheel-vehicle interactions which may compensate for or even dominate the local gains, leading  
47 to an increase in total aerodynamic drag. This can be seen in [Hobeika et al. \(2013\)](#) by applying  
48 different wheel geometries on two types of cars: a sedan and a sports wagon. From a more industrial  
49 point-of-view, [Wittmeier et al. \(2013\)](#) installed different tires having the same dimensions on several  
50 road vehicles. They found that the ranking by the aerodynamic drag of different tires sometimes  
51 depends on vehicle geometry.

52 These previous studies, to some extent, revealed the two main aspects of the wheel-wake inter-  
53 actions. The first one is the global modifications in the underflow and in the equilibrium of the  
54 vehicle wake. The second one is the local interactions between the rear wheels and the vehicle  
55 wake. However, these two aspects, especially the second one, remain to be understood in detail. To  
56 this aim, [Wang \(2019\)](#) proposed that at first order, the wheels can be seen as underflow geometric  
57 perturbations. Model obstacles were then introduced in the underflow of a square-back vehicle and  
58 were found to have the same effects on the flow and on the drag as the wheels. Most importantly, the  
59 key aerodynamic features, the underflow blockage, the development of the wakes of the wheels and  
60 their interactions with the near-wake of the vehicle, are represented. Using this simplified method,  
61 a parametric study was performed in [Bao et al. \(2022\)](#) by perturbing the underflow of a simplified  
62 square-back vehicle using a pair of two-dimensional (2-D) D-shaped obstacles. By systematically  
63 varying the obstacle width and the relative distance from the obstacles to the base of the vehicle,  
64 the sensitivity of the base drag of the vehicle was revealed. Furthermore, a salient feature of the  
65 local near-wake interactions was found to be a mean mass transfer from the wake of the vehicle to  
66 the wakes of the obstacles. This feature was then linked to the base drag changes using a physical  
67 model.

68 In the present work, the wheel-vehicle interactions are investigated experimentally based on a  
69 simplified square-back vehicle with wheels. We focus on the base drag evolution and large-scale  
70 dynamics of the near wake because the base drag is the major drag contributor for this type of  
71 vehicle ([Schuetz, 2016](#)). Our choice is to follow the investigation in [Bao et al. \(2022\)](#), by selecting  
72 the distance between the rear wheels and the base of the vehicle as the main parameter. This is  
73 also based on the fact that a wide range of relative distances can be found for different car types in  
74 the market. Our goal is first to analyze how the wake and drag of the vehicle are globally modified  
75 by the presence of the wheels. The second goal is to reveal in detail what are the salient features of  
76 the local interactions between the rear wheels and the vehicle wake. The experimental apparatus  
77 used for this study are detailed in §2, followed by a description of the baseline flow without the  
78 wheels in §3. By installing the wheels and varying the wheel-to-base distance, the salient features of  
79 wheel-vehicle interactions are revealed in §4. The influence of large-scale asymmetry of the vehicle  
80 wake is then presented in §5. Concluding remarks are proposed in §6.

## 81 **2. Experimental set-up**

### 82 *2.1. Wind tunnel facility and model geometry*

83 The experiments are performed in the S620 closed-loop wind tunnel of ISAE-ENSMA having a 5  
84 m-long test section with a  $2.4 \times 2.6$  m<sup>2</sup> rectangular cross-section. Under most operating conditions,  
85 the turbulence intensity of the incoming flow is of the order of 0.3 % and the spatial inhomogene-  
86 ity is lower than 0.5 %. The arrangement inside the test section and the coordinate system are  
87 schematically given in figure 1(a).

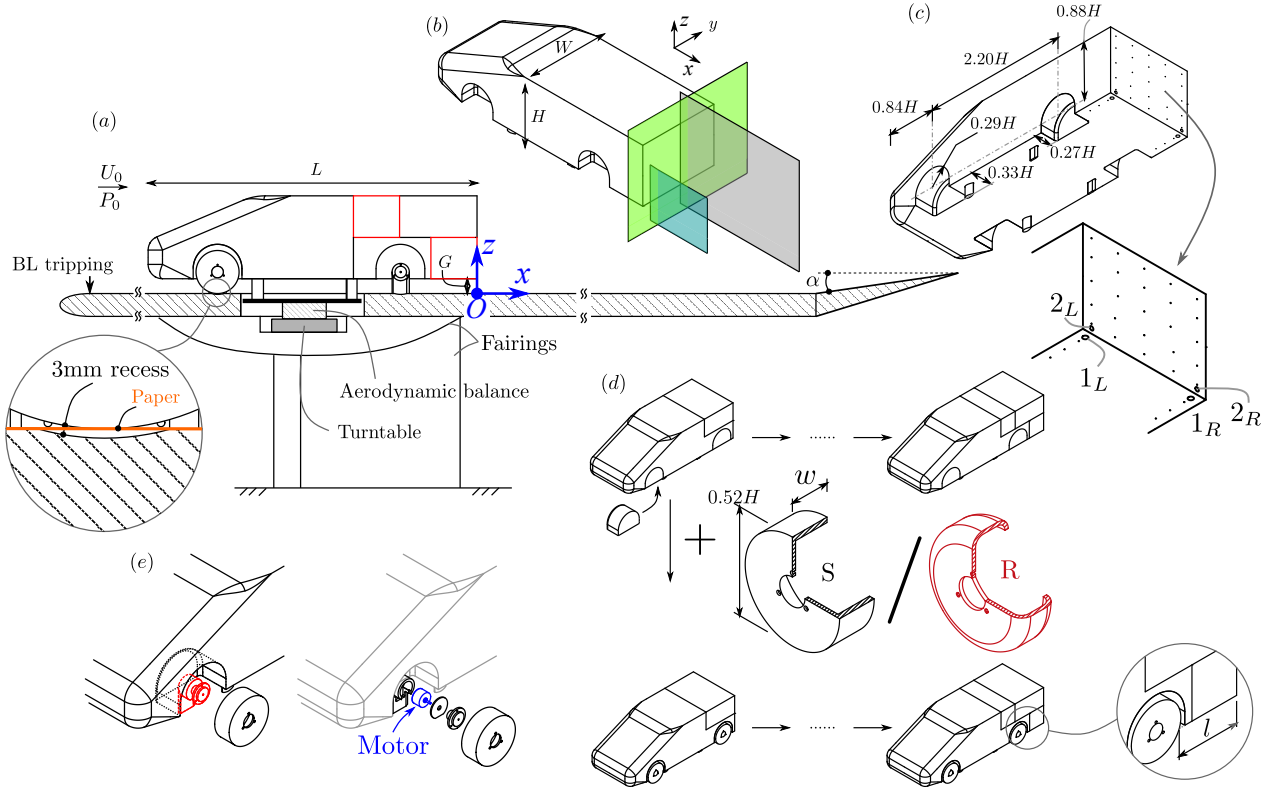

Figure 1: Experimental set-up. (a) Arrangement of the vehicle model and the raised floor in a subsonic wind tunnel. (b) Isometric view of the model and particle image velocimetry (PIV) fields of view (FOVs) in the symmetry plane of the vehicle ( $y/H = 0$ , colored in gray), symmetry plane of the left-hand side wheels ( $y/H = -0.58$ , colored in blue), and cross-flow plane ( $x/H = 0.03$ , colored in green). (c) Dimensions of the wheelhouses and the locations of pressure taps. Points indicate locations of mean pressure measurements and circles indicate locations of time-resolved pressure measurements. (d) Test groups consist of baseline cases and cases with either sharp-edged-shoulder wheels (S) or rounded-shoulder wheels (R). A detailed sketch of how the wheels are installed is given in (e).

88 A square-back simplified vehicle (isometric view in figure 1b), usually referred as the Windsor  
 89 body (Pavia *et al.*, 2020; Varney *et al.*, 2020), is fixed in proximity to a raised floor by four profiled  
 90 struts with a ground clearance  $G = 0.05$  m (around five times the thickness of the incoming boundary  
 91 layer). Four wheelhouses with dimensions and locations detailed in figure 1(c) are equipped on this  
 92 vehicle. The width  $W$  and height  $H$  of the vehicle are 0.389 m and 0.289 m, respectively. Seven  
 93 vehicle lengths  $L/H = \{3.41, 3.49, 3.59, 3.68, 3.78, 3.87, 3.97\}$  are considered by changing the size of  
 94 the plates colored in red in figure 1(a). At the front of the vehicle, all the leading edges are rounded  
 95 with a radius of  $R = 0.05$  m except the edge of the roof, which has a radius of 0.2 m. Before  
 96 installing the vehicle on the floor, the streamwise pressure gradient above the floor is compensated  
 97 by a flap located at the trailing edge of the floor, which is regulated to  $\alpha = 2^\circ$ . The blockage ratio  
 98 above the floor caused by the model is 2.4 %, which makes blockage correction unnecessary.

99 Two types of wheels are used for the present study and are shown in figure 1(d). These wheels  
 100 are of the same diameter  $0.52H$  and width  $w = 0.19H$ . They are machined from solid aluminum  
 101 and have a hollow shape to reduce inertia. Different shoulder radii are considered for the two types  
 102 of wheels. For the wheel type S, the shoulders are sharp edges. On the other hand, for the wheel  
 103 type R, the shoulders are rounded with a radius of  $0.3w$ . This radius is chosen based on the average  
 104 of several tire shoulder radii found in the market (e.g. 205/55R16, 235/55R19).

105 Inside each wheelhouse as shown in figure 1(e), an electrical motor (Maxon EC 45) is fixed on  
 106 the floor through a profiled support and is therefore not in contact with the vehicle. The wheels  
 107 are then installed on the motors. Before the experiments, the location of each wheel is carefully  
 108 adjusted to make the wheel flush to the side of the vehicle, tangent to the floor, and with the axis  
 109 in the symmetry plane of the corresponding wheelhouse. Similar to Pavia (2019) and Varney (2020),

110 a 3 mm deep recess is designed to prevent contact between the wheel and the floor as shown in the  
 111 inserted figure of figure 1(a). However, preliminary tests with stationary wheels showed that the  
 112 resulting gap flow has influence on the base pressure, maximally leading to  $\sim 5\%$  base drag decrease.  
 113 The gap is therefore sealed by placing a kraft paper between each wheel and the floor as shown  
 114 in figure 1(a), producing negligible differences in pressure measurements compared to the situation  
 115 when the recess is fully sealed by high-density foam. During the experiments, The wheels are always  
 116 rotated at the speed of 3187 RPM matching the free-stream velocity. Additional comments and  
 117 analyses on the effects of wheel state (rotating or stationary) are given in appendix A.

118 All the results presented are collected under a free-stream velocity  $U_0 = 25 \text{ m s}^{-1}$ , corresponding  
 119 to a height-based Reynolds number  $Re_H = U_0 H / \nu = 4.8 \times 10^5$ , where  $\nu$  is the kinematic viscosity  
 120 of the air at operating temperature. The same Windsor model equipped with sharp-edged-shoulder  
 121 wheels was tested in Varney (2020). It was found that the model is Reynolds insensitive when  
 122 the test is conducted above the Reynolds number selected for the present study. The origin  $O$   
 123 of the coordinate system  $(x, y, z)$  (shown in figure 1a behind the vehicle) is always located at the  
 124 intersection point of the floor, the rear surface (the base) and the symmetry plane of the vehicle,  
 125 with  $x$ ,  $y$  and  $z$  defined, respectively, along the streamwise, spanwise and floor-normal directions.  
 126 Under this system, the velocity vector is decomposed into  $\mathbf{u} = (u_x, u_y, u_z)$ . Unless otherwise stated,  
 127 all physical quantities are normalized by any appropriate combination of the model height  $H$ , the  
 128 free-stream velocity  $U_0$  and the air density  $\rho$  during the measurements. The Reynolds decomposition  
 129 is employed to decompose a quantity  $\mathcal{X}$  into  $\mathcal{X} = \overline{\mathcal{X}} + \mathcal{X}'$ , where  $\overline{\mathcal{X}}$  and  $\mathcal{X}'$ , respectively, denote its  
 130 time-averaged and fluctuating components.

131 Several factors of the present set-up that may influence the results are now discussed. First  
 132 of all, the floor is fixed and the ground boundary layer reduces the flow momentum under the  
 133 vehicle compared to moving floor condition (Krajnović & Davidson, 2005; Strachan *et al.*, 2007).  
 134 Two different vehicles with stationary wheels, namely a sedan and a square-back, were tested by  
 135 Elofsson & Bannister (2002) to investigate the effect of moving floor. It was found to have a very  
 136 slight effect on the aerodynamic drag. In the present situation where the ground boundary layer is  
 137 taken care of by the raised floor, we expect a slight change in the wake equilibrium of the vehicle.  
 138 An investigation of different wake asymmetries is conducted in section 5. In addition, the contact  
 139 patches between the wheels and the floor are not considered due to the non-deformable shape of  
 140 the model wheels. In Mlinaric & Sebben (2008), the influence of contact patch size on a passenger  
 141 car was investigated. It was concluded that tire deflection has a limited effect on the drag of the  
 142 car and that the flow field is only changed locally near the contact patches of the wheels. A similar  
 143 observation was made in Yu *et al.* (2020). One important hypothesis of this research is that, at  
 144 first order, the wheel wake development is responsible for the local near-wake interactions between  
 145 the rear wheels and the main wake. The results presented in what follows support this hypothesis.  
 146 While an accurate representation of the contact patch - very difficult at a reduced scale (Wäschle,  
 147 2007; Wittmeier *et al.*, 2014) - is needed to obtain quantitative results on a specific car configuration,  
 148 the use of rigid wheels is justified to focus on the main physical contributions, which is the goal of  
 149 the present work.

## 150 2.2. Test groups

$L/H$	3.41	3.49	3.59	3.68	3.78	3.87	3.97
Baseline group	×	×	×	×	×	×	×
Wheel group S	×	×	×	×	×	×	×
Wheel group R	×	-	-	-	-	-	×

Table 1: Cases considered for each test group.

151 The cases tested are categorized into different groups and are summarized in table 1. First, four  
 152 plugs are used to fill the wheelhouses as shown in figure 1(d). The seven different lengths are tested

153 in this situation which forms the baseline group. For the wheel group S (sharp-edged shoulder), the  
 154 seven different lengths are tested. On the other hand, for the wheel group R (rounded shoulder),  
 155 only the shortest and the longest vehicle lengths are tested. The distance  $l$  from the rear wheels to  
 156 the base (see figure 1d) is varied thanks to the variation in the vehicle length, which gives  $l/w =$   
 157  $\{0.65, 1.08, 1.58, 2.08, 2.58, 3.08, 3.58\}$ . The  $l/w$  range considered here includes the  $l/w$  values for  
 158 typical road square-back vehicles, from mini vehicles for example Smart Fortwo W453 ( $l/w = 0.52$ )  
 159 to big Multi-Purpose Vehicles (MPVs) for example Mercedes-Benz V-class W447 ( $l/w = 3.46$ ).

### 160 2.3. Pressure measurements

161 Two different pressure measurement systems are used to perform surface pressure measurements.  
 162 The first one used for time-averaged and long-timescale measurements includes two 64-channel ESP-  
 163 DTC pressure scanners linked to 1 mm diameter pressure taps located around the model by 78 cm  
 164 long vinyl tubes. 25 taps on the base and 6 taps on the underside (see figure 1c) are used in the  
 165 present work. The taps on the base and on the underside are connected, respectively, to the two  
 166 scanners with ranges of  $\pm 1$  and  $\pm 2.5$  kPa. The accuracy of the two scanners lies respectively below  
 167  $\pm 1.5$  and  $\pm 3.75$  Pa. Acquisitions from the scanners are conducted at a sampling rate of 100 Hz.

168 The second system dedicated to time-resolved measurements contains four differential pressure  
 169 sensors (SensorTechnics HCLA 02X5DB) connected to the pressure taps located on the base and  
 170 the underside using 64 cm tubes. These taps are numbered as  $n_{L,R}$  ( $n \in [1, 2]$ ) as shown in figure  
 171 1(c), where  $L$  and  $R$  denote the left-hand and right-hand sides, respectively. The measurements  
 172 are a posteriori calibrated and corrected to compensate for the pressure distortions induced by the  
 173 tubings so that the frequency response of the system is flat on the whole frequency range considered  
 174 in the present study. A sampling frequency of 2000 Hz is used for this system with an accuracy of  
 175  $\pm 0.7$  Pa.

176 The pressure coefficient  $C_p$  is used to express the pressure measurements and is defined as:

$$C_p = \frac{p - p_0}{0.5\rho U_0^2}, \quad (1)$$

177 where the reference static pressure  $p_0$  is always obtained at  $2.4H$  downstream the front of the  
 178 vehicle from a Pitot tube installed at the ceiling of the test section. For all the cases gathered, the  
 179 duration of the pressure measurements is 300 s. For the baseline case presenting lateral bimodal  
 180 behavior on a long-timescale of the order of  $O(10^3 H/U_0)$  (Grandemange *et al.*, 2013), this measure-  
 181 ment duration is not sufficient to obtain complete statistical convergence. Nevertheless, this time  
 182 window is chosen as a compromise between a reasonable duration of the experimental campaign  
 183 and a satisfactory convergence of the mean base pressure. For a baseline case having a horizon-  
 184 tal bi-stable wake, the standard deviation of mean base pressure values obtained from repeated  
 185 measurements is found to be less than 1% of the average value.

186 Using the 25 pressure measurements on the base, a function of  $C_p$  is generated for the whole  
 187 surface in order to calculate the pressure drag from the base:

$$C_B = \frac{-\int_B C_p ds}{HW}, \quad (2)$$

188 where  $B$  represents the base surface. The asymmetry of the vehicle wake is characterized by the  
 189 position of the base center of pressure (CoP) ( $y_b, z_b$ ) relative to the center of the base of coordinates  
 190  $(0, 0, G + H/2)$ . The two components of the CoP are calculated via:

$$y_b = \frac{\sum_{i=1}^{25} y_i C_p(y_i, z_i, t)}{\sum_{i=1}^{25} C_p(y_i, z_i, t)}, z_b = \frac{\sum_{i=1}^{25} (z_i - G - H/2) C_p(y_i, z_i, t)}{\sum_{i=1}^{25} C_p(y_i, z_i, t)}. \quad (3)$$

191 In the same fashion as Varney (2020), the mean horizontal component of the base CoP  $\overline{y_b/H}$  is  
 192 used to achieve the zero yaw condition based on a pressure measurement of 10 minutes (i.e.  $5 \times 10^4$   
 193 convective time units  $H/U_0$ ). The turntable as shown in figure 1(a) is used to yaw the baseline



Planes	set-up	$x/H$ range	$y/H$ range	$z/H$ range	Vector spacing
vehicle symmetry plane	2D2C	[0, 2.7]	-	[0, 1.6]	0.0045H
wheel symmetry plane	2D2C	[0, 1.0]	-	[0,0.9]	0.0023H
Cross-flow plane	2D3C	-	[-1.4,1.4]	[0,1.3]	0.0034H

Table 2: Details of PIV fields of view.

194 vehicle with an increment of  $0.1^\circ$ . The mechanical yaw angle with the minimum  $|\overline{y_b/H}|$  is found to  
195 be  $0.1^\circ$  and is chosen as the zero yaw condition.

196 For detailed investigations of pressure measurements, we define  $\langle C_p \rangle$  as the spatial-averaged  
197 pressure coefficient from the left-hand  $L$  and right-hand  $R$  sides of the vehicle in order to reduce  
198 the influence of any residual asymmetry of the vehicle wake:

$$\langle C_p \rangle = \frac{1}{2}(C_p(y_i, z_i, t) + C_p(-y_i, z_i, t)). \quad (4)$$

199 For the spectral information obtained from the differential pressure sensors, the same space-  
200 averaging is also applied for the spectra.

#### 201 2.4. Aerodynamic force measurements

202 A six-component aerodynamic balance (9129AA Kistler piezoelectric sensors and 5080A charge  
203 amplifier) connected to the model is used to quantify the aerodynamic drag acting on the model.  
204 Measurements are performed at a sample rate of 200 Hz with a total accuracy below 0.6 % of the  
205 full range, representing 1 % in the mean drag force  $\overline{F_x}$ . A low-pass filter at 10 Hz is applied directly  
206 to the charge amplifier to limit high-frequency noise. The drag coefficient is defined as:

$$C_D = \frac{F_x}{0.5\rho U_0^2 HW}. \quad (5)$$

207 The force measurements are always performed simultaneously with the pressure measurements  
208 with the same sampling duration. Therefore, the same conclusion regarding statistical convergence  
209 is achieved.

#### 210 2.5. Velocity measurements

211 The velocity fields in the near wake are measured by a particle image velocimetry (PIV) system.  
212 The system consists of a Quantel EverGreen  $2 \times 200$ mJ laser and two LaVision Imager LX 16  
213 Mpx cameras. The seeding of the flow is introduced downstream of the raised floor and recirculates  
214 through the tunnel closed circuit. Particles with diameter of  $1 \mu\text{m}$  are generated by atomization of  
215 mineral oil. Three two-dimensional fields of view (FOVs) are considered as depicted in figure 1(d).  
216 The first one located in the cross-flow plane ( $x/H = 0.03$ ) in proximity to the base of the vehicle is of  
217 stereoscopic (2-D three-component (2D3C)) set-up, capturing three velocity components. The other  
218 two FOVs respectively located in the symmetry planes of the vehicle ( $y/H = 0$ ) and of the left-hand  
219 rear wheel ( $y/H = -0.58$ ) are of 2-D two-component (2D2C) set-up, obtaining the streamwise  $u_x$   
220 and vertical  $u_z$  velocity components. The details of the PIV FOVs are given in table 2.

221 For representative cases, 1200 pairs of images are captured from each FOV at a sample rate  
222 of 4 Hz, which is satisfactory for statistical convergence of first- and second-order statistics. The  
223 image pairs are processed using DaVis 10.1 with a final interrogation window of  $16 \times 16$  pixels  
224 for all FOVs. All the processing is performed with an overlap of 50 %. The resulting vector  
225 spacing for each measurement plane is summarized in table 2. The maximum uncertainty on the  
226 instantaneous velocity fields from different FOVs considering an absolute displacement error of 0.1  
227 pixels is estimated to be less than  $0.01U_0$ .

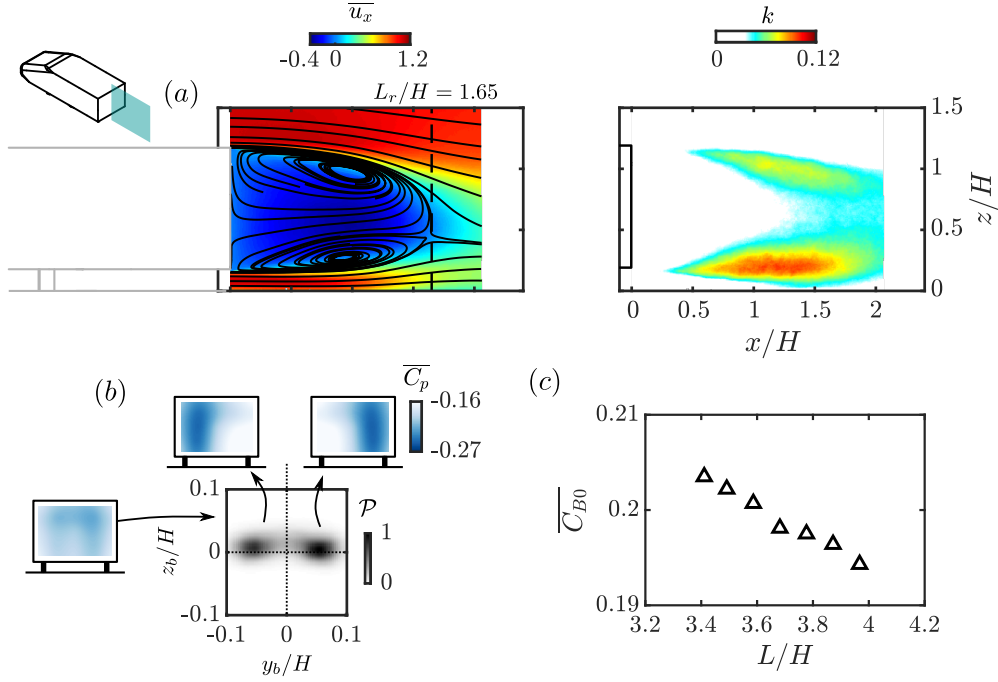

Figure 2: Baseline flow for the longest vehicle  $L/H = 3.97$ . (a) Mean streamwise velocity  $\overline{u_x}$  and turbulent kinetic energy  $k = (\overline{u'_x u'_x} + \overline{u'_z u'_z})/2$  in the symmetry plane of the vehicle  $y/H = 0$ . (b) Conditional averaging of the base pressure distribution based on the joint probability density function (p.d.f.) of the base CoP position. (c) Evolution of the base drag  $\overline{C_{B0}}$  with the length of the vehicle  $L/H$ .

### 228 3. Baseline flow

229 Before installing the wheels on the vehicle model, we briefly characterize the baseline cases. To this  
 230 end, the wake flow for the longest baseline vehicle  $L/H = 3.97$  is presented in figure 2.

231 The mean streamlines in the symmetry plane of the vehicle ( $y/H = 0$ ) describe a wake with  
 232 vanishing vertical asymmetry. The length of the recirculation region is quantified by:

$$L_r = \max(x)_{\overline{u_x} \leq 0}. \quad (6)$$

233 The global topology is qualitatively similar to the wake captured in Pavia *et al.* (2020) using  
 234 also a Windsor body (their vehicle length is shorter). As detailed in Haffner *et al.* (2020), a weak  
 235 interaction between the top and bottom shear layers is observed for this type of wake. Depicting the  
 236 mean turbulent kinetic energy  $k = (\overline{u'_x u'_x} + \overline{u'_z u'_z})/2$ , almost balanced turbulent levels are noticed  
 237 between the top and bottom shear layers. Therefore, with the underflow perturbed later by the  
 238 wheels, a change in the vertical wake balance may lead to a drag increase as shown in Bao *et al.*  
 239 (2022), Perry & Passmore (2013) and Haffner *et al.* (2021).

240 In the horizontal direction, the wake exhibits the well-known long-time random switching motion  
 241 (Grandemange *et al.*, 2013) with two equiprobable states as presented in figure 2(b). The two states  
 242 are given by the joint probability density function (p.d.f.) of the two components of the base CoP  
 243 position. Further conditional averaging based on the sign of the horizontal component of the base  
 244 CoP position  $y_b/H$  provides the base pressure distributions of the two wake states shown in figure  
 245 2(b), which represent wake topologies dominated by a large recirculating flow at the left-hand and  
 246 right-hand sides, respectively.

247 The evolution of base drag and total drag coefficients with the length of the vehicle is displayed  
 248 in table 3. From the case  $L/H = 3.97$  described before, there is a continuous increase of base drag  
 249 with reducing  $L/H$  (also plotted in figure 2c), while the total drag is approximately constant. The  
 250 difference between the two variations can be attributed to the reduction in the friction drag with  
 251 decreasing model length. The measurements show that the wake characteristics shown in figure 2(a)  
 252 remain the same for all the lengths (only the recirculation length  $L_r$  is shown in table 3 for brevity).



$L/H$	3.41	3.49	3.59	3.68	3.78	3.87	3.97
$\overline{C_{B0}}$	0.204	0.202	0.201	0.198	0.198	0.196	0.194
$\overline{C_{D0}}$	0.225	0.226	0.226	0.226	0.226	0.225	0.225
$L_r/H$	1.66	1.66	1.66	1.66	1.65	1.64	1.65

Table 3: Evolution of the mean aerodynamic characteristics with the model length  $L$ .

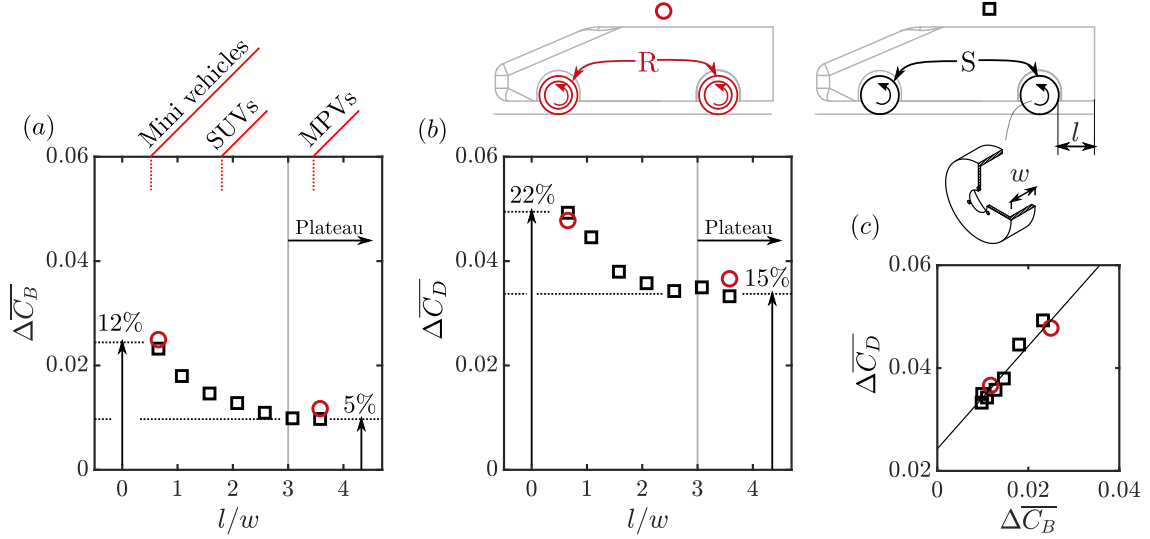

Figure 3: Evolution of (a) the base drag  $\Delta \overline{C_B} = \overline{C_B} - \overline{C_{B0}}$  and (b) total drag  $\Delta \overline{C_D} = \overline{C_D} - \overline{C_{D0}}$  of the body as a function of the wheel-to-base distance  $l/w$ . Both sharp-edged-shoulder wheels (S, colored in black) and rounded-shoulder wheels (R, colored in red) are considered. The relationship between  $\Delta \overline{C_D}$  and  $\Delta \overline{C_B}$  is shown in (c).

253 Preliminary Reynolds-Averaged Navier-Stokes (RANS) computations not shown here for brevity  
254 show that this base drag decrease with increasing vehicle length is a potential flow effect. Indeed,  
255 downstream the flow acceleration along the front part of the model and outside the boundary layer,  
256 in the potential flow region, the velocity at separation from the base decreases with vehicle length.  
257 This results in the observed pressure recovery. In what follows, when the wheels are installed, the  
258 base drag and total drag are always expressed relative to the corresponding baseline case with the  
259 same length in order to focus on the role of the wheels.

## 260 4. Salient features of wheel-vehicle interactions

### 261 4.1. Drag sensitivity to wheel-to-base distance

262 The global impact of the wheels on the baseline wake is now investigated. In figure 3(a) and (b),  
263 the base drag  $\Delta \overline{C_B} = \overline{C_B} - \overline{C_{B0}}$  and total drag  $\Delta \overline{C_D} = \overline{C_D} - \overline{C_{D0}}$  relative to the baseline cases  
264 are shown respectively. For each case having a base drag value of  $\overline{C_B}$  and a total drag value of  
265  $\overline{C_D}$ ,  $\overline{C_{B0}}$  and  $\overline{C_{D0}}$  represent the values of the corresponding baseline case with the same vehicle  
266 length. A detailed measurement spanning all the possible wheel-to-base distances is conducted for  
267 the configuration using the sharp-edged-shoulder wheels S, while only the minimum and maximum  
268  $l/w$  values are tested for the rounded-shoulder configuration R.

269 We focus first on the base drag variation in figure 3(a) for the configuration S. For the longest  
270 baseline case providing the maximum wheel-to-base distance  $\max(l/w)=3.58$ , the wheels are found  
271 to increase the base drag by  $\sim 5\%$  ( $\Delta \overline{C_B}/\overline{C_{B0}} \approx 5\%$ ). With decreasing  $l/w$ , we remark that the base  
272 drag increase is very similar for  $l/w = 3.58$  and  $l/w = 3.08$ . It is noted here that relative distances  
273 larger than  $l/w = 3.58$  were not considered for the present study. However, by modeling the wheels  
274 as D-shaped obstacles, larger "wheel-to-base" distances were considered in Bao *et al.* (2022). A  
275 clear plateau having weak base drag sensitivity to the wheel-to-base distance was identified. In

276 what follows, we will therefore consider that a plateau is reached for  $l/w > 3$ . This will be further  
 277 confirmed in section 5 by changing the initial wake balance.

278 By reducing the length of the vehicle, the wheel-to-base distance  $l/w$  is decreased. From  $l/w = 3$   
 279 with decreasing  $l/w$ , a rapid quadratic increase in  $\Delta\overline{C}_B$  is observed until the smallest  $l/w$  is reached,  
 280 maximally leading to a base drag increase of  $\sim 12\%$ . This suggests the emergence of additional  
 281 near-wake interactions between the rear wheels and the vehicle wake resulting in an extra base drag  
 282 increase.

283 In figure 3(b), we consider the total drag acting on the whole vehicle model (wheel drag is not  
 284 weighted). In the plateau, the drag increase from the baseline case is  $\sim 15\%$ . With decreasing  $l/w$ ,  
 285 the wheels maximally lead to a  $\sim 22\%$  drag increase at the minimum  $l/w$ . The  $\Delta\overline{C}_D$  evolution  
 286 with  $l/w$  is very similar to the  $\Delta\overline{C}_B$  evolution as shown before in figure 3(a) but presents an overall  
 287 upward shift of  $\sim 0.024$ . The shift is due to the drag increase at the vehicle surfaces except at the  
 288 base, for example the wheelhouse drag and/or the change in pressure at the front surfaces. More  
 289 exactly, we observe that  $\Delta\overline{C}_D(l/w) = 0.024 + \Delta\overline{C}_B(l/w)$  as depicted by showing the relationship  
 290 between the total drag  $\Delta\overline{C}_D$  and the base drag  $\Delta\overline{C}_B$  in figure 3(c). This means that with variation  
 291 in  $l/w$ , the base drag increase is the only source of total aerodynamic drag increase.

292 By comparing the configuration R with S in figure 3, it is shown that the base drag and total  
 293 drag are not sensitive to the geometrical details of the wheels (wheel drag being not weighted).  
 294 In particular, for the more realistic wheel shape R, we observe a slight increase of base drag at  
 295 the plateau and the drag sensitivity with decreasing  $l/w$ . In what follows, comparisons of detailed  
 296 measurements between the two configurations will be presented.

#### 297 4.2. Global forcing of vehicle wake by the wheels

298 We first focus on the base pressure increase induced by the wheels for the longest body. By installing  
 299 rotating wheels on a Windsor model, Pavia & Passmore (2017) have shown that the vehicle wake is  
 300 modified from a well-balanced one to an asymmetric one dominated by a bottom recirculating flow.  
 301 We therefore suspect the wheels to act as underflow perturbations modifying the global equilibrium  
 302 of the wake. The largest wheel-to-base distance is considered here in order to focus on these global  
 303 changes. The local interactions will be considered in the next section.

304 Barros *et al.* (2017) have shown that a systematic variation of the wake equilibrium can be  
 305 induced by placing different kinds of perturbations in the underflow. In order to obtain a large span  
 306 of wake orientations for the reference body (that is to say without rotating wheels), our choice is  
 307 then to use the same strategy – see also Haffner *et al.* (2020, 2022); Legeai & Cadot (2020) – by  
 308 placing a circular cylinder of varying diameter  $d$  (from  $d/H = 0$  to 0.087) spanning the whole width  
 309 of the baseline vehicle at  $x/H = -1$  on either the top or bottom surface.

310 A large number of cases are selected in order to have a good description of the effect of global  
 311 equilibrium modification on the reference body. Their joint p.d.f. and mean base pressure distri-  
 312 butions are shown in figure 4(a). The whole bifurcation scenario with a competition between the  
 313 vertical static asymmetry and the horizontal bi-modal asymmetry is observed. By increasing the  
 314 size of the bottom (top) perturbing cylinder, the vertical asymmetry is gradually increased with a  
 315 disappearance of the bi-modal dynamics of the baseline situation. The competition between these  
 316 two asymmetries is then shown in figure 4(b) by the relationship between  $\overline{z_b/H}$  and  $|\overline{y_b/H}|$ . For the  
 317 baseline case and the cases perturbed by cylinder, the relationship follows approximately an elliptic  
 318 shape, as pointed out by the elliptic model proposed by Bonnavion & Cadot (2018) and used in  
 319 Lorite-Díez *et al.* (2020).

320 For three-dimensional wakes, these different asymmetries lead to important variations of base  
 321 drag (see Grandemange *et al.* (2013) and Haffner *et al.* (2020) for different suggestions of the drag  
 322 generation mechanisms). For an Ahmed body with a base aspect ratio of  $H/W < 1$  similar to the  
 323 present model, it is often measured that the wake presenting mean vertical symmetry and horizontal  
 324 bi-stable asymmetry has the least base drag (Bonnnavion & Cadot, 2018; Haffner *et al.*, 2020). The  
 325 relationship between the vertical wake asymmetry  $\overline{z_b/H}$  and the base drag variation caused by the  
 326 cylinder  $\Delta\overline{C}_B$  is shown in figure 4(c). It shows that the baseline case with small  $|\overline{z_b/H}|$  presenting

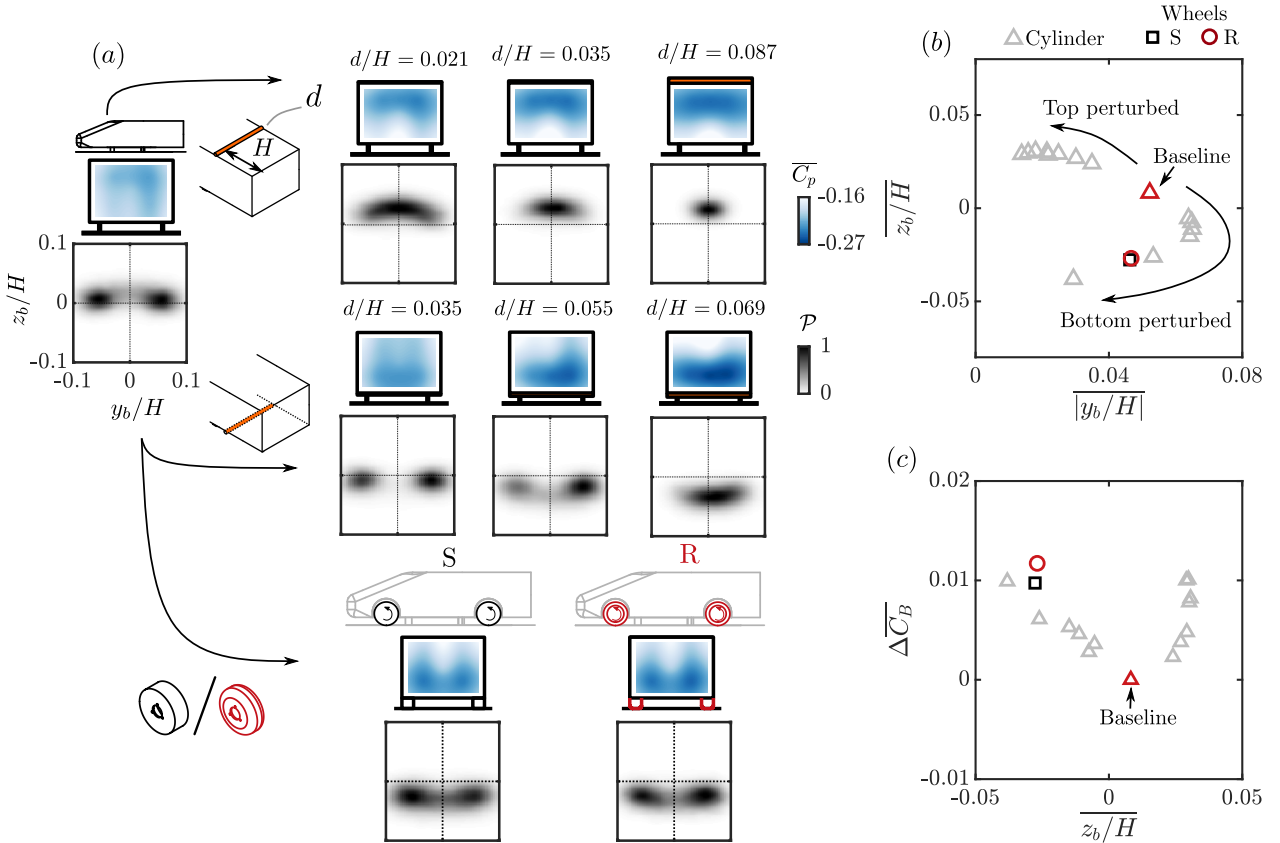

Figure 4: Longest baseline vehicle (wheel-to-base distance  $l/w = 3.58$ ) perturbed either by spanwise cylinder or wheels. (a) Effect of spanwise perturbing cylinder or wheels on the base pressure distribution and joint p.d.f. of the base CoP position. S and R represent, respectively, sharp-edged-shoulder wheels and rounded-shoulder wheels. The cylinder of varying diameter  $d$  is placed horizontally at  $x/H = -1$  on either the top or bottom surface of the vehicle. (b) Mean vertical position of the base CoP  $z_b/H$  versus mean absolute value of the horizontal base CoP position  $|y_b/H|$  for the baseline vehicle perturbed either by spanwise cylinder or wheels. (c) Base drag  $\Delta \overline{C_B}$  versus  $z_b/H$  for the same cases in (b).

327 horizontal bi-modal dynamics has the least mean base drag. When the size of the top/bottom  
 328 cylinder is increased and therefore the vertical asymmetry is enhanced, the base drag is increased  
 329 by maximally 5%.

330 Having this database for the reference body, we are now in a position to examine the effect of the  
 331 wheels. When the wheels, either S or R, are installed, it is shown in figure 4(a) that the mean base  
 332 pressure distribution is modified from a relatively uniform one with vanishing vertical asymmetry  
 333 to an uneven one with an obvious positive vertical pressure gradient. More generally, the mean  
 334 value of the vertical CoP position  $z_b/H$  is decreased by the wheels. Meanwhile, it is noted that the  
 335 base pressure distributions and the joint p.d.f. of the wheel cases are very similar to that of the  
 336  $d/H = 0.055$  case. In figure 4(b), it is found that the wheel cases follow the relationship portrayed  
 337 by the cylinder cases, indicating that the wheels play the same role as the underflow perturbing  
 338 cylinder on the wake asymmetry. Focusing on figure 4(c) where the relationship between the vertical  
 339 asymmetry and the base drag is discussed, we notice the wheel case follows approximately the trend  
 340 measured using the cylinder.

341 The wake flow is now investigated in figure 5 to understand how the wake is modified by the  
 342 wheels. In figure 5(a), the mean streamlines and turbulent kinetic energy  $k$  in the symmetry plane  
 343 of the longest vehicle are presented. In accordance with the pressure measurements, the wheels,  
 344 either type S or R, reorganize the structure of the mean vehicle wake, leading to a strong bottom-  
 345 dominated recirculating flow. The wake reorganization increases the low-pressure imprint at the  
 346 bottom part of the recirculating flow on the base. At the same time, the interaction mechanism in  
 347 asymmetric wakes as proposed in Haffner *et al.* (2020) is enhanced by the growth of the upward

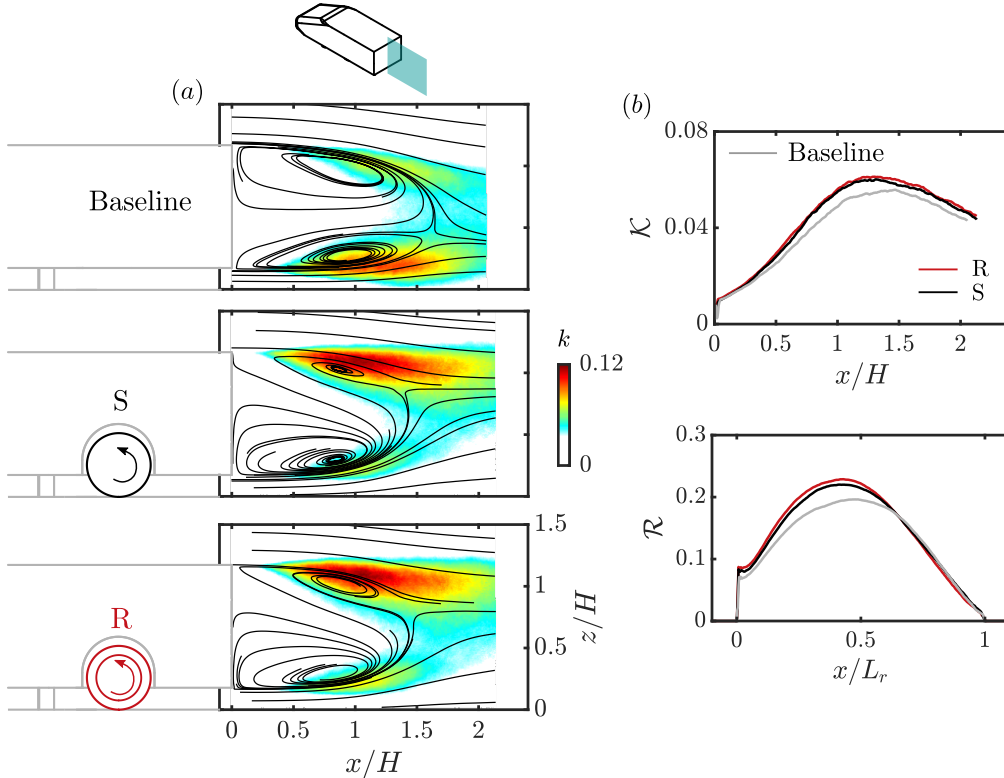

Figure 5: Effect of wheels on the wake of the longest baseline vehicle. S and R represent, respectively, sharp-edged-shoulder and rounded-shoulder wheels. (a) Mean streamlines superimposed on the turbulent kinetic energy  $k$  distribution. (b) Streamwise evolution of the integrated turbulent kinetic energy  $\mathcal{K}$  and the recirculation strength  $\mathcal{R}$  for the cases in (a), Gray lines represent the baseline case having no wheels.

348 cross-flow momentum, evidenced by the stronger flow fluctuation in the top shear layer. This aspect  
 349 is shown in figure 5(b) by integrating the turbulent kinetic energy  $k$  across the measurement plane:

$$\mathcal{K}(x) = \int_0^{z_{max}} k(x, z) dz. \quad (7)$$

350 This quantity reveals the global enhancement of the turbulent fluctuation in the wake. It leads  
 351 to changes in the intensity of the recirculating flow, which is quantified by defining a quantity:

$$\mathcal{R}(x) = \int_{\overline{u_x} \leq 0} \sqrt{\overline{u_x^2} + \overline{u_z^2}} dz, \quad (8)$$

352 As shown in figure 5(b), the wheels, either type S or R, lead to an overall enhancement of the  
 353 recirculating motion from the baseline case, with the maximum of the recirculating strength  $\mathcal{R}$   
 354 increases by  $\sim 12\%$ . This enhancement produces a lower pressure at the center of the recirculation  
 355 region in accordance with the lower pressure footprint measured on the base.

#### 356 4.3. Near-wake interactions for small wheel-to-base distance

357 In this section, the investigation is focused on the flow mechanisms resulting in the  $\Delta \overline{C_B}$  increase  
 358 with decreasing  $l/w$  for  $l/w < 3$ . It is important to note here that the global forcing of the vehicle  
 359 wake found in the last section is also measured for all the  $l/w$  cases in this section.

360 We start by examining in figure 6(a) the base pressure distribution for the longest vehicle  
 361 ( $l/w = 3.58$ ) and the shortest vehicle ( $l/w = 0.65$ ). On the right-hand side of the base, the  
 362 distribution of pressure difference  $\Delta \langle \overline{C_p} \rangle$  with respect to the corresponding baseline case is also  
 363 shown for comparison. For both configurations S and R, the base pressure decreases when  $l/w$   
 364 is reduced. The portion of the base that contributes to the increase in  $\Delta \overline{C_B}$  can be obtained by  
 365 comparing the  $\Delta \langle \overline{C_p} \rangle$  distributions. A decrease in  $\Delta \langle \overline{C_p} \rangle$  is observed at the bottom half of the base

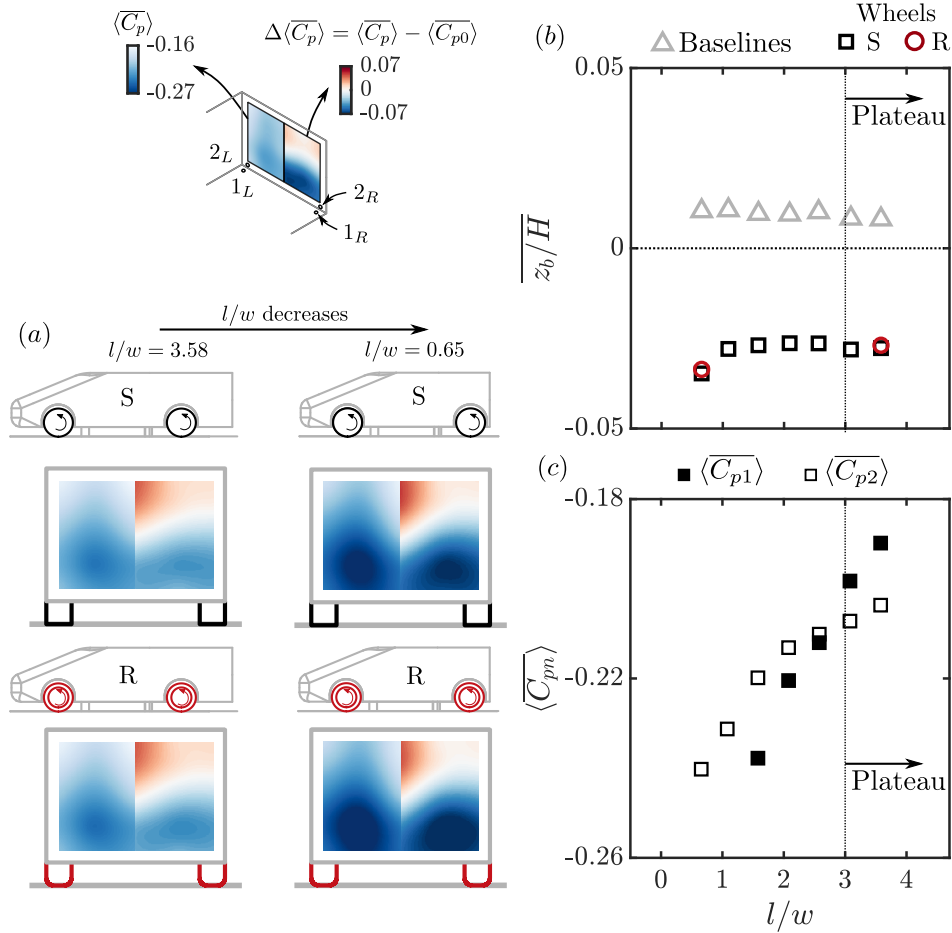

Figure 6: Effect of the reduction in the wheel-to-base distance  $l/w$  on the base pressure. S and R represent, respectively, sharp-edged-shoulder and rounded-shoulder wheels. (a) Base pressure distributions for the smallest and the largest  $l/w$  cases, the mean values and the differences with respect to the corresponding baseline case are respectively presented at the left-hand and right-hand sides of the base. (b) Evolution of the mean vertical position of the base CoP  $z_b/H$  with  $l/w$ , the values for the baseline cases (no wheels) are shown for comparison using triangles. (c) Comparison between the evolution of  $\langle C_{p1} \rangle$  and  $\langle C_{p2} \rangle$ , the location of the pressure taps are schematically shown above (a).

366 near the rear wheels. This region of base pressure decrease is also illustrated in figure 6(b) by the  
 367 continuous decrease in  $z_b/H$  with decreasing  $l/w$  at  $l/w < 3$ .

368 Now the pressure in the vicinity of the rear wheels is considered. The pressure measurements  
 369 at the taps numbered  $1_L$  and  $2_L$  ( $1_R$  and  $2_R$ ), located in the symmetry plane of the left-hand  
 370 (right-hand) side wheels (see the sketch in figure 6), are used for a comparison in figure 6(c). These  
 371 pressure taps are located on both sides of the bottom trailing edge, representing the pressure levels  
 372 behind the rear wheels and at the base near the rear wheels. It should be noted here that the taps  
 373 numbered 1 are always located at  $x/H = -0.07$  for different vehicle lengths. For the shorter cases  
 374  $l/w = 0.65$  and  $1.58$ , pressure taps  $1_L$  and  $1_R$  are not available due to mechanical constraints. In  
 375 the plateau ( $l/w > 3$ ),  $\langle C_{p1} \rangle$  is higher than  $\langle C_{p2} \rangle$ . For a canonical separating flow, the pressure  
 376 condition at separation is similar to the observation here with the separating streamline inducing  
 377 a lower pressure inside the recirculation region (Bradshaw, 1973). On the other hand, in the drag-  
 378 sensitive regime  $l/w < 3$ ,  $\langle C_{p1} \rangle$  is lower than  $\langle C_{p2} \rangle$ . The difference  $\langle C_{p2} \rangle - \langle C_{p1} \rangle$  increases with  
 379 decreasing  $l/w$ .

380 These observations point out the close relationship between the pressure decrease at the model  
 381 base and the increasing influence from the rear wheels when the wheel-to-base distance  $l/w$  is  
 382 decreased in the drag-sensitive regime  $l/w < 3$ . The streamwise development of the rear wheel  
 383 wake is therefore of particular importance here. We then define a new reference frame in figure  
 384 7(a) in order to examine this. The rearmost location of the part of the rear wheels exposed to

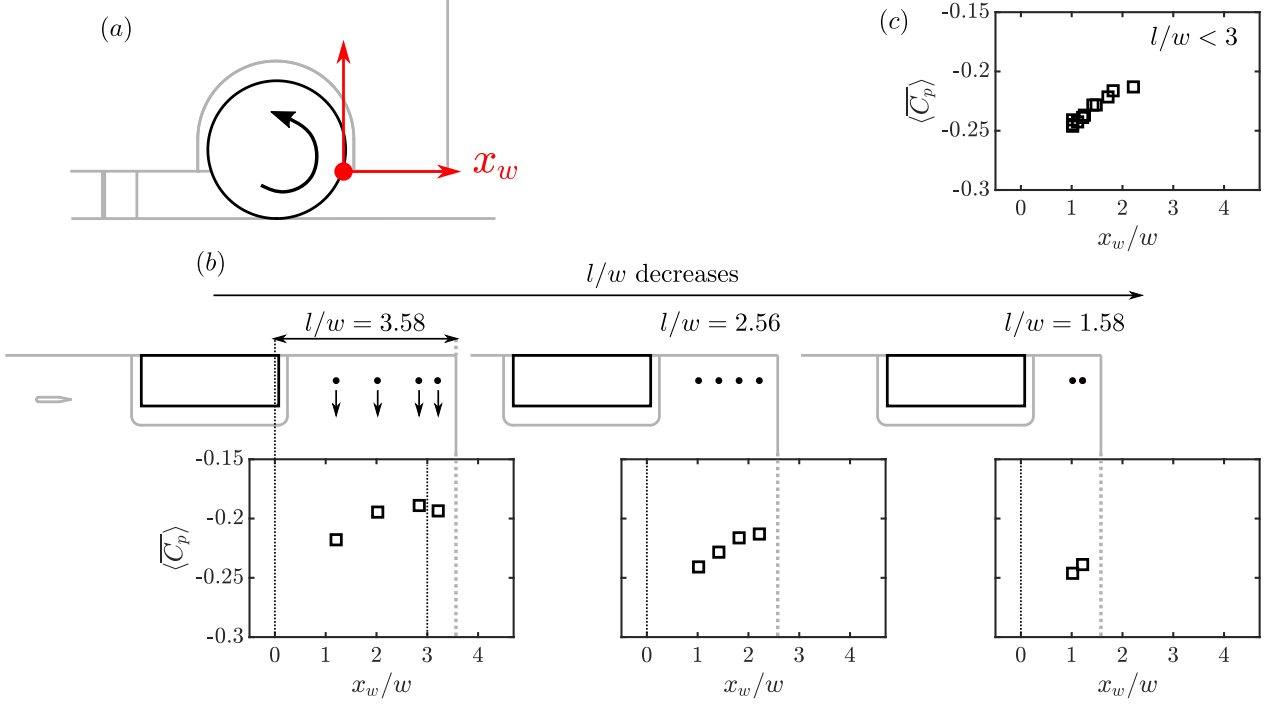

Figure 7: Streamwise pressure evolution in the wake of the rear wheels (sharp-edged-shoulder ones). (a) Definition of a wheel-fixed coordinate system. (b) Evolution of  $\langle \overline{C_p} \rangle$  as a function of  $x_w$  for three different  $l/w$  cases. (c) Superposition of the  $\langle \overline{C_p} \rangle$  evolution for all the cases in the drag-sensitive regime  $l/w < 3$ .

385 the underflow is set as the origin of this frame with  $x_w = 0$ . For each  $l/w$  case, as shown in  
386 the sketch in figure 7(b), several pressure taps are located under the vehicle in the symmetry  
387 planes of the rear wheels. These pressure measurements are plotted against the distance from the  
388 measurement location to the rear wheels  $x_w$  in figure 7(b). Only S configuration is presented for  
389 brevity. For case  $l/w = 3.58$  ( $\max(l/w)$ ), a rapid pressure increase with increasing  $x_w/w$  is measured  
390 at  $x_w/w < 3$  which corresponds to the near-wake region of the rear wheels. For decreasing  $l/w$ ,  
391 the bottom trailing edge of the vehicle approaches the rear wheels and is gradually influenced by  
392 the near-wake region of the rear wheels. This is the reason for the decrease of  $\langle \overline{C_{p1}} \rangle$  in the drag-  
393 sensitive regime  $l/w < 3$ . For all the cases in the drag-sensitive regime ( $l/w < 3$ ), the streamwise  
394 pressure developments are gathered together in figure 7(c). It is found that all these cases collapse  
395 approximately on the same evolution. This means that the wakes of the rear wheels keep their mean  
396 properties in the drag-sensitive regime when  $l/w$  is varied. Again, we notice a decrease in pressure  
397 with decreasing  $x_w/w$  at  $x_w/w < 3$ .

398 Noticeably, the bottom trailing edge of the vehicle experiences a gradual increase of periodic  
399 dynamics with decreasing  $l/w$ , which is captured by the unsteady pressure sensors numbered 1 and  
400 2. The evolution with  $l/w$  of the premultiplied spectra of the pressure signals obtained from the  
401 pressure taps 1 and 2 are shown in figure 8(a) and (b). Pressure sensors 1 measure a rapid growth  
402 in energy at  $St_w = fw/U_0 = 0.15$  (here  $w$  is the width of the wheels) with decreasing  $l/w$  in the  
403 range  $l/w < 3$ . This growing influence of the wheel wake dynamics is also observed at the base (see  
404 figure 8b). It is noted here that [Croner et al. \(2013\)](#) experimentally measured a peak at  $St_w = 0.14$   
405 downstream an isolated rotating wheel wake. With the help of numerical simulations, they found  
406 the same peak in the spectrum of the side force. Recently, this  $St_w$  was also measured by [Patel et al.](#)  
407 [\(2022\)](#). Therefore, the peak measured in the present study may represent the horizontal periodic  
408 motion of the rear wheel wake. Finally, a peak at a relatively low frequency, about  $St_w = 0.022$   
409 (corresponding to  $St_W = fW/U_0 = 0.16$ , where  $W$  is the width of the vehicle), is measured at the  
410 base. This frequency matches with the horizontal periodic dynamics of the vehicle wake measured  
411 for example in [Grandemange et al. \(2013\)](#) and [Lorite-Díez et al. \(2020\)](#). For configuration R, figure  
412 8(c) shows the premultiplied spectrum of the pressure signal obtained from the pressure taps 2.  
413 We observe the same evolution as in figure 8(b) for configuration S. The low-frequency peak at



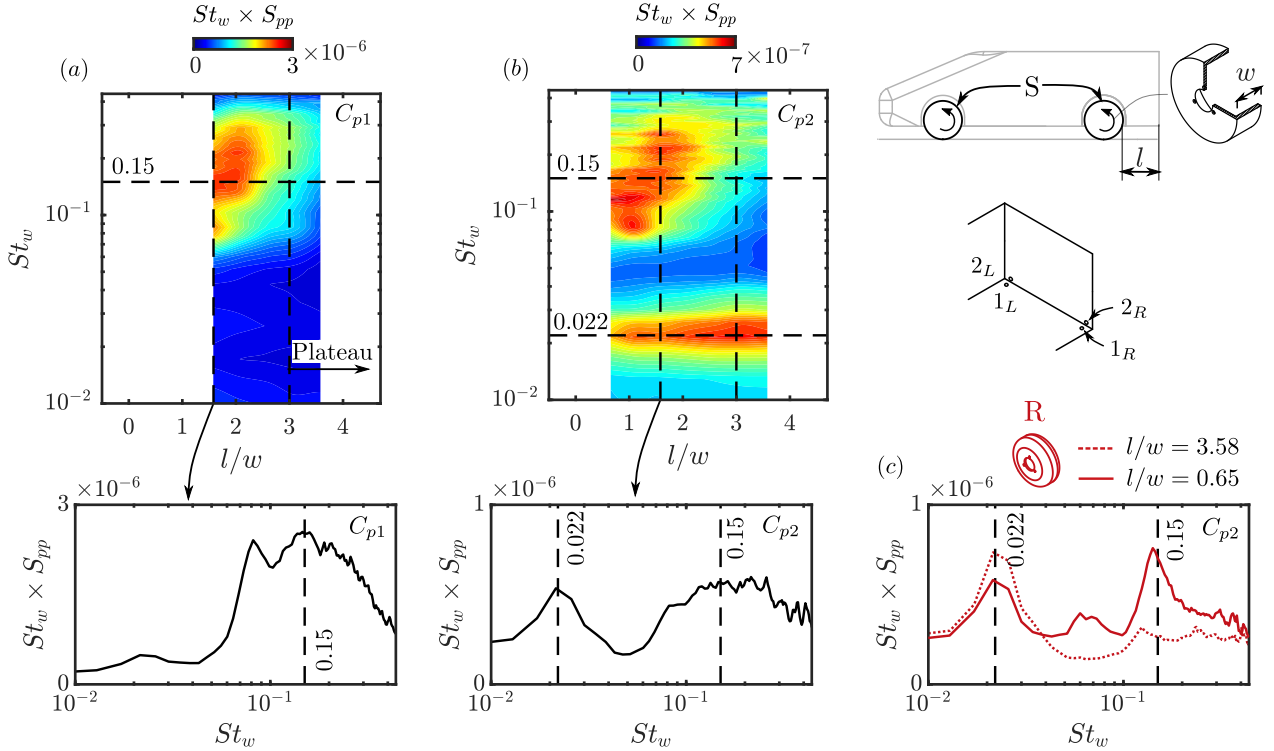

Figure 8: For configuration S: evolution of the premultiplied spectra of  $C_{p1}$  (a) and  $C_{p2}$  (b) with the wheel-to-base distance  $l/w$ . At  $l/w = 1.58$ , the spectra are also shown. For configuration R: premultiplied spectrum of  $C_{p2}$  (c) for the maximum and the minimum  $l/w$ .

414  $St_w = 0.022$  driven by the vehicle wake, is observed in both situations  $l/w = 3.58$  and  $0.65$ . The  
 415 signature of the wheel wake dynamics at  $St_w = 0.15$  is only detected for  $l/w = 0.65$ .

416 The velocity fields are investigated in order to understand the modifications in the vehicle wake  
 417 and to reveal the flow mechanisms responsible for the  $\Delta \overline{C_B}$  increase with decreasing  $l/w$  for  $l/w < 3$ .  
 418 The streamwise velocity  $\overline{u_x}$  downstream the vehicle is presented in figure 9(a). Similar mean velocity  
 419 fields obtained for rounded-shoulder wheels are not shown for brevity. First of all, in the symmetry  
 420 plane of the vehicle  $y/H = 0$ , no obvious change in the wake topology is noticed. However, by  
 421 integrating the flow momentum inside the recirculation region, the recirculation strength  $\mathcal{R}$  shows  
 422 an important change in figure 9(b). From  $l/w = 3.58$  to  $l/w = 0.65$ , the maximum of  $\mathcal{R}$  is increased  
 423 by  $\sim 12\%$ . This is valid for both configurations S and R, between which only slight differences are  
 424 noticed.

425 Local velocity measurements shown in figure 9(a), downstream of the left-hand wheels, reveal  
 426 a more pronounced difference between the cases. In the symmetry plane of the left-hand wheels,  
 427 the streamwise velocity  $\overline{u_x}$  below the vehicle wake is lower for  $l/w = 0.65$  than  $l/w = 3.58$ . This  
 428 reduces significantly the mean shear between the vehicle wake and the wakes of the rear wheels as  
 429 illustrated in figure 9(c) by plotting the  $\overline{u_x}$  distributions along  $x/H = 0.03$  in this plane. It is shown  
 430 that no matter the type of wheels, the decrease of  $l/w$  always reduces the mean shear between the  
 431 vehicle wake and the wakes of the rear wheels.

432 Along with the mean shear strength with reducing  $l/w$ , an important remark is that a mean  
 433 mass transfer from the vehicle wake to the wakes of the rear wheels is observed. In figure 10, the  
 434 mass transfer is illustrated by the distribution of the mean vertical velocity  $\overline{u_z}$  in the symmetry plane  
 435 of the left-hand wheels for the same cases as in figure 9(a). A clear difference is found near the base  
 436 of the vehicle. For the  $l/w = 0.65$  case, there is a downward motion from the recirculation region of  
 437 the vehicle toward the ground indicated by an overall negative  $\overline{u_z}$  in the flow downstream of the rear  
 438 wheel. This feature is not observed for the  $l/w = 3.58$  case. The difference is better illustrated by  
 439 plotting the distribution of  $\overline{u_z}$  along  $x/H = 0.03$  in figure 10(b) for both the configurations S and R.  
 440 For the cases  $l/w = 3.58$ , we notice a sharp change in  $\overline{u_z}$  at the location of the shear  $z/H = G/H$   
 441 with different signs above and below this location. On the other hand, case  $l/w = 0.65$  always

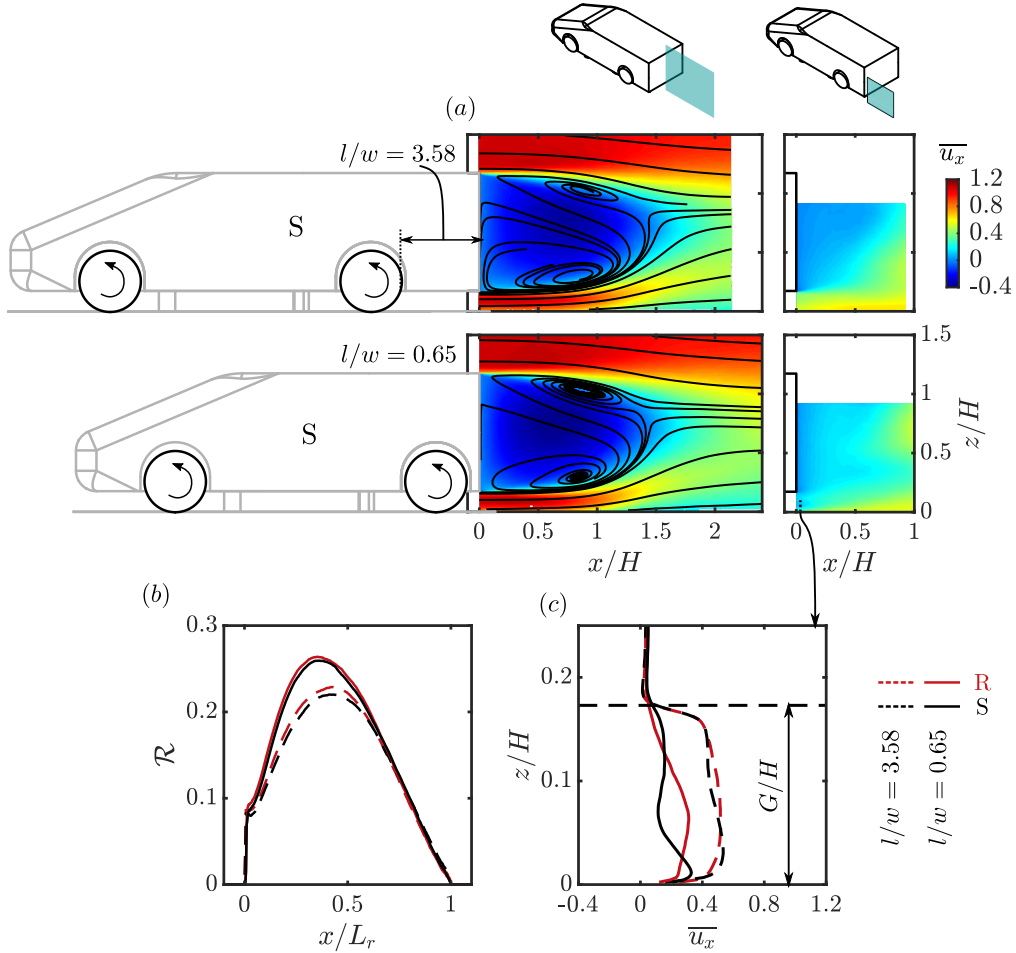

Figure 9: Effects of  $l/w$  reduction from the maximum  $l/w$  ( $l/w = 3.58$ ) to the minimum  $l/w$  ( $l/w = 0.65$ ) on the mean flow downstream of the vehicle. S and R represent, respectively, sharp-edged-shoulder and rounded-shoulder wheels. (a) Distributions of mean streamwise velocity  $\overline{u_x}$  in the symmetry plane of the vehicle at  $y/H = 0$  and of the left wheels at  $y/H = -0.58$  for the configuration S. (b) Recirculation strength  $\mathcal{R}$  for the configurations S and R. (c)  $\overline{u_x}$  profiles along  $x/H = 0.03$  in the symmetry plane of the left wheels for the configurations S and R.

442 present a negative  $\overline{u_z}$  near  $z/H = G/H$ .

443 The streamwise span of the mean mass transfer is quantified in figure 10(c) by plotting the mean  
 444 vertical velocity  $\overline{u_z}$ , at the ground clearance height  $G/H$ , as a function of either the distance from  
 445 the base  $x/H$  or the distance from the rear wheels  $x_w/w$ . The length of the mass exchange interface  
 446 approximately ends at  $x_w/w = 3$ . It is reminded here that this region behind the rear wheels with  
 447  $x_w/w < 3$  was shown to experience a lower pressure than the wake of the vehicle (see figure 6c).  
 448 With variation in  $l/w$ , the length of the region is not expected to be modified since the pressure in  
 449 the rear wheel wake is measured to be not changed in figure 7(c). The physical picture is thus that  
 450 the rear wheel wakes impose a lower static pressure and a downstream region having the ability to  
 451 induce mass exchange from the main wake of the vehicle. With the length of this region of order  
 452  $x_w/w = 3$ , a decrease of the wheel-to-base distance  $l/w$  then induces a higher mass transfer and  
 453 a larger drag increase. Further comments on the relation between the mass transfer and the base  
 454 drag sensitivity are provided in appendix B by adapting the model of Bao *et al.* (2022).

455 For the  $l/w = 0.65$  case, additional velocity measurements at  $x/H = 0.03$  are shown in figure  
 456 11(a) to show the flow structures generated by the wheels and to provide the information of mass  
 457 exchange in the horizontal direction of the interaction interface. The distributions of the mean  
 458 velocity magnitude  $\overline{U}$  are shown for the two cases S and R. In figure 11(a), we see clearly several  
 459 flow regions that experience a deficit of mean longitudinal momentum. The wake of the left-hand  
 460 rear wheel has the same velocity level as the recirculation region behind the vehicle. Another region

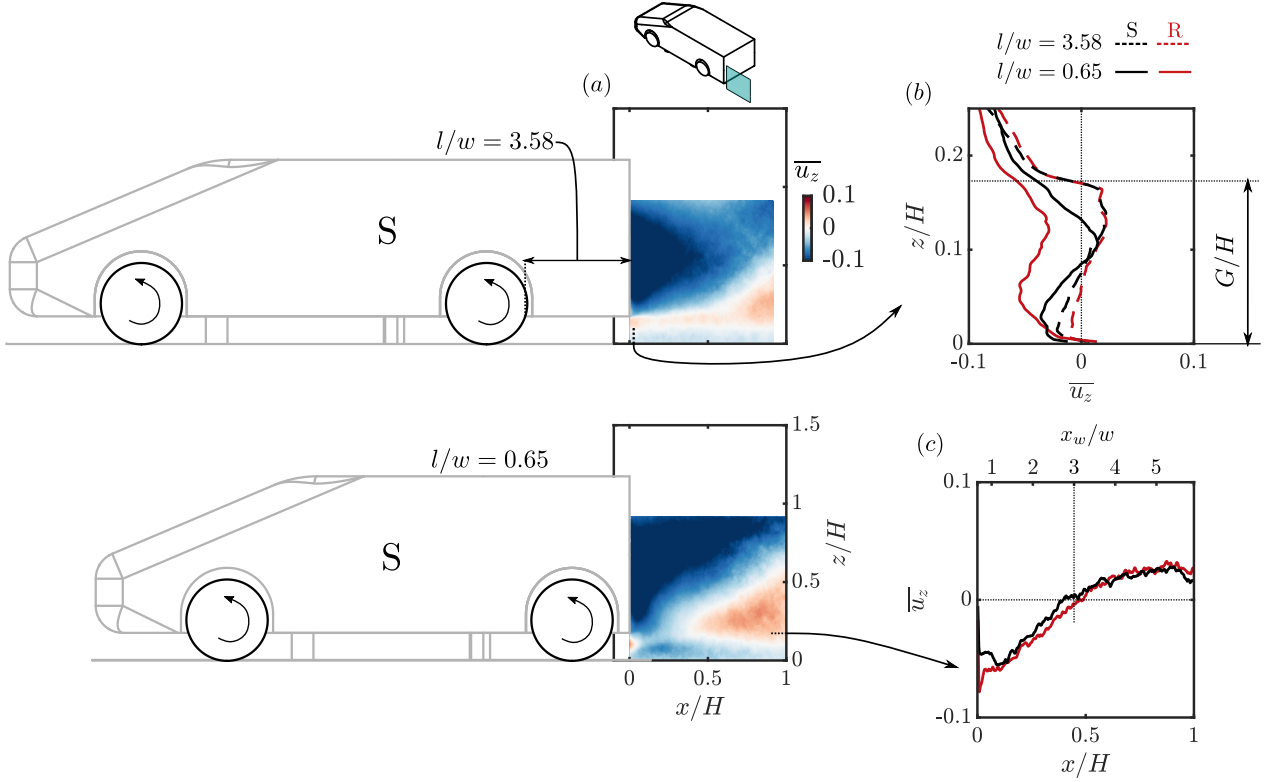

Figure 10: (a) Effect of  $l/w$  reduction on the mean vertical velocity  $\overline{u_z}$  in the symmetry plane of the left-hand wheels for the configuration S (sharp-edged-shoulder wheels). (b) Vertical profiles of  $\overline{u_z}$  at  $x/H = 0.03$  for the two configurations S and R (rounded-shoulder wheels). (c)  $\overline{u_z}$  distributions at the height of the ground clearance  $z/H = G/H$  for the  $l/w = 0.65$  cases of the two configurations.

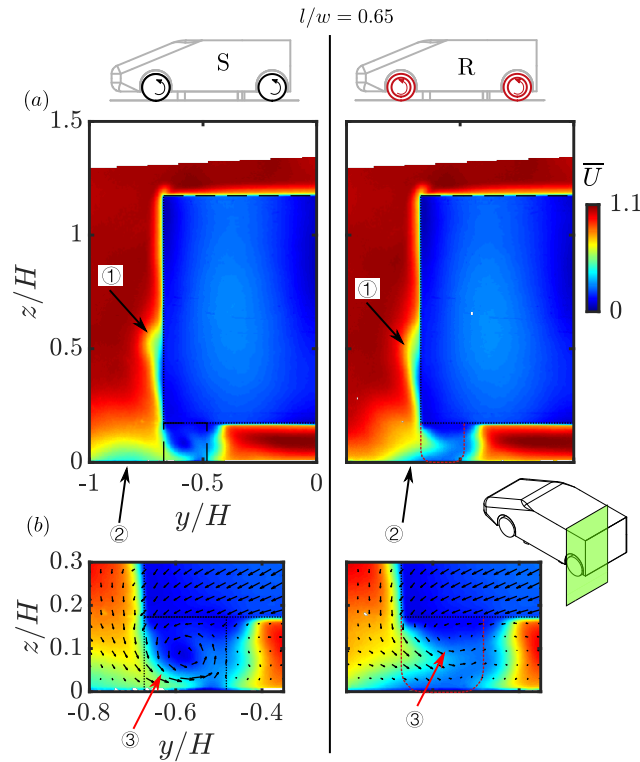

Figure 11: For the shortest vehicle case  $l/w = 0.65$ : (a) Mean streamwise  $\overline{u_x}$  velocity distributions in the cross-flow plane at  $x/H = 0.03$ , S and R represent, respectively, sharp-edged-shoulder and rounded-shoulder wheels. (b) Zoom views of the cases in (a) superimposed by in-plane mean velocity vectors.

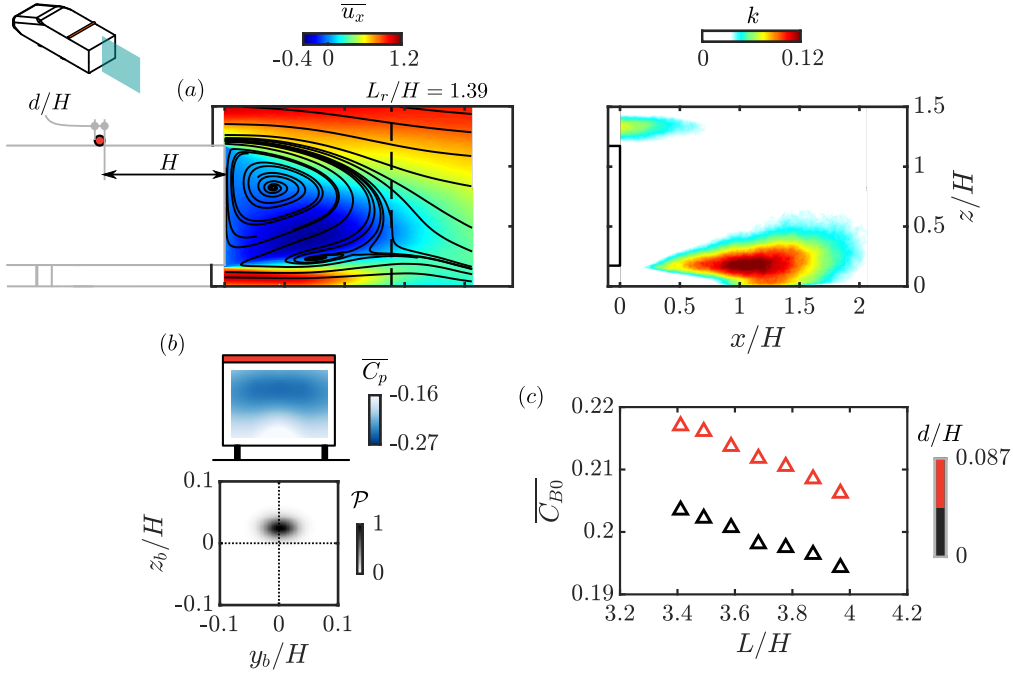

Figure 12: Baseline flow for the longest vehicle  $L/H = 3.97$  perturbed by a circular cylinder  $d/H = 0.087$  at  $x/H = -1$  on the top surface. (a) Mean streamwise velocity  $\bar{u}_x$  and turbulent kinetic energy  $k$  in the symmetry plane of the vehicle  $y/H = 0$ . (b) Mean base pressure distribution and the Joint probability density function (p.d.f.) of the base CoP position. (c) Evolution of the base drag  $\bar{C}_{B0}$  with the length of the vehicle  $L/H$ , the baseline cases from figure 2 with  $d/H = 0$  are shown for comparison.

461 (marked by ①) is observed for both configurations S and R behind the rear wheelhouse. A third  
 462 region (marked by ②), is situated at the left-hand side of the wheel. This region is clearly visible for  
 463 configuration S while for configuration R it is closer to the left-hand shear layer of the wheel. When  
 464 looking closer at the flow behind the wheel in figure 11(b), a counter-clockwise mean streamwise  
 465 vortical structure (marked by ③) is depicted by the in-plane mean velocity vectors. This structure  
 466 is noticed for both configurations and appears to be less intense for configuration R than for S. In  
 467 addition, the velocity vectors at the height of the ground clearance show that the mass transfer  
 468 is always from the vehicle wake to the wakes of the rear wheels. The span of the mass exchange  
 469 surface in the spanwise direction is approximately the width of the wheel.

470 We now compare the wheel wake structure in the present work with that in previous studies. The  
 471 experimental measurements behind the front wheel of a car model in Wäschle (2007) are selected for  
 472 the comparison (see figure 7c in Wäschle (2007)). A moving ground facility was used and the wheels  
 473 are solid due to the small scale of the model. Recently in Josefsson *et al.* (2022b), the measurements  
 474 were confirmed by a combination of experiments and numerical simulations using deformable tires.  
 475 The measurement plane was located at  $0.6d_w$  downstream of the wheel axle, where  $d_w$  represents  
 476 the diameter of the wheel. In our study, the measurement plane is located at  $0.8d_w$  downstream  
 477 of the wheel axle. First, the two regions of momentum loss ① and ② were measured. In Wäschle  
 478 (2007), additional numerical simulations were able to reveal that two streamwise vortical structures  
 479 are the reasons for the momentum loss regions. In addition, the vortical structure ③ behind the  
 480 wheel was measured with the same rotation direction as the present work. Finally, the present work  
 481 is found also in accordance with the vortex skeleton model proposed by Regert & Lajos (2007) using  
 482 RANS simulations and confirmed by Krajnović *et al.* (2011) based on Large-eddy simulations.

## 483 5. Influence of initial asymmetry of the baseline wake

484 In this section, we examine the wheel-vehicle interactions based on a different baseline wake. This  
 485 baseline wake is derived from the previous one by placing a perturbing cylinder having a diameter of  
 486  $d/H = 0.087$  on the top surface (at  $x/H = -1$ , see section 4.2) for the seven different vehicle lengths

$L/H$	3.41	3.49	3.59	3.68	3.78	3.87	3.97
$\overline{C_{B0}}$	0.217	0.216	0.214	0.212	0.211	0.209	0.206
$\overline{C_{D0}}$	0.295	0.298	0.295	0.295	0.294	0.292	0.292

Table 4: Evolution of the mean aerodynamic coefficients with the model length  $L$ .

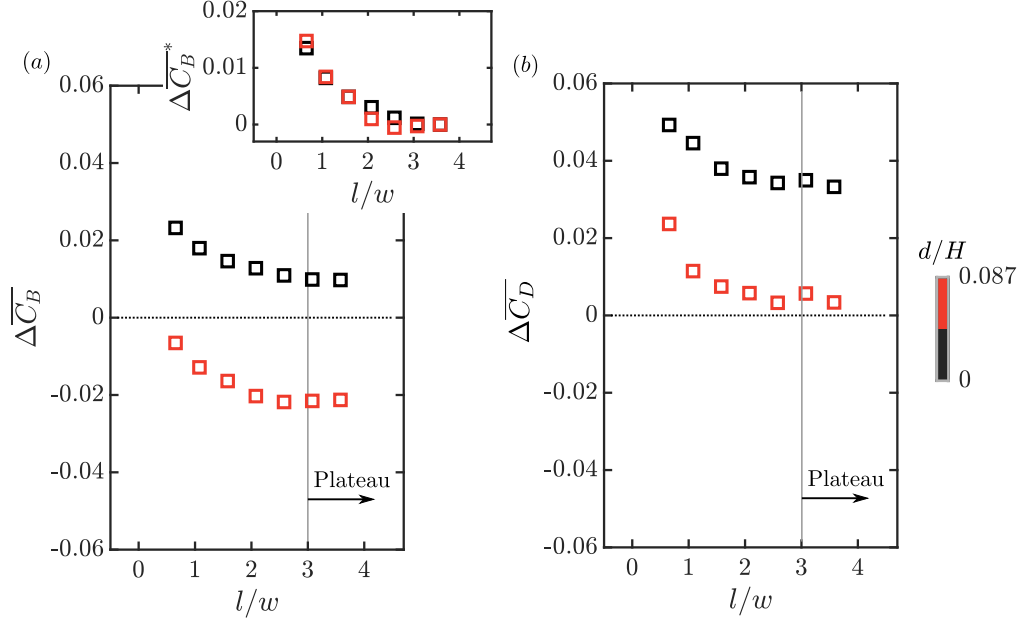

Figure 13: Based on a different baseline wake (top perturbing cylinder  $d/H = 0.087$  used here): (a) Base drag  $\Delta\overline{C_B} = \overline{C_B} - \overline{C_{B0}}$  and (b) total drag  $\Delta\overline{C_D} = \overline{C_D} - \overline{C_{D0}}$  of the vehicle perturbed by sharp-edged-shoulder wheels as a function of the wheel-to-base distance  $l/w$ , the base drag variant  $\Delta\overline{C_B}^* = \Delta\overline{C_B} - \Delta\overline{C_B}(\max(l/w))$  versus  $l/w$  is also shown in (a).

487  $L/H$ . A picture of this baseline flow is presented in figure 12(a) by showing the measurements for  
488 the longest vehicle. It is found that the cylinder alters the vehicle wake from a well-balanced one to  
489 a vertical asymmetric one dominated by a top recirculating flow. This is shown by both the mean  
490 streamlines and the turbulent kinetic energy  $k$  in the symmetry plane of the vehicle. In addition,  
491 the horizontal bi-modal dynamics of the wake is inhibited and the wake is locked to a vertical static  
492 asymmetric state. The aim of introducing such an asymmetric baseline wake is to generalize the  
493 findings described previously, since the wakes of square-back road vehicles present different vertical  
494 asymmetries. The mean base drag  $\overline{C_{B0}}$  and total drag  $\overline{C_{D0}}$  coefficients are displayed in table 4. The  
495 increase in base drag with decreasing vehicle length  $L/H$  is again observed for this baseline (also  
496 plotted in figure 12c).

497 The sharp-edged-shoulder wheels S are then tested on the present baseline. The effects on the  
498 base drag  $\Delta\overline{C_B} = \overline{C_B} - \overline{C_{B0}}$  and on the total drag  $\Delta\overline{C_D} = \overline{C_D} - \overline{C_{D0}}$  are shown respectively in  
499 figure 13(a) and (b). The results discussed before in the previous sections (named as  $d/H = 0$ )  
500 are presented for comparison. It is shown in figure 13(a) that the  $\Delta\overline{C_B}$  evolution for the new  
501 configuration presents an overall downward shift. The wheels now play an opposite role on the base  
502 drag in the plateau with a base drag decrease of  $\sim 9\%$ . From the plateau with decreasing  $l/w$ ,  
503 the same evolution as that of the  $d/H = 0$  configuration is observed. This is evidenced by defining  
504 a variant of base drag variation  $\Delta\overline{C_B}^* = \Delta\overline{C_B} - \Delta\overline{C_B}(\max(l/w))$ , where the two curves collapse  
505 approximately. When the total aerodynamic drag is considered in figure 13(b), an overall upward  
506 shift of  $\sim 0.024$  from the  $\Delta\overline{C_B}$  evolution in figure 13(a) is noticed. This is similar to the  $d/H = 0$   
507 configuration.

508 An examination of the mean wake flow is presented in figure 14. The global modifications of the  
509 vehicle wake by the wheels are exemplified using the case with the longest vehicle in figure 14(a). In  
510 contrast to the increase in wake asymmetry observed before for the  $d/H = 0$  configuration in figure

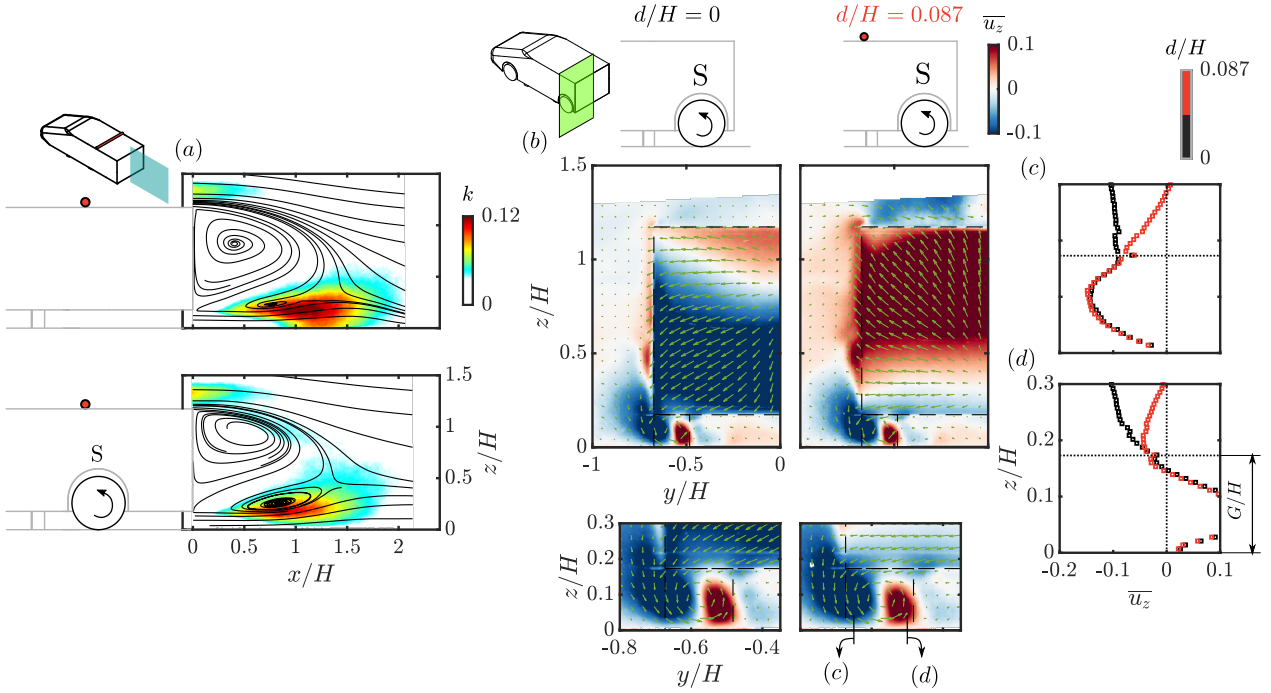

Figure 14: (a) Effect of sharp-edged-shoulder wheels on the longest baseline wake, the vehicle is perturbed with a  $d/H = 0.087$  cylinder at the top. (b) For the shortest vehicle with sharp-edged-shoulder wheels: evolution of the mean vertical velocity  $\bar{u}_z$  with the size of the top-perturbing cylinder  $d$  in the cross-flow plane  $x/H = 0.03$ , the vertical profiles at  $y/H = -0.64$  and  $-0.52$  are shown respectively in (c) and (d).

511 5(a), here we measure a symmetrization of the vehicle wake as shown by the mean streamlines and  
 512 the lower turbulent kinetic energy  $k$  in the bottom shear layer.

513 On the other hand, with decreasing  $l/w$ , the  $\Delta\bar{C}_B$  increase is also accompanied by the emergence  
 514 of the mass exchange between the rear wheel wakes and the vehicle wake for the  $d/H = 0.087$   
 515 configuration. This is shown in figure 14(b) by comparison with the  $d/H = 0$  configuration. The  
 516  $\bar{u}_z$  distributions at  $x/H = 0.03$  for the shortest vehicle are presented. Inside the vehicle wake, the  
 517 recirculating flow is very different for these two configurations. However, the mass exchange velocity  
 518 at the interface  $z/H = G/H$  is not varied significantly. This is depicted by plotting the  $\bar{u}_z$  profiles  
 519 at  $y/H = -0.64$  and  $-0.52$ , respectively, in figures 14(c) and (d). Despite the very different  $\bar{u}_z$   
 520 distributions in the vehicle wake ( $z/H > G/H$ ), the mean vertical velocity  $\bar{u}_z$  at  $z/H = G/H$  is of  
 521 the same level for the two configurations.

522 These results show clearly that wheels have two different effects. On one hand, at the scale  
 523 of the vehicle, they induce a global variation of the wake balance which, according to the initial  
 524 state of the wake, increases or reduces the global drag (note for example that adding wheels is  
 525 always beneficial for the base drag of the vehicle perturbed by the cylinder). On the other hand, for  
 526 moderate wheel-to-base distances, a local interaction driven by the wakes of the wheels takes place.  
 527 This interaction induces a mass transfer from the main wake and is responsible for a drag increase.

## 528 6. Concluding remarks

529 A road vehicle is a complex multi-scale geometry and all flow regions are interacting. Salient features  
 530 of wheel-vehicle interactions and their consequences for drag were considered in this paper. At first  
 531 order, we have shown that two different mechanisms can be distinguished, tentatively sketched in  
 532 figure 15. At the scale of the vehicle, wheels perturb the underflow and induce a global variation  
 533 of the vertical balance of the wake (I in figure 15). According to the state of the initial wake,  
 534 significant base drag increase or decrease is observed. Considering now the scale of the wheels, we  
 535 have shown that the wake region of the rear wheels imposes a low static pressure having the ability  
 536 to induce a mean mass exchange from the main wake of the vehicle to the wakes of the rear wheels if  
 537 the wheel-to-base distance is smaller than a threshold of order  $3w$  ( $w$  is the width of the wheels) in



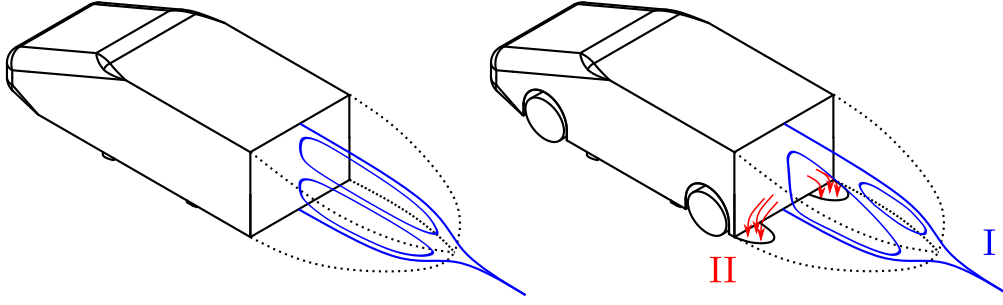

Figure 15: A conceptual sketch of the two flow mechanisms of wheel-vehicle interactions responsible for base drag variations. I: global variation of the vertical balance of the vehicle wake. II: mean mass exchange from the wake of the vehicle to the wakes of the wheels.

538 the present situation (II in figure 15). A constant mean mass flux extracted from the recirculation  
 539 region means that this mass flux has to continuously enter the recirculation region of the vehicle  
 540 wake and that the corresponding fluid particles have lost their mean longitudinal momentum. The  
 541 physical model proposed in Bao *et al.* (2022) is used in appendix B to link mass exchange and base  
 542 drag increase and to check the consistency of the measurements.

543 While these two mechanisms for wheel-vehicle interactions are of course coupled at the scale of  
 544 the vehicle, we insist on the fact that they do have to be distinguished because they imply different  
 545 physical processes. Moreover, for different initial states of the wake selected for example in section  
 546 5, it is interesting to figure out that the evolution with the wheel-to-base distance of the base drag  
 547 increase due to mean mass transfer is very similar in both situations – see insert in figure 13(a).  
 548 This means that the local characteristics of the wake of the wheels dominate this contribution to  
 549 the base drag.

550 In general, the physical mechanisms highlighted here provide some guidelines for the drag re-  
 551 duction of ground vehicles. For different vehicle geometries having different wake asymmetries,  
 552 reducing the wheel drag and minimizing the mean mass transfer are always favorable. However,  
 553 after any local changes at the scale of the wheels, one should search for the optimum wake balance  
 554 for this particular configuration. This can be obtained by modifying the angle of the rear spoiler or  
 555 the diffuser for example. Further experiments are on their way to study different vehicle geometries  
 556 and the role of interactions between the front and rear wheels.

557 **Acknowledgements.** The authors would like to warmly thank M. Grandemange from MFP Michelin and  
 558 Y.Haffner from CSTB for insightful discussions, J.-M. Breux for invaluable support during the experiments,  
 559 as well as F. Paillé, P. Braud and R. Bellanger for assistance with the PIV system.

560 **Funding.** The authors are deeply indebted for the support from MFP Michelin and the CPER Feder  
 561 programme Transport of Région Nouvelle-Aquitaine. D.B. wishes to acknowledge the support from China  
 562 Scholarship Council (CSC No. 201806260262).

563 **Declaration of interests.** The authors report no conflict of interest.

## 564 Appendix A. Effects of wheel state: rotating or stationary

565 In the present study, the wheel-vehicle interactions are investigated using rotating wheels. It is  
 566 important to question if the conclusions of the present study hold, at least qualitatively, for the  
 567 configuration with stationary wheels. By repeating the measurements presented in figure 3 but with  
 568 stationary wheels, we examine in figure 16 the effects of wheel state.

569 In figure 16(a), the effect of wheel state on the base drag is presented. The two different wheel  
 570 types, S and R, are considered. For different wheel-to-base distances  $l/w$ , the base drag increases  
 571 slightly for fixed wheels. The base drag increase is the same for all the  $l/w$  distances. In figure  
 572 16(b), the total drag  $\Delta\overline{C_D}$  is presented. For stationary cases, figure 16(c) shows  $\Delta\overline{C_D}(l/w) =$   
 573  $0.036 + \Delta\overline{C_B}(l/w)$ . The upward shift of  $\sim 0.036$  is bigger than  $\sim 0.024$  for the rotating wheels.

574 The insensitivity of the base drag to the wheel state is in accordance with the measurements

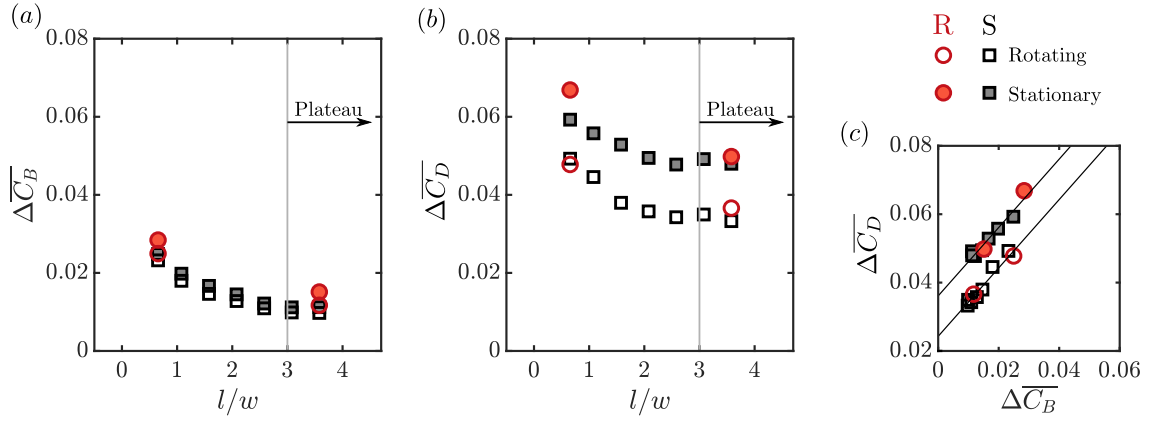

Figure 16: Evolution of (a) the base drag  $\Delta\overline{C}_B = \overline{C}_B - \overline{C}_{B0}$  and (b) total drag  $\Delta\overline{C}_D = \overline{C}_D - \overline{C}_{D0}$  of the body as a function of the wheel-to-base distance  $l/w$ . Different wheel shapes (sharp-edged-shoulder wheels (S, colored in black) or rounded-shoulder wheels (R, colored in red)) and different wheel states (rotating or stationary) are considered. The relationship between  $\Delta\overline{C}_D$  and  $\Delta\overline{C}_B$  is shown in (c).

575 in Pavia & Passmore (2017). Further investigation of the velocity measurements not shown here  
 576 for brevity confirms that the salient features of wheel-vehicle interactions derived from the rotating  
 577 cases can be gained in the same way by using the stationary cases. The main aspects of wheel-  
 578 vehicle interactions for this square-back body, namely the global forcing of the vehicle wake and the  
 579 local near-wake interactions, are therefore not related to the wheel state.

## 580 Appendix B. Evaluating the effect of mass exchange on the base drag

581 In Bao *et al.* (2022), a physical model based on a momentum balance of the wake was proposed to  
 582 link the mass exchange observed in their study and the concomitant base drag changes. This model  
 583 was derived from fundamental studies focusing on the effect of base suction on the base pressure of  
 584 either a 2-D D-shaped cylinder (Bearman, 1967) or a 3-D bluff body (Hsu *et al.*, 2021). In these  
 585 two reference works, a simple relation between the base drag change  $\Delta\overline{C}_B$  and the suction flow rate  
 586  $q$ :

$$\Delta\overline{C}_B = \frac{2q}{HWU_0} = 2C_q, \quad (9)$$

587 was found to hold for small suction flow rate coefficient  $C_q$  ( $C_q < 0.03$  in Hsu *et al.* (2021)). In  
 588 such situations, fluid particles continuously enter the mean recirculating region and therefore lose  
 589 their longitudinal momentum. By writing that a pressure decrease at the base is responsible for  
 590 this momentum flux balance, one gets  $\Delta F_x = (\rho q)U_0$ . Normalizing the corresponding quantities,  
 591 the simple relation  $\Delta\overline{C}_B = 2C_q$  is then obtained. This model was then found in Bao *et al.* (2022)  
 592 to be able to explain the results, such as the scalings for the base drag. Considering the overall  
 593 accordance of the present wheel situation with the obstacle situation, this model is now used to give  
 594 a global point-of-view linking the base drag variation and the local mass exchange observed in the  
 595 present study.

596 We start from the base drag evolution shown in figure 13. A gradual increase of  $\Delta\overline{C}_B^*$  of  $\sim 0.014$   
 597 from  $l/w = 3.09$  to  $l/w = 0.65$  is measured for all configurations. Accompanied by this, pressure  
 598 measurements show a continuous decrease of pressure and increase of periodic dynamics at the  
 599 bottom trailing edge of the vehicle with decreasing  $l/w$  at  $l/w < 3$ . Also, the mean properties in  
 600 the rear wheel wake are measured to be preserved for different  $l/w$  cases. As depicted in the sketches  
 601 in figure 17, we therefore assume a rectangular region with a length of  $3w$  downstream of the rear  
 602 wheels having the ability to induce mass exchange from the vehicle wake. With decreasing  $l/w$ , the  
 603 area of the mass exchange surface  $S_e = (3w - l)w$  increases linearly at  $l/w < 3$ . A space-averaged  
 604 mass transfer velocity  $U_e$  can be defined by  $q = 2S_e U_e$  (2 is here the number of rear wheels). Using  
 605 relation 9,  $U_e/U_0$  can be easily estimated with  $U_e/U_0 = HW\Delta\overline{C}_B^*/(4S_e)$  for all the cases in the

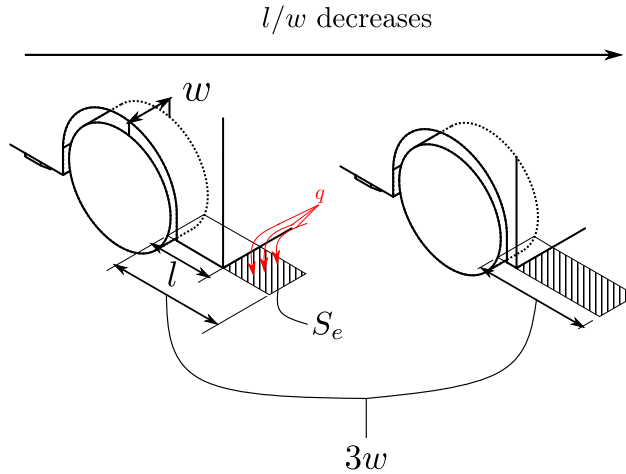

Figure 17: Schematics of the surface of mass exchange in the drag-sensitive regime  $l/w < 3$ .

606 drag-sensitive regime ( $l/w < 3$ ). For the cases with the shortest vehicle ( $l/w = 0.65$ ),  $U_e/U_0$  is found  
 607 to be  $\sim 0.055$ , which is a good order of magnitude of the downward vertical velocities measured  
 608 in figure 10(c) and 14(c, d) near  $z/H = G/H$ . The present experimental data is therefore in good  
 609 agreement with the physical model proposed in Bao *et al.* (2022).

## 610 References

- 611 AULTMAN, M., AUZA-GUTIERREZ, R., DISOTELL, K. & DUAN, L. 2022 Effects of wheel rotation  
 612 on long-period wake dynamics of the driver fastback model. *Fluids* **7** (1), 19.
- 613 BAO, D., BORÉE, J., HAFFNER, Y. & SICOT, C. 2022 Near wake interactions and drag increase  
 614 regimes for a square-back bluff body. *J. Fluid Mech.* **936**, A2.
- 615 BARROS, D., BORÉE, J., CADOT, O., SPOHN, A. & NOACK, B.R. 2017 Forcing symmetry  
 616 exchanges and flow reversals in turbulent wakes. *J. Fluid Mech.* **829**, R1.
- 617 BEARMAN, P.W. 1967 The effect of base bleed on the flow behind a two-dimensional model with a  
 618 blunt trailing edge. *Aeronaut. Q.* **18** (3), 207–224.
- 619 BONNAVION, G. & CADOT, O. 2018 Unstable wake dynamics of rectangular flat-backed bluff bodies  
 620 with inclination and ground proximity. *J. Fluid Mech.* **854**, 196–232.
- 621 BRADSHAW, P. 1973 Effects of streamline curvature on turbulent flow. *Tech. Rep.* Advisory Group  
 622 for Aerospace Research and Development Paris (France).
- 623 BRANDT, A., BERG, H., BOLZON, M. & JOSEFSSON, L. 2019 The effects of wheel design on  
 624 the aerodynamic drag of passenger vehicles. *Tech. Rep.* 2019-01-0662. Society of Automotive  
 625 Engineers, Inc.
- 626 COGOTTI, A. 1983 Aerodynamic characteristics of car wheel. *Int. J. of Vehicle Design* **SP3**.
- 627 CRONER, E., BÉZARD, H., SICOT, C. & MOTHAY, G. 2013 Aerodynamic characterization of the  
 628 wake of an isolated rolling wheel. *Int. J. Heat Fluid Flow* **43**, 233–243.
- 629 ELOFSSON, P. & BANNISTER, M. 2002 Drag reduction mechanisms due to moving ground and  
 630 wheel rotation in passenger cars. *Tech. Rep.* 2002-01-0531. Society of Automotive Engineers, Inc.
- 631 GRANDEMANGE, M., GOHLKE, M. & CADOT, O. 2013 Turbulent wake past a three-dimensional  
 632 blunt body. part 1. global modes and bi-stability. *J. Fluid Mech.* **722**, 51.
- 633 HAFFNER, Y., BORÉE, J., SPOHN, A. & CASTELAIN, T. 2020 Mechanics of bluff body drag  
 634 reduction during transient near-wake reversals. *J. Fluid Mech.* **894**, A14.

- 635 HAFFNER, Y., CASTELAIN, T., BORÉE, J. & SPOHN, A. 2021 Manipulation of three-dimensional  
636 asymmetries of a turbulent wake for drag reduction. *J. Fluid Mech.* **912**, A6.
- 637 HAFFNER, Y., LI, R., MELDI, M. & BORÉE, J. 2022 Drag reduction of a square-back bluff body  
638 under constant cross-wind conditions using asymmetric shear layer forcing. *Int. J. Heat Fluid  
639 Flow* **96**, 109003.
- 640 HEFT, A. I., INDINGER, T. & ADAMS, N. A. 2012 Introduction of a new realistic generic car model  
641 for aerodynamic investigations. *Tech. Rep.* 2012-01-0168. Society of Automotive Engineers, Inc.
- 642 HOBEIKA, T. & SEBBEN, S. 2018 Tyre pattern features and their effects on passenger vehicle drag.  
643 *Tech. Rep.* 2018-01-0710. Society of Automotive Engineers, Inc.
- 644 HOBEIKA, T., SEBBEN, S. & LANDSTROM, C. 2013 Investigation of the influence of tyre geometry  
645 on the aerodynamics of passenger cars. *Tech. Rep.* 2013-01-0955. Society of Automotive Engineers,  
646 Inc.
- 647 HSU, E.C., PASTUR, L., CADOT, O. & PAREZANOVIĆ, V. 2021 A fundamental link between steady  
648 asymmetry and separation length in the wake of a 3-d square-back body. *Exp. Fluids* **62** (5).
- 649 HUMINIC, A. & HUMINIC, G. 2017 Aerodynamic study of a generic car model with wheels and  
650 underbody diffuser. *Int. J. Automot. Technol.* **18** (3), 397–404.
- 651 JOSEFSSON, E., HOBEIKA, T. & SEBBEN, S. 2022a Evaluation of wind tunnel interference on  
652 numerical prediction of wheel aerodynamics. *J. Wind Eng. Ind. Aerodyn.* **224**, 104945.
- 653 JOSEFSSON, E., HOBEIKA, T., SEBBEN, S. & URQUHART, M. 2022b Investigation of tyre pattern  
654 effect on the aerodynamics of a passenger vehicle. *J. Fluids Eng.* **144** (11), 111209.
- 655 KRAJNOVIĆ, S. & DAVIDSON, L. 2005 Influence of floor motions in wind tunnels on the aerody-  
656 namics of road vehicles. *J. Wind Eng. Ind. Aerodyn.* **93** (9), 677–696.
- 657 KRAJNOVIĆ, S., SARMAST, S. & BASARA, B. 2011 Numerical investigation of the flow around a  
658 simplified wheel in a wheelhouse. *J. Fluids Eng.* **133** (11).
- 659 LANDSTRÖM, C., LÖFDAHL, L. & WALKER, T. 2009 Detailed flow studies in close proximity of  
660 rotating wheels on a passenger car. *Tech. Rep.* 2009-01-0778. Society of Automotive Engineers,  
661 Inc.
- 662 LANDSTRÖM, C., WALKER, T., CHRISTOFFERSEN, L. & LÖFDAHL, L. 2011 Influences of different  
663 front and rear wheel designs on aerodynamic drag of a sedan type passenger car. *Tech. Rep.*  
664 2011-01-0165. Society of Automotive Engineers, Inc.
- 665 LE GOOD, G.M., HOWELL, J.P., PASSMORE, M.A. & COGOTTI, A. 1998 A comparison of on-  
666 road aerodynamic drag measurements with wind tunnel data from pininfarina and mira. *Tech.*  
667 *Rep.* 980394. Society of Automotive Engineers, Inc.
- 668 LEGEAI, A. & CADOT, O. 2020 On the recirculating flow of three-dimensional asymmetric bluff  
669 bodies. *Exp. Fluids* **61** (12), 1–6.
- 670 LORITE-DÍEZ, M., JIMÉNEZ-GONZÁLEZ, J.I., PASTUR, L., MARTÍNEZ-BAZÁN, C. & CADOT, O.  
671 2020 Experimental analysis of the effect of local base blowing on three-dimensional wake modes.  
672 *J. Fluid Mech.* **883**.
- 673 MERCKER, E. & KNAPE, H.W. 1989 Ground simulation with moving belt and tangential blowing  
674 for full-scale automotive testing in a wind tunnel. *Tech. Rep.* 890367. Society of Automotive  
675 Engineers, Inc.

- 676 MLINARIC, P. & SEBBEN, S. 2008 Investigation of the influence of tyre deflection and tyre contact  
677 patch on cfd predictions of aerodynamic forces on a passenger car. In *7th MIRA International*  
678 *Vehicle Aerodynamics Conference*.
- 679 PATEL, D., GARMORY, A. & PASSMORE, M. 2022 On the wake of an isolated rotating wheel: An  
680 experimental and numerical investigation. *J. Wind Eng. Ind. Aerodyn.* **227**, 105049.
- 681 PAVIA, G. 2019 Characterisation of the unsteady wake of a square-back road vehicle. PhD thesis,  
682 Loughborough University.
- 683 PAVIA, G. & PASSMORE, M. 2017 Characterisation of wake bi-stability for a square-back geometry  
684 with rotating wheels. In *FKFS Conference*, pp. 93–109. Springer.
- 685 PAVIA, G., PASSMORE, M.A., VARNEY, M. & HODGSON, G. 2020 Salient three-dimensional  
686 features of the turbulent wake of a simplified square-back vehicle. *J. Fluid Mech.* **888**, A33.
- 687 PERRY, A. K. & PASSMORE, M. 2013 The impact of underbody roughness on rear wake structure  
688 of a squareback vehicle. *Tech. Rep.* 2013-01-0463. Society of Automotive Engineers, Inc.
- 689 REGERT, T. & LAJOS, T. 2007 Description of flow field in the wheelhouses of cars. *Int. J. Heat*  
690 *Fluid Flow* **28** (4), 616–629.
- 691 REISS, J., HAAG, L. & INDINGER, T. 2019 Cfd investigation on fully detailed and deformed car  
692 tires. *Int. J. Automot. Eng.* **10** (4), 324–331.
- 693 REJNIAK, A. A. & GATTO, A. 2021 Influence of rotating wheels and moving ground use on the  
694 unsteady wake of a small-scale road vehicle. *Flow Turbul. Combust.* **106** (1), 109–137.
- 695 SCHUETZ, T. 2016 *Aerodynamics of road vehicles*. Society of Automotive Engineers, Inc.
- 696 STRACHAN, R.K., KNOWLES, K. & LAWSON, N.J. 2007 The vortex structure behind an ahmed  
697 reference model in the presence of a moving ground plane. *Exp. Fluids* **42** (5), 659–669.
- 698 VARNEY, M. 2020 Base drag reduction for squareback road vehicles. PhD thesis, Loughborough  
699 University.
- 700 VARNEY, M., PASSMORE, M., SWAKEEN, R. & GAYLARD, A. 2020 Parametric study of reduced  
701 span side tapering on a simplified model with wheels. *Tech. Rep.* 2020-01-0680. Society of Auto-  
702 motive Engineers, Inc.
- 703 WANG, S., AVADIAR, T., THOMPSON, M. C. & BURTON, D. 2019 Effect of moving ground on the  
704 aerodynamics of a generic automotive model: The driver-estate. *J. Wind Eng. Ind. Aerodyn.*  
705 **195**, 104000.
- 706 WANG, Y. 2019 Experimental study of wheel-vehicle aerodynamic interactions. PhD thesis,  
707 Chasseneuil-du-Poitou, Ecole Nationale Supérieure de Mécanique et d’Aérotechnique.
- 708 WANG, Y., SICOT, C., BORÉE, J. & GRANDEMANGE, M. 2020 Experimental study of wheel-  
709 vehicle aerodynamic interactions. *J. Wind Eng. Ind. Aerodyn.* **198**, 104062.
- 710 WÄSCHLE, A. 2007 The influence of rotating wheels on vehicle aerodynamics-numerical and exper-  
711 imental investigations. *Tech. Rep.* 2007-01-0107. Society of Automotive Engineers, Inc.
- 712 WICKERN, G., ZWICKER, K. & PFADENHAUER, M. 1997 Rotating wheels-their impact on wind  
713 tunnel test techniques and on vehicle drag results. *Tech. Rep.* 970133. Society of Automotive  
714 Engineers, Inc.
- 715 WITTMIEIER, F., KUTHADA, T., WIDDECKE, N. & WIEDEMANN, J. 2014 Model scale based  
716 process for the development of aerodynamic tire characteristics. *Tech. Rep.* 2014-01-0585. Society  
717 of Automotive Engineers, Inc.

- 718 WITTMEIER, F., WIDDECKE, N., WIEDEMANN, J., LINDENER, N. & ARMBRUSTER, R.  
719 2013 Reifenentwicklung unter aerodynamischen aspekten. *ATZ-Automobiltechnische Zeitschrift*  
720 **115** (2), 144–150.
- 721 YU, X., JIA, Q., RASHIDI, M. M. & YANG, Z. 2020 Comprehensive investigating on the aerody-  
722 namic influences of the wheel contact patch. *J. Appl. Comput. Mech.* **6** (4), 934–955.
- 723 YU, X., JIA, Q. & YANG, Z. 2022 Comprehensive study of the aerodynamic influence of ground  
724 and wheel states on the notchback drivaer. *Energies* **15** (3), 1124.