



HAL
open science

Transient Modelling of Corrosion Protection Systems with BEM-Electrical Circuit Hybrid Model

Michaël Nale, Olivier Chadebec, Jean-Michel Guichon, Olivier Pinaud,
Brahim Ramdane, Virginie Roche, Marie Minola, Cédric Göeau, Bertrand
Bannwarth

► **To cite this version:**

Michaël Nale, Olivier Chadebec, Jean-Michel Guichon, Olivier Pinaud, Brahim Ramdane, et al..
Transient Modelling of Corrosion Protection Systems with BEM-Electrical Circuit Hybrid Model.
IEEE Transactions on Magnetics, 2023, 59 (5), 10.1109/TMAG.2023.3255979 . hal-04026218

HAL Id: hal-04026218

<https://hal.science/hal-04026218>

Submitted on 13 Mar 2023

HAL is a multi-disciplinary open access archive for the deposit and dissemination of scientific research documents, whether they are published or not. The documents may come from teaching and research institutions in France or abroad, or from public or private research centers.

L'archive ouverte pluridisciplinaire **HAL**, est destinée au dépôt et à la diffusion de documents scientifiques de niveau recherche, publiés ou non, émanant des établissements d'enseignement et de recherche français ou étrangers, des laboratoires publics ou privés.

Transient Modelling of Corrosion Protection Systems with BEM-Electrical Circuit Hybrid Model

Michaël Nale¹, Olivier Chadebec¹, Jean-Michel Guichon¹, Olivier Pinaud¹, Brahim Ramdane¹, Virginie Roche², Marie Minola², Cédric Göeau², Bertrand Bannwarth¹

¹Univ. Grenoble Alpes, CNRS, Grenoble INP, G2Elab, 38000 Grenoble, France

²Univ. Grenoble Alpes, CNRS, Grenoble INP, LEPMI, 38402 Saint Martin d'Hères, France

³DGA Techniques Navales, 29240 BREST

The modelling of corrosion protection systems in seawater is classically based on Boundary Element Method (BEM) and is generally limited to static studies. This paper presents an original transient approach coupling a BEM for the modelling of the seawater and a circuit representation approach in order to introduce nonlinear polarization laws and Impressed Current Cathodic Protection (ICCP) electric system. A special care is taken to the numerical implementation enabling the modelling of complex systems and interface phenomena.

Index words — Corrosion protection system modelling, Boundary Element Method (BEM), Equivalent circuit modelling.

I. INTRODUCTION

Recently, a new type of mine has emerged, based on the detection of the corrosion related electric signature produced by naval vessels. Two mechanisms are at stake. The first is the natural corrosion, the different parts of the ship being connected galvanically via the conductive seawater. The less noble material (mainly the hull made of carbon steel) corrodes in the presence of others materials (for instance NAB alloy of the propeller or Zinc of sacrificial anodes). Electric currents are so generated depending on the materials electrochemical polarization laws of the hull/water interface and on the resistance of the water. The second mechanism is due to the corrosion protection systems. In order to protect the hull, a solution is to inject electric current in the seawater that places the steel in its passivation domain. This corrosion protection system is called ICCP (Impressed Current Cathodic Protection) and also contributes to the electric signature of the ship (Fig. 1).

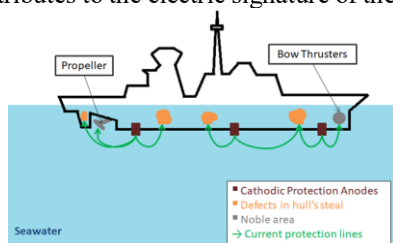

Fig. 1. Electrical field generated in seawater by a ship's hull under cathodic protection with the Impressed Current Cathodic Protection system ("ICCP").

The development of numerical tools to predict the electric signature of ships is an active research field [1],[2] and various modelling approaches has already been proposed. A classical assumption is to consider that the seawater has a homogenous conductivity and the phenomena have a sufficiently low frequency to neglect inductive and propagative effects. The problem is then considered static and consists in solving the Laplace equation in an unbounded domain. The Boundary

Element Method (BEM) is the most used because only the interface between water/hull has to be discretized [3]. Combined with the method of images to represent air/water and sea floor/water interfaces, it has shown excellent performances for complex geometries [4], [5].

However, aforementioned static BEM models are limited to model all the phenomena. Indeed, dynamic effects like the ICCP triggering or the influence of the moving propeller need to be taken into account. It is, therefore, important to develop transient approaches to be more realistic and to take into account the time dependency. To our knowledge, only few papers address this point. In [6], a transient modelling of ICCP systems has been proposed, but the approach is not transient, but rather multi-static. Recently, a transient BEM approach has been presented [7] but the application field and the associated assumptions are too far from the ICCP modelling.

In this paper, we propose a new approach to compute transient electric signatures due to the corrosion and the control of the ICCP systems. Compared to [6], the main advance is that our model can take into account the dynamic electrochemical phenomena located at the interface between the hull and the seawater. Moreover, our model has been thought to enable an easy integration of models that represent the corrosion at interfaces. Traditionally, electrochemists handle compact equivalent electrical networks including resistances and capacitances [8]. These equivalent circuits represent the local phenomenon at the interface and need to be coupled to a BEM in order to model the resistive behaviour of the conducting seawater. An original facet of this work is the implementation of this coupling. We will see in the following that it is possible to understand BEM as an electric circuit. Both approaches become compatible and can be efficiently hybridized and solved with powerful techniques dedicated to the resolution electromagnetic transient problems.

The paper is structured as follows. In a first part, we will present the classical BEM approach. In a second part, the hybridization method will be described. Finally, some numerical results will validate the method and will illustrate its efficiency.

II. BOUNDARY ELEMENT METHOD

Let us consider a conductive media Ω with a homogeneous conductivity σ ($S \cdot m^{-1}$) and delimited by its boundary S . The electric field derives from an electric scalar potential U (V) and is linked to the current density \mathbf{J} (A/m^2) by the Ohm's law. Considering the free-divergence of the current, we have:

$$\Delta U = 0 \quad (1)$$

Equation (1) needs to be completed by two boundary conditions on S :

- Neumann boundary condition where normal derivative of the current is imposed (ICCP and insulator).
- Robin boundary condition where the normal derivative of the potential is linked to the potential by a nonlinear law which represents electrochemical phenomena at the interface and which is known as polarization law.

Using the third Green's identity combined with a Galerkin's projection method, we get a linear matrix system linking both potential and its normal derivative on S . The surface S is meshed with N surface elements with 0-order piecewise functions that are used to interpolate both quantities. Thus, we have [3]:

$$\mathbf{H}U_{BEM} + \mathbf{T} \frac{\partial U_{BEM}}{\partial \mathbf{n}} = 0 \quad (2)$$

$$H_{ij} = \int_{S_i} \int_{S_j} \frac{\partial G}{\partial \mathbf{n}} dS_j dS_i \quad (i \neq j), \quad H_{ii} = \int_{S_j} \left(2\pi + \int_{S_i} \frac{\partial G}{\partial \mathbf{n}} dS_j \right) dS_i$$

$$T_{ij} = \int_{S_i} \int_{S_j} G dS_j dS_i$$

where \mathbf{n} is the outward normal of S , $G = 1/4\pi r$ is the standard 3D Green's function, S_i is the integration surface of element i , $\mathbf{H} \in \mathbb{R}^{N \times N}$, $\mathbf{T} \in \mathbb{R}^{N \times N}$, $U_{BEM} \in \mathbb{R}^N$ and $\frac{\partial U_{BEM}}{\partial \mathbf{n}} \in \mathbb{R}^N$.

J_{ni} is the normal current density associated to element i . It is linked to the normal derivative of the electric potential by:

$$J_{ni} = -\sigma \frac{\partial U_{BEMi}}{\partial \mathbf{n}} \quad (3)$$

The expression of the total current flowing through element i of surface S_i is then :

$$I_i = -\sigma s_i \frac{\partial U_{BEMi}}{\partial \mathbf{n}} \quad (4)$$

Let us notice that both \mathbf{H} and \mathbf{T} are fully dense. Classically, system (2) is solved with an iterative Newton-Raphson loop to deal with the nonlinear of the Robin condition [3].

III. BEM COUPLING WITH ELECTRIC CIRCUIT

A. Dynamic polarization law

The corrosion occurring at the interface between hull materials and water can be represented by a differential equation that links the current to the voltage jump at the interface. It is classical to represent it by an electric dipole which has the following topology (Fig. 2) [8].

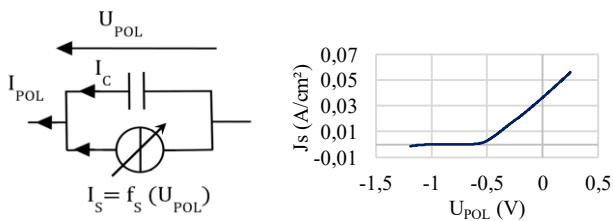

Fig. 2. Electric dipole modelling the corrosion phenomena at the interface between water and the hull (left). Typical static polarization curve of the steel $J_s = f_s(U_{pol})$ (right).

Let us define I_{POL} as the total current flowing through the interface and U_{pol} as the voltage jump between the water and the hull. We have:

$$I_{POL} = C \frac{\partial U_{POL}}{\partial t} + f_s(U_{pol}) \quad (5)$$

where C is a linear capacitance (constant and not depending on the polarization point), f_s is the static polarization law which is non-linear and t is the time. This model is classically obtained using an electrochemical cell that allows characterizing various material during laboratory tests.

B. Global electric circuit

The BEM model and the electric dipoles associated to corrosion are merged in a global electric circuit (Fig. 3). Region associated to Neumann boundary condition (imposed currents) can be seen as a current source with an unknown voltage U_I .

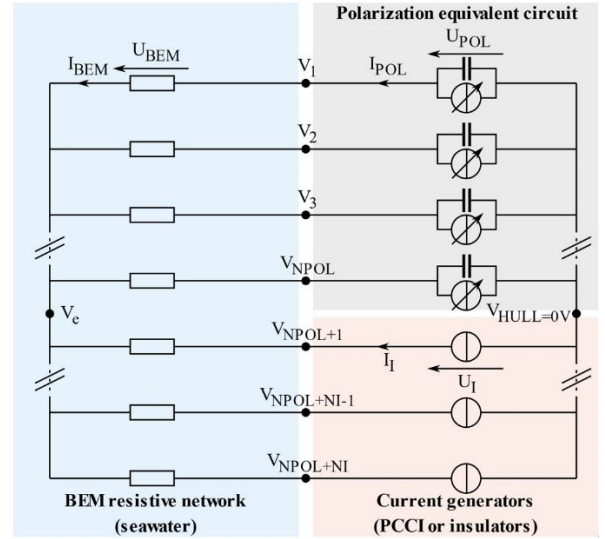

Fig. 3. Global equivalent electric circuit of the problem including polarized element and imposed current elements. Each branch of the circuit is associated to a surface element of the mesh.

The circuit is composed of $N = N_{POL} + N_I$ branches (associated to N_{POL} elements with the Robin conditions and N_I elements with Neumann boundary conditions) and $N+2$ electric nodes with potential V . The potential of the hull is the reference V and set to 0V. The BEM region can be seen as a network of resistances. An admittance matrix \mathbf{Y} , which links the currents to the boundary potentials, can be defined from (2) and (4).

$$\mathbf{Y} = -\sigma \mathbf{T}^{-1} \mathbf{H} \quad (6)$$

where s is a vector containing the element surfaces s_i .

C. State-space representation

The global electric circuit is solved in the time-domain with a nodal approach. It consists in writing a Kirchhoff's equation at each node. The state-space representation is governed by the following matrix system [8]:

$$\mathbf{E} \cdot \frac{dx}{dt} = \mathbf{A} \cdot x + \mathbf{B} \cdot u \quad (7)$$

with

$$\mathbf{E} = \begin{bmatrix} 0 & 0 & -\mathbf{M}_{POL}C \\ 0 & 0 & 0 \\ 0 & 0 & 0 \end{bmatrix} \quad \mathbf{A} = \begin{bmatrix} \mathbf{M}_{BEM} \mathbf{Y} \mathbf{M}_{BEM}^T & 0 & 0 \\ \mathbf{M}_I^T & \mathbf{Id}_I & 0 \\ \mathbf{M}_{POL}^T & 0 & \mathbf{Id}_{POL} \end{bmatrix}$$

$$x = \begin{bmatrix} V \\ U_I \\ U_{POL} \end{bmatrix} \quad \mathbf{B} = \begin{bmatrix} -\mathbf{M}_I & -\mathbf{M}_{POL} \\ 0 & 0 \\ 0 & 0 \end{bmatrix} \quad u = \begin{bmatrix} I_I \\ I_{POL} \end{bmatrix}$$

where V is a vector containing the electric potentials at nodes ($N+1$ values, N potentials for the meshed element + potential V_e). \mathbf{M}_{BEM} , \mathbf{M}_{POL} , \mathbf{M}_I are the incidence matrices linking the branches to the nodes of the electric circuit. \mathbf{M}_{BEM} is the incidence matrix associated to BEM circuit and \mathbf{M}_{POL} and \mathbf{M}_I are associated to polarized interfaces and current sources respectively. \mathbf{Id}_I and \mathbf{Id}_{POL} and is the identity matrix. \mathbf{C} is a diagonal matrix with the capacitance values of each polarization laws. $\mathbf{A}, \mathbf{E} \in \mathbb{R}^{(2N+1) \times (2N+1)}$, $\mathbf{B} \in \mathbb{R}^{(2N+1) \times N}$, $x \in \mathbb{R}^{2N+1}$, $u \in \mathbb{R}^N$. Let us notice that in (7), U_{POL} and I_{POL} are nonlinearly coupled by (5).

D. Time-stepping solving

To solve (7), the backward Euler method is used. The nonlinear problem is solved using the Newton-Raphson method with the vector quantity Res defined at each time step by:

$$Res(x_{i+1}) = \mathbf{E} \left(\frac{x_{i+1} - x_i}{\Delta t} \right) - \mathbf{A}x_{i+1} - \mathbf{B}u_{i+1} \quad (8)$$

where Δt is the time step and x_i is the solution at time step i . The derivative of Res versus x_{i+1} is:

$$\frac{\partial Res}{\partial x_{i+1}}(x_{i+1}) = \frac{1}{\Delta t} \mathbf{E} - \mathbf{A} - \mathbf{B} \frac{\partial u_{i+1}}{\partial x_{i+1}} \quad (9)$$

$$\mathbf{B} \frac{\partial u_{i+1}}{\partial x_{i+1}} = \begin{bmatrix} 0 & 0 & -\mathbf{M}_{POL} \frac{\partial f_s(U_{POL})}{\partial U_{POL}} \\ 0 & 0 & 0 \\ 0 & 0 & 0 \end{bmatrix}$$

This last term corresponds to the derivative of the static polarization law which can be computed numerically.

E. Final resolution technique

At each Newton-Raphson iteration, the linear system (7) could be solved directly by an LU decomposition. However, it is unrealistic in practice. We prefer to use a GMRES iterative solver based on the vector-product computation and compatible with compression techniques for BEM matrices [10]. So, to solve (8) requires the evaluation of the \mathbf{A} -vector product (\mathbf{E} -vector product being very fast to compute due to the sparsity of the matrix). Moreover, it must be pointed out that the building of admittance matrix \mathbf{Y} in \mathbf{A} requires the inversion of the fully dense matrix \mathbf{T} which is prohibitive. This is why we propose a two-steps solving process. The $\mathbf{T}^{-1} \mathbf{H} \mathbf{M}_{BEM}^T V$ product called ξ is first computed by solving the internal matrix system:

$$\mathbf{T} \xi = \mathbf{H} \mathbf{M}_{BEM}^T V \quad (10)$$

It consists in solving an internal matrix system at each GMRES iteration of the global resolution. The resolution time of this step can be speed-up thanks to the Hybrid-Cross Approximation (HCA) compression technique applied to \mathbf{H} and \mathbf{T} preventing the integration of dense matrix and avoiding a parabolic increase of the memory and the computation time [10]. The matrix-product is then very fast and an incomplete H-LU decomposition of \mathbf{T} matrix is used as a preconditioner to solve (10) in only few iterations.

The global system has also to be preconditioned. Considering that the static term is dominant in (7), an approximation of the inverse of the \mathbf{A} matrix is sought. A good option is to sort branches and nodes in order to make \mathbf{M}_{BEM} very close to the identity matrix. If the i -th electric node is associated with the i -

th branch, \mathbf{M}_{BEM} has $N+1$ row and N columns. The top $N \times N$ block is then a diagonal block scaled by -1 . The last row is composed only of 1 coefficient imposing a sum of current equal to zero for the V_e node. The $\mathbf{M}_{BEM} \mathbf{Y} \mathbf{M}_{BEM}^T$ vector product is then almost equivalent to $\tilde{\mathbf{Y}}$ -vector product which is almost equivalent to \mathbf{Y} -vector product except for the last row and the last column product. Let us consider the structure of \mathbf{A} :

$$\mathbf{A} = \begin{bmatrix} \tilde{\mathbf{Y}} & \mathbf{0} \\ \mathbf{M} & \mathbf{Id} \end{bmatrix}$$

Its approximated inverse can be lightly computed with the Schur complement method:

$$\mathbf{A}^{-1} \approx \begin{bmatrix} \mathbf{Z} & \mathbf{0} \\ -\mathbf{M}\mathbf{Z} & \mathbf{Id} \end{bmatrix}$$

\mathbf{Z} being the impedance matrix (i.e. the inverse of the admittance matrix). However, to express \mathbf{Z} is too expensive. A good option is to approximate \mathbf{Z} by:

$$\mathbf{Z} \approx -\text{diag}(\mathbf{H})^{-1} \mathbf{T} \sigma^{-1} s^{-1} \quad (11)$$

where $\text{diag}(\mathbf{H})^{-1}$ is a diagonal matrix containing the inverse of the diagonal coefficients of \mathbf{H} and s^{-1} contains the inverse of the surface of the elements of the mesh.

System (7) is solved and the x vector is obtained at each time step. Introducing the solution in the BEM model allows the computation of the electric field in the conductive media thanks to a classical post-processing [3].

IV. VALIDATION AND NUMERICAL EXAMPLE

We have tested our method on the following simplified problem: We consider a 1m side cube filled with water (5 S/m). The cube surface is meshed with 384 quadrangles. The cube is fed by two opposite faces. The interest of such a geometry is that the resistance can be calculated analytically (0.2Ω), the current path being perfectly straight. One electrode is associated to a static polarization curve of steel (Fig. 2) and a capacitance $C = 20$ F. The other electrode is associated to a current generator. Others faces of the cube are insulating. As all the electric parameters are known, it is also possible to simulate the problem with the circuit solver LTSpice. The scenario is the following. At $t=0$ s, we impose a current of $250 \mu\text{A}$ with the generator and switch it off after 30s. Comparison between LTSpice and the hybrid BEM solver are presented in Fig. 4., validating our model.

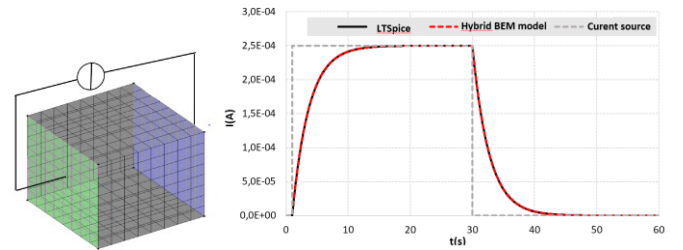

Fig. 4. Comparison of hybrid BEM and LTSpice models. Right : mesh and current source. Left : Imposed current (grey dotted). Current I_s flowing in the other electrode computed by LTSpice (black) and hybrid-BEM (red dotted).

In a second step, the method is tested in order to compute the varying signature of a ship model. This problem is schematized in Fig. 5 and consists in a volume of water with an immersed part of a ship. Four surface regions are considered. The ICCP region composed of two electrodes symmetrically located on each side and an insulating part which corresponds to the painted hull. The front of the hull and the propeller are respectively

associated to the polarization laws of uncovered steel and bronze.

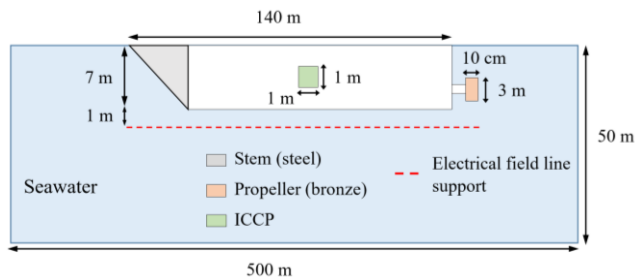

Fig. 5: Schematic representation of the studied case. The immersed front part is assimilated to an anode and the propeller to a cathode.

A transient simulation is carried out. The initial state consists in a galvanic coupling between the two materials (bronze and steel) through the seawater. At a given time, the ICCP is switched-on in order to protect the steel. The simulation aims to compute the modification of the electric anomaly generated by the corrosion protection system. Figure 6 presents the discretization of the problem.

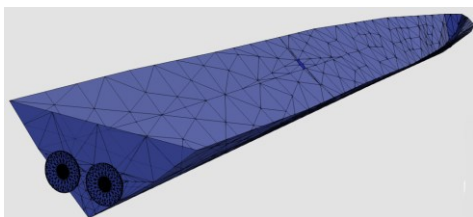

Fig. 6: Mesh of the model with 3712 elements. Air/water interface is taking into account with the method of images avoiding its mesh.

The initial condition corresponds to the equilibrium state defined by the polarization laws of both materials (duration of 4s). Then, at $t = 4s$, a current of 0.5 A/m^2 is injected by the ICCP electrode in order to protect the steel from corrosion. A new equilibrium is reached with a characteristic time of around 1s. Concerning the performance, 9 Newton Raphson iterations are needed for the initial static resolution (less for other resolutions because the last solution is taken as started point). Only very few GMRES iteration are needed for the resolution of the internal matrix system and about fifty for the global one leading to a good computation time. For this example, 200 time-steps have been computed in only 2500s.

It is also possible to study the time dependency of the electrical field computed on the support line presented in Fig. 5 just 1m under the ship. Figure 7 shows both signatures at $t = 0s$ and at $t = 10s$ after the ICCP has been triggered. For both cases, the general aspect of the signature is in agreement with the physic. We observe two peaks corresponding to both materials contribution on the signature. When the steel is protected, only the ICCP and bronze contribute to the signature. Figure 8 shows the temporal evolution of the electrical signature. When the ICCP is triggered, we find again the transition phase between the two equilibriums (with the same characteristic time of 1s). Let us notice that the electrical signature remains very important even if the ICCP protects the hull from corrosion.

V. CONCLUSION

In this paper, we proposed an original approach to solve transient problems of corrosion and cathodic protection. The hybridization of BEM and circuit-like representation allows a

time-stepping modelling. The numerical performance of the method is quite good thanks to the use of matrix compression techniques associated to efficient preconditioning approach. Let us notice that the approach is general and can be extended to other problems where the coupling between BEM and circuit representation is required.

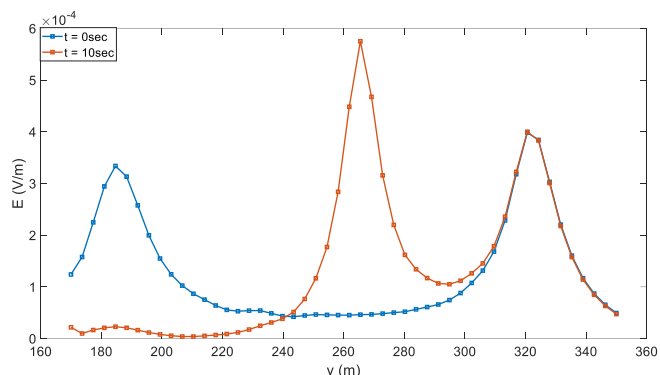

Fig. 7: Module of the electric field signature at $t=0s$ (natural corrosion) and $t=10s$ (steel passivated by a current injected in the ICCP).

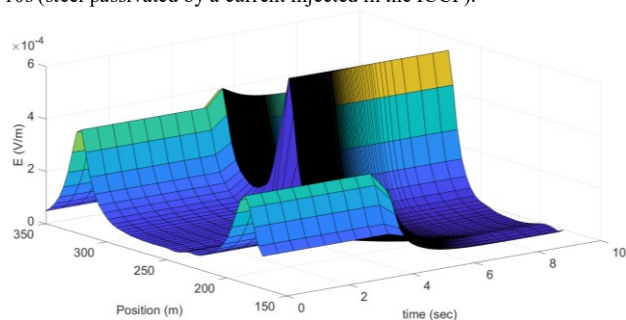

Fig. 8: Evolution of the electric signature computed on a line under the hull.

REFERENCES

- [1] H. Chung, C. Yang, G. Jeung, J. Jeon and D. Kim, "Accurate Prediction of Unknown Corrosion Currents Distributed on the Hull of a Naval Ship Utilizing Material Sensitivity Analysis," *IEEE Trans. on Magn.*, vol. 47, 5, 2011.
- [2] Y. S. Kim, S. K. Lee, H. J. Chung, J. G. Kim, "Influence of a simulated deep sea condition on the cathodic protection and electric field of an underwater vehicle", *Ocean Engineering*, 148, 2018.
- [3] D. T. Kalovelonis, D. C. Rodopoulos, T. V. Gortsas, D. Polyzos, S. V. Tsinopoulos, "Cathodic protection of a container ship using a detailed BEM model", *Journal of Marine Science and Engineering*, 8(5), 359, 2020.
- [4] D. C. Rodopoulos, T. V. Gortsas, S. V. Tsinopoulos, D. Polyzos, "ACA/BEM for solving large-scale cathodic protection problems. *Engineering Analysis with Boundary Elements*", 106, 2019
- [5] T. V. Gortsas, S. V. Tsinopoulos, D. Polyzos, "An accelerated boundary element method via cross approximation of integral kernels for large-scale cathodic protection problems", *Computer-Aided Civil and Infrastructure Engineering*, 37(7), 2022.
- [6] J. M. W. Baynham, R. A. Adey. "Simulating the transient response of ICCP control systems." *Modelling of Cathodic Protection Systems* 12, 45, 2005.
- [7] G.P. Pellizzer, E. D. Leonel. "Probabilistic corrosion time initiation modelling in reinforced concrete structures using the BEM." *Revista IBRACON de Estruturas e Materiais* 13, 2020.
- [8] V. Vivier, & M. E. Orazem, "Impedance analysis of electrochemical systems", *Chemical Reviews*, 122(12), 2022.
- [9] William H. Hayt, Jack E. Kemmerly, Steven Durbin, "Engineering Circuit Analysis", 1993, 5th edition, New York: McGraw Hill.
- [10] J. Siau, O. Chadebec, R. Perrussel and J. Poirier, "Hybrid Cross Approximation for a Magnetostatic Formulation," in *IEEE Trans. on Mag.*, vol. 51, no. 3, 2015.