



**HAL**  
open science

# Leveraging Unsupervised and Self-Supervised Learning for Video Anomaly Detection

Devashish Lohani, Carlos F Crispim-Junior, Quentin Barthélemy, Sarah Bertrand, Lionel Robinault, Laure Tougne

## ► To cite this version:

Devashish Lohani, Carlos F Crispim-Junior, Quentin Barthélemy, Sarah Bertrand, Lionel Robinault, et al.. Leveraging Unsupervised and Self-Supervised Learning for Video Anomaly Detection. 18th International Conference on Computer Vision Theory and Applications, Feb 2023, Lisbon, Portugal. pp.132-143, <10.5220/0011663600003417>. <hal-04026129>

**HAL Id: hal-04026129**

**<https://hal.science/hal-04026129v1>**

Submitted on 13 Nov 2023

**HAL** is a multi-disciplinary open access archive for the deposit and dissemination of scientific research documents, whether they are published or not. The documents may come from teaching and research institutions in France or abroad, or from public or private research centers.

L'archive ouverte pluridisciplinaire **HAL**, est destinée au dépôt et à la diffusion de documents scientifiques de niveau recherche, publiés ou non, émanant des établissements d'enseignement et de recherche français ou étrangers, des laboratoires publics ou privés.



HAL Authorization

# Leveraging Unsupervised and Self-Supervised Learning for Video Anomaly Detection

Devashish Lohani<sup>1,2</sup><sup>a</sup>, Carlos Crispim-Junior<sup>1</sup><sup>b</sup>, Quentin Barthélemy<sup>2</sup><sup>c</sup>, Sarah Bertrand<sup>2</sup>,  
Lionel Robinault<sup>1,2</sup><sup>d</sup> and Laure Tougne Rodet<sup>1</sup><sup>e</sup>

<sup>1</sup>Univ Lyon, Univ Lyon 2, CNRS, INSA Lyon, UCBL, LIRIS, UMR5205, F-69676 Bron, France

<sup>2</sup>Foxstream, F-69120 Vaulx-en-Velin, France

{devashish.lohani, carlos.crispim-junior, lionel.robinault, laure.tougne}@liris.cnrs.fr;  
{d.lohani, q.barthelemy, s.bertrand, l.robinault}@foxstream.fr

**Keywords:** Unusual event detection, Anomaly detection, Unsupervised learning, Self-supervised learning, Autoencoder

**Abstract:** Video anomaly detection consists of detecting abnormal events in videos. Since abnormal events are rare, anomaly detection methods are mainly not fully supervised. One such popular family of methods learn normality by training an autoencoder (AE) on normal data and detect anomalies as they deviate from this normality. But the powerful reconstruction capacity of AE makes it still difficult to separate anomalies from normality. To address this issue, some works enhance the AE with an external memory bank or attention modules but still these methods suffer in detecting diverse spatial and temporal anomalies. In this work, we propose a method that leverages unsupervised and self-supervised learning on a single AE. The AE is trained in an end-to-end manner and jointly learns to discriminate anomalies using three chosen tasks: (i) unsupervised video clip reconstruction; (ii) unsupervised future frame prediction; (iii) self-supervised playback rate prediction. Furthermore, to correctly emphasize the detected anomalous regions in the video, we introduce a new error measure, called the blur pooled error. Our experiments reveal that the chosen tasks enrich the representational capability of the autoencoder to detect anomalous events in videos. Results demonstrate our approach outperforms the state-of-the-art methods on three public video anomaly datasets.

## 1 INTRODUCTION

Since past few years, the task of video anomaly detection (VAD) has attained a major attention in the computer vision research (Li et al., 2013; Lu et al., 2013; Kiran et al., 2018; Ramachandra et al., 2022). Indeed, this task is interesting as well as challenging since it requires in depth comprehension of space-time features in order to distinguish anomalous events from normal events in the video. The anomalous events are the ones which do not conform with the largely present normal events, *i.e.*, they are rare. Due to this, we do not know in advance what kinds of abnormal events may appear in the video as they depend on the context. For example, for a site where only pedestrians are authorized, all the vehicles are anomalies

but for another site where pedestrians and bicycles are allowed, vehicles except bicycles are anomalies. Similarly, on one site all abrupt movements like running, chasing, brawling, *etc.* are abnormal while for another site running is considered normal. All these points require the development of approaches which can generalize on different contexts without labelled data.

One of the most highly successful approaches to tackle this problem is to use a deep convolutional autoencoder (AE) with proxy tasks such as frame reconstruction or frame prediction (Hasan et al., 2016; Luo et al., 2017; Zhao et al., 2017; Chang et al., 2020; Ramachandra et al., 2022). Furthermore, AE based approaches often have the least assumptions on data. The basic idea of using an AE is to learn normality from training data in order to detect anomalous events while testing. But many works have shown that the strong reconstruction capacity of the autoencoder makes it still difficult to distinguish anomalous events from normal events (Gong et al., 2019; Astrid et al., 2021a; Lv et al., 2021a; Szymanowicz et al., 2022).

<sup>a</sup> <https://orcid.org/0000-0003-2666-7586>

<sup>b</sup> <https://orcid.org/0000-0002-5577-5335>

<sup>c</sup> <https://orcid.org/0000-0002-7059-6028>

<sup>d</sup> <https://orcid.org/0000-0003-0933-2485>

<sup>e</sup> <https://orcid.org/0000-0001-9208-6275>

Many works have addressed this problem by attaching different functionalities to the AE like memory modules (Gong et al., 2019; Park et al., 2020; Liu et al., 2021b), attention modules (Lv et al., 2021a), pseudo anomalies (Astrid et al., 2021a; Astrid et al., 2021b), optical flow (Liu et al., 2018; Liu et al., 2021b; Cho et al., 2022), clustering (Chang et al., 2020), *etc.* But all these works still struggle to detect diverse spatial and temporal anomalies, especially in challenging datasets with multiple scenes such as the ShanghaiTech dataset (Luo et al., 2017). External supervision can also be added to all the above approaches, *e.g.*, using a pre-trained network for first detecting objects of interest and later employing an unsupervised pipeline (with or without AE) to detect anomalies (Yu et al., 2020; Georgescu et al., 2021a; Georgescu et al., 2021b; Liu et al., 2021b). The main problem with these approaches is that they assume all abnormal object classes are known, *i.e.*, they will fail to detect an anomaly if it belongs to an object class unknown to the object detector. Furthermore, their capability to detect anomalies directly depend on the object detector and external dataset used to train it.

In this work, we proceed with the AE based approaches, proposing a method that leverages unsupervised and self-supervised learning on a single AE. To this end, we devise multiple tasks to enhance the normal spatio-temporal understanding of the AE by training it only on the normal data. Each task has its specific objective: (i) video clip reconstruction (VCR) to learn spatio-temporal characteristics of the normal videos; (ii) future frame prediction (FFP) to learn how normal spatio-temporal patterns propagate along the videos; (iii) playback rate prediction (PRP) to strengthen the playback speed perception of the encoder.

PRP task is popular in self-supervised representation learning and is used for downstream supervised tasks like action recognition and video retrieval (Benaim et al., 2020; Wang et al., 2020a; Yao et al., 2020). We carefully adapt this task for VAD with the motivation to detect anomalies caused by abrupt motion. To our knowledge, it is the first time PRP has been used for VAD and our experiments demonstrate its effectiveness. Our method is end-to-end trainable and is jointly trained on the three tasks. While testing, the anomaly is detected as the combined anomaly score of the three tasks is higher for anomalous frames.

Most of the current methods use mean squared error (MSE) or peak signal to noise ratio (PSNR) for the error measure between input and reconstructed frames (Zhao et al., 2017; Gong et al., 2019; Park et al., 2020; Astrid et al., 2021a; Astrid et al., 2021b;

Lv et al., 2021a). These measures integrate errors on the whole image and are prone to noise (Sinha and Russell, 2011; Gudi et al., 2022). Recently, the proximally sensitive error (PSE) remove incoherent noise to better localize and thus detect anomalies (Gudi et al., 2022). We take it further a step and introduce a new measure, called the blur pooled error (BPE). It is locally sensitive and keeps only relevant pixels for error calculation. Most VAD works apply a min-max rescaling to anomaly scores per video (Liu et al., 2018; Gong et al., 2019; Park et al., 2020; Astrid et al., 2021a; Astrid et al., 2021b). It is sensitive to extreme values and to address this issue, we propose a robust rescaling of scores.

Our main contributions are as follows:

- A method that leverages unsupervised and self-supervised learning on a single AE, end-to-end trained with chosen tasks: (i) video clip reconstruction; (ii) future frame prediction; (iii) playback rate prediction.
- We introduce the blur pooled error (BPE), a locally sensitive measure that helps to correctly detect the anomalous parts in the downsampled video.
- We introduce a robust rescaling of anomaly score, which is less sensitive to extreme values
- We conduct extensive experiments on three public datasets, showing superior results to state-of-the-art.

For research reproducibility, code is available here: [https://github.com/devashishlohani/luss-ae\\_vad](https://github.com/devashishlohani/luss-ae_vad).

The article is organized as follows: Section 2 highlights related works, Section 3 describes details of our method, Sections 4 and 5 present experiments and results for different works, and Section 6 concludes this paper.

## 2 RELATED WORKS

VAD approaches are often not fully supervised due to lack of anomaly examples. There are two common VAD settings: unsupervised learning where only the normal training data is used (Li et al., 2013; Lu et al., 2013; Luo et al., 2017), and weakly supervised learning where the video-level annotations are used (Feng et al., 2021; Lv et al., 2021b; Tian et al., 2021). We focus on the unsupervised learning as it is a more practical setting which can be deployed in the site without any requirement of annotations. Due to availability of only single class (normal) data during training, the classical two-class supervised classifier cannot be used to detect anomalies. Thus, the VAD task

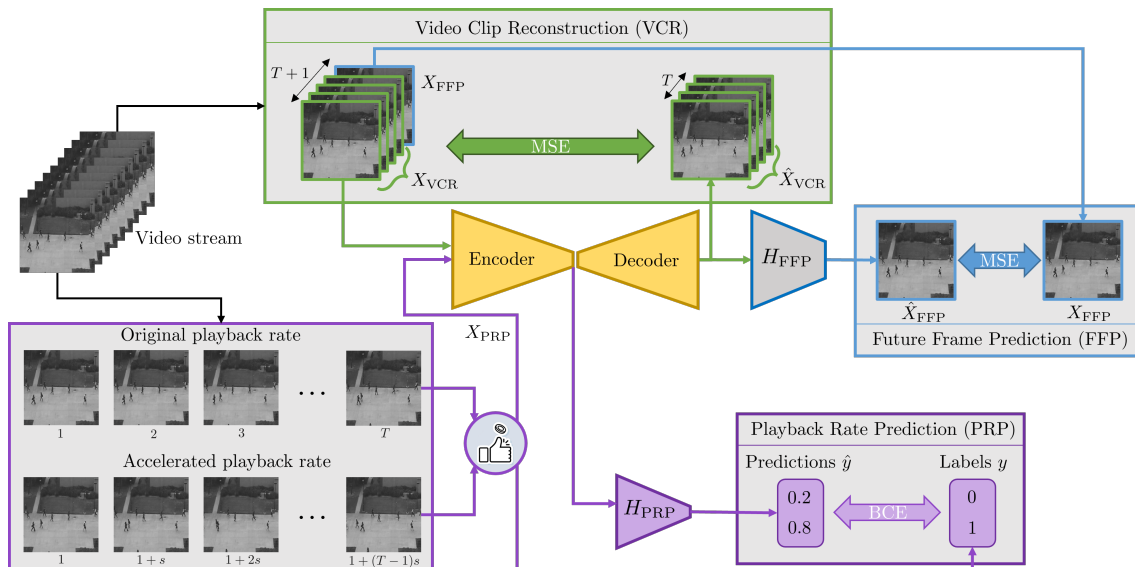

Figure 1: Overall schema of the proposed LUSS-AE method. A window of  $T$  consecutive frames is passed into the autoencoder, which reconstructs this window, followed by  $H_{FFP}$  head which predicts the future  $(T + 1)^{th}$  frame. Another window of  $T$  frames with original or accelerated playback rate is passed through the encoder and  $H_{PRP}$  head to predict the playback rate in the self-supervised way.

is indirectly addressed using proxy tasks like video clip / frame reconstruction (Hasan et al., 2016; Gong et al., 2019; Liu et al., 2021b), frame prediction (Liu et al., 2018; Park et al., 2022), self-supervised tasks (Yu et al., 2020; Georgescu et al., 2021a), *etc.* The principal learning component is often an autoencoder (Hasan et al., 2016; Luo et al., 2017; Ramachandra et al., 2022), or an adversarial network (Liu et al., 2018; Ye et al., 2019).

In the last few years, we have seen a massive application of AEs for VAD (Kiran et al., 2018; Ramachandra et al., 2022). They are used in future frame prediction (Liu et al., 2018; Park et al., 2022) or video clip / frame reconstruction task (Hasan et al., 2016; Zhao et al., 2017). These approaches use the powerful representational capacity of the AE to learn normal features while training and detect anomalies as they deviate from these features. The problem is that the AE even reconstruct the abnormal frames well, making it difficult to separate them from normal frames (Gong et al., 2019; Astrid et al., 2021a; Szymanowicz et al., 2022). Many methods address this issue: (Gong et al., 2019) and (Park et al., 2020) use memory modules to memorize normal patterns, (Lv et al., 2021a) uses attention prototypes to encode normal dynamics, (Astrid et al., 2021a; Astrid et al., 2021b) uses pseudo anomalies to enrich encoder, *etc.* Still all these works fail to detect diverse spatio-temporal anomalies as they AE do not capture all the important and pertinent normal features.

Some works add an external supervision to the

VAD pipeline, often using a pre-trained object detector or feature extractor. The object detector detects all objects of interest in the video, which are later fed to a VAD pipeline. Also known as object-centric methods (Ionescu et al., 2019; Georgescu et al., 2021a; Liu et al., 2021b), they assume that all possible object classes are known *a priori*, and that datasets used to train object detectors contain all these objects, which is strong limitation for generalization. Furthermore, omission or false detection of objects can also lead to failure of VAD. Similarly, works that use a pre-trained feature extractor (Wang et al., 2020b) have same problems and are also biased towards external dataset where features were learned.

Nowadays, self-supervised learning is used in many applications (Liu et al., 2021a). It uses self-supervisory signals from the data itself and does not require external annotations. It is often used as a pre-training step to enrich a learning module, which is later used for downstream tasks like video classification, detection, *etc.* (Yao et al., 2020). Concerning VAD, a recent work uses several self-supervised tasks to jointly train a 3DCNN to detect anomalies (Georgescu et al., 2021a). It has promising results but relies on an external supervision via a pre-trained YOLOv3 detector.

In this work, we propose a approach without any external supervision, using unsupervised and self-supervised learning to jointly train an AE for VAD. We use three tasks, two common unsupervised VAD tasks: video clip reconstruction (VCR), future frame

prediction (FFP) and a new task called the playback rate prediction (PRP). The PRP task, often used in self-supervised learning, deals with understanding the playback rate of a video (Benaim et al., 2020; Wang et al., 2020a; Yao et al., 2020). We carefully accommodate this task for VAD, with the objective to detect abrupt motion based anomalies by reinforcing the speed understanding of the encoder. Overall, our method is end-to-end trainable and can be applied on any AE.

### 3 METHOD

In this section, we present our proposed LUSS-AE (Leveraging Unsupervised and Self-Supervised AutoEncoder) method, illustrated in Figure 1. The main idea is to learn normal spatio-temporal features in order to detect anomalies. To this end, we propose to train a 3D convolutional autoencoder (3DCAE) on normal videos using carefully designed tasks in a unsupervised or self-supervised manner. The video clip reconstruction task learns spatio-temporal characteristics of normal videos. The future frame prediction task is designed to learn the propagation of spatio-temporal patterns in the normal videos. Finally, the playback rate prediction task strengthens the speed understanding of the encoder. The autoencoder is jointly trained on all these tasks. During testing, each of these branches provides a score to distinguish anomalous frames from non-anomalous ones.

#### 3.1 Learning normality using multiple tasks

In this subsection, we explain how the proposed tasks help in learning normal characteristics during training. We describe each task with its role, followed by details on how all these tasks are trained in a joint and end-to-end manner.

Before defining the tasks, we define the video clip. Given a video with  $n$  frames  $\{I_1, I_2, \dots, I_n\}$ , a video clip  $V$  of length  $l$  and temporal gap  $s$  between frames is defined as:

$$V_{l,s} = \{I_1, I_{1+s}, \dots, I_{1+(l-1)s}\} = \{I_{1+ts}\}_{0 \leq t < l}, \quad (1)$$

where for simplicity, we assume clip starts from 1<sup>st</sup> frame.

##### 3.1.1 Video Clip Reconstruction (VCR)

Reconstructing a video clip is one of the most popular tasks for unsupervised VAD (Zhao et al., 2017; Gong et al., 2019; Astrid et al., 2021a; Astrid et al.,

2021b; Liu et al., 2021b). It aims to reconstruct an input video clip using an AE type network. The AE is trained only on normal video clips with the learning objective of minimizing the MSE between the input and reconstructed clips. The main hypothesis is that the abnormal clips will be badly reconstructed during testing.

Using Eq. (1), a non-strided video clip of length  $T + 1$  frames can be defined as:

$$V_{T+1,1} = \{I_1, I_2, \dots, I_T, I_{T+1}\}. \quad (2)$$

The first  $T$  frames of this clip is used for the VCR task and we denote it as  $X_{\text{VCR}}$ , *i.e.*,  $X_{\text{VCR}} = \{I_1, I_2, \dots, I_T\}$ . This video clip goes through the autoencoder followed by an activation function to produce a reconstructed clip as  $\hat{X}_{\text{VCR}} = \tanh(\text{Dec}(\text{Enc}(X_{\text{VCR}})))$ , where Enc and Dec stand for encoder and decoder networks respectively. The loss function can then be defined as:

$$\mathcal{L}_{\text{VCR}} = \frac{1}{T \times C \times H \times W} \|\hat{X}_{\text{VCR}} - X_{\text{VCR}}\|_F^2, \quad (3)$$

where  $C$ ,  $H$  and  $W$  denotes channels, height and width of each frame and  $\|\cdot\|_F$  denotes the Frobenius norm.

##### 3.1.2 Future Frame Prediction (FFP)

Predicting a future frame is also a well-spread task for unsupervised VAD (Liu et al., 2018; Park et al., 2020; Liu et al., 2021b; Lv et al., 2021a). It aims to predict an unseen future frame, given an input video clip. This requires comprehension of how normal spatio-temporal patterns propagate along the video clip. Similar to VCR task, the objective is to minimize the MSE between the predicted and actual future frame. Since the AE is trained only on normal videos, it should predict the anomalous frames incorrectly.

This task uses the same input of VCR task, *i.e.*,  $X_{\text{VCR}}$ . After passing through the AE, the video clip  $X_{\text{VCR}}$  goes through the prediction head  $H_{\text{FFP}}$  to predict the future frame as  $\hat{X}_{\text{FFP}} = H_{\text{FFP}}(\text{Dec}(\text{Enc}(X_{\text{VCR}})))$ . This frame is compared with the actual future frame, *i.e.*, frame  $T + 1$  of  $V_{T+1,1}$  (see Eq. (2)) denoted as  $X_{\text{FFP}}$ , where  $X_{\text{FFP}} = I_{T+1}$ . The loss function is then defined as:

$$\mathcal{L}_{\text{FFP}} = \frac{1}{C \times H \times W} \|\hat{X}_{\text{FFP}} - X_{\text{FFP}}\|_F^2. \quad (4)$$

##### 3.1.3 Self-supervised Playback Rate Prediction (PRP)

The PRP task in self-supervised representation learning is used as a pretext task to learn transferable semantic spatio-temporal features for downstream tasks like action recognition (Benaim et al., 2020; Wang

et al., 2020a; Yao et al., 2020). In other words, first PRP task is performed and later the learned model is adapted to downstream tasks. Contrary to them, we perform the PRP task on a single AE with two other tasks, all done simultaneously in a joint and end to end manner.

The original PRP task generates speed labels for video clip sampled at different rates and aims at predicting them (Benaim et al., 2020; Wang et al., 2020a; Yao et al., 2020). Since we know that the training videos in VAD are normal, we adapt this task to generate two speed-rate labels: original playback rate (implying normal behaviour) and accelerated playback rate with 2x to 5x speed (implying abnormal behaviour). The motive is to enforce the encoder with motion comprehension of normal videos. During testing, we hypothesize that the encoder would detect anomalies caused by irregular and abrupt motion.

Concretely, given a video clip, this task aims to predict its playback rate. The clip with default playback rate of the video is termed as the original playback rate clip and the clip formed by skipping 1 (2x), 2 (3x), 3 (4x) or 4 (5x) frames is designated as an accelerated playback rate clip. The input  $X_{\text{PRP}}$  is a video clip of length  $T$ , chosen between an original playback rate (class  $c = 1$ ) and an accelerated playback rate (class  $c = 2$ ) with equal chance (50% probability each):

$$X_{\text{PRP}} = \begin{cases} V_{T,1} & \text{when } c = 1 \\ V_{T,s \in \{2,3,4,5\}} & \text{when } c = 2 \end{cases}, \quad (5)$$

where the accelerated playback rate clip, when  $c = 2$ , is a temporally strided video clip with temporal gap  $s$  randomly chosen between 2 and 5. The loss function for this classification task is the binary cross-entropy (BCE), defined as:

$$\mathcal{L}_{\text{PRP}} = - \sum_{c=1,2} y[c] \log(\hat{y}[c]), \quad (6)$$

where  $\hat{y} = \text{softmax}(H_{\text{PRP}}(\text{Enc}(X_{\text{PRP}}))) \in \mathbb{R}^2$ ,  $H_{\text{PRP}}$  is the playback rate prediction head and  $y$  is the one-hot encoding of the ground-truth classes for  $X_{\text{PRP}}$ .

### 3.1.4 Training objective

A single autoencoder is trained with the above mentioned tasks in a joint and end-to-end manner. The overall training loss is defined as the weighted sum of individual loss functions:

$$\mathcal{L} = \lambda_1 \mathcal{L}_{\text{VCR}} + \lambda_2 \mathcal{L}_{\text{FFP}} + \lambda_3 \mathcal{L}_{\text{PRP}}, \quad (7)$$

where  $\lambda_1$ ,  $\lambda_2$  and  $\lambda_3$  are the weights in  $(0, 1]$  that regulate the importance of each task. The sum of these weights is not necessarily 1, even though we

could regularize them such that the sum is always one. Since it just the matter of regularization, the overall impact of weights remains the same.

## 3.2 Detecting anomaly

In this subsection, we describe how the video anomalies are detected during testing. Given a test video clip, each of the three tasks provides an anomaly score and if the weighted sum of these scores is above a threshold, it is flagged as an anomaly, as illustrated in Figure 2. We first define below some image or video error measures and then how these measures help to calculate the final anomaly score.

### 3.2.1 Image error measures

To quantitatively assess how well a future frame is predicted or how well a video clip is reconstructed, we need to compare them with the appropriate ground truth using some error measures. The most widely used measure in the domain of VAD is MSE (Zhao et al., 2017; Liu et al., 2018; Gong et al., 2019; Lv et al., 2021a). Given two images  $J, \hat{J} \in \mathbb{R}^{H \times W \times C}$ , the MSE is calculated as:

$$\text{MSE}(J, \hat{J}) = \frac{1}{C \times H \times W} \|\hat{J} - J\|_F^2. \quad (8)$$

Since last few years, many VAD works use the peak signal to noise ratio (PSNR) measure (Ye et al., 2019; Astrid et al., 2021a; Astrid et al., 2021b; Park et al., 2022). But PSNR also depends on MSE as can be seen in its mathematical formulation. Both MSE and PSNR integrate errors on the whole image and therefore are prone to random and incoherent noise (Sinha and Russell, 2011; Gudi et al., 2022). To overcome this, a new measure called the proximally sensitive error (PSE) is proposed by (Gudi et al., 2022). It is defined as:

$$\text{PSE}(J, \hat{J}) = \frac{1}{C \times H \times W} \|(\hat{J} - J) * G_{(\sigma,k)}\|_F^2, \quad (9)$$

where  $*$  is the convolution operator and  $G_{(\sigma,k)}$  is a 2D Gaussian kernel with size  $k$  and standard deviation  $\sigma$ , given by:

$$G_{(\sigma,k)}[i, j] = \frac{1}{2\pi\sigma^2} e^{-\frac{i^2+j^2}{2\sigma^2}}, \quad (10)$$

where  $i$  and  $j$  are the pixel coordinates centered in the kernel. Note, the kernel size has a direct relation with standard deviation as  $k = 6\sigma - 1$ . Thanks to the Gaussian convolution, PSE smooths incoherent noise and is locally sensitive. However, an anomaly generating an important error in some pixels can disappear in the noise of all other pixels of the high-dimensional image.

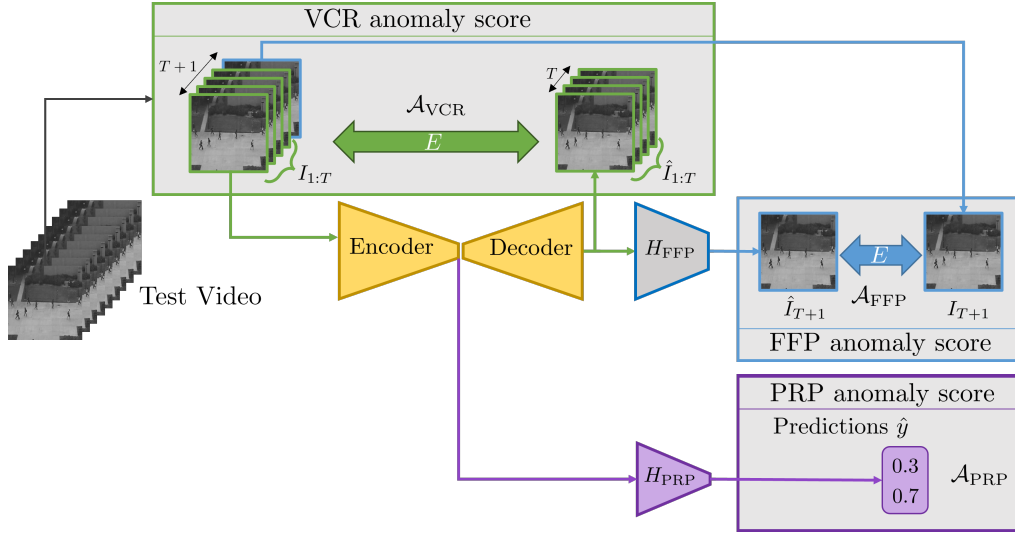

Figure 2: Overall schema of the proposed LUSS-AE method during testing. A window of  $T + 1$  consecutive frames is drawn sequentially from the test video. The first  $T$  frames from this window is the input to the system and the output for each task is computed on it. The anomaly score is determined for each task, i.e.,  $\mathcal{A}_{VCR}$ ,  $\mathcal{A}_{FFP}$  and  $\mathcal{A}_{PRP}$ , and the final anomaly score is their weighted sum.

In this article, we take this idea one step further and introduce the blur pooled error (BPE), defined as:

$$\text{BPE}(J, \hat{J}) = \frac{1}{C \times H \times W} \|S_b((\hat{J} - J) * B_k)\|_F^2, \quad (11)$$

where  $B_k$  is a generic 2D low-pass filter with kernel size  $k$ , and  $S_b$  signifies a subsampling with stride  $b$  (Zhang, 2019). Using a low-pass filter smooths incoherent noise, like PSE, then subsampling keeps only the most pertinent values from the input, increasing sensitivity to anomalies. All these measures can easily be extended to video clip by applying them to each frame.

### 3.2.2 Anomaly score and rescaling

During testing, a non-strided video clip of  $T + 1$  frames is used. The anomaly score for frame  $T + 1$  is composed of three parts, one for each task.

(i) The VCR anomaly score is defined as:

$$\mathcal{A}_{VCR} = \frac{1}{T} \sum_{t=1}^T E(\hat{I}_t, I_t), \quad (12)$$

where  $I_t$ ,  $\hat{I}_t$  are the  $t^{\text{th}}$  frame and its reconstruction, and  $E$  can be one of MSE, PSE or BPE.

(ii) The FFP anomaly score is defined as:

$$\mathcal{A}_{FFP} = E(\hat{I}_{T+1}, I_{T+1}). \quad (13)$$

(iii) The PRP anomaly score is defined as the probability of accelerated class ( $c = 2$ ):

$$\mathcal{A}_{PRP} = \hat{y}[2], \quad (14)$$

where  $\hat{y}$  is the output of PRP branch as defined in Eq. (6).

The final anomaly score is defined as:

$$\mathcal{A} = \alpha_1 \mathcal{A}_{VCR} + \alpha_2 \mathcal{A}_{FFP} + \alpha_3 \mathcal{A}_{PRP}, \quad (15)$$

where  $\alpha_1, \alpha_2, \alpha_3$  are the weights in  $[0, 1]$  for the three scores. Even though these weights have similar functioning like  $\lambda$  weights of training, they do not have a direct relationship with them. This is because the  $\mathcal{A}$  and  $\mathcal{L}$  values are different. While  $\mathcal{A}_{VCR}$  and  $\mathcal{A}_{FFP}$  can also use PSE and BPE, their counterpart in  $\mathcal{L}$  use only MSE. Besides,  $\mathcal{A}_{PRP}$  is the softmax value, while  $\mathcal{L}_{PRP}$  is a binary cross-entropy value.

Most VAD works apply a min-max rescaling to scores per video (Liu et al., 2018; Gong et al., 2019; Park et al., 2020; Astrid et al., 2021a; Astrid et al., 2021b). This scaling bounds values to interval  $[0, 1]$  where the minimum and maximum values are forced to be 0 and 1 respectively. Due to this, it is prone to outliers with extreme values. To address this issue, we propose a robust rescaling per video. For a test video with  $n$  frames, the rescaled anomaly score for frame  $t$  is defined as:

$$\tilde{\mathcal{A}}_t = \frac{\mathcal{A}_t - \text{med}(\{\mathcal{A}_i\})}{\text{iqr}_{1-99}(\{\mathcal{A}_i\})}, \quad (16)$$

where  $\text{med}(\cdot)$  and  $\text{iqr}_{1-99}(\cdot)$  are respectively the median and the interquartile range (between 1<sup>st</sup> and 99<sup>th</sup> percentiles) of scores  $\{\mathcal{A}_i\}_{i=1}^n$ . Finally, like previous methods, the higher scores correspond to anomalies.

## 4 EXPERIMENTS

### 4.1 Datasets

We perform experiments on three publicly available benchmark datasets: UCSD Ped2 (Li et al., 2013), CUHK Avenue (Lu et al., 2013), and ShanghaiTech (Luo et al., 2017). Each dataset has a standard training / test division, where the training set consists of only normal videos while testing set has videos with one or more anomalous events.

**UCSD Ped2.** This dataset consists of 16 training and 12 test videos with 12 anomalous events, where normal videos include walking pedestrians and anomalies include bikes, carts, or skateboards (Li et al., 2013).

**CUHK Avenue.** It contains 16 training and 21 test videos with 47 anomalous events, where anomalies include objects such as bikes or human actions such as unusual walking directions, running, or throwing stuff (Lu et al., 2013).

**ShanghaiTech.** It contains 330 training and 107 test videos with total of 130 anomalous events. Unlike the previous two datasets, this dataset is multi-view with 13 different views. Anomalous events include running, stealing, riding bicycle, jumping and fighting (Luo et al., 2017).

### 4.2 Evaluation metric

We evaluate with the highly used frame-level area under the receiver operating characteristic (AUROC) metric (Kiran et al., 2018). The ROC curve is obtained by varying the threshold on the frame level anomaly score, to separate anomaly from normality class across the whole test set. A higher value indication better performance. Some works compute a “AUROC per video” and report the average, also called macro-averaged AUC (Georgescu et al., 2021a; Georgescu et al., 2021b; Ristea et al., 2022). In this metric, the succession of thresholds to estimate the ROC curve is not common to all test videos. Since thresholds are adapted to each video, ROC curve is in risk to be over-fitted, providing overly optimistic performances. Consequently, AUROC should always be a “AUROC on all videos” (micro-averaged AUROC) computed on the whole test set with thresholds common to all test videos (Fawcett, 2006; Lohani et al., 2021).

### 4.3 Implementation details

We resize each video frame to  $256 \times 256$  and rescale pixels to the range  $[-1, 1]$ . To be comparable with

other methods, we use the widely popular 3D convolutional AE architecture (Gong et al., 2019; Astrid et al., 2021a; Astrid et al., 2021b), consisting of strided 3D convolutions for encoding and strided 3D deconvolutions for decoding. It takes a video clip of 16 frames in grayscale, *i.e.*,  $T=16$ ,  $C=1$ ,  $H=256$  and  $W=256$  respectively. The prediction head  $H_{FFP}$  is attached at the end of the AE and consists of a single 2D convolution, followed by a tanh activation. The playback rate prediction head  $H_{PRP}$  is attached at the end of the encoder and consists of a series of 3D pooling, 2D convolution and pooling and fully connected layers to produce an output of size 2, one for each class. The input clip for PRP task is chosen between original playback rate and accelerated playback rate with equal chance (50% probability for each). For each batch of accelerated playback rate, the value of  $s$  is chosen randomly from (2,3,4,5) with equal chance for the four values. The balance weights in the training objective function are set to  $\lambda_1=0.6$ ,  $\lambda_2=0.4$  and  $\lambda_3=1$  respectively and they were found using grid search on the overall loss. The whole model is trained end-to-end using the Adam optimizer (Kingma and Ba, 2015) with a learning rate of  $10^{-4}$  and a batch size of 16.

While testing, we use different measures like MSE, PSE and BPE for the anomaly score. For PSE and BPE, we use  $\sigma=1$ ,  $b=2$  while keeping the same kernel size of  $k=5$ . For blur kernel, we use a Gaussian filter. After grid search, we set the optimal weights for anomaly score  $(\alpha_1, \alpha_2, \alpha_3)$  as (0.1, 0.8, 1), (0.1, 1, 0.1) and (0.2, 0.2, 0.9) for Ped2, Avenue and ShanghaiTech dataset respectively.

## 5 RESULTS

### 5.1 Video Anomaly Detection

#### 5.1.1 Quantitative comparison with state of the art

Table 1 shows the results of our LUSS-AE method compared with existing state of the art methods. As explained in Section 2, we do not compare with methods having external supervision. The work of MNAD (Park et al., 2020) is re-implemented by (Menon and Stephen, 2021), and MPN (Lv et al., 2021a) is re-implemented by us using their provided source code. In both cases, the claimed results were not reproducible, and they are marked with \* in the table.

We can observe that our method outperforms all the other methods across all the datasets. The performance gain in Ped2 and Avenue datasets is less significant as in the Shanghai dataset. In fact, it has

Table 1: Quantitative comparison with the existing state of the art methods: AUROC (in %) for VAD is computed on Ped2, Avenue and Shanghai test sets. Numbers in bold indicate the best performance, and \* indicate non-reproducible results.

Method	Ped2	Avenue	Shanghai
AnoPCN (Ye et al., 2019)	96.80	86.20	73.60
MemAE (Gong et al., 2019)	94.10	83.30	71.20
UNet-inte (Tang et al., 2020)	96.30	85.10	73.00
Cluster AE (Chang et al., 2020)	96.50	86.00	73.30
MNAD (Park et al., 2020) *	97.00	88.50	70.50
MNAD (Menon and Stephen, 2021)	96.33	87.91	67.81
STEAL Net (Astrid et al., 2021b)	98.40	87.10	73.70
LNTRA (Astrid et al., 2021a)	96.50	84.91	75.97
MPN (Lv et al., 2021a) *	96.90	89.50	73.80
MPN [ours]	96.13	83.90	73.00
ITAE (Cho et al., 2022)	97.30	85.80	74.70
VQU-Net (Szymanowicz et al., 2022)	89.20	88.30	-
FastAno (Park et al., 2022)	96.30	85.30	72.20
LUSS-AE [ours]	<b>98.52</b>	<b>89.04</b>	<b>81.21</b>

been suggested to not use the Ped2 dataset as it is almost saturated (Accsintoae et al., 2022). The Shanghai dataset is considered one of the most difficult dataset and our high performance gain of 5.24% demonstrates the viability of our method. Furthermore, the fact that our method works on all the datasets, irrespective of the type of anomalies, shows the generalizing ability of our method. Even though, we use the same architecture for autoencoder like many other methods (Gong et al., 2019; Astrid et al., 2021a; Astrid et al., 2021b), still our proposed method outperforms them without using any sort of external memory or supervision. All these points demonstrate the strength and effectiveness of our LUSS-AE method.

### 5.1.2 Qualitative results

In this part, we discuss the strengths and weaknesses of our method via illustrative examples.

Figure 3 demonstrates an illustrative example of our method tested on a video with two anomalous events, both containing movement of bikes. Here, the people move with relatively normal speed while bikes move with fast speed. Also, the number of people are relatively less in this example and bike does occupy a big area, which means its displacement causes a big spatio-temporal change. We can observe that as soon as the bike enters the scene, we have a high jump in  $\mathcal{A}_{PRP}$  and it remains high until the bike exits the scene. It jumps up again in next scene and have highest value when two bikes move in the scene. Regarding  $\mathcal{A}_{VCR}$  and  $\mathcal{A}_{FFP}$ , the scores remain high when bikes are in the scene. Overall, our method detects both anomalous events in this example.

Figure 4 demonstrates the working of LUSS-AE on a test video of Shanghai dataset containing three different anomalous events: person turning in wrong direction and person jumping, brawling/chasing action, and stone picking. In the first anomalous event,  $\mathcal{A}_{VCR}$  and  $\mathcal{A}_{FFP}$  have higher values than  $\mathcal{A}_{PRP}$  in the beginning. The anomaly here consists of person turning in wrong direction which is well captured by the VCR and FFP task. Later, when the person jumped,  $\mathcal{A}_{PRP}$  suddenly increases, indicating its sensitivity to abrupt motion. During the second anomalous event, we observe that  $\mathcal{A}_{PRP}$  has higher values than  $\mathcal{A}_{VCR}$  and  $\mathcal{A}_{FFP}$ , thus contributing primarily to detect the anomaly. The  $\mathcal{A}_{PRP}$  starts to increase just before the start of this event because the person in red starts to suddenly approach the other person. We then observe a first peak of  $\mathcal{A}_{PRP}$  as one person pushes other to the ground. We later observe a big second peak of  $\mathcal{A}_{PRP}$  and this relates to fast movement chasing. However, the third event is very rare (picking up stones) and does not contain large spatio-temporal movement in the scene and thus our method fails to detect it. In fact, the score in later frames is slightly higher than the third event because there are three people in close proximity, trying to change directions, which is considered anomalous for Shanghai dataset. Overall, the VCR and FFP tasks work better in anomalies without abrupt motions and PRP task addresses the anomalies with sudden motions. There is still a room to improve the spatio-temporal comprehension of AE for VAD, possibly with a data augmentation technique as the datasets lack more examples of scenarios.

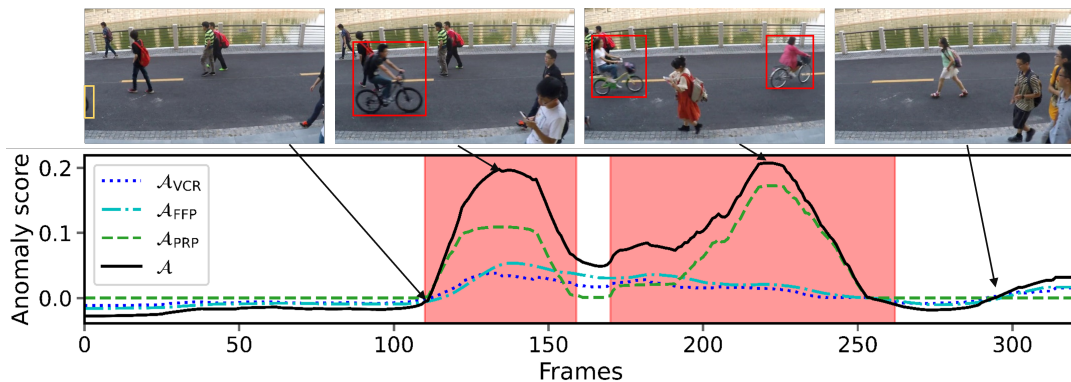

Figure 3: LUSS-AE working illustration on video 11\_0176 of Shanghai test set. Anomaly scores ( $\mathcal{A}_{VCR}$ ,  $\mathcal{A}_{FFP}$ ,  $\mathcal{A}_{PRP}$ ,  $\mathcal{A}$ ) are plotted per video frame; red regions depict anomalous events and some illustrative frames are shown above the plot, where the yellow and red bounding boxes exhibit objects of interest and anomalies respectively.

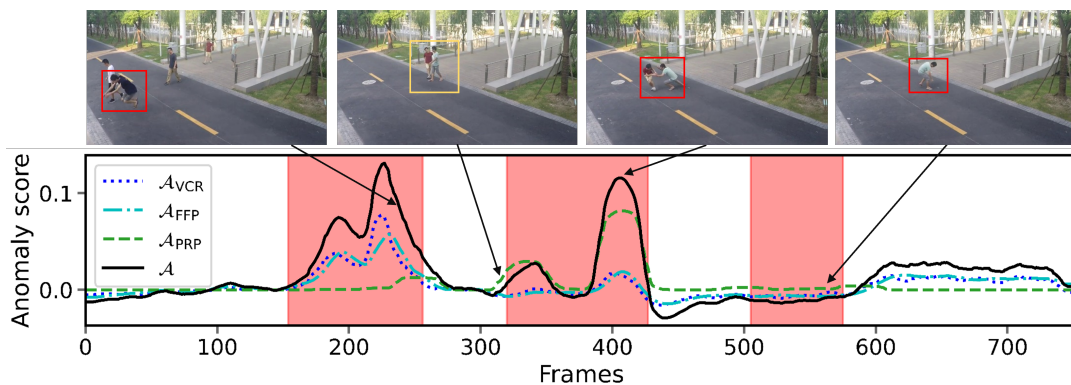

Figure 4: LUSS-AE working illustration on video 05\_0023 of Shanghai test set. Anomaly scores ( $\mathcal{A}_{VCR}$ ,  $\mathcal{A}_{FFP}$ ,  $\mathcal{A}_{PRP}$ ,  $\mathcal{A}$ ) are plotted per video frame; red regions depict anomalous events and some illustrative frames are shown above the plot, where the yellow and red bounding boxes exhibit objects of interest and anomalies respectively.

## 5.2 Ablation studies

In this subsection, we study the importance and influence of different parts of our proposed method.

### 5.2.1 Are all tasks useful for VAD?

In this ablation study, we analyze the impact of different tasks on the autoencoder for detecting anomalies. Table 2 shows combinations of different tasks and their respective AUROC performances on Avenue and Shanghai datasets. Concretely, for each of these combinations, we train and test AE using the chosen tasks, and use the introduced BPE wherever applicable.

We can observe that when AE is trained only with the VCR task, the VAD performance is the least, *i.e.*, 82.72% and 73.11%. We consider this as the baseline since this a standard task in VAD (Kiran et al., 2018) and we combine it with other tasks to assess their impact. Using VCR and FFP task together boosts the performance with a gain of 5.23%

and 3.24% over the baseline, indicating the importance of learning spatio-temporal propagation through the FFP task. Similarly, when PRP task is trained together with the VCR task, we observe an increase of 4.71% and 6.09% on baseline, validating that indeed PRP task enriches the comprehension of normal spatio-temporal features for anomaly detection. Finally, when all the tasked are used together, we observe a substantial yield in performance with 6.32% and 8.10% over baseline, demonstrating the effectiveness of our proposed approach to train AE by leveraging unsupervised and self-supervised tasks for VAD.

### 5.2.2 Is the autoencoder enriched by FFP and PRP?

In this paper, we have a 3D convolutional AE well-used in many previous works (Gong et al., 2019; Astrid et al., 2021a; Astrid et al., 2021b). All these works used AE with the VCR task. In this study, we first reproduced their work by training and testing AE with the VCR task. Then we trained AE with the pro-

Table 2: Influence of different tasks (VCR, FFP and FRP) used during training and testing of AE on Avenue and Shanghai datasets, in terms of AUROC (%).

Tasks			AUROC (%)	
VCR	FFP	PRP	Avenue	Shanghai
✓			82.72	73.11
✓	✓		87.95	76.35
✓		✓	87.43	79.20
✓	✓	✓	<b>89.04</b>	<b>81.21</b>

posed tasks, *i.e.*, VCR, FFP and PRP, and tested using only the VCR task. This way, we can assess the impact of these tasks on AE’s comprehension of normality during training in order to detect anomalies during testing.

Table 3 shows the impact of these tasks on AE. We can clearly remark that our proposed training tasks enriched the normality understanding of the autoencoder for VAD, with a gain of 3.76% and 2.26% in performance on Avenue and Shanghai datasets.

Table 3: Influence of tasks (VCR, FFP and FRP) used during training of AE on Avenue and Shanghai datasets, when tested only with VCR, in terms of AUROC (%).

Training tasks	Testing with VCR	
	Avenue	Shanghai
VCR	82.72	73.11
VCR + FFP + PRP	<b>86.48</b>	<b>75.37</b>

### 5.2.3 Are error measures equivalent?

The goal of this ablation study is to see the effect of different error measures, *i.e.*, MSE, PSE and BPE, on the VAD task. Since these measures apply to VCR and FFP tasks, PRP task will not be considered here.

Figure 5 shows an illustrative example using the FFP task to better understand these measures. We can observe that AE did not correctly predict this frame, where dropping bag is an anomaly. The error frame for MSE highlights this anomalous region of image but it also captures the background noise of the frame. The PSE error frame has a more visible region of anomaly and it smooths some background noise. Finally, the BPE error frame has a principal focus on anomalous region and has least amount of background noise. Furthermore, the BPE frame is smaller than other maps as we remove irrelevant pixels via subsampling.

Table 4 shows the quantitative impact of these error measures. To be precise, we train our method with the three tasks and test it with the respective tasks and measures shown in the table. We can observe

that the PSE improves the performance in both tasks with 1.01% and 1.23% respectively, signifying the importance of proximity error and noise reduction. BPE provides a significant boost in results with 1.53% and 1.62% performance improvement over MSE in the two tasks. This validates that our proposed BPE should be used for the VAD task whenever frames or clips are compared.

Table 4: Influence of error measure (MSE, PSE and BPE) on each task (VCR and FFP) during testing of AE on Avenue dataset, in terms of AUROC (%).

Error measure	Testing tasks	
	VCR	FFP
MSE	84.95	85.38
PSE	85.96	86.61
BPE	<b>86.48</b>	<b>87.00</b>

### 5.2.4 Are anomaly score rescalings equivalent ?

We introduced the robust scaling in our work. In Table 5, we provide the effect of rescaling scheme on Avenue and Shanghai dataset. Ped2 and Avenue dataset, being relatively simple and have smaller than the Shanghai dataset, does not have many extreme value outliers. We can observe in the table that due to this, we do not have a big increase in performance in Avenue dataset with robust scaling. However, we observe an impressive 2.06% increase in performance in Shanghai dataset. This shows the viability of Robust scaling, especially in the difficult dataset like Shanghai. Overall, the robust scaling should be used regardless of the dataset.

Table 5: Influence of anomaly score rescaling (Min-Max and Robust) on Avenue and Shanghai datasets, in terms of AUROC (%).

Rescaling	Avenue	Shanghai
Min-Max	89.01	79.15
Robust	<b>89.04</b>	<b>81.21</b>

## 5.3 Computational complexity

We use Nvidia GeForce RTX 3090 with 24 GB of memory for all our experiments. Since our method uses the 3DCAE proposed by (Gong et al., 2019) to build LUSS-AE, we must compare with their autoencoder. Table 6 shows the computational complexity comparison of our method with their autoencoder. We can observe that our method uses only a bit more of computational power both in terms of number of pa-

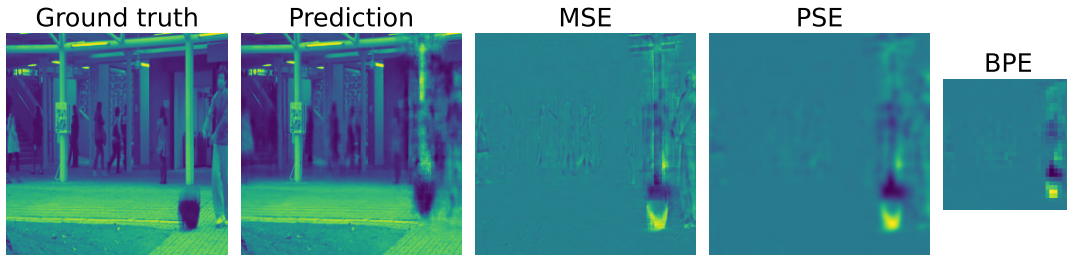

Figure 5: Illustration of different error measures on a test frame of the Avenue dataset. From left to right: actual frame (ground truth), predicted frame, error frame for MSE, for PSE and for BPE.

rameters and FLOPs (MAC). However, Section 5.1.1 of our paper shows that LUSS-AE largely outperform their method in all the three datasets.

Table 6: Computational complexity comparison of our method with the baseline autoencoder (Gong et al., 2019).

Method	#Params	FLOPs
3DCAE (Gong et al., 2019)	5.98M	16.23G
LUSS-AE [ours]	6.12M	16.30G

## 6 CONCLUSIONS

In this work, we tackled the problem of detecting video anomalies without annotations. To address this problem, we proposed a novel regime that leverages unsupervised and self-supervised learning on a single autoencoder. Our method is end-to-end trained on the normal data and jointly learns to discriminate anomalies from normality using three chosen tasks: (i) unsupervised video clip reconstruction; (ii) unsupervised future frame prediction; (iii) self-supervised playback rate prediction. To our knowledge, it was the first time when PRP task was adapted for video anomaly detection. Our ablation study demonstrated the importance of this task for unsupervised video anomaly detection. To correctly focus on anomalous regions in the video, we also proposed a new error measure, called the blur pooled error (BPE) and a robust rescaling of anomaly scores.

Our experiments demonstrate that the chosen tasks enriched the spatio-temporal comprehension of the autoencoder to better understand the normality for detecting anomalies. Furthermore, a significant boost in performance with respect to MSE showed the importance of the BPE as it removes the background noise by keeping only the pertinent pixels. Finally, the overall results prove the relevance of our LUSS-AE method since it outperformed all recent approaches in three challenging datasets.

In future works, we would like to explore training our method with BPE and further strengthening it with data augmentation techniques.

## REFERENCES

- Acsintoae, A., Florescu, A., Georgescu, M.-I., Mare, T., Sumedrea, P., Ionescu, R. T., Khan, F. S., and Shah, M. (2022). UBnormal: New benchmark for supervised open-set video anomaly detection. In *CVPR*, pages 20143–20153.
- Astrid, M., Zaheer, M. Z., Lee, J.-Y., and Lee, S.-I. (2021a). Learning not to reconstruct anomalies. In *BMVC*.
- Astrid, M., Zaheer, M. Z., and Lee, S.-I. (2021b). Synthetic temporal anomaly guided end-to-end video anomaly detection. In *ICCV*, pages 207–214.
- Benaïm, S., Ephrat, A., Lang, O., Mosseri, I., Freeman, W. T., Rubinstein, M., Irani, M., and Dekel, T. (2020). SpeedNet: Learning the speediness in videos. In *CVPR*, pages 9922–9931.
- Chang, Y., Tu, Z., Xie, W., and Yuan, J. (2020). Clustering driven deep autoencoder for video anomaly detection. In *ECCV*, pages 329–345.
- Cho, M., Kim, T., Kim, W. J., Cho, S., and Lee, S. (2022). Unsupervised video anomaly detection via normalizing flows with implicit latent features. *Pattern Recognit*, 129:108703.
- Fawcett, T. (2006). An introduction to ROC analysis. *Pattern Recognit Lett*, 27:861–874.
- Feng, J.-C., Hong, F.-T., and Zheng, W.-S. (2021). MIST: Multiple instance self-training framework for video anomaly detection. In *CVPR*, pages 14009–14018.
- Georgescu, M.-I., Barbalau, A., Ionescu, R. T., Khan, F. S., Popescu, M., and Shah, M. (2021a). Anomaly detection in video via self-supervised and multi-task learning. In *CVPR*, pages 12742–12752.
- Georgescu, M.-I., Ionescu, R., Khan, F. S., Popescu, M., and Shah, M. (2021b). A background-agnostic framework with adversarial training for abnormal event detection in video. *IEEE Trans Pattern Anal Mach Intell*.
- Gong, D., Liu, L., Le, V., Saha, B., Mansour, M. R., Venkatesh, S., and van den Hengel, A. (2019). Memorizing normality to detect anomaly: Memory-augmented deep autoencoder for unsupervised anomaly detection. In *ICCV*, pages 1705–1714.

- Gudi, A., Büttner, F., and van Gemert, J. (2022). Proximally sensitive error for anomaly detection and feature learning. *arXiv preprint arXiv:2206.00506*.
- Hasan, M., Choi, J., Neumann, J., Roy-Chowdhury, A. K., and Davis, L. S. (2016). Learning temporal regularity in video sequences. In *CVPR*, pages 733–742.
- Ionescu, R. T., Khan, F. S., Georgescu, M.-I., and Shao, L. (2019). Object-centric auto-encoders and dummy anomalies for abnormal event detection in video. In *CVPR*, pages 7842–7851.
- Kingma, D. P. and Ba, J. (2015). Adam: A method for stochastic optimization. In *ICLR*.
- Kiran, B. R., Thomas, D. M., and Parakkal, R. (2018). An overview of deep learning based methods for unsupervised and semi-supervised anomaly detection in videos. *J Imaging*, 4:36.
- Li, W., Mahadevan, V., and Vasconcelos, N. (2013). Anomaly detection and localization in crowded scenes. *IEEE Trans Pattern Anal Mach Intell*, 36:18–32.
- Liu, W., Luo, W., Lian, D., and Gao, S. (2018). Future frame prediction for anomaly detection—a new baseline. In *CVPR*, pages 6536–6545.
- Liu, X., Zhang, F., Hou, Z., Mian, L., Wang, Z., Zhang, J., and Tang, J. (2021a). Self-supervised learning: Generative or contrastive. *IEEE Trans Knowl Data Eng*.
- Liu, Z., Nie, Y., Long, C., Zhang, Q., and Li, G. (2021b). A hybrid video anomaly detection framework via memory-augmented flow reconstruction and flow-guided frame prediction. In *ICCV*, pages 13588–13597.
- Lohani, D., Crispim-Junior, C., Barthélemy, Q., Bertrand, S., Robinault, L., and Tougne, L. (2021). Spatio-temporal convolutional autoencoders for perimeter intrusion detection. In *RRPR*, pages 47–65.
- Lu, C., Shi, J., and Jia, J. (2013). Abnormal event detection at 150 fps in Matlab. In *ICCV*, pages 2720–2727.
- Luo, W., Liu, W., and Gao, S. (2017). A revisit of sparse coding based anomaly detection in stacked RNN framework. In *ICCV*, pages 341–349.
- Lv, H., Chen, C., Cui, Z., Xu, C., Li, Y., and Yang, J. (2021a). Learning normal dynamics in videos with meta prototype network. In *CVPR*, pages 15425–15434.
- Lv, H., Zhou, C., Cui, Z., Xu, C., Li, Y., and Yang, J. (2021b). Localizing anomalies from weakly-labeled videos. *IEEE Trans Image Process*, 30:4505–4515.
- Menon, V. and Stephen, K. (2021). Re learning memory guided normality for anomaly detection. In *ML Reproducibility Challenge 2020*.
- Park, C., Cho, M., Lee, M., and Lee, S. (2022). FastAno: Fast anomaly detection via spatio-temporal patch transformation. In *WACV*, pages 2249–2259.
- Park, H., Noh, J., and Ham, B. (2020). Learning memory-guided normality for anomaly detection. In *CVPR*, pages 14372–14381.
- Ramachandra, B., Jones, M. J., and Vatsavai, R. R. (2022). A survey of single-scene video anomaly detection. *IEEE Trans Pattern Anal Mach Intell*, 44:2293–2312.
- Ristea, N.-C., Madan, N., Ionescu, R. T., Nasrollahi, K., Khan, F. S., Moeslund, T. B., and Shah, M. (2022). Self-supervised predictive convolutional attentive block for anomaly detection. In *CVPR*, pages 13576–13586.
- Sinha, P. and Russell, R. (2011). A perceptually based comparison of image similarity metrics. *Perception*, 40:1269–1281.
- Szymanowicz, S., Charles, J., and Cipolla, R. (2022). Discrete neural representations for explainable anomaly detection. In *WACV*, pages 148–156.
- Tang, Y., Zhao, L., Zhang, S., Gong, C., Li, G., and Yang, J. (2020). Integrating prediction and reconstruction for anomaly detection. *Pattern Recognit Lett*, 129:123–130.
- Tian, Y., Pang, G., Chen, Y., Singh, R., Verjans, J. W., and Carneiro, G. (2021). Weakly-supervised video anomaly detection with robust temporal feature magnitude learning. In *ICCV*, pages 4975–4986.
- Wang, J., Jiao, J., and Liu, Y.-H. (2020a). Self-supervised video representation learning by pace prediction. In *ECCV*, pages 504–521.
- Wang, Z., Zou, Y., and Zhang, Z. (2020b). Cluster attention contrast for video anomaly detection. In *ACM Int Conf Multimed*, pages 2463–2471.
- Yao, Y., Liu, C., Luo, D., Zhou, Y., and Ye, Q. (2020). Video playback rate perception for self-supervised spatio-temporal representation learning. In *CVPR*, pages 6548–6557.
- Ye, M., Peng, X., Gan, W., Wu, W., and Qiao, Y. (2019). AnoPCN: Video anomaly detection via deep predictive coding network. In *ACM Int Conf Multimed*, pages 1805–1813.
- Yu, G., Wang, S., Cai, Z., Zhu, E., Xu, C., Yin, J., and Kloft, M. (2020). Cloze test helps: Effective video anomaly detection via learning to complete video events. In *ACM Int Conf Multimed*, pages 583–591.
- Zhang, R. (2019). Making convolutional networks shift-invariant again. In *ICML*, pages 7324–7334.
- Zhao, Y., Deng, B., Shen, C., Liu, Y., Lu, H., and Hua, X.-S. (2017). Spatio-temporal autoencoder for video anomaly detection. In *ACM Int Conf Multimed*, pages 1933–1941.