



**HAL**  
open science

## A Practical Approach to Launch the Low-Cost Monitoring Platforms for Nearly Net-Zero Energy Buildings in Vietnam

Thi Tuyet Hong Vu, Benoit Delinchant, Anh Tuan Phan, van Cong Bui, Dinh  
Quang Nguyen

► **To cite this version:**

Thi Tuyet Hong Vu, Benoit Delinchant, Anh Tuan Phan, van Cong Bui, Dinh Quang Nguyen. A Practical Approach to Launch the Low-Cost Monitoring Platforms for Nearly Net-Zero Energy Buildings in Vietnam. *Energies*, 2022, 15 (13), pp.4924. 10.3390/en15134924 . hal-04017264

**HAL Id: hal-04017264**

**<https://hal.science/hal-04017264>**



Submitted on 7 Mar 2023

**HAL** is a multi-disciplinary open access archive for the deposit and dissemination of scientific research documents, whether they are published or not. The documents may come from teaching and research institutions in France or abroad, or from public or private research centers.

L'archive ouverte pluridisciplinaire **HAL**, est destinée au dépôt et à la diffusion de documents scientifiques de niveau recherche, publiés ou non, émanant des établissements d'enseignement et de recherche français ou étrangers, des laboratoires publics ou privés.

## Article

# A Practical Approach to Launch the Low-Cost Monitoring Platforms for Nearly Net-Zero Energy Buildings in Vietnam

Thi Tuyet Hong VU<sup>1</sup>, Benoit DELINCHANT<sup>2,\*</sup> , Anh Tuan PHAN<sup>1</sup>, Van Cong BUI<sup>3</sup>   
and Dinh Quang NGUYEN<sup>4</sup> 

<sup>1</sup> Energy Department, University of Science and Technology of Hanoi, VAST, Hanoi 10999, Vietnam; hongytt@st.usth.edu.vn (T.T.H.V.); phan-anh.tuan@usth.edu.vn (A.T.P.)

<sup>2</sup> Université Grenoble Alpes, CNRS, Grenoble INP, G2Elab, 38000 Grenoble, France

<sup>3</sup> Electronics Faculty, Vietnam-Korea Vocational College of Hanoi City, Hanoi 10999, Vietnam; congbv.vhh@gmail.com

<sup>4</sup> Institute of Energy and Science, VAST, Hanoi 10999, Vietnam; ndquang@ies.vast.vn

\* Correspondence: benoit.delinchant@grenoble-inp.fr

**Abstract:** Buildings with solar rooftops have become vital objects in the energy transition in Vietnam. In this context, the demand for research on energy management solutions to use energy efficiently and increase PV energy absorption capacity is rising. In this paper, we present a practical route to developing a low-cost monitoring platform to meet the building energy management in the country. First, our project built a monitoring architecture with high-density wireless sensors in an office building in Vietnam. Next, we discussed the influence of significant obstacles such as technical issues, users, and cost on the resilience and reliability of the monitoring system. Then, we proposed essential solutions for data quality improvement by testing sensors, detecting wireless sensor network errors, and compensating for data losses by embedding machine learning. We found the platform's potential in developing a rich database of building characteristics and occupants. Finally, we proposed plans exploiting the data to reduce wasted energy in equipment operation, change user behaviors, and increase auto-consumption PV power. The effectiveness of the monitoring platform was an approximate 62% energy reduction in the first year. The results are a cornerstone for implementing advanced research as modeling and real-time optimal control toward nearly zero-energy buildings.

**Keywords:** monitoring platforms; buildings energy efficiency; user feedback; wireless sensors



**Citation:** VU, T.T.H.; DELINCHANT, B.; PHAN, A.T.; BUI, V.C.; NGUYEN, D.Q. A Practical Approach to Launch the Low-Cost Monitoring Platforms for Nearly Net-Zero Energy Buildings in Vietnam. *Energies* **2022**, *15*, 4924. <https://doi.org/10.3390/en15134924>

Academic Editors:

Alessandro Cannavale and  
Angelo Zarrella

Received: 29 April 2022

Accepted: 1 July 2022

Published: 5 July 2022

**Publisher's Note:** MDPI stays neutral with regard to jurisdictional claims in published maps and institutional affiliations.



**Copyright:** © 2022 by the authors. Licensee MDPI, Basel, Switzerland. This article is an open access article distributed under the terms and conditions of the Creative Commons Attribution (CC BY) license (<https://creativecommons.org/licenses/by/4.0/>).

## 1. Introduction

Buildings contribute around 35–40% of total energy consumption, causing rising CO<sub>2</sub> emissions in Vietnam [1]. Therefore, implementing net-zero energy buildings with effective energy solutions and green energy is essential. Vietnam has high potential solar energy, with average annual irradiation of 5 kWh/m<sup>2</sup> [2]. In addition, in recent years, due to the government's supportive policies, the development rate of grid-tied PV systems has been much higher than the installed capacity in the Revised National Power Development Master Plan [2,3]. It helped Vietnam ensure the security of power sources and reduce coal power generation and CO<sub>2</sub> emissions. In this context, rooftop solar generation lowers transmission power losses and investment costs in power system infrastructure and promotes user participation in the energy transition [4].

However, the overdevelopment of rooftop solar power generation in a short period leads to pressure on the transmission power line and distributed grid, especially on distribution grids in load centers such as cities and industrial zones. That causes reverse currents and local voltage surges at some connecting load nodes. At the end of 2020, solar rooftop projects registered around 8300 projects of 4.7 MWp connected to power network [5]. This pressure led the national grid managers (The Electricity of Vietnam—EVN) to suspend rooftop solar PV generation integration into the distribution grid. The favorable policy

for solar power development in [4] expired after 31 December 2020. Electricity from new solar power projects, when connected to the grid, will not be purchased by EVN until new regulations are issued. [6]. So, enhancing local self-consumption solutions of rooftop PV generation sources is preferred for energy efficiency and continuing the next rooftop solar generation projects in Vietnam. Nowadays, on-site renewable energy resources are integrated into the building energy supply at a low cost [7,8]. The authors of [9] pointed out the benefits of energy storage in office buildings to absorb solar electricity on-site in northeast Vietnam.

In many studies, monitoring technologies have also been considered to increase PV absorption capacity [10], hosting capacity for small and micro-distribution grids [11], energy efficiency, and user feedback in the building [12]. Building energy efficiency generally requires a synchronized combination of architecture design, system operation (for example, HVAC system and other energy-consuming devices), and user routines and behaviors [13,14]. The missing measured data could lead to a low assessment of the influent features on efficiency energy in the building. Although the inverter's monitoring module could record energy production, storage, and consumption data, other information such as indoor/outdoor conditions, users' activities, electrical components, and building architecture should be added to optimize electricity bills [15] and change users' energy behaviors [13,16].

A monitoring system should make it possible to carry out a specific diagnosis for each building to optimize its renovation [17]. Furthermore, it must allow the realization of a model of the occupants' behavior, for instance, the opening of the windows [18]. The monitoring of indoor conditions (T, RH, CO<sub>2</sub>, energy sensors) and weather should give a better understanding of the occupants' behavior regarding energy consumption and, consequently, the use of the PV and battery energy system [19].

A monitoring platform can be considered an excellent solution to implement energy management solutions in buildings. On the one hand, the monitoring platform provides a rich data source for applied studies on energy efficiency in buildings. Additionally, it verifies the solution's effectiveness based on the control system. Figure 1 illustrates the main blocks in energy efficiency management and the monitoring system as a center block to collect and provide a database to assess user behaviors and energy strategies.

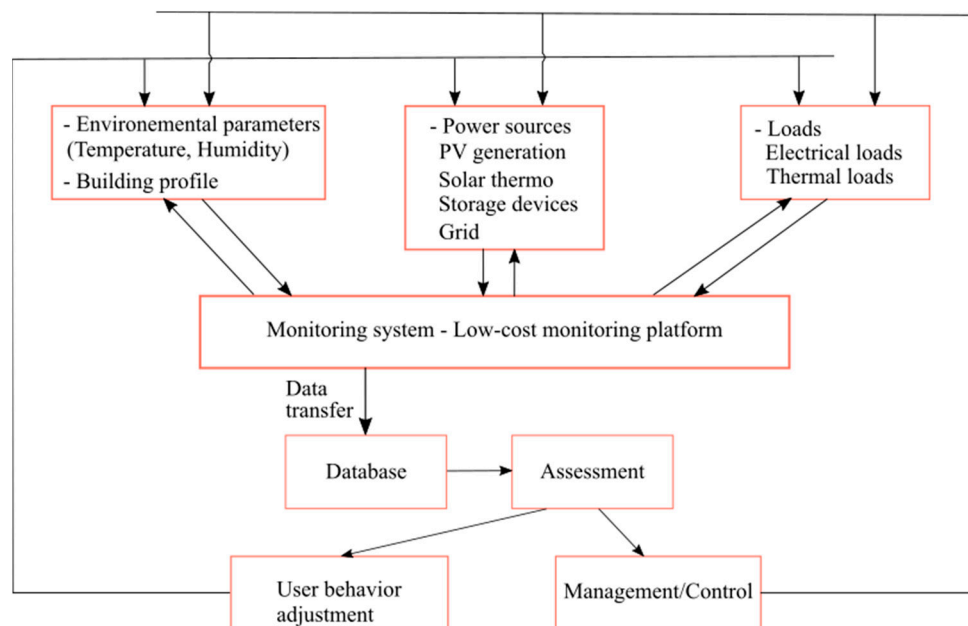

**Figure 1.** Schematic of energy efficiency management and role of monitoring platform.

Despite the many benefits, surveillance technologies have not been widespread in buildings in Vietnam. In the literature review, the authors in [20] presented 27 barriers to applying energy efficiency technologies. In addition, the challenges in researching and adopting energy efficiency technologies in Vietnam were listed in the National Energy Efficiency Program 2019–2030 [21]. In this work, we investigated key barriers to monitoring platforms in Vietnam.

- **Key issues of the monitoring platforms:**

- The complexity infrastructure of existing buildings affects the deployment of monitoring system such as sensor network structure, communication technologies, and installed locations.
- Applying high technologies requires the support of expert knowledge (hardware and software), and they are costly, which could limit their applications in medium- and small-scale building monitoring.
- Role of users still has not been considered sufficiently in designing and choosing technologies for monitoring platforms. Missing co-construction with users makes users misunderstand good practice ideas and implement energy solutions ineffectively.
- Lacking information feedback on buildings has created a gap in exploiting energy efficiency. In Vietnam, users can only access monthly total consumption data through EVN's website. Lacking of high-resolution building data (daily, hourly, and by minute) for real-time control strategies, determine energy-cuts solutions and upgrade/replace electrical devices.
- System resilience is always a challenge in building management systems. There is a shortage of highly technical experts to handle data and maintenance issues for low-cost monitoring systems. Therefore, surveillance solutions could be approached by low skill-users.

- **The state of the art:**

Monitoring solutions have evolved from industrial automated systems to the advent of IT players, standards and associated technologies, and their tendency towards open hardware/open source [22]. Embedded technology, wireless infrastructure, and open source are popular in monitoring systems [7]. The open hardware of Arduino, Raspberry pi, and the wireless modules such as Wi-Fi, RF24, and Z-Wave are easy installation, while open sources such as OpenHab, Grafana, and InfluxDB are for data centers and visualization development.

Lower-cost sensors should help increase the number of measured points in the platform to achieve more data [8], but they could also increase the number of technical issues [10].

Ensuring the quality of sensor data and system resilience are important tasks in surveillance applications. Some authors presented sensor issues regarding control strategies in HVAC systems [23].

An experiment with the practical problems of energy monitoring systems and the relevance of eco-feedback in [24] gives a better awareness of challenges related to interaction frequency with feedback devices, location installation, and security in the real world.

Our research scope is limited to monitoring systems for the energy management of households or buildings with PV installation, where the owner does not have much capital for investment. The monitoring system required satisfies the objective of energy-efficient utilization in PV-installed buildings. This study was conducted on case studies in Vietnam.

- **Goals and contributions of this work:**

This research defines the practical steps for developing low-cost monitoring platforms in buildings. This work experimented on a case study in Vietnam. Our goals include:

1. Proposing a low-cost monitoring infrastructure based on open hardware and sources, adapted to the energy context of the country. Wireless sensor networks (WSNs)

with a massive number of measured points were integrated to develop a building energy database. We guide how to exploit the data of buildings and users for energy management.

2. Proposing possible solutions to solve data quality issues and maintenance issues
3. Proposing monitoring plans to solve building energy issues:
  - Monitoring electrical devices' performance for replacing/upgrading or maintaining devices.
  - Monitoring user behaviors for changing energy awareness and habits
  - Increasing self-consumption rate of the solar rooftop-buildings.

## 2. Methodology Approach to Launch a Monitoring Platform

This research approach for developing a monitoring system is based on the requirements as follows: (1) the monitoring system must be able to measure as many of the building's physical parameters to evaluate and identify the building's energy-related states. (2) The monitoring system's configuration must apply IoT technologies, open-source, communicate and cooperate with neighboring micro-grids energy management systems. (3) The monitoring system must be low-cost and applicable in buildings, including PV-installed buildings.

### 2.1. Creating Profile of Buildings

The user's role in the process of building and operating the monitoring system is critical. Therefore, it is necessary to determine the actual needs of users in the building. In this study, the building's profile should be based on the occupants' feedback to develop a user-friendly and easy-to-use monitoring system. The profile is often developed in building design and simulation software. However, it is complex, time-consuming, and requires license keys. Therefore, for most small-medium projects with a low budget, we create building profile sheets using Excel, including the following fields:

- Project information: targets (research/utility), timeline, and budget of the project;
- Building architecture: location; area; type (office buildings/hotel/residential/etc.); age of building; function zones, etc.;
- Occupancy density; internal sub loads (lightings, HVAC, plugs, etc.);
- Operation schedule (occupancy, equipment, opening);
- Weather conditions (temperature, humidity, irradiation, etc.)
- Based on the energy consumption of buildings;
- Standard references such as international standards (ASHRAE 55-2004), the National Energy Efficiency Building Code QCVN 09:2017/BXD (VEEBC);
- User interest: for example, cost, time, and comfort or desire to contribute to environmental protection, etc.

### 2.2. Design and Installation Monitoring Platform

Recently, embedded technologies' evolution allowed reduced sensor costs and extended their applications in buildings. In Figure 2, the building monitoring and control system architecture includes:

- Smart sensors support monitoring energy and environmental conditions. Wireless sensors are linked together in a tree, a star, or a mesh network [25].
- Smart actuators support changing building states through electrical devices (lighting system, air conditioning and plugs).
- A gateway could use for communication conversion by multiple interfaces (RF24/Wi-Fi, ZigBee/Wi-Fi, Z-Wave/Wi-Fi, Bluetooth, etc.). In addition, a gateway supports managing automation at the local level. We used a messaging protocol in IoT applications called MQTT for minimal network bandwidth in transport data.
- A nano-computer (Raspberry Pi) is used for the local data center, developing algorithms and control tasks.

- Open sources such as Influx DB were used for data storage and access to time-series data; Grafana was used for data visualization, and OpenHab for the user interface. A cloud part supports managing human interaction and databases.
- Constraint parts: electrical price, source, storage, and users.

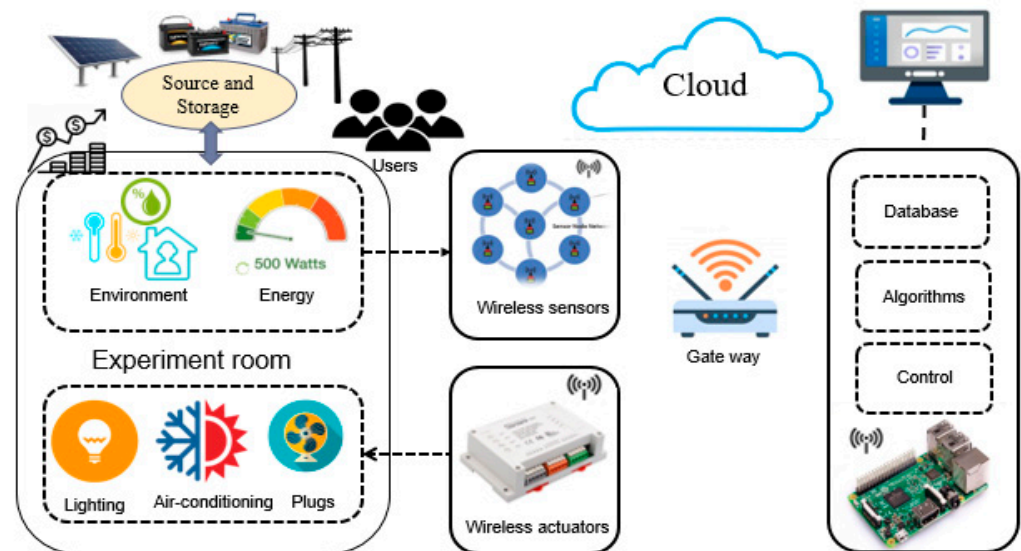

Figure 2. Building monitoring and control system architecture.

**Wireless sensor architecture:** Figure 3 illustrates a wireless sensor architecture that includes a power block (AC/DC adapter or battery), power monitoring block, sensor module, microcontroller center unit (as a brain of sensors in which to embed algorithms), and wireless module (data transceiver). Some notes when choosing sensors, such as physical characteristics/desired accuracy/types of sensors/location of sensors, allow us to obtain better measurements/operating conditions of sensors/acceptable cost. Moreover, the sampling rate, uploading time, and recorded timestamp parameters [10] should be configured.

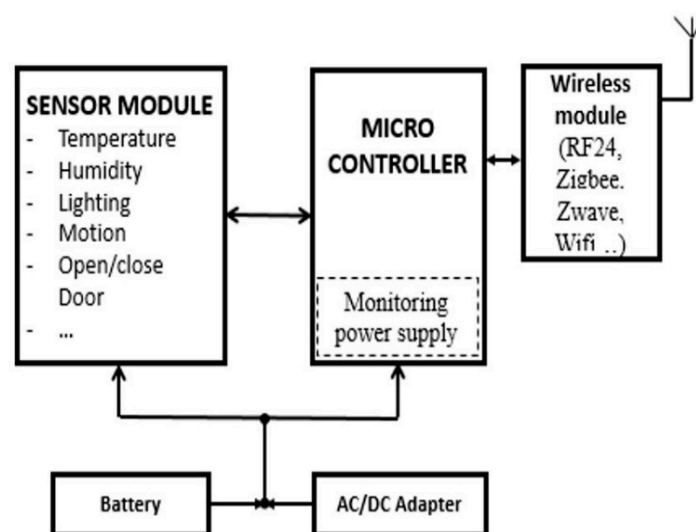

Figure 3. Overview of wireless sensor architecture.

**Communication technologies:** Some key factors of communication technology were presented in [25], including low cost, low energy consumption, ease of use, security, less interference, flexible capability interoperability, extensibility, and anti-interference ability,



available in the local market. Current popular wireless modules include Rf24, ZigBee, Z-Wave, Wi-Fi, and Lora [8]. The characteristics of these modules consist of frequency, working range, data rate, power consumption, transceiver capacity, and network structure. The wireless sensors are linked together in a tree, a star, or a mesh network [25].

**Quantity of measured points:** This depends on our aims of using the data, for example, to model occupants' behavior, energy systems, and thermal envelope/define energy efficiency indicators/warning and maintenance (wireless sensors' battery, errors).

**Data quality of low-cost monitoring platform:** This is a challenge. Testing sensors should be performed before/after installation. Overview of fault sensors and WSN, and improving solutions were found in [26,27]. Data processing should be performed by filtering, aggregating/smoothing data, and filling data gaps (holes in the measurements)/transforming data. Data fusion should improve information at a lower cost and better quality. In [10], making inferences using sensor data could reduce technical risks and maintenance by reducing the number of sensor nodes. Embedded machine learning is used for developing virtual sensors, for example, occupant calculation by the correlation of motion and open/close door; correlation of temperature sensors in the network. Developing a virtual sensor for calibration based on the 'virtual in situ calibration method' [28]. These approaches improve sensor networks' resiliency and flexibility by providing auto-detection and fixing sensor error tools. Estimating errors factors are often used, such as Root Mean Square Error (RMSE), Mean Absolute Percentage Error (MAPE), and Mean Relative Error (MRE) [29], or Standard Deviation (STD) [30].

**Visualization data:** We have to decide which information should be displayed. Display information should help users understand their system and suggest solutions to reduce energy consumption. This part should be co-constructed with users. Key indicators should be considered, such as (kWh/year, the portion of consumption parts, peak power consumption, self-consumption level; payback period of the project (based on electricity bill and investment cost); and user feedback (based on user behaviors and consumption correlation).

### 2.3. Building Energy Management Services

Building services should ensure improved life quality, a significant reduction in energy consumption, and increasing renewable energy sources for decarbonization.

**Surveillance services:** Users can access services through the display screen, a smartphone, or computer to view the data of building climate, energy consumption, PV power production, operating status of electrical equipment, power supply of sensors, and openings.

**Maintenance services:** prediction faults/warnings.

**Control services:** automatic control, On/Off, and predictive control.

**Data analysis and report:** building owners are provided a report with real-time information on building status to decide on improvement or preventive methods. In addition, the obtained critical data of the platform can be provided to the local utility and contribute to the optimal operation of the distribution grid [14].

## 3. Implementation of a Case Study in Vietnam

Basing the project of training IoT technologies on building energy cooperation between Vietnam and Korea in the Vocational college of Hanoi (VHH) and The University of Science and Technology (USTH) and the research project on solutions to integrate rooftop PV energy sources into the distribution grid of the Institute of Energy Science (IES), the prototype of low-cost monitoring for energy efficiency management of the building was implemented in VHH campus, Dong Anh, Hanoi.

The building in VHH is presented in Figure 4 and is responsible for the rising energy demand and monthly electricity bill costs. Therefore, we aspire to launch an energy management project on the intelligent campus. In phase 1 of the project, a room in the main building was used for the experiment. In the framework of the project, the college coop-

erated with universities to conduct research and training activities related to monitoring technologies and energy efficiency.



Figure 4. Overview of experimental room in VHH.

In this work, the PV system was located at a latitude/longitude of 21.2°N/106.06°E with direction Azimuth/tilt angle of 10.37°/25.33° (Figure 5). The configuration of the PV system includes: a Hybrid Dye Inverter 5 kW 1 phase; PV nominal power of 440 Wp (06 Mono-Si panels) by Suntech; and 06 lead-acid battery (Rocket L-875 8 V 170 AH) work in series.

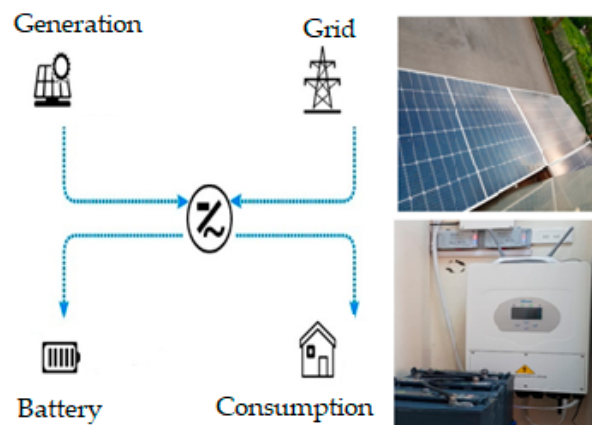

Figure 5. A demonstration of PV system in VHH's project.

After estimating the energy consumption of an office in a whole year, some options have been proposed, including the integration of PV systems and using a wireless sensor network (WSN) infrastructure to monitor electricity demand, human activities, and building environmental conditions. The control load systems such as air conditioning, lighting, and outlet loads are also supported in the platform.

Figure 6 shown the proposed design of WSANs in our monitoring platform. The monitoring architecture include: a raspberry pi 3 works as the server and 03 gateways of sensor networks (RF24/Wi-Fi, Z-Wave Stick AEOTEC, ZigBee/Wi-Fi Xiaomi Aqara) to transmit measured data from WSNs to server and command from server to actuators. **Wireless sensors in RF24 network:** 01 Multi-sensor BME280 (self-develop), RF24 power meters: 01 phase meter (01 unit) for monitoring a water dispenser consumption, 04 phases meter



(01 unit) for monitoring consumption of HVAC, lighting system, other plugs, and loads). **Wireless sensors in Z-Wave network:** 04 Z-Wave multisensor6 (Aeotec). **Wireless sensors in ZigBee network:** 02 Multi-sensor (temperature, humidity) of Xiaomi, 03 door sensors of Xiaomi. **Wi-Fi actuators:** 4CH Wi-Fi Son-off Pro (02 units) for control 8 channels of Led; 1CH Relay Broadlink Wi-Fi (01 unit) for control a water dispenser, 01 air-conditioning controller.

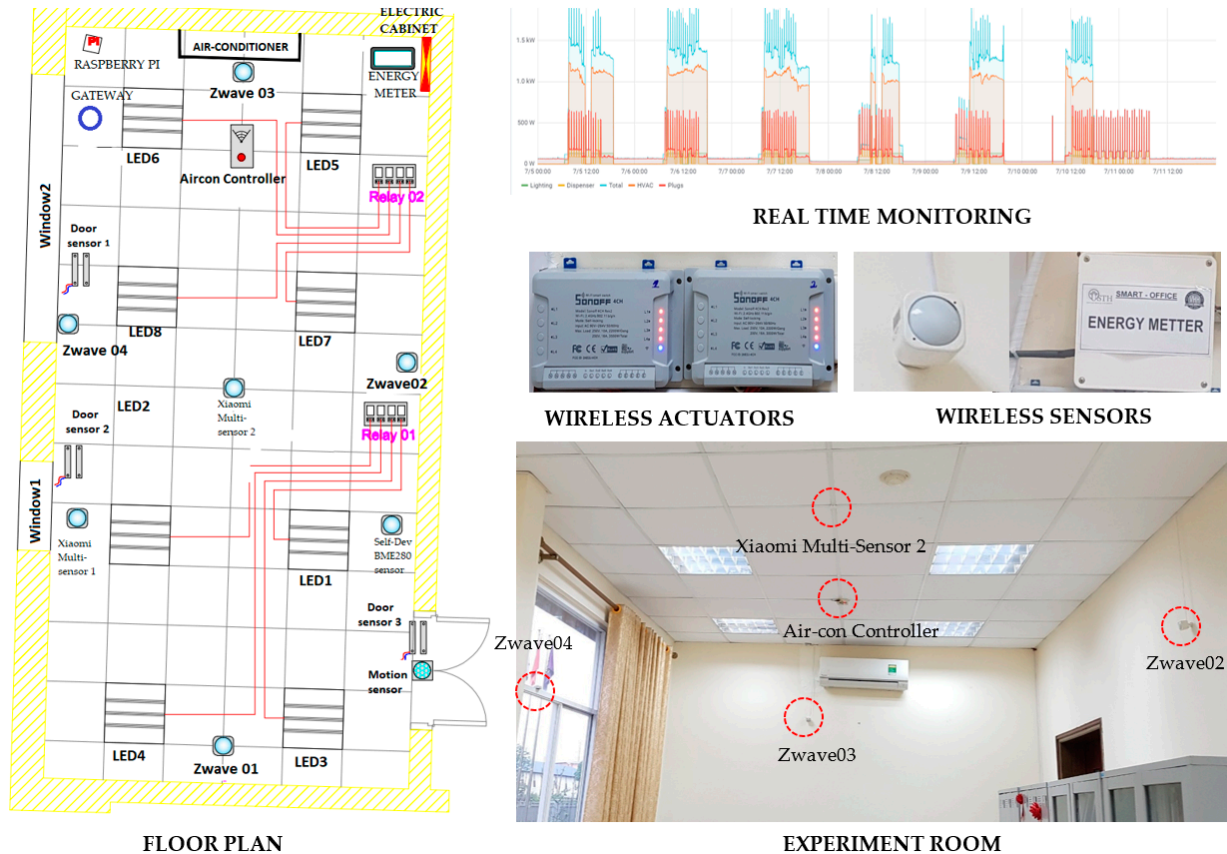

**Figure 6.** A demonstration of the wireless sensor and actuator networks (WSANs) in experiment room.

In this platform, building services included the following: (1) monitoring building status, weather forecasting from web-service (<https://openweathermap.org> accessed from 13 April 2020) updated data every 1 h; energy consumption of branch loads and total loads; PV (power production, voltage, current), battery (voltage, current, power battery, SOC, energy charging/discharging, temperature), power import/export, energy import/export grid; and energy charge/discharge battery, self-consumption rate. (2) Maintenance devices performance/sensor battery/power loads/working time of devices. Users are supported to detect low battery, fault sensors, and abnormalities of electric devices to replace or repair. (3) Automatic control (users schedule water dispenser). Figure 6 shows the lighting controller and air-con controller in our platform. The user can control loads to adapt to PV power production and storage energy of the PV system (configure parameters of the PV system or switch loads into the backup loads port of inverter). (4) The database could be accessed and analyzed to evaluate energy factors and improvement solutions.

#### 4. Results

In this section, we would like to point out the results of practices of the monitoring platform, then evaluate the effect of information feedback on building energy issues. In

addition, we would also like to use this result in the following research on the optimal real-time control of energy management for the micro-grid.

#### 4.1. Practicing the Low-Cost Monitoring with the Wireless Sensor Networks in a Case Study

Besides commercial sensor networks provided by manufacturers such as Xiaomi and Aeotec, self-developed sensor networks by the community are based on open hardware Arduino and wireless modules. In this work, our RF24 sensor network integrated a self-developed sensor with a BME280 module, 02 energy meters using a Pzem004T module, and 01 RF24/Wi-Fi gateway. In this network, users can customize extensive networks by embedded programming to adapt to real situations.

In the platform, the selected wireless sensors and actuators should move toward energy management objectives:

- Users' behaviors: motion and open/close door linked to presence, set-point temperature and lighting status data linked to energy behaviors;
- Building status: lighting level (average and uniformity), indoor temperature (air and walls), and weather temperature linked to comfort;
- Door and window status to know thermal leakage rates;
- Energy consumption data of plugs, air conditioning, and lighting, local energy production (PV system), and solar irradiance data linked to energy models;
- Power and voltage monitoring data at the grid connection point should contribute to the safe operation of micro-grids and the local utility. For example, ensure voltage quality, avoiding the cut-out of PV systems off the grid.

The monitoring platform allows storing and retrieving time series data consisting of environmental and energy data, user actions (door opening and closing behavior, movements in the room, user interactions on lighting and air-conditioning controllers, and sensor battery levels. Figure 7 describes guidance on monitoring platforms, including data fusion, modeling, control algorithms, and buildings energy services.

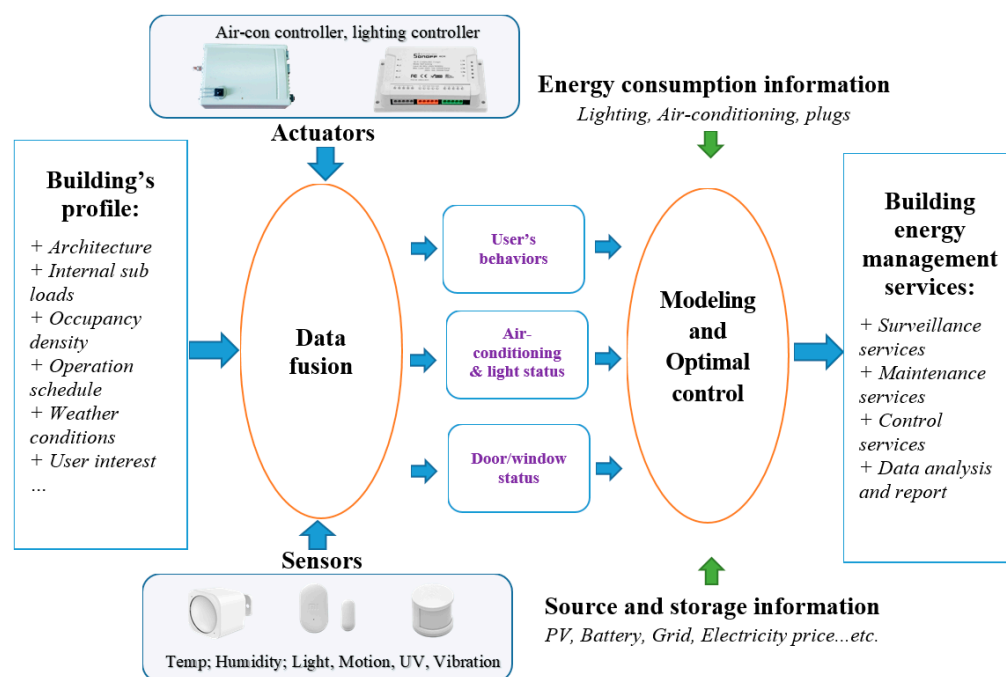

Figure 7. Guidance for using the monitoring platform.

#### 4.2. Possible Solutions to Solve Data Quality Issues, Maintenance Issues

The development of a low-cost monitoring platform for efficient building energy management has to face various obstacles (such as low data quality and communication

failure). This section presents some problems encountered in actual implementation and some measures whose data quality can be improved by users.

**Data issues** (accuracy, sampling rate, and working environment conditions of sensors) affect the quality of monitoring platforms. Additionally, many random variables are difficult to predict in sensor operations [31].

- Testing independent sensors:

Error assessment and calibration are complex steps and are difficult to access by non-specialist users. Besides commercial sensors, the current trend for many users is to self-develop intelligent sensors based on Arduino hardware and sensor modules for monitoring systems. For non-expert users, to be sure about the quality of these sensors, users can evaluate the actual self-developed sensors under operating conditions and compare them with commercially available sensors.

In our test, the multi-sensor BME280 (self-developed) and Z-Wave multisensor6 (Aeotec) were placed close together and took measurements over two months. In Figure 8, the results show that the self-developed BME280 has a significant gap humidity value of 15% when room humidity was over 80%. The purpose of this work is for us to evaluate the cause of the error of the self-developed sensor. The box design of the BME280 could affect humid sensor data due to limited air circulation.

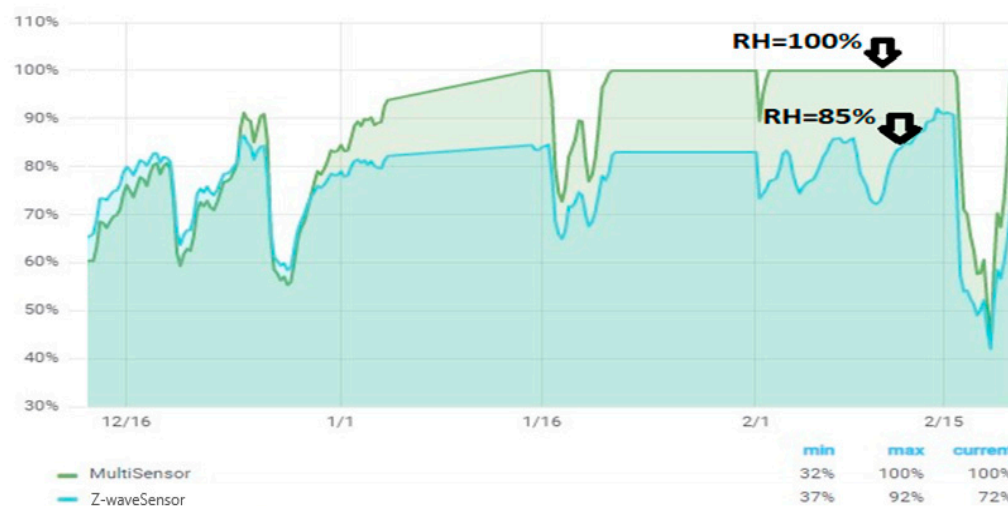

**Figure 8.** Operation of two sensors from 16 December 2019 to 15 February 2020.

In addition, we performed another test to improve the accuracy of the RF24 power meter by determining the effect of the sample rate and the sample mean. According to [30], an essential factor can reduce measurement uncertainty by increasing the sampling rate and averaging the measured samples. The sampling rate shown in [29] is seconds to minutes for each sample, and the data upload time is 1 s to 5 min. We found that functions in Arduino provide significant support for improving data quality. For example, in our test [10], the energy meter with embedded Arduino code collecting data every 1 to 5 min, averaging 30 samples, could significantly improve the sensor data.

- Testing signal transmission in WSN:

Fault sensors are not the sole cause of problems. For example, there are some reasons for transmission signal losses in WSN: sensor positions (as located near metal cabinets, a distance far from the gateway), sudden power failure, and Wi-Fi disconnection. However, if given guidance, users could know how to check this and troubleshoot.

- Embedded machine learning to faults detection:

The relevance of sensor nodes in the network indicated the potential development of tools that automatically diagnose errors. For example, the temperature sensors are located

on the wall to map heat in a room, contributing to thermal models and HVAC control strategies. This study presented the relationship between the sensors' temperature around the walls, HVAC's set-point temperature, and outdoor temperature (Figure 9).

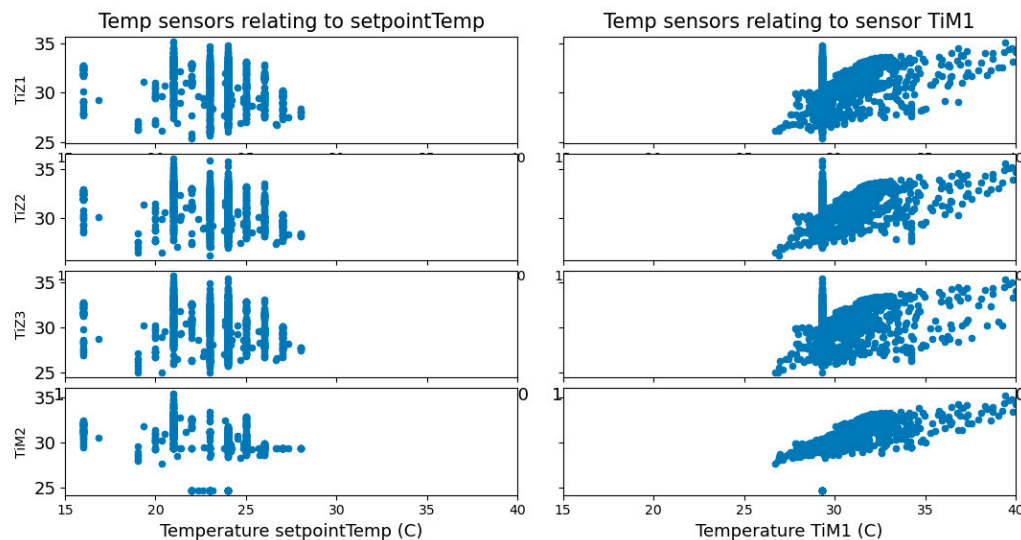

**Figure 9.** Relationship of temperature sensors, outdoor temperature, and HVAC's set-point.

The virtual temperature sensor model developed by a machine learning technique could work in parallel with a physical sensor to detect outlier data and maintain control in case of physical sensor failure, for example, the linear regression model of the temperature sensor on the western wall (TiM1) based on the sensor data (TiZ1, TiZ2, TiZ3, TiM2), HVAC setpoint temperature, and outdoor temperature. The model has a test score  $R^2$  of 0.599, with linear regression coefficients shown in Figure 10.

```
The test score R2: 0.599491630138733
The Linear Regression coefficients are
M1_features  linearRegr_Coefficients
0           TiZ1                -0.388014
1           TiZ2                 0.791656
2           TiZ3                -0.159574
3           TiM2                 0.383924
4           outTemp              0.253847
5           setpointTemp         -0.024090
```

**Figure 10.** Linear regression coefficients and test score  $R^2$  of TiM1 sensor.

**Maintenance issues:** Electrical equipment and monitoring system should be considered for operating buildings continuously and reliably. Monitoring data of equipment performance should provide warnings and help users participate in operating the system more efficiently.

- Monitoring the electrical device's performance:

The measurement data indicated in [7] could effectively assist users in decision-making regarding the use and maintenance of electrical equipment in the building. The planned maintenance and replacement are not close to reality, and work interruption may occur. In our buildings, electrical equipment often operates until it fails or has problems. This factor has received little attention but is prevalent in many buildings in Vietnam. For example, most lighting systems are old, designed over ten years, and have no changes when renovating the architectural and functional building. We recorded the working time of electric devices to estimate working performance. In Table 1, users could find out that group Led1 has minor performance (working time around 81 h/year), while groups Led2

and Led4 have the best (with working time around 4000 h/year). These data could support users' plans for maintenance devices (such as repairing or replacing them). We have found that energy saving can be achieved if the user applies information such as working time, capacity, the consumption of electrical appliances, and periodic reports.

**Table 1.** Working time and power consumption of Led groups in the year.

Group	Led1	Led2	Led3	Led4	Led5	Led6	Led7	Led8
Working time (hour/year)	81	4188	428	3966	2092	2093	1579	690
Consumption (Kwh/year)	2.1	110.1	11.3	104.3	55.2	55.2	41.8	18.3

- Monitoring for warnings:

Some display information is less noticeable but necessary to protect devices and maintenance—for example, sensor battery outages and the device's abnormality in power consumption. In addition, there are functions in Grafana that could set the alert thresholds and create email alerts for users automatically.

#### 4.3. Proposed Measurement Plans for Energy Efficiency

According to the authors of [24], information feedback from measurement systems is an effective way to influence and change behaviors. Therefore, the strategy combines measured data, and explaining users' behaviors will improve energy efficiency levels. Monitoring plans indicated significant energy savings that identify behaviors that need to be changed, interventions to solve the problem, and user benefits.

In our work, we focus on strategies to influence behaviors such as the energy consumed by electrical appliances, optimal energy control in buildings (microgrid), online sharing information (PV power generation, the voltage in connection node, electric demand, etc.) to local electrical managers for co-operation in exploiting PV energy resources, and contributing to power quality.

**Monitoring operation of equipment:** The survey of buildings and occupants will be effective in building renovation to reduce energy use [17]. Based on the building profile, we found only a switch to control the lighting system. This results in a waste of energy when lighting unnecessary areas; the water dispenser works 24 h per day. We proposed a solution by adding smart Wi-Fi actuators: the lighting system could be ON/OFF in eight groups (only turn on the lights in the working place); the water dispenser could be set on a schedule.

**Monitoring energy behaviors:** The relationship between user's behaviors and energy consumption could discover wasteful factors:

- Opening door behaviors and HVAC consumption.

For example, Table 2 shows a significant increase in HVAC average power by the door opening behavior in four summer months. In May, this value (0.978 kW) was more than two times that in June (0.547 kW), corresponding with the time period of opening within HVAC working (4.4% and 1.4%).

**Table 2.** Relationship of opening behavior and HVAC's consumption in five months.

Items	Duration HVAC Is on (Hour)	Opening-Time within HVAC Is on (Hour)	HVAC's Energy Use (kWh)	Average of HVAC's Power (kW)	Portion Time of Opening within HVAC Working
May-20	181.67	7.89	177.76	0.978	4.4%
Jun-20	360.8	4.9	197.4	0.547	1.4%
Jul-20	275	9.28	241.45	0.878	3.4%
Aug-20	155.67	6.05	138.98	0.893	3.9%
Sep-20	186.5	5.12	158.44	0.850	2.7%
Total	1159.7	33.3			



- HVAC set-point temperature ( $T_{\text{setpoint}}$ ) and HVAC consumption:

The monitoring system records user actions to control the air conditioning. Measurement data provide an understanding of the relationship between HVAC energy usage, occupant behaviors, estimates of energy use, or indoor temperatures for different occupant behavior.

In this study, the air conditioner capacity is designed for the office to ensure summer working conditions when the outdoor temperature is about  $35\text{ }^{\circ}\text{C}$  and the indoor  $T$  is only from  $27\text{ }^{\circ}\text{C}$  to  $29\text{ }^{\circ}\text{C}$ . Figure 11 shows the relationship between indoor and outdoor temperatures and HVAC power consumption during summer. The highest/lowest outdoor temperatures are  $39\text{ }^{\circ}\text{C}$  and  $22\text{ }^{\circ}\text{C}$ , while the highest/lowest indoor temperatures are  $36\text{ }^{\circ}\text{C}$  and  $26\text{ }^{\circ}\text{C}$ . Observing the summer months (May, June, July, and August) over 2 years, 2020–2021, the average set-point temperature value of the months fluctuates in the range of  $22\text{ }^{\circ}\text{C}$ – $25\text{ }^{\circ}\text{C}$ . However, the  $T_{\text{setpoint}}$  is a low fluctuation on a daily time scale. A  $T_{\text{setpoint}}$  value that does not change may be due to the user's habit and may potentially waste energy, while comfort is not guaranteed.

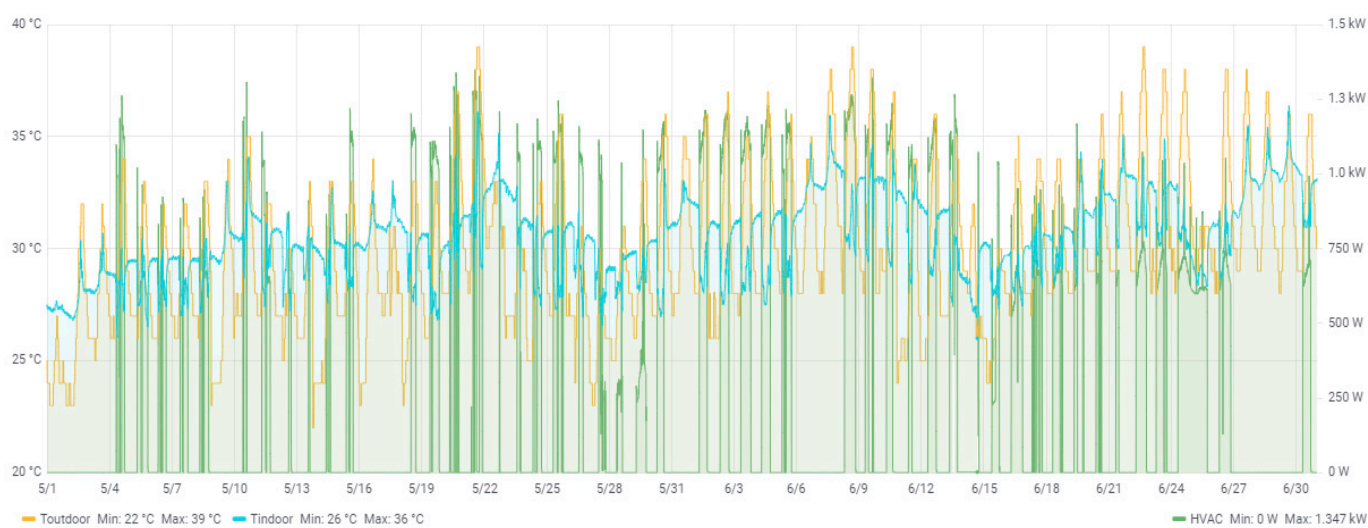

**Figure 11.** Relationship of HVAC consumption and indoor/outdoor temperature in 1 month.

We observed the energy consumption of the air conditioner for two days in July, the period from 7 am to 11 am. The doors were closed, and the air conditioner was turned on continuously during the time; one person was in the room.

In Figures 12 and 13, there is a similar outdoor temperature over 2 days: the average outdoor temperature ( $T_{\text{outdoor\_Avg}}$ ) =  $30\text{ }^{\circ}\text{C}$ ; on the first day,  $T_{\text{setpoint}} = 24\text{ }^{\circ}\text{C}$ ; on the second day,  $T_{\text{setpoint}} = 25\text{ }^{\circ}\text{C}$ .

The average power of the air conditioner on the first day ( $P_{\text{avg1}}$ ) equals 1053 W, 125 W higher than the average capacity of the air conditioner on the second day,  $P_{\text{avg2}} = 925\text{ W}$ . The average temperature in the room on the second day,  $T_{\text{indoor\_Avg2}} = 28\text{ }^{\circ}\text{C}$ ,  $1\text{ }^{\circ}\text{C}$  lower than the average temperature in the room on the first day. We found that setting a lower set-point temperature do not always increase comfort. Therefore, users should consider their habits in setting HVAC modes with HVAC consumption and comfort.

**Storage energy and self-consumption levels of buildings solar on the roof:** Maximal autonomous energy is essential for adapting demand and power supply capacity. Due to the cold winter weather in the north of Vietnam, air conditioners are almost unused, affecting self-consumption. We evaluate the on-site self-use based on the load matching indicators on different time scales (minute, hour, day, week, and month). For example, in the monthly timescale (September, October, and November) of 2021, the highest self-consumption rate was around 40%. However, in the daily timescale in Figure 14, these values have a substantial fluctuation of 10–80%, corresponding to 0.9–6.5 kWh.

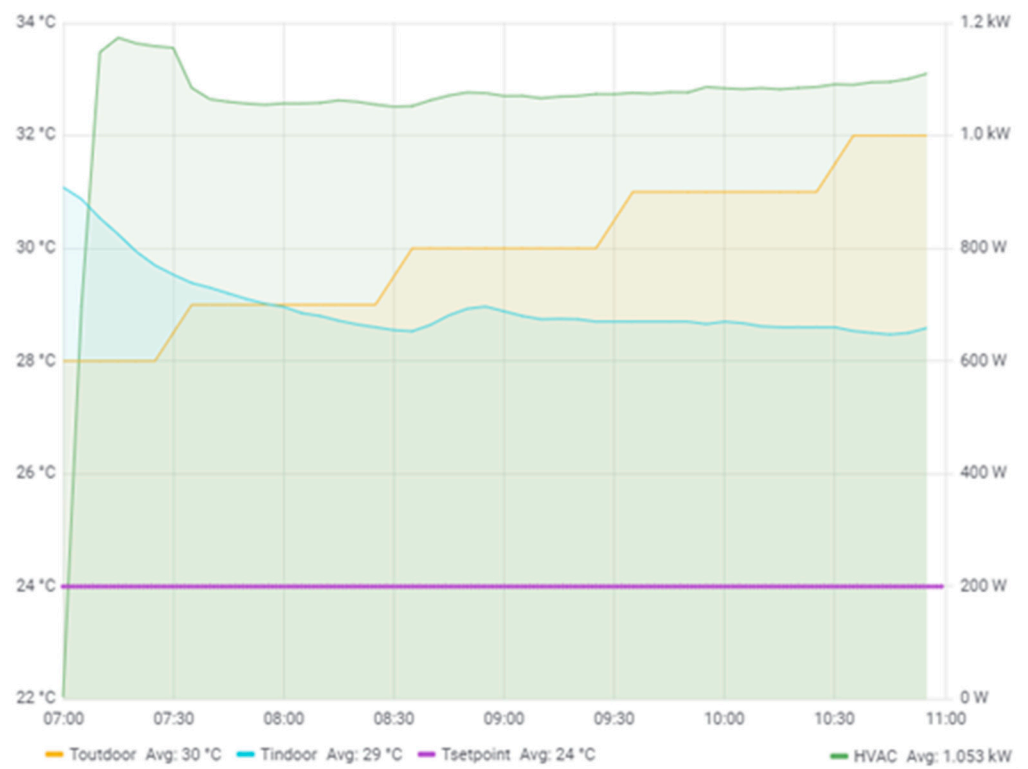

Figure 12. Experiment the first day (Tsetpoint = 24 °C).

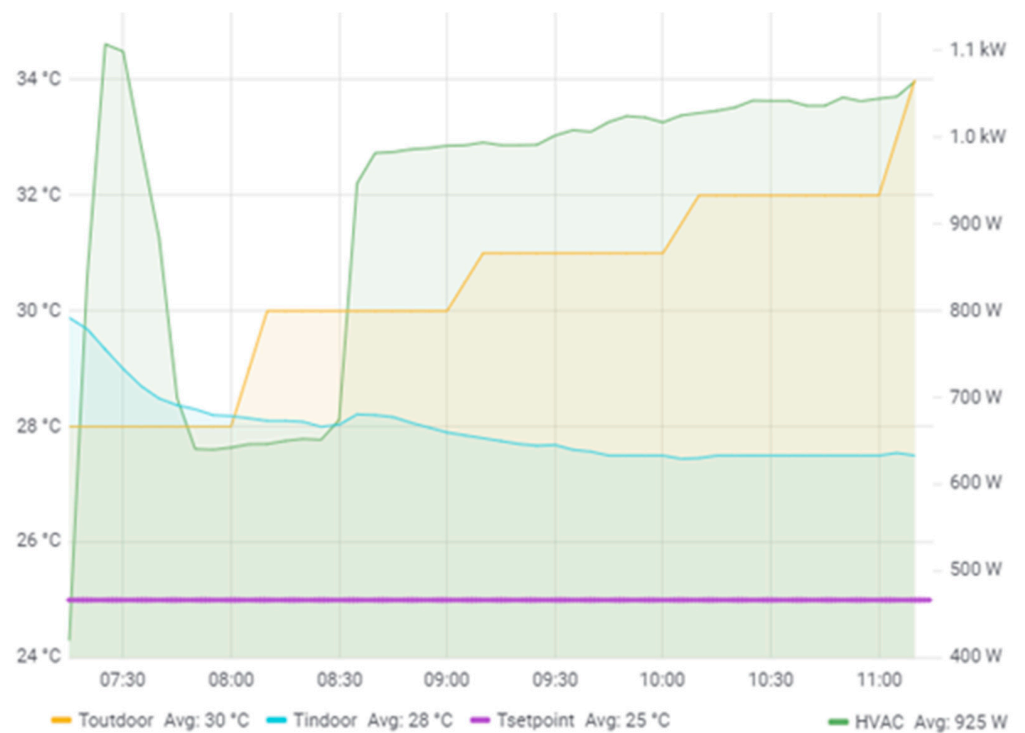
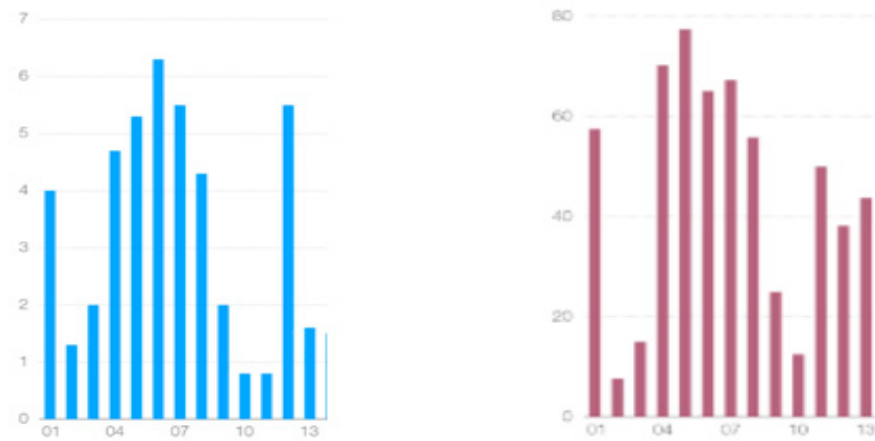
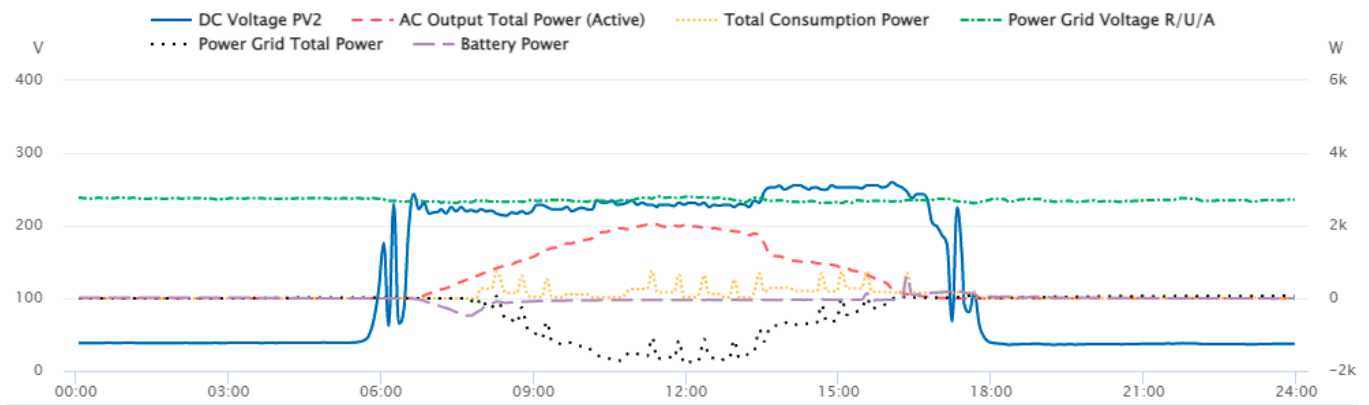

Figure 13. Experiment on the second day (Tsetpoint = 25 °C).



**Figure 14.** PV Production (kWh) (on the left) and self-consumption rate (%) (On the right) from 1 November 2021 to 13 November 2021.

We experimented with control energy strategies for two days in a minute timestamp. The idea is to note users' role in planning energy storage to improve the auto-consumption rate. In Figure 15, on 3 December 2021, the PV system produced 8.6 kWh, and the building used 2.2 kWh. Overall, the system generated a significant solar energy surplus. However, the battery discharged loads from 8 am to 4 pm due to insufficient solar energy. At 7 am and 6 pm, solar power provided charge to the battery, feed loads, and the grid. The building had a low self-consumption rate of 25% due to battery capacity reaching near 100% state of charge (SOC) before the critical period (at the peak PV generation).



**Figure 15.** Power flows through inverter on 3 December 2021.

Therefore, at this time, battery operation is inefficient. In Figure 16, users set up the battery operation modes for the day, ensuring the battery capacity had enough space to store electricity during the peak PV power generation. As a result, the self-consumption rate increased to 75%, limiting power backflow feed into the grid.

In terms of the steady state of voltage, there is a relationship between voltage and power at the connecting point. Overvoltage usually occurs when solar radiation is at peak value. During this time, PV systems feed more electrical energy into the grid than in the rest of the hours. We proposed an energy strategy based on the local control and incorporated storage sources. For example, the storage sources charge during overvoltage conditions and discharge during high load times on the grid.

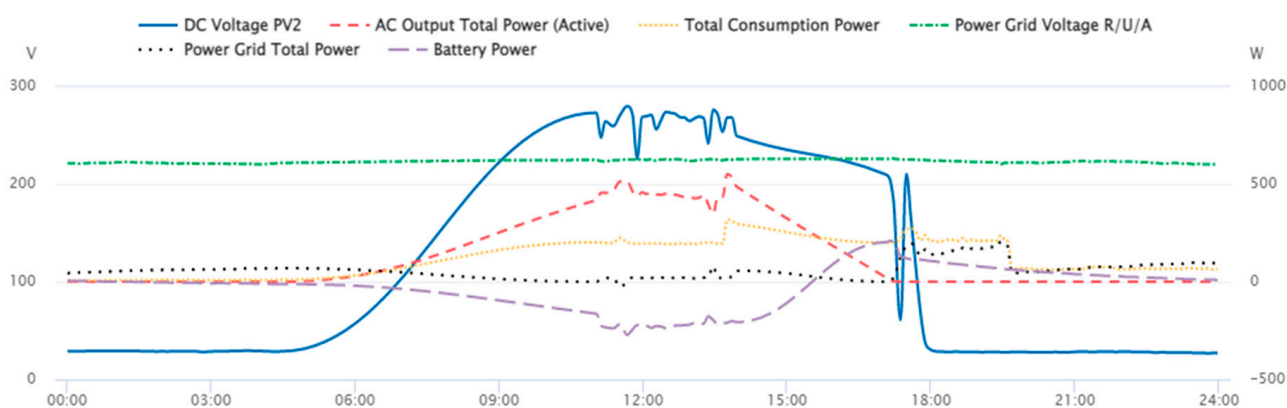

Figure 16. Power flows through inverter in 4 November 2021.

**Estimating energy efficiency:** After installing and operating the monitoring platform at VHH, we estimated the energy efficiency after one year:

- Survey data before project: The annual power consumption of electrical devices in the platform ( $E_i$ ) is about 5095 kWh/year; the price of electricity is applied for the Public College ( $P_e$ ): ~2000 VND/kWh.
- Data of the project: the investment budget of the monitoring system ( $I_v$ ): 15,000,000 (VND); electricity devices consumed ( $E_e$ ) 1941.05 kWh/year; the monitoring system consumed 69.33 kWh/year.

Energy saved ( $E_s$ ):

$$E_s = E_i - E_e = 3153.95 \text{ (kWh/year)} \quad (1)$$

Using Equation (1), we calculated a reduction in electricity bill per year ( $R_b$ ):

$$R_b = E_s * P_e = 6,307,900 \text{ (VND/year)} \quad (2)$$

Using Equation (1) and the cost  $E_i$ , the portion of saving energy ( $P_s$ ) is as follows:

$$P_s = (E_s/E_i) * 100\% = 62\% \quad (3)$$

If the annual maintenance and depreciation costs for the monitoring system are ignored, the payback period of the project ( $T_{\text{payback\_period}}$ ) can be approximated:

$$T_{\text{payback\_period}} = I_v/R_b = 2.38 \text{ (year)} \quad (4)$$

Our work shows that installing a monitoring system within the building's integrated rooftop PV source would help the owners to use energy efficiently and especially exploit energy to supply loads and maximum self-consumption of PV energy. As a result, we identified approximately 62% energy savings (3) and the monitoring system's payback period of approximately 2.38 years (4).

## 5. Discussions

Low-cost monitoring systems can help build a database on building characteristics and behaviors in Vietnam to provide information to planners, designers, and users. In this study, we have shown how users can mine measurement data and analyze it to detect user behavior points, building features for efficient energy strategies. From the available documents, the current surveillance technology trends and the approaching low-cost monitoring technology are as follows.

Sensor networks with different technologies can be deployed in a single monitoring platform with a customizable topology. Low cost and wireless connectivity allow for an increased number of measuring points to ensure that the necessary information is

collected. In addition, buildings can connect and share information to help improve use and management efficiency.

Users can improve data quality by simple testing solutions by applying data synthesis and analysis techniques to identify sensor problems and by being guided to diagnose the cause of some problems in sensor networks and to learn how to solve them. In addition to the access to commercial sensors for surveillance systems, there is a trend towards approaching open hardware and embedded programming for monitoring target development favored by the community. However, to do this, users require knowledge of programming and hardware.

In this paper, we note users in developing low-cost monitoring:

- There may be data errors from self-developed sensors' design and hardware coupling parts.
- Embedded programming could be a flexible solution to improve data quality. For instance, the sample rate can be adjusted and outlier values removed before sending data by functions.
- Some signal transmission problems from the sensor network could be detected and solved by low-skilled users.
- Data loss compensation by data fusion and ML techniques.

This study outlines a possible approach for citizens to develop monitoring systems in Vietnam's economic, user behavior, and energy contexts.

## 6. Conclusions

The novelty of this work provided practical guidelines to increase the feasibility of building monitoring systems. The low-cost monitoring system uses a wireless sensor network, which is easy to implement. Therefore, we could build a high-density sensor network to collect real-time data about users' activities, energy consumption of loads, and other building status factors. However, there are many challenges in sensor issues and WSNs. Therefore, we proposed several methods to improve data quality and system resiliency.

In this work, the building database orients energy-using behaviors in an effective direction. Furthermore, exploiting users' influences on energy consumption has often been considered based on the feedback information from the monitoring platform. However, user behaviors are very complex and volatile over time. Therefore, it requires more profound research that takes into account social factors.

Research results show that the system enables greater energy efficiency. In our platform, energy saving is up to 62%. This approach could improve users' energy awareness and motivate them to contribute to energy efficiency targets. In addition, a low-cost monitoring system can support building owners in joining the local energy community. The measured building data are essential for users and power managers to operate energy flow optimally, exchange energy between buildings in the area, maintain voltage stability, and benefit all parties involved in net-zero-energy buildings.

Our research has proved that a low-cost monitoring platform is suitable for the energy management of small and medium buildings. This research developed a low-cost monitoring system using a wireless sensor network and open-source software. Following this result, we can install massive sensor nodes to collect real-time data on user behaviors, energy consumption, and other building states. The system has measured and established analyzed database files, thereby detecting and orienting consumer behaviors to use energy efficiently while supporting optimal energy management control in the building.

The low-cost monitoring platform developed in this research shows that it was suitable in responding to expanding research on developing energy control and management strategies for buildings, especially ones with rooftop PV.

In our vision, this research is a cornerstone of long-term research on developing an advanced control system for building energy management at low cost, contributing to energy efficiency and renewable energy evolution in Vietnam.



**Author Contributions:** Conceptualization, T.T.H.V. and B.D.; Funding acquisition, D.Q.N. and B.D.; Investigation, T.T.H.V. and A.T.P.; Methodology, T.T.H.V. and B.D.; Project administration, V.C.B., D.Q.N. and B.D.; Resources, V.C.B.; Software, T.T.H.V. and A.T.P.; Supervision, B.D. and D.Q.N.; Writing—original draft, T.T.H.V.; Writing—review and editing, T.T.H.V., B.D., V.C.B. and D.Q.N.; All authors have read and agreed to the published version of the manuscript.

**Funding:** NVCC: NVCC31.03/22-22; USTH: USTH.EN02/22; Agence Nationale de la Recherche: MRSEI—2019—BREVES.

**Institutional Review Board Statement:** Not applicable.

**Informed Consent Statement:** Not applicable.

**Data Availability Statement:** Not applicable.

**Acknowledgments:** The author would like to thank the Energy management in Smart campus Project in 2020–2022, sponsored by Vietnam-Korea Vocational college of Hanoi city, Research project code USTH.EN.02/22 sponsored by Energy Department of University of Science and Technology of Hanoi, Research project code NVCC31.03/22-22 sponsored by Institute of Energy and science, VAST, and French National Research Agency (ANR) for supporting this work.

**Conflicts of Interest:** The authors declare no conflict of interest.

## References

- Further Advancing Energy Efficiency in High-Rise Residential and Commercial Buildings | UNDP in Viet Nam. Available online: <https://www.vn.undp.org/content/vietnam/en/home/presscenter/pressreleases/further-advancing-energy-efficiency-in-high-rise-residential-and.html> (accessed on 8 December 2021).
- Sanseverino, E.R.; Thuy, H.L.T.; Pham, M.H.; di Silvestre, M.L.; Quang, N.N.; Favuzza, S. Review of potential and actual penetration of solar power in Vietnam. *Energies* **2020**, *13*, 2529. [[CrossRef](#)]
- Decision of the Prime Minister No. 428/QĐ-TTg of 2016 on the Approval of the Revised National Power Development Master Plan for the 2011–2020 Period with the Vision to 2030 | ESCAP Policy Documents Management. Available online: <https://policy.asiapacificenergy.org/node/2760> (accessed on 15 December 2021).
- Văn Bản Quy Phạm Pháp Luật. Available online: [http://vanban.chinhphu.vn/portal/page/portal/chinhphu/hethongvanban?class\\_id=1&\\_page=1&mode=detail&document\\_id=199694](http://vanban.chinhphu.vn/portal/page/portal/chinhphu/hethongvanban?class_id=1&_page=1&mode=detail&document_id=199694) (accessed on 8 December 2021).
- Press Release on Rooftop Solar PV Development after 31 December 2020. Available online: <https://en.evn.com.vn/d6/news/Press-release-on-rooftop-solar-PV-development-after-31-December-2020-66-142-2111.aspx> (accessed on 8 December 2021).
- Decision No. 2074/DL-NLTT Dated 17 December 2020 of the Electricity and Renewable Energy Authority (under MOIT). Available online: <https://www.evn.com.vn/userfile/User/tcdl/files/VB2074guiEVNdethuchienvedMTMN.pdf> (accessed on 8 December 2021).
- Mobaraki, B.; Lozano-Galant, F.; Soriano, R.P.; Pascual, F.J.C. Application of Low-Cost Sensors for Building Monitoring: A Systematic Literature Review. *Buildings* **2021**, *11*, 336. [[CrossRef](#)]
- Delinchant, B.; A Dang, H.; Vu, H.T.T.; Nguyen, D.Q. Massive arrival of low-cost and low-consuming sensors in buildings: Towards new building energy services. *IOP Conf. Ser. Earth Environ. Sci.* **2019**, *307*, 012006. [[CrossRef](#)]
- Thanh, T.N.; Minh, P.V.; Trung, K.D.; Anh, T.D. Study on performance of rooftop solar power generation combined with battery storage at office building in northeast region, Vietnam. *Sustainability* **2021**, *13*, 11093. [[CrossRef](#)]
- Hong, T.T.V.; Delinchant, B.; Ferrari, J.; Nguyen, Q.D. Autonomous Electrical System Monitoring and Control Strategies to Avoid Oversized Storage Capacity. *IOP Conf. Ser. Earth Environ. Sci.* **2020**, *505*, 012045. [[CrossRef](#)]
- Fatima, S.; Püvi, V.; Lehtonen, M. Review on the PV Hosting Capacity in Distribution Networks. *Energies* **2020**, *13*, 4756. [[CrossRef](#)]
- Van Binh, D. Méthodes et Outils Pour le Dimensionnement Des Bâtiments et des Systèmes Énergétiques en Phase D'esquisse Intégrant la Gestion Optimale. 2017. Available online: <http://www.theses.fr/2016GREAT092> (accessed on 15 December 2021).
- Chatzigeorgiou, I.; Andreou, G. A systematic review on feedback research for residential energy behavior change through mobile and web interfaces. *Renew. Sustain. Energy Rev.* **2021**, *135*, 110187. [[CrossRef](#)]
- Lamberti, F.; Calderaro, V.; Galdi, V.; Graditi, G. Massive data analysis to assess PV/ESS integration in residential unbalanced LV networks to support voltage profiles. *Electr. Power Syst. Res.* **2017**, *143*, 206–214. [[CrossRef](#)]
- Nguyen, T.A.; Aiello, M. Energy intelligent buildings based on user activity: A survey. *Energy Build.* **2013**, *56*, 244–257. [[CrossRef](#)]
- Johansson, M.; Gentile, N.; Neij, L. Energy efficiency behaviour in the built environment—An assessment of current evaluation practices in the Nordic countries. *Energy Effic.* **2021**, *14*, 1–20. [[CrossRef](#)]
- Seabra, B.; Pereira, P.; Corvacho, H.; Pires, C.; Ramos, N. Low Energy Renovation of Social Housing: Recommendations on Monitoring and Renewable Energies Use. *Sustainability* **2021**, *13*, 2718. [[CrossRef](#)]
- Pereira, P.F.; Ramos, N.M.M.; Simões, M.L. Data-driven occupant actions prediction to achieve an intelligent building. *Build. Res. Inf.* **2019**, *48*, 485–500. [[CrossRef](#)]

19. Pereira, P.F.; Ramos, N.M.M. Influence of Occupant Behaviour on the State of Charge of a Storage Battery in a nearly-Zero Energy Building. *E3S Web Conf.* **2020**, *172*, 16010. [[CrossRef](#)]
20. Cristino, T.; Neto, A.F.; Wurtz, F.; Delinchant, B. Barriers to the adoption of energy-efficient technologies in the building sector: A survey of Brazil. *Energy Build.* **2021**, *252*, 111452. [[CrossRef](#)]
21. Vietnam—National Energy Efficiency Program 2019-2030 (English). Available online: <http://documents.worldbank.org/curated/en/598851561961183317/Vietnam-National-Energy-Efficiency-Program-2019--2030> (accessed on 29 May 2022).
22. Benoit, D.; Jérôme, F. *Standards and Technologies from Building Sector, IoT, and Open-Source Trends*; 62 Pages Chapter in Towards Energy Smart Homes—Algorithms, Technologies, and Applications; Ploix, S., Amayri, M., Bouguila, N., Eds.; Springer: Berlin/Heidelberg, Germany, 2021; ISBN 978-3-030-76476-0. Available online: [https://link.springer.com/chapter/10.1007/978-3-030-76477-7\\_3](https://link.springer.com/chapter/10.1007/978-3-030-76477-7_3) (accessed on 29 May 2022).
23. Bae, Y.; Bhattacharya, S.; Cui, B.; Lee, S.; Li, Y.; Zhang, L.; Im, P.; Adetola, V.; Vrabie, D.; Leach, M.; et al. Sensor impacts on building and HVAC controls: A critical review for building energy performance. *Adv. Appl. Energy* **2021**, *4*, 100068. [[CrossRef](#)]
24. Pereira, L.; Nunes, N. Understanding the practical issues of deploying energy monitoring and eco-feedback technology in the wild: Lesson learned from three long-term deployments. *Energy Rep.* **2020**, *6*, 94–106. [[CrossRef](#)]
25. Internet of Things: Wireless Sensor Networks White Paper. Available online: [https://www.academia.edu/36120041/Internet\\_of\\_Things\\_Wireless\\_Sensor\\_Networks\\_White\\_Paper](https://www.academia.edu/36120041/Internet_of_Things_Wireless_Sensor_Networks_White_Paper) (accessed on 8 December 2021).
26. Jesus, G.; Casimiro, A.; Oliveira, A. A Survey on Data Quality for Dependable Monitoring in Wireless Sensor Networks. *Sensors* **2017**, *17*, 2010. [[CrossRef](#)] [[PubMed](#)]
27. Low-Cost Sensors for the Measurement of Atmospheric Composition: Overview of Topic and Future Applications | Climate & Clean Air Coalition. Available online: <https://www.ccacoalition.org/en/resources/low-cost-sensors-measurement-atmospheric-composition-overview-topic-and-futur> (accessed on 8 December 2021).
28. Zaidan, M.A.; Motlagh, N.H.; Fung, P.L.; Lu, D.; Timonen, H.; Kuula, J.; Niemi, J.V.; Tarkoma, S.; Petaja, T.; Kulmala, M.; et al. Intelligent Calibration and Virtual Sensing for Integrated Low-Cost Air Quality Sensors. *IEEE Sens. J.* **2020**, *20*, 13638–13652. [[CrossRef](#)]
29. Sanchez-Sutil, F.; Cano-Ortega, A.; Hernandez, J.; Rus-Casas, C. Development and Calibration of an Open Source, Low-Cost Power Smart Meter Prototype for PV Household-Prosumers. *Electronics* **2019**, *8*, 878. [[CrossRef](#)]
30. A Beginner’s Guide to Uncertainty of Measurement Measurement Good Practice Guide. Available online: <https://www.academia.edu/26082525> (accessed on 8 December 2021).
31. Kleiboer, L.; Havinga, P. Calibration of sensors in sensor networks. In Proceedings of the 2005 IEEE Conference on Emerging Technologies and Factory Automation, Catania, Italy, 19–22 September 2005; pp. 519–526. [[CrossRef](#)]