



HAL
open science

SYMMETRIES OF $g|N$ -FOAMS

You Qi, Louis-Hadrien Robert, Joshua Sussan, Emmanuel Wagner

► **To cite this version:**

You Qi, Louis-Hadrien Robert, Joshua Sussan, Emmanuel Wagner. SYMMETRIES OF $g|N$ -FOAMS. 2023. hal-03998510

HAL Id: hal-03998510

<https://hal.science/hal-03998510>

Preprint submitted on 21 Feb 2023

HAL is a multi-disciplinary open access archive for the deposit and dissemination of scientific research documents, whether they are published or not. The documents may come from teaching and research institutions in France or abroad, or from public or private research centers.

L'archive ouverte pluridisciplinaire **HAL**, est destinée au dépôt et à la diffusion de documents scientifiques de niveau recherche, publiés ou non, émanant des établissements d'enseignement et de recherche français ou étrangers, des laboratoires publics ou privés.

SYMMETRIES OF \mathfrak{gl}_N -FOAMS

YOU QI, LOUIS-HADRIEN ROBERT, JOSHUA SUSSAN, AND EMMANUEL WAGNER

ABSTRACT. We give an action of a Lie subalgebra of the Witt algebra on foams. This action is compatible with the \mathfrak{gl}_N -foam evaluation formula. In particular, this endows state spaces associated with \mathfrak{gl}_N -webs with an \mathfrak{sl}_2 -action. When working in positive characteristic, this can be used to define a p -DG structure on these state spaces.

CONTENTS

1. Introduction	1
1.1. Outline	2
1.2. Acknowledgments	3
Conventions	3
2. Topological preliminaries	4
2.1. Webs and foams	4
2.2. \mathfrak{gl}_N -foams evaluation	7
2.3. New decorations	8
2.4. Euler characteristics of surfaces	9
2.5. \mathfrak{gl}_N -state spaces	12
2.6. Base change	15
3. Algebraic preliminaries	15
3.1. Symmetries of foam evaluations	15
3.2. Smash products	16
3.3. p -DG structure	17
3.4. One-half of the Witt algebra	18
3.5. Twists	20
4. Action on foams	21
4.1. Action of one-half of the Witt algebra	21
4.2. Action of \mathfrak{sl}_2	27
4.3. p -DG structure	29
4.4. Saddles	31
4.5. Related work	32
References	32

1. INTRODUCTION

The quest to categorify Witten–Reshetikhin–Turaev (WRT) invariants [Wit89, RT91] of 3-manifolds has been active for many years [CF94]. The first major and promising step was accomplished by Khovanov [Kho00] where he defined a categorification of the Jones polynomial, now known as Khovanov homology. This link homology theory led to many applications in low-dimensional topology. Since

the discovery of Khovanov homology, many other link homologies have been constructed: Heegaard–Floer homology [OS04, Ras03], \mathfrak{gl}_N -homology, triply-graded HOMFLY-PT homology [KR08a, KR08b, Kho07, Rou17], etc.

The WRT invariants of a 3-manifold M are typically defined as certain linear combinations of quantum link invariants (Reshetikhin–Turaev invariants) of a link presenting the manifold M as a surgery on S^3 evaluated at a root of 1.

This raises the challenge of making sense of “*categorification at root of 1*”. A strategy has been suggested by Khovanov [Kho16] where he introduced p -complexes for p a prime number. This was developed later in various works [KQ15, Qi14, QS17, EQ16] leading eventually to a categorification of the Jones polynomial [QS20] and of the colored Jones polynomial [QRSW21] at prime roots of unity. Both these constructions are based on a new categorification of the Jones polynomial introduced by [Cau17] whose definition is closely related to that of triply-graded link homology and therefore to Soergel bimodules.

A key feature in categorification at prime roots of 1 is to show that these link homologies carry additional algebraic structures (p -DG structures or H -module structures where $H = \mathbb{k}[\partial]/(\partial^p)$). This allows one to work in the stable category of graded H -modules whose Grothendieck group is

$$\mathbb{Z}[q, q^{-1}]/(1 + q^2 + \cdots + q^{2p-2}).$$

In other words, this category is a categorical incarnation of the arithmetic of $\mathbb{Z}[e^{\pi i/p}]$. We refer to the introductions of [QS20, QRSW21] for a more detailed account.

Even more structure has been found on triply-graded homology [KR16] in the form of an action of the positive half of the Witt algebra. In a similar vein, an action of \mathfrak{sl}_2 was constructed on Soergel bimodules [EQ20]. Building upon [KQ15], Khovanov extended the p -differential on nilHecke algebras (in characteristic p) to a half-Witt action on nilHecke algebras, and more general KLR algebras in characteristic 0 [Kho12]. He suggested that these actions may extend to actions on link homologies which could explain various observed symmetries. In a related but different direction, Beliakova and Cooper noticed that in characteristic p there is an action of the Steenrod algebra on nilHecke algebras and that one could recover the p -DG structure on these algebras from this point of view [BC18]. Finally, the operator ∇ constructed by Wang in [Wan21] can be seen as a (part of) the \mathfrak{sl}_2 action described in the present paper.

The aim of this paper is to show that these algebraic structures also show up in the TQFT functors used to define the original categorification of the Jones polynomial (actually its equivariant version, as defined by two of the authors of this paper [RW20a]) and in the \mathfrak{gl}_N generalizations. In other words, we put the previous studies of p -DG structures on link homology [QS20, QRSW21] into the framework of investigating (infinitesimal) symmetries of foam evaluations. We tried to maintain as much flexibility as possible to allow usage of the construction in this paper in a large variety of contexts. This explains the presence of parameters in the actions we define. The statement about the action of a half of the Witt algebra is phrased in Theorem 4.4 and Proposition 4.11. An \mathfrak{sl}_2 -action is given in Propositions 4.7 and 4.12. The p -DG structure is presented in Propositions 4.9 and 4.13.

The construction is based on foams, which also makes sense in the context of Soergel bimodules. Thus the structure we exhibit here specializes to that in [EQ20] and [KR16].

A forthcoming paper [QRSW22] will implement part of these structures at the level of link homologies.

1.1. Outline. The remainder of the paper is organized as follows.

- Section 2 gives a self-contained account of \mathfrak{gl}_N -webs and foams, a recollection of the foam evaluation formula, a discussion of how to compute Euler characteristics of surfaces, and a definition of \mathfrak{gl}_N -state spaces.
- Section 3 presents the Witt Lie algebra \mathfrak{W} as well as \mathfrak{W}_{-1}^∞ , a half of \mathfrak{W} and describes its action on polynomial rings. It also explains how \mathfrak{sl}_2 embeds in this algebra, and how this can be used to define p -DG-structures.
- Section 4 defines the action of \mathfrak{W}_{-1}^∞ on foams, giving rise to \mathfrak{sl}_2 and p -DG-structures. The section concludes with relations to related actions already occurring in the literature.

1.2. Acknowledgments. We would like to thank Lev Rozansky, Ben Elias and Joshua Wang for interesting and enlightening conversations and to point to [Wan21] and [Eli21] as sources of inspiration.

We especially would like to thank Mikhail Khovanov who encouraged us to search for Witt algebra actions on foams.

The ideas of the present paper were already implicitly used in [QRSW21]. The relevance of formalizing them became apparent during the hybrid workshop ‘‘Foam Evaluation’’ held at ICERM organized by one of the authors, Mikhail Khovanov, and Aaron Lauda.

Some figures are recycled from papers of various subsets of the authors with or without other collaborators.

Y. Q. is partially supported by the Simons Foundation Collaboration Grants for Mathematicians. J.S. is partially supported by the NSF grant DMS-1807161. Y. Q. and J. S. thank the Université Paris Cité and its Programme d’invitations internationales scientifiques for their hospitality. L.H.R. was partially supported by the Luxembourg National Research Fund PRIDE17/1224660/GPS. E.W. is partially supported by the ANR projects AlMaRe (ANR-19-CE40-0001-01), AHA (JCJC ANR-18-CE40-0001) and CHARMS (ANR-19-CE40-0017).

CONVENTIONS

Pardon our French, \mathbb{N} stands for the set of non-negative integers. Foams are read from bottom to top. We set $\mathbb{N}_{-1} = \{k \in \mathbb{Z}, k \geq -1\}$. For a ring with unity \mathbb{k} , and for $x \in \mathbb{k}$, we set $\bar{x} = 1 - x$.

The algebras $R_N = \mathbb{Z}[X_1, \dots, X_N]^{S_N}$ and $\mathbb{k}_N = \mathbb{k}[X_1, \dots, X_N]^{S_N}$ will play central roles in this paper. They are non-negatively graded by imposing that $\deg(X_i) = 2$. The i th elementary, complete homogeneous, and power sum symmetric polynomials in X_1, \dots, X_N are denoted by E_i , H_i and P_i respectively, so that

$$R_N = \mathbb{Z}[E_1, \dots, E_N] \quad \text{and} \quad \mathbb{k}_N = \mathbb{k}[E_1, \dots, E_N].$$

For $a \in \mathbb{N}$, Sym_a denotes the ring of symmetric polynomials in a variables with \mathbb{Z} coefficients, in particular $R_N = \text{Sym}_N$. When working in such a ring, we will let e_i, h_i and p_i be the i th elementary, complete homogeneous, and power sum symmetric polynomials respectively without reference to the variables. The ring Sym_a is graded by imposing the e_i is homogeneous of degree $2i$. With this setting, we have:

$$\deg(e_i) = \deg(h_i) = \deg(p_i) = 2i.$$

For $n \in \mathbb{Z}$, we let $[n] = \frac{q^n - q^{-n}}{q - q^{-1}}$, for $k \in \mathbb{N}$, we let $[k]! = \prod_{j=1}^k [j]$. Finally, for $m \in \mathbb{Z}$ and $a \in \mathbb{N}$, define:

$$\begin{bmatrix} m \\ a \end{bmatrix} = \prod_{i=1}^a \frac{[m+1-i]}{[i]}.$$

Note that if m is non-negative, one has $\begin{bmatrix} m \\ a \end{bmatrix} = \frac{[m]!}{[a]![m-a]!}$.

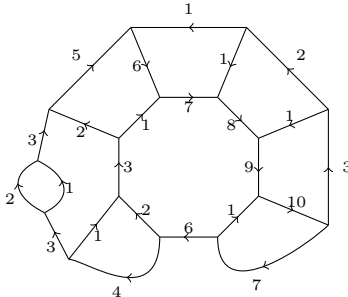
FIGURE 1. Example of a web in \mathbb{R}^2 .

For a \mathbb{Z} -graded vector space V , let V_i denote the subspace in degree i . Let $q^n V$ denote the \mathbb{Z} -graded vector space where $(q^n V)_i = V_{i-n}$.

2. TOPOLOGICAL PRELIMINARIES

2.1. Webs and foams.

Definition 2.1. Let Σ be a surface. A *closed web* or simply a *web*¹ is a finite, oriented, trivalent graph $\Gamma = (V(\Gamma), E(\Gamma))$ embedded in the interior of Σ and endowed with a *thickness function* $\ell: E(\Gamma) \rightarrow \mathbb{N}$ satisfying a flow condition: vertices and thicknesses of their adjacent edges must be one of these two types:

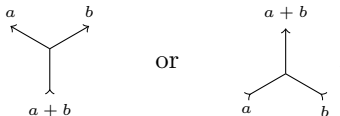

The first type is called a *split* vertex, the second a *merge* vertex. In each of these types, there is one *thick* edge and two *thin* edges. Oriented circles with non-negative thickness are regarded as edges without vertices and can be part of a web. The embedding of Γ in Σ is smooth outside its vertices, and at the vertices should fit with the local models above.

The surfaces we will be interested in are \mathbb{R}^2 and $\mathcal{A} = \{(x, y) \in \mathbb{R}^2, 1 \leq |x|^2 + |y|^2 \leq 2\} \simeq \mathbb{S}^1 \times [0, 1]$. In the latter case, we require that the web is *directed*, meaning that the projection map $\pi: \Gamma \rightarrow \mathbb{S}^1$ preserves orientation locally. Such webs are called *vinyl graphs*.

Remark 2.2. There are neither sources nor sinks in a web. A web is not necessarily connected.

Definition 2.3. Let M be an oriented smooth 3-manifold with a collared boundary. A *foam* $F \subset M$ is a collection of *facets*, that are compact oriented surfaces labeled with non-negative integers and glued together along their boundary points, such that every point p of F has a closed neighborhood homeomorphic to one of the following:

- (1) a disk, when p belongs to a unique facet,
- (2) $Y \times [0, 1]$, where Y is the neighborhood of a merge or split vertex of a web, when p belongs to three facets,
- (3) the cone over the 1-skeleton of a tetrahedron with p as the vertex of the cone (so that it belongs to six facets).

¹Such a graph is sometimes referred to as a *MOY graph*, but we will use the more commonly used term of *web*.

See Figure 2 for a pictorial representation of these three cases. The set of points of the second type is a collection of curves called *bindings* and the points of the third type are called *singular vertices*. The *boundary* ∂F of F is the closure of the set of boundary points of facets that do not belong to a binding. It is understood that F coincides with $\partial F \times [0, 1]$ on the collar of ∂M . For each facet f of F , we denote by $\ell(f)$ its label, called the *thickness* of f . A foam F is *decorated* if each facet f of F is assigned a symmetric polynomial $P_f \in \text{Sym}_{\ell(f)}$. In the second local model 2, it is implicitly understood that thicknesses of the three facets are given by that of the edges in Y . In particular it satisfies a flow condition and locally one has a thick facet and two thin ones. We also require that orientations of bindings are induced by that of the thin facets and by the opposite of the thick facet. Foams are regarded up to ambient isotopy relative to boundary. Foams without boundary are said to be *closed*.

Remark 2.4.

- Diagrammatically, decorations on facets are depicted by dots placed on facets adorned with symmetric polynomials in the correct number of variables (the thickness of the facet they sit on). The decoration of a given facet is the product of all adornments of dots sitting on that facet.
- Decorations will be slightly generalized a bit later. See Section 2.3 and Convention 2.15.

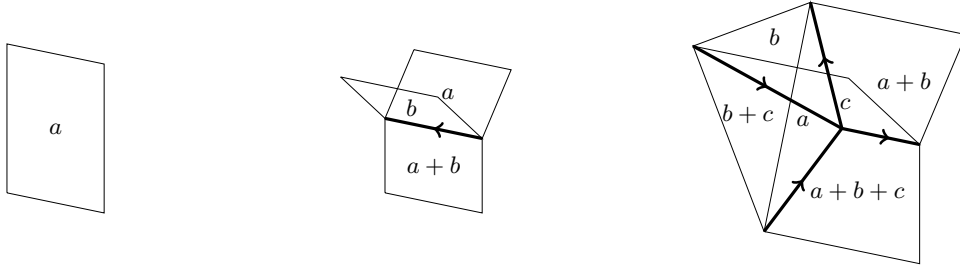

FIGURE 2. The three local models of a foam. Taking into account the thicknesses, the model in the middle is denoted $Y^{(a,b)}$, and the model on the right is denoted $T^{(a,b,c)}$.

The 3-manifolds in which we will consider foams are \mathbb{R}^3 , $\mathbb{R}^2 \times [0, 1]$ and $\mathcal{A} \times [0, 1]$.

Notation 2.5. For a foam F , we write:

- F^2 for the collection of facets of F ,
- F^1 for the collection of bindings,
- F^0 for the set of singular vertices of F .

We partition F^1 as follows: $F^1 = F^1_{\circ} \sqcup F^1_{_}$, where F^1_{\circ} is the collection of circular bindings and $F^1_{_}$ is the collection of bindings diffeomorphic to intervals. If $s \in F^1_{_}$, any of its points has a neighborhood diffeomorphic to $Y^{(a,b)}$ for a given a and b , and we set:

$$(1) \quad \deg_N(s) = ab + (a+b)(N - a - b).$$

If $v \in F^0$, it has a neighborhood diffeomorphic to $T^{(a,b,c)}$ and we set:

$$(2) \quad \deg_N(v) = ab + bc + ac + (a+b+c)(N - a - b - c).$$

Definition 2.6. Let F be a decorated foam and suppose that all decorations are homogeneous. For all N in \mathbb{N} , the N -degree of F is the integer $\deg_N(F) \in \mathbb{Z}$ given

by the following formula:

$$(3) \quad \deg_N(F) := \sum_{f \in F^2} \left(\deg(P_f) - \ell(f)(N - \ell(f))\chi(f) \right) + \sum_{s \in F^1_-} \deg_N(s) - \sum_{v \in F^0} \deg_N(v).$$

The reader may want to wait until Remark 2.12 to see a better approach to calculating the N -degree in the case of foams with trivial decorations.

The boundary of a foam $F \subset M$ is a web in ∂M . In the case $M = \Sigma \times [0, 1]$ is a thickened surface, a generic section $F_t := F \cap (\Sigma \times \{t\})$ is a web. The bottom and top webs F_0 and F_1 are called the *input* and *output* of F respectively.

If Σ is a surface, \mathbf{Foam}_Σ is the category which has webs in Σ as objects and $\text{Hom}_{\mathbf{Foam}_\Sigma}(\Gamma_0, \Gamma_1) = \{\text{decorated foams } F \text{ in } \Sigma \times [0, 1] \text{ with } F_i = \Gamma_i \text{ for } i \in \{0, 1\}\}$.

Composition is given by stacking foams on one another and rescaling. Decorations behave multiplicatively. The identity of Γ is $\Gamma \times [0, 1]$ decorated by the constant polynomial 1 on every facet. The N -degree of foams is additive under composition. If Γ is a web in a surface Σ and $h : \Sigma \times [0, 1] \rightarrow \Sigma$ is a smooth isotopy² of Σ , one can define the foam $F(h)$ to be the trace of $h(\Gamma)$ in $\Sigma \times [0, 1]$: for all $t \in [0, 1]$, $F(h)_t = h_t(\Gamma)$. Such foams are called *traces of isotopies*. They have degree 0.

Definition 2.7. A foam in a surface $\Sigma \times [0, 1]$ is *basic* if it is a trace of isotopy or if it is equal to $\Gamma \times [0, 1]$ outside a cylinder $B \times [0, 1]$, and where it is given inside by one of the local models given in Figure 3.

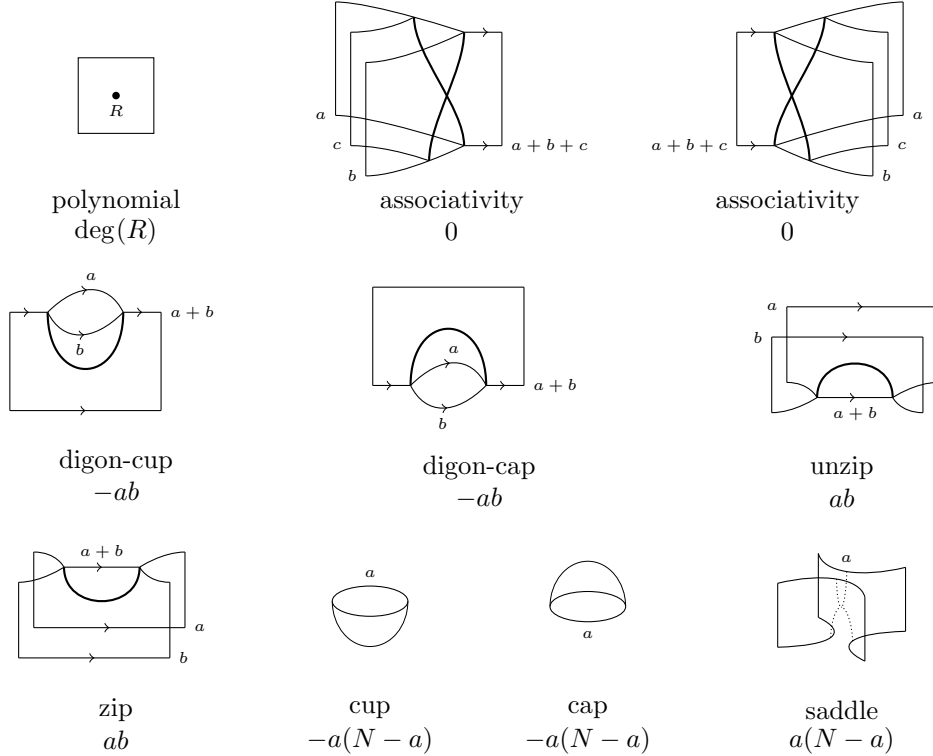

FIGURE 3. The degree of a basic foam is given below the name of each of the local models.

²For the sake of satisfying the collared condition, one should assume that $h_t = \text{Id}_\Sigma$ for $t \in [0, \epsilon \cup] 1 - \epsilon, 1]$ for an $\epsilon \in]0, 1[$.

A foam in $\Sigma \times [0, 1]$ is *in good position* if it is a composition of basic foams. A foam in $\Sigma \times [0, 1]$ is *spherical* if it is isotopic to a foam in good position for which the saddle model is not used.

If Γ is a web in \mathbb{R}^2 , we denote by $V(\Gamma)$ the free \mathbb{k} -module generated by foams in good position in $\mathbb{R}^2 \times [0, 1]$ with \emptyset as input and Γ as output.

Remark 2.8. Every foam in $\Sigma \times [0, 1]$ is isotopic to a foam in good position, however, not every foam is spherical.

Convention 2.9. If a foam is both spherical and in good position, we assume that no saddle appears in its decomposition as a composition of basic foams.

2.2. \mathfrak{gl}_N -foams evaluation. In this subsection we briefly summarize the \mathfrak{gl}_N -foam evaluation introduced in [RW20a].

For the rest of this section, we fix N indeterminates X_1, \dots, X_N . The elements of $\mathbb{P} := \{1, \dots, N\}$ are called *pigments*. A \mathfrak{gl}_N -coloring c of a foam F is a map $c: F^2 \rightarrow \mathcal{P}(\mathbb{P})$, where \mathcal{P} stands for powerset. It should satisfy the following two conditions:

- (a) for each facet $f \in F^2$, $\#c(f) = \ell(f)$,
- (b) around each binding, $c(f_{\text{thick}}) = c(f_1) \cup c(f_2)$, where f_{thick} denotes the thick facet and f_1 and f_2 the thin facets at this binding.

Given F , a decorated closed foam, and c a \mathfrak{gl}_N -coloring of F , the *colored \mathfrak{gl}_N -evaluation of (F, c)* is the rational function in variables X_1, \dots, X_N defined by:

$$(4) \quad \langle F, c \rangle_N := (-1)^{s(F, c)} \frac{P(F, c)}{Q(F, c)}$$

with

$$(5) \quad P(F, c) := \prod_{f \in F^2} P_f(\underline{X}_{c(f)}) \quad \text{and}$$

$$(6) \quad Q(F, c) := \prod_{1 \leq i < j \leq N} (X_i - X_j)^{\chi(F_{ij}(c))/2},$$

and where we have the following.

- $P_f(\underline{X}_{c(f)})$ is the evaluation of the polynomial P_f in the indeterminates $\underline{X}_{c(f)} := \{X_i | i \in c(f)\}$.
- $F_{ij}(c)$ is the surface formed by facets f in F^2 whose colors $c(f)$ contain either i or j but not both. This surface is called the *bichrome surface of (F, c) associated with (i, j)* ,
- $s(F, c)$ is the integer given by the following formula:

$$(7) \quad s(F, c) = \sum_{i=1}^N \frac{i\chi(F_i(c))}{2} + \sum_{1 \leq i < j \leq N} \theta_{ij}^+(F, c),$$

where we have the following.

- $\theta_{ij}^+(F, c)$ counts the number of circles separating i -pigmented and j -pigmented regions in $F_{ij}(c)$ which are positive. This means that the orientation of the circle and the relative position of the i -pigmented and j -pigmented regions are locally given by the local model:

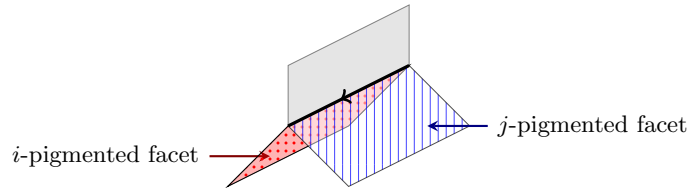

- $F_i(c)$ is the surface formed by facets f in F^2 whose colors $c(f)$ contain i . These surfaces are called *monochrome surfaces of (F, c) associated with i* .

Note that the symmetric group S_N on N letters acts both on the set of colorings of F (by permuting the pigments) and on the ring of rational fractions in variables X_1, \dots, X_N . The colored evaluation intertwines these two actions as stated by next lemma.

Lemma 2.10 ([RW20a, Lemma 2.17]). *If $\sigma \in S_N$, then*

$$(8) \quad \langle F, \sigma \cdot c \rangle_N = \sigma \cdot \langle F, c \rangle_N.$$

Finally define the \mathfrak{gl}_N -evaluation of a foam F by:

$$(9) \quad \langle F \rangle_N := \sum_c \langle F, c \rangle_N,$$

where the sum runs over all \mathfrak{gl}_N -colorings of F .

Proposition 2.11 ([RW20a, Proposition 2.19]). *For any decorated closed foam, $\langle F \rangle_N$ is a symmetric polynomial in X_1, \dots, X_N . If decorations are homogeneous,*

$$\deg(\langle F \rangle_N) = \deg_N(F).$$

Remark 2.12 ([RW20a, Lemma 2.15]). (1) Let F be a (not-necessarily closed) foam with trivial decoration and c a coloring of F . The following identity holds

$$(10) \quad \deg_N(F) = - \sum_{1 \leq i < j \leq N} \chi(F_{ij}(c)).$$

- (2) Note that contrary to [BN05, Definition 6.2] or [QR16, Definition 3.1], the formula (10) only involves Euler characteristic of surfaces and has no contribution from webs on the boundary. This is because we chose only to work with closed webs, for which these contributions vanish.

2.3. New decorations. For our purposes it will be convenient to have decorations of a new type. In formula (4), the decoration of a facet is evaluated on variables corresponding to pigments in the color of the facet. This is equivalent to saying that one has the following local relation on the evaluation:

$$(11) \quad \left\langle \begin{array}{c} \square \\ \bullet \\ R \end{array}, c \right\rangle_N = R(\underline{X}_{c(f)}) \left\langle \begin{array}{c} \square \\ \square \end{array}, c \right\rangle_N,$$

where f denotes the facet decorated by R .

Following [ETW18], one can also introduce decorations which are polynomials to be evaluated on variables corresponding to pigments that are not in the color of that facet. Although we gain flexibility with this new decoration, it does not affect the result from the previous subsection, as we shall explain below. If f is a facet in a foam F and c is a coloring of F , let $\widehat{c}(f)$ be the complement of $c(f)$ in \mathbb{P} .

Lemma 2.13. *The colored evaluation satisfies the following local relation:*

$$(12) \quad (-1)^{(N-a)(N-a+1)/2} \left\langle \begin{array}{c} \square \\ \circlearrowleft \\ R \end{array}, c \right\rangle_N = R(\underline{X}_{\widehat{c}(f)}) \left\langle \begin{array}{c} \square \\ \square \\ a \end{array}, c \right\rangle_N,$$

where:

- we have abused notation and let c be the coloring on both sides, (this is legitimate since there is a canonical 1-to-1 correspondence between the set of \mathfrak{gl}_N -colorings of the foams on both sides);
- f is the facet with thickness a in both diagrams;
- the hashed facet on the left-hand side has thickness N .

Proof. This follows directly from formula (4). Let us denote by F and G the foam on the left-hand side and the on the right-hand side of (12) respectively. Only the sign discussion is not trivial. By Lemma 2.10, one can suppose that the bubble is colored by $\{1, \dots, N - a\}$. In that case, $\theta_{ij}^+(F) = \theta_{ij}^+(G)$ for all i, j and

$$(13) \quad \chi(F_i(c)) = \begin{cases} \chi(G_i(c)) + 2 & \text{if } 1 \leq i \leq N - a, \\ \chi(G_i(c)) & \text{if } N - a + 1 \leq i \leq N. \end{cases} \quad \square$$

Remark 2.14. In Lemma 2.13, if the “bubble” were glued on the other side, the formula would have an extra $(-1)^{a(N-a)}$ factor. This is because, keeping the same notations as in the proof, one would have

$$(14) \quad \theta_{ij}^+(F, c) = \begin{cases} \theta_{ij}^+(G, c) + 1 & \text{if } 1 \leq i \leq N - a \text{ and } N - a + 1 \leq j \leq N, \\ \theta_{ij}^+(G, c) & \text{otherwise.} \end{cases}$$

This trick of using bubbles was already used in [RW20a] to write down the formula for the neck-cutting relation.

Lemma 2.13 allows us to make sense of new kinds of decorations on facets. A decoration of a facet f of thickness a can now be a product of a symmetric polynomial in a variables (as before) with a symmetric polynomial in $N - a$ variables, or a sum of such expressions. In other words, a decoration of a facet f of thickness a is an element P_f of $\mathbb{k}[x_1, \dots, x_N]^{S_a \times S_{N-a}} \cong \mathbb{k}[x_1, \dots, x_a]^{S_a} \otimes \mathbb{k}[x_1, \dots, x_{N-a}]^{S_{N-a}}$. The formula for $P(F, c)$ becomes:

$$(15) \quad P(F, c) := \prod_{f \in F^2} P_f(\underline{X}_{c(f)}, \underline{X}_{\widehat{c}(f)})$$

where $P_f(\underline{X}_{c(f)}, \underline{X}_{\widehat{c}(f)})$ is the evaluation of P_f on $\underline{X}_{c(f)}$ for the first $a = \ell(f)$ variables and $\underline{X}_{\widehat{c}(f)}$ for the last $N - a$ variables.

Proposition 2.11 remains valid with these more general decorations, since one can see these decorations as shortcuts for foams with extra decorated glued bubbles as explained by Lemma 2.13.

Convention 2.15. From now on, decorations of foams are of this more general form.

2.4. Euler characteristics of surfaces. A key ingredient in formula (4) giving the colored \mathfrak{gl}_N -evaluation is the Euler characteristic of bichrome surfaces. In this subsection, we inspect how this quantity can be computed for foams in good position. We will as well consider monochrome surfaces. Let us fix a surface Σ and consider a colored foam (F, c) in $\Sigma \times [0, 1]$. Suppose furthermore that F is in good position and as such is a composition of $F^{(1)}, \dots, F^{(\ell)}$. We say that $F^{(k)}$, a basic foam which is not the trace of an isotopy, *involves* a pigment i if i belongs to the color of at least one of the facets in the non-trivial part of $F^{(k)}$.

Lemma 2.16. *Let F be a spherical closed foam in good position, and c a \mathfrak{gl}_N -coloring of F . For any pigment i , the number of cups involving i equals the number of caps involving i .*

Proof. Since F is in good position, the projection π onto $[0, 1]$ provides a Morse function. Since F is spherical, the surface $F_i(c)$ contains no critical point for π

of index 1, hence the number of maxima is equal to the number of minima. This implies the number of cups equals the number of caps. \square

Consider a closed foam in good position F , and c a \mathfrak{gl}_N -coloring c of F . Fix $i < j$ two pigments. Since F is in good position, we can present the bichrome surface $F_{ij}(c)$ as a movie. Traces of isotopies pieces of F correspond to isotopies in the movie of $F_{ij}(c)$ and so there are many basic foams for which nothing really happens in $F_{ij}(c)$. In Table 1, we gather the interesting pieces of F and translate them into (movie) Morse moves for $F_{ij}(c)$. Additionally, we make explicit the local contributions of these various pieces to $\chi(F_{ij}(c))$. Finally, the last column of the table gives notation to the number of basic foams of each particular type in (F, c) : $Z_{ij}, Z_{ji}, Y_{ij}, Y_{ji}, V_{ij}, V_{ji}, \Lambda_{ij}, \Lambda_{ji}, U_{ij}, U_{ji}, A_{ij}, A_{ji}$.

Note that depending on the orientations and local configurations of i and j , each basic foam of interest comes in two flavors.

With these notations, if F is a spherical foam in good position, one has:

$$(16) \quad \chi(F_{ij}(c)) = A_{ij} + A_{ji} + U_{ij} + U_{ji} + \Lambda_{ij} + \Lambda_{ji} - Z_{ij} - Z_{ji} + V_{ij} + V_{ji} - Y_{ij} - Y_{ji}.$$

Lemma 2.17. *For any spherical foam F in good position, any coloring c and any two pigments i and j , the following identities hold:*

$$(17) \quad U_{ij} + A_{ji} = U_{ji} + A_{ij}.$$

Proof. Let us denote momentarily U and A for the number of caps and cups involving both i and j . Lemma 2.16, gives:

$$\begin{aligned} U + U_{ij} &= A + A_{ij} & \text{and} \\ U + U_{ji} &= A + A_{ji}. \end{aligned}$$

The identity of the lemma follows from the difference of these two identities. \square

Lemma 2.18. *For any (not-necessarily spherical) foam F in good position, any coloring c and any two pigments i and j , the following identities hold:*

$$(18) \quad Z_{ij} + V_{ij} = Y_{ij} + \Lambda_{ij},$$

$$(19) \quad Z_{ji} + V_{ji} = Y_{ji} + \Lambda_{ji}.$$

Proof. In the movie describing the surface $F_{ij}(c)$, we can track the split vertices at which pigments i and pigment j meet. Keeping track of orientations, they come in two flavors:



Since $F_{ij}(c)$ is a closed surface, at the beginning and at the end of the movie, there are no such vertices. Hence the number of births of these vertices is equal to the number of deaths of them. The identities (18) and (19) reflect that fact for each of the two flavors. \square

Recall that for s in \mathbb{k} , $\bar{s} = 1 - s$.

Corollary 2.19. *For any spherical foam F in good position, any coloring c , any two pigments i and j and any s in \mathbb{k} , the following identities hold:*

$$(20) \quad \begin{aligned} \frac{\chi(F_{ij}(c))}{2} &= \frac{1}{2} (A_{ij} + U_{ij} + A_{ji} + U_{ji}) \\ &\quad + s (\Lambda_{ij} + \Lambda_{ji} - Z_{ij} - Z_{ji}) + \bar{s} (V_{ij} + V_{ji} - Y_{ij} - Y_{ji}). \end{aligned}$$

Basic foam	Movie	$\chi(F_{ij}(c))$	Symbol
		+1	V_{ij}
		+1	V_{ji}
		+1	Λ_{ij}
		+1	Λ_{ji}
		-1	Z_{ij}
		-1	Z_{ji}
		-1	Y_{ij}
		-1	Y_{ji}
		+1	U_{ij}
		+1	U_{ji}
		+1	A_{ij}
		+1	A_{ji}

TABLE 1. In this table, the red dotted regions/lines represent facets with i in their colors in $F_{ij}(c)$; the blue hashed surface/zigzag lines represent facets with j in their colors.

2.5. \mathfrak{gl}_N -state spaces. In this section, we briefly recall the universal construction of TQFTs [BHMV95] in our context and construct \mathfrak{gl}_N -state spaces associated with webs as well as functors from foamy categories to algebraic categories. We follow [RW20a].

Let Γ be a web in \mathbb{R}^2 and denote by $\mathcal{V}_N(\Gamma)$ the free R_N -module generated by $\text{Hom}_{\text{Foam}}(\emptyset, \Gamma)$. It is graded by the degree of foams (3). Consider the R_N -bilinear form $\langle \cdot; \cdot \rangle_N$ on $\mathcal{V}_N(\Gamma)$ defined on foams by:

$$(21) \quad \langle F; G \rangle_N := \langle \overline{G} \circ F \rangle_N,$$

where \overline{G} is the foam $G: \Gamma \rightarrow \emptyset$ obtained by mirroring G along $\mathbb{R}^2 \times \{\frac{1}{2}\}$, so that $\overline{G} \circ F$ is a closed foam and $\langle \cdot; \cdot \rangle_N$ is well-defined.

For any web in \mathbb{R}^2 , define $\mathcal{F}_N(\Gamma)$ to be the quotient:

$$(22) \quad \mathcal{F}_N(\Gamma) := \mathcal{V}_N(\Gamma) / \text{Ker} \langle \cdot; \cdot \rangle_N.$$

As part of the universal construction, this extends for free to a functor $\mathcal{F}_N: \text{Foam} \rightarrow R_N\text{-Mod}_{\text{gr}}$.

Example 2.20 (Dot migration). Let $R \in \mathbb{Z}[x_1, \dots, x_a, y_1, \dots, y_b]^{S_{a+b}}$ be a polynomial in $a + b$ variables. Since

$$\mathbb{Z}[x_1, \dots, x_a, y_1, \dots, y_b]^{S_{a+b}} \subseteq \mathbb{Z}[x_1, \dots, x_a, y_1, \dots, y_b]^{S_a \times S_b},$$

the latter space being isomorphic to $\mathbb{Z}[x_1, \dots, x_a]^{S_a} \otimes_{\mathbb{Z}} \mathbb{Z}[y_1, \dots, y_b]^{S_b}$, one can write:

$$R = \sum_{j=1}^k R_j^{(1)} \otimes R_j^{(2)}$$

with $R_j^{(1)}$ in $\mathbb{Z}[x_1, \dots, x_a]^{S_a}$ and $R_j^{(2)}$ in $\mathbb{Z}[y_1, \dots, y_b]^{S_b}$ for all $1 \leq j \leq k$.

The following local relations³ hold for the colored evaluation:

$$(23) \quad \left\langle \left\langle \begin{array}{c} a+b \\ \bullet \\ R \end{array} \right\rangle, \mathcal{C} \right\rangle_N = \sum_{j=1}^k \left\langle \left\langle \begin{array}{c} a+b \\ \bullet \\ R_j^{(2)} \\ \bullet \\ R_j^{(1)} \end{array} \right\rangle, \mathcal{C} \right\rangle_N.$$

This follows from the very definition of the colored evaluation. Therefore, the same relation holds for the evaluation:

$$(24) \quad \left\langle \left\langle \begin{array}{c} a+b \\ \bullet \\ R \end{array} \right\rangle \right\rangle_N = \sum_{j=1}^k \left\langle \left\langle \begin{array}{c} a+b \\ \bullet \\ R_j^{(2)} \\ \bullet \\ R_j^{(1)} \end{array} \right\rangle \right\rangle_N.$$

³By *local relation*, we mean that given a collection of foams which make sense in the given context (here they should be closed) and are identical except in a ball where they are given by the model in the relation, then the relation holds for these foams.

This implies that for any web Γ , the following local⁴ relation holds in $\mathcal{F}_N(\Gamma)$:

$$(25) \quad \begin{array}{c} \text{Foam with } R \\ \bullet \\ R \end{array} = \sum_{j=1}^k \begin{array}{c} \text{Foam with } R_j^{(2)} \\ \bullet \\ R_j^{(1)} \end{array}.$$

Above, foams represent their equivalence classes in $\mathcal{F}_N(\Gamma)$. Many other local relations can be found in [RW20a, Section 3].

We can do the same construction restricting to spherical foams. In that case, the functor obtained is denoted \mathcal{F}_N^s . It is not obvious *a priori* how to compare these two functors. Indeed $\mathcal{V}_N^s(\Gamma)$ is contained in $\mathcal{V}_N(\Gamma)$, but it is then modded out by a smaller space than that for constructing $\mathcal{F}_N(\Gamma)$. It is not clear whether or not the functor \mathcal{F}_N^s is monoidal.

Proposition 2.21 ([RW20a, Proof of Theorem 3.30]). *The functor \mathcal{F}_N is monoidal and satisfies the following local relations (and their mirror images):*

$$(26) \quad \mathcal{F}_N(\emptyset) \cong R_N;$$

$$(27) \quad \mathcal{F}_N\left(a \circlearrowleft\right) \cong \begin{bmatrix} N \\ a \end{bmatrix} \mathcal{F}_N(\emptyset);$$

$$(28) \quad \mathcal{F}_N\left(\begin{array}{c} a \searrow \\ b \searrow \\ c \searrow \end{array} \begin{array}{c} a+b \\ \rightarrow \\ a+b+c \end{array}\right) \cong \mathcal{F}_N\left(\begin{array}{c} a \searrow \\ b \searrow \\ c \searrow \end{array} \begin{array}{c} a+b+c \\ \rightarrow \\ a+b+c \end{array}\right);$$

$$(29) \quad \mathcal{F}_N\left(\begin{array}{c} a \\ \rightarrow \\ a+b \end{array} \begin{array}{c} \curvearrowright \\ \rightarrow \\ a+b \end{array} \begin{array}{c} b \\ \rightarrow \\ a+b \end{array}\right) \cong \begin{bmatrix} a+b \\ a \end{bmatrix} \mathcal{F}_N\left(\begin{array}{c} a+b \\ \rightarrow \\ a+b \end{array}\right);$$

$$(30) \quad \mathcal{F}_N\left(\begin{array}{c} a \\ \rightarrow \\ a+b \end{array} \begin{array}{c} \curvearrowright \\ \rightarrow \\ a \end{array} \begin{array}{c} b \\ \rightarrow \\ a+b \end{array}\right) \cong \begin{bmatrix} N-a \\ b \end{bmatrix} \mathcal{F}_N\left(\begin{array}{c} a \\ \rightarrow \\ a \end{array}\right);$$

$$(31) \quad \mathcal{F}_N\left(\begin{array}{c} 1 \leftarrow \\ m+1 \leftarrow \\ m \leftarrow \end{array} \begin{array}{c} \rightarrow \\ \rightarrow \\ \rightarrow \end{array} \begin{array}{c} 1 \\ 1 \\ 1 \end{array}\right) \cong \mathcal{F}_N\left(\begin{array}{c} 1 \\ \rightarrow \\ m \end{array}\right) \\ \oplus [N-m-1] \mathcal{F}_N\left(\begin{array}{c} 1 \leftarrow \\ m \leftarrow \end{array} \begin{array}{c} \rightarrow \\ \rightarrow \end{array} \begin{array}{c} 1 \\ m \end{array}\right);$$

$$(32) \quad \mathcal{F}_N\left(\begin{array}{c} a \rightarrow \\ b+c \rightarrow \end{array} \begin{array}{c} \rightarrow \\ \rightarrow \end{array} \begin{array}{c} b \\ a+c \end{array}\right) \cong \bigoplus_{j=\max(0, b-a)}^b \begin{bmatrix} c \\ d-j \end{bmatrix} \mathcal{F}_N\left(\begin{array}{c} a \rightarrow \\ b+c \rightarrow \end{array} \begin{array}{c} \rightarrow \\ \rightarrow \end{array} \begin{array}{c} b \\ a+c \end{array}\right).$$

These isomorphisms (except the first one) are realized as images of (linear combinations of) foams under \mathcal{F}_N .

Wu [Wu14] proves that the relations given in Proposition 2.21 are enough to reduce any web to the empty web \emptyset . One clearly has $\mathcal{F}_N(\emptyset) \cong R_N$ which is a finitely generated projective R_N -module. Since being projective and finitely-generated is

⁴Following footnote 3, here to *make sense* means that foams have boundary equal to Γ .

preserved under finite direct sums and finite direct summands, the \mathfrak{gl}_N -state space of any web is a finitely generated projective R_N -module.

Corollary 2.22 ([RW20a, Corollary 3.31]). *The functor \mathcal{F}_N takes value in $R_N\text{-proj}_{\text{gr}}$, the category of finitely generated, graded, projective (and therefore free) R_N -modules.*

Proposition 2.23. *Relations (26), (27), (28), (29), (30) and (32) are satisfied by \mathcal{F}_N^s .*

Sketch of proof. The foams used in [RW20a] to define these isomorphisms are spherical. Therefore the proof applies *mutatis mutandis* to \mathcal{F}_N^s . \square

There is a special class of webs and foams for which \mathcal{F}_N and \mathcal{F}_N^s agree. Recall that vinyl graphs are directed webs in \mathcal{A} . Note that any vinyl graph Γ has a well-defined index k : that is the sum of thicknesses of edges intersected by a generic ray, see Figure 4. Collections of concentric positively oriented circles of various thicknesses provide examples of vinyl graphs. They are denoted $\mathbb{S}_{\underline{k}}$ where \underline{k} is the list of thicknesses, read from the center of the annulus going outwards, (see Figure 4).

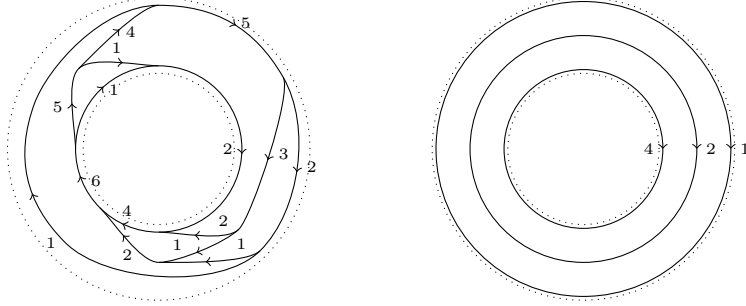

FIGURE 4. Two vinyl graphs of index 7, the one on the right-hand side is $\mathbb{S}_{(4,2,1)}$.

Definition 2.24. Let Γ_0 and Γ_1 be two vinyl graph. A *vinyl foam* $F: \Gamma_0 \rightarrow \Gamma_1$ is a foam in $\mathcal{A} \times [0, 1]$ such that the projection onto $\mathbb{S}^1 \times [0, 1]$ has no critical points. As usual, these foams are regarded up to ambient isotopy. Note that in such a situation, Γ_0 and Γ_1 have necessarily the same index k . We then say that F has *index k* .

A vinyl foam can be decomposed into basic foams without any cups, caps or saddles. Note that for a foam, being vinyl is even more restrictive than being spherical.

Vinyl graphs and vinyl foams of a given index k fit into a category that we denote by vFoam_k . Taking the disjoint unions of these categories for $k \in \mathbb{N}$, we can form a category vFoam which is endowed with a monoidal structure given by taking concentric disjoint union. Note however that this category is not symmetric.

Proposition 2.25. *When restricted to the category vFoam , the functors \mathcal{F}_N and \mathcal{F}_N^s are isomorphic.*

Sketch of proof. This is a direct consequence of the Queffelec–Rose–Sartori algorithm [QRS18] which rephrases Wu’s results in the vinyl setting. It says that one can reduce any vinyl graph to a collection of circles using relations (28), (29) and (32). Once dealing with circles one can use relation (27). All these relations are valid for \mathcal{F}_N and \mathcal{F}_N^s which concludes the argument. For a more detailed proof of a similar argument, we refer to [BPRW21, Propositions 2.25 and 4.11]. \square

The restriction to vinyl graphs and vinyl foams is common and relates to the presentations of links as braid closures. For instance, triply-graded homology [Rou17, Kho07], symmetric \mathfrak{gl}_N -homologies [Cau17, QRS18, RW20b] and \mathfrak{gl}_0 -homology [RW19] are defined using this framework. On the one hand, this is topologically quite restrictive since in this context, link cobordisms are not very interesting. On the other hand the relation with Soergel bimodules and the power of representation theory are very insightful there. Soergel bimodules can be understood via foams (see [Wed19, Proposition 3.4], [RW20b, Proposition 4.15], [BPRW21, Proposition 2.29]), so that part of what we say here can be applied to that context. See Section 4.5 for an actual comparison.

2.6. Base change. The discussion in this subsection is classical and holds for both \mathcal{F}_N and \mathcal{F}_N^s . For brevity, we only discuss \mathcal{F}_N .

The construction of Section 2.5 can be deformed using a unitary ring morphism $\phi: R_N \rightarrow S$. One can construct a functor \mathcal{F}_N^ϕ from the category \mathbf{Foam} to $S\text{-mod}$ by considering $\mathcal{V}_N^\phi(\Gamma)$ to be the free S -module generated by foams from the empty foam to Γ and modding out this space by the S bilinear induced by $\phi \circ \langle \cdot; \cdot \rangle_N$. If S is non-negatively graded and ϕ respects gradings, then \mathcal{F}_N^ϕ takes values in $S\text{-mod}_{\text{gr}}$. We say that the functor \mathcal{F}_N^ϕ is obtained from \mathcal{F}_N by *base change*.

The isomorphisms stated in Proposition 2.21 still hold since their proofs are based on identities of evaluations of closed foams and these identities are preserved under ring morphisms ϕ .

Two special base changes will be of interest to us. Suppose \mathbb{k} is a unital ring and consider it as graded and concentrated in degree 0. Consider $\varphi: \mathbb{Z} \rightarrow \mathbb{k}$ the unique unitary ring morphism. This induces a ring morphism φ_e from R_N to $\mathbb{k}_N = \mathbb{k}[X_1, \dots, X_N]^{S_N} = \mathbb{k}[E_1, \dots, E_N]$ by mapping E_i to E_i for all $1 \leq i \leq N$. The functor induced by this base change is denoted ${}^E\mathcal{F}_N^{\mathbb{k}}$ where the letter ‘E’ stands for *equivariant*.

The same morphism φ induces a morphism φ_0 from R_N to \mathbb{k} by mapping E_i to 0 for all $1 \leq i \leq N$. As before, this morphism preserves respects the grading. This base change is denoted by ${}^0\mathcal{F}_N^{\mathbb{k}}$.

Remark 2.26. We would like to make a couple of comments about notation.

- (1) The superscripts of the functors and modules discussed in this notation contains information about ring morphisms ϕ and also whether or not spherical versions of foams are being used. Sometimes only one these superscripts appears and we hope that the reader will understand what it is referring to from context.
- (2) On several occasions, the superscript referring to the ring morphism is replaced by the target of the morphism.

3. ALGEBRAIC PRELIMINARIES

3.1. Symmetries of foam evaluations. We start by investigating automorphisms of foam evaluations. For now, let us temporarily forget the gradings involved. By an *automorphism* of \mathfrak{gl}_N -foams, we mean an invertible operation that respects the monoidal categorical structure of \mathbf{Foam} , that is, such an operation respects forming disjoint unions (monoidal structure) and gluing of foams along boundaries. Since foams are only considered up to ambient isotopies, such automorphisms will also be considered in their isotopy classes.

As an example, the involution of turning an arbitrary foam upside down is an automorphism of \mathfrak{gl}_N -foams. Similarly, fix $a \in \mathbb{k}$, and changing any polynomial $R(X_1, \dots, X_k)$ occurring as foam decoration into $R(X_1 - a, \dots, X_k - a)$ is an (ungraded) automorphism.

Let G be a subgroup of automorphisms of \mathbf{Foam} . Suppose that G also acts as \mathbb{Z} -linear automorphisms on the ground ring R_N . We say that G is *compatible* with foam evaluations if, for any $g \in G$, we have

$$(33a) \quad \langle g \cdot F \rangle_N = g \cdot \langle F \rangle_N.$$

Clearly, such compatible automorphisms preserve the kernel of (22), and descend to automorphisms of state spaces of webs.

In particular, if F_1, F_2 are disjoint foams, preserving the monoidal structure leads to

$$(33b) \quad \langle g \cdot (F_1 \sqcup F_2) \rangle_N = (g \cdot \langle F_1 \rangle_N)(g \cdot \langle F_2 \rangle_N).$$

Furthermore, if F and G are foams that share a common boundary web Γ , we have

$$(33c) \quad \langle (g \cdot F); (g \cdot G) \rangle_N = g \cdot \langle F; G \rangle_N.$$

Infinitesimally, if $g = e^{t\ell}$ is a one-parameter family of compatible automorphisms, where t is a formal parameter, then taking derivatives of equations (33a), (33b), (33c) and evaluating at $t = 0$ results in the condition of a Lie algebra element acting on foam evaluations. For instance, fix $a \in \mathbb{k}$, and consider the action by changing any polynomial decoration $R(X_1, \dots, X_k)$ occurring on foams into $R(X_1 - a, \dots, X_k - a)$. Linearizing this action gives us the differential action by the vector field $\sum \partial/\partial X_i$.

If ℓ is an *infinitesimal symmetry* of foam evaluations, then it must satisfy

$$(34a) \quad \langle \ell \cdot F \rangle_N = \ell \cdot \langle F \rangle_N.$$

Furthermore, with respect to the monoidal structures, there are Leibniz rules that are linearized from (33b) and (33c):

$$(34b) \quad \langle \ell \cdot (F_1 \sqcup F_2) \rangle_N = (\ell \cdot \langle F_1 \rangle_N) \langle F_2 \rangle_N + \langle F_1 \rangle_N (\ell \cdot \langle F_2 \rangle_N).$$

$$(34c) \quad \ell \cdot \langle F; G \rangle_N = \langle \ell \cdot F; G \rangle_N + \langle F; \ell \cdot G \rangle_N.$$

We will axiomatize the Lie algebra action in what follows.

3.2. Smash products. In what follows, L is a Lie algebra and A is an associative algebra both over a common commutative ring \mathbb{k} . Unadorned scalar products are over \mathbb{k} . The category of L -modules is naturally endowed with a monoidal structure: for any L -modules M and N , any $m \in M$, $n \in N$ and $\ell \in L$, define:

$$(35) \quad \ell \cdot (m \otimes n) := (\ell \cdot m) \otimes n + m \otimes (\ell \cdot n),$$

and declare that L acts by 0 on \mathbb{k} (which is the monoidal unit). This is equivalent to the statement that the universal enveloping algebra $U(L)$ is endowed with a Hopf algebra structure by defining for all ℓ in L :

$$(36) \quad \Delta(\ell) = 1 \otimes \ell + \ell \otimes 1 \quad \epsilon(\ell) = 0.$$

The algebra $A = (A, \mu, \eta)$ is an L -module algebra if A is an L -module and the maps $\mu: A \otimes A \rightarrow A$ and $\eta: \mathbb{k} \rightarrow A$ are morphisms of L -modules. In other words, A is an algebra object in $L\text{-mod}$.

When A is an L -module algebra, any element $\ell \in L$ defines an operator $\widehat{\ell}$ on A , which because of (36) satisfies the Leibniz rule, that is, for any $a_1, a_2 \in A$, one has:

$$(37) \quad \widehat{\ell}(a_1 a_2) = \widehat{\ell}(a_1) a_2 + a_1 \widehat{\ell}(a_2).$$

Example 3.1. For any associative algebra A , the Lie algebra $\text{Der}(A)$ acts on A naturally and A is a $\text{Der}(A)$ -module algebra. Actually any L -module algebra structure on A arises from a Lie algebra morphism $\varphi: L \rightarrow \text{Der}(A)$.

Fix A , an L -module algebra. Define the associative algebra $A\#U(L)$ as follows. As a \mathbb{k} -module, $A\#U(L)$ is equal to $A \otimes U(L)$. The multiplication on $A\#U(L)$ is defined by:

$$(38) \quad (a_1 \otimes \ell_1) \cdot (a_2 \otimes \ell_2) := (a_1 \ell_1 \cdot a_2 \otimes \ell_2) + (a_1 a_2 \otimes \ell_1 \ell_2).$$

The algebra $A\#U(L)$ is called the *smash product algebra of A and L* . Note that both A and $U(L)$ lie in $A\#U(L)$ as subalgebras (as $A \otimes 1_{U(L)}$ and $1_A \otimes U(L)$ respectively).

An $A\#U(L)$ -module is called an *L -equivariant A -module*. An L -equivariant A -module M is an A -module with an L -action compatible with the action of A (remember that L acts on A by derivations) in the following sense. For any $a \in A, \ell \in L$ and $m \in M$:

$$(39) \quad \ell \cdot (a \cdot m) = (\ell \cdot a) \cdot m + a \cdot (\ell \cdot m).$$

If H is a Hopf algebra over \mathbb{k} acting on A , we adopt the same terminology and let $A\#H$ be the associative algebra which as a \mathbb{k} -module is equal to $A \otimes H$ and whose multiplication is given by formula (38), (replacing ℓ_1, ℓ_2 by $h_1, h_2 \in H$). For a more systematic account on smash products, we refer the reader to [Swe69, Chapter IV].

3.3. p -DG structure. Here we recall some definitions from [QRSW21, Section 2.1]. Let $H' = \mathbb{Z}[\partial]$ be the graded polynomial algebra generated by a degree 2 generator ∂ . Define on H' a *comultiplication* $\Delta : H' \rightarrow H' \otimes H'$ by setting

$$(40a) \quad \Delta(\partial) = \partial \otimes 1 + 1 \otimes \partial.$$

Also set the *counit* $\epsilon : H' \rightarrow \mathbb{k}$ to be

$$(40b) \quad \epsilon(\partial) = 0,$$

and *antipode* $S : H' \rightarrow H'$ to be

$$(40c) \quad S(\partial) = -\partial.$$

Then H' is a graded Hopf algebra.

The ideal $(\partial^p, p) \subset H'$ is a Hopf ideal, in the sense that, on the top of being an ideal, it is closed under Δ, ϵ and S . The graded quotient $H'/(\partial^p, p)$ inherits a graded Hopf algebra structure over \mathbb{F}_p and is denoted by H . The structure maps of H are still denoted Δ, ϵ and S .

The element $\partial \in H'$ acts on algebras as derivations, in other words, any derivation on an algebra A induces an H' -module structure on A . More generally, if M is an A -module with A endowed with a derivation, any derivation on M gives rise to an H' -action on M .

Lemma 3.2. *Mapping ∂ to $\sum_{k=1}^a x_k^2 \frac{\partial}{\partial x_k}$ induces an action of the Hopf algebra H on $\mathbb{F}_p[x_1, \dots, x_a]$.*

Proof. The only slightly non-trivial thing to show is that $\partial^p = 0$. Using the Leibniz rule, it is enough to show that $\partial^p x_k = 0$ for all $1 \leq k \leq a$. This follows from the formula:

$$\partial^j x_k = j! x_k^{j+1}$$

which is easily proved by induction, and the fact that we are working over a field of characteristic p . \square

For this section, we let A be the p -DG algebra $\mathbb{F}_p[x_1, \dots, x_a]$. If $a_1 + a_2 + \dots + a_\ell = a$ is a decomposition of a into positive integers, $G := S_{a_1} \times S_{a_2} \times \dots \times S_{a_\ell}$ acts naturally on A by permuting variables. Since the definition of ∂ is symmetric in the variables, one has the following corollary.

Corollary 3.3. *The H -action on A induces an H -action on A^G .*

Let t be a homogeneous polynomial in x_1, \dots, x_a of degree⁵ 2. Then define A^t to be equal to A as an A -module, but endowed with an H' -action defined for any $P \in A^t$ by:

$$(41) \quad \partial_{A^t}(P) = \partial_A(P) + tP.$$

We say that the H' -module structure is *twisted* by t . Note that $t = \partial_{A^t}(1)$.

Lemma 3.4. *For any homogeneous polynomial t of degree 2, $\partial_{A^t}^p = 0$.*

Proof. One has for all $P \in A$,

$$(42) \quad \partial_{A^t}^k(P) = \sum_{j=0}^k \binom{k}{j} \partial_A^j(P) \partial_{A^t}^{k-j}(1).$$

We already know that $\partial_A^p(P) = 0$, so it is enough to show that $\partial_{A^t}^p(1) = 0$ since $\binom{p}{j} = 0$ for $j = 1, \dots, p-1$. Moreover, if t_1 and t_2 are two homogeneous polynomials of degree 2, one has:

$$(43) \quad \partial_{A^{t_1+t_2}}^k(1) = \sum_{j=0}^k \binom{k}{j} \partial_{A^{t_1}}^j(1) \partial_{A^{t_2}}^{k-j}(1),$$

so that it is enough to prove the statement in the case $t = \mu_i x_i$ for $1 \leq i \leq a$. In this case, an easy induction shows:

$$(44) \quad \partial_{A^t}^k(1) = \left(\prod_{j=0}^{k-1} (\mu_i + j) \right) x_i^k.$$

The proof is now complete since the quantity $\prod_{j=0}^{p-1} (\mu + j)$ is 0 in \mathbb{F}_p for any $\mu \in \mathbb{F}_p$. \square

Remark 3.5. If t is invariant under the action of $G := S_{a_1} \times S_{a_2} \times \dots \times S_{a_\ell}$, the above-mentioned action preserves A^G and one has a well-defined H -action on $(A^t)^G$.

3.4. One-half of the Witt algebra. In what follows we will define actions of the Lie algebras \mathfrak{sl}_2 and of a part of the Witt algebra \mathfrak{W}_{-1}^∞ . We briefly recall how these Lie algebras are defined.

The Lie algebra \mathfrak{sl}_2 over \mathbb{k} is generated by symbols e, f and h subject to the relations:

$$(45) \quad [e, f] = h, \quad [h, e] = 2e, \quad [h, f] = -2f.$$

As a \mathbb{k} -module, it is free of rank 3 and can be graded by declaring that $\deg(e) = -2$, $\deg(h) = 0$ and $\deg(f) = 2$ (or by a scaling of that grading).

The Lie algebra \mathfrak{W} is generated by symbols $(L_n)_{n \in \mathbb{Z}}$ subject to the relations⁶

$$(46) \quad [L_n, L_m] = (n - m)L_{m+n}$$

for all $n, m \in \mathbb{Z}$.

As a \mathbb{k} -module, it is free of countable rank and can be graded by declaring that $\deg(L_n) = 2n$ for all $n \in \mathbb{Z}$ (or by scaling of that).

We will be interested in the Lie subalgebra \mathfrak{W}_{-1}^∞ generated by symbols $(L_n)_{n \in \mathbb{N}_{-1}}$, where $\mathbb{N}_{-1} = \{n \in \mathbb{Z} | n \geq -1\}$.

⁵Remember that variables have degree 2, so that t is a linear polynomial.

⁶In [KR16], the presentation is different: $L_n^{[KR16]} \leftrightarrow -L_n$.

Lemma 3.6. *The map:*

$$\iota: \begin{cases} \mathbf{e} & \mapsto \mathbf{L}_{-1} \\ \mathbf{h} & \mapsto 2\mathbf{L}_0 \\ \mathbf{f} & \mapsto -\mathbf{L}_1 \end{cases}$$

induces a morphism of Lie algebras from \mathfrak{sl}_2 to \mathfrak{W} whose image is in \mathfrak{W}_{-1}^∞ . If 2 is not a zero divisor in \mathbb{k} , the map is injective.

Proof. It is straightforward to check that the relations given in (45) are satisfied by $\iota(\mathbf{e})$, $\iota(\mathbf{h})$ and $\iota(\mathbf{f})$:

$$\begin{aligned} [\iota(\mathbf{e}), \iota(\mathbf{f})] &= [\mathbf{L}_{-1}, -\mathbf{L}_1] = [\mathbf{L}_1, \mathbf{L}_{-1}] = 2\mathbf{L}_0 = \iota(\mathbf{h}) \\ [\iota(\mathbf{h}), \iota(\mathbf{e})] &= [2\mathbf{L}_0, \mathbf{L}_{-1}] = 2[\mathbf{L}_0, \mathbf{L}_{-1}] = 2\mathbf{L}_{-1} = 2\iota(\mathbf{e}), \\ [\iota(\mathbf{h}), \iota(\mathbf{f})] &= [2\mathbf{L}_0, -\mathbf{L}_1] = -2[\mathbf{L}_0, \mathbf{L}_1] = 2\mathbf{L}_1 = -2\iota(\mathbf{f}). \end{aligned} \quad \square$$

Remark 3.7. Another possible embedding of \mathfrak{sl}_2 in \mathfrak{W}_{-1}^∞ is given by:

$$\iota': \begin{cases} \mathbf{e} & \mapsto -\mathbf{L}_1 \\ \mathbf{h} & \mapsto -2\mathbf{L}_0 \\ \mathbf{f} & \mapsto \mathbf{L}_{-1} \end{cases}.$$

The morphism ι and ι' are related by the \mathfrak{sl}_2 -automorphism

$$\begin{cases} \mathbf{e} & \mapsto \mathbf{f} \\ \mathbf{h} & \mapsto -\mathbf{h} \\ \mathbf{f} & \mapsto \mathbf{e} \end{cases}.$$

The Lie algebra \mathfrak{W}_{-1}^∞ acts on the polynomial ring $\mathbb{k}[z]$ by setting $\mathbf{L}_n \cdot Q(z) = -z^{n+1}Q'(z)$. For any positive integer k , this action generalizes to $\mathbb{k}[z_1, \dots, z_k]$ as follows. For any $Q \in \mathbb{k}[z_1, \dots, z_k]$, set

$$(47) \quad \mathbf{L}_n \cdot Q = -\sum_{i=1}^k z_i^{n+1} \frac{\partial Q}{\partial z_i}.$$

Note that $A_k = \mathbb{k}[z_1, \dots, z_k]^{S_k}$ is a sub- \mathfrak{W}_{-1}^∞ -module for this action. One can naturally extend this action on $\mathbb{k}(z_1, \dots, z_k)$ by imposing the Leibniz rule:

$$\mathbf{L}_n \cdot \frac{Q_1}{Q_2} = \frac{(\mathbf{L}_n \cdot Q_1)Q_2 - Q_1(\mathbf{L}_n \cdot Q_2)}{Q_2^2}.$$

Example 3.8. If x and y are two variables, then for all $n \geq 0$,

$$(48) \quad \mathbf{L}_n \cdot (x - y) = -(x^{n+1} - y^{n+1}) = -(x - y) \left(\sum_{i+j=0}^n x^i y^j \right)$$

$$(49) \quad = -(x - y) \left(\sum_{i+j=0}^n p_i(x) p_j(y) \right) = -(x - y) h_n(x, y)$$

where $p_i(x)$ and $p_j(y)$ denote the i th and the j th power sum symmetric polynomials in variables x and y respectively (that is to say x^i and y^j), and h_n is the n th complete homogeneous symmetric polynomial.

Let $\underline{x} := \{x_1, \dots, x_a\}$ be a indeterminates and $\underline{y} := \{y_1, \dots, y_b\}$ be b other indeterminates. Set $\nabla(\underline{x}, \underline{y}) = \prod_{i=1}^a \prod_{j=1}^b (x_i - y_j)$. One has

$$(50) \quad \begin{aligned} \mathbf{L}_n \cdot \nabla(\underline{x}, \underline{y}) &= -\sum_{i=1}^a \sum_{j=1}^b \sum_{k+\ell=n} p_k(x_i) p_\ell(y_j) \nabla(\underline{x}, \underline{y}) \\ &= -\sum_{k+\ell=n} p_k(\underline{x}) p_\ell(\underline{y}) \nabla(\underline{x}, \underline{y}); \end{aligned}$$

and

$$(51) \quad \mathbf{L}_n \cdot \nabla(\underline{x}, \underline{y})^\alpha = -\alpha \sum_{k+\ell=n} p_k(\underline{x}) p_\ell(\underline{y}) \nabla(\underline{x}, \underline{y})^\alpha.$$

3.5. Twists. As we have seen in the previous subsection, \mathfrak{W}_{-1}^∞ acts naturally on polynomial rings. We will see that this action can be twisted.

Definition 3.9 ([KR16]). Let A be an \mathfrak{W}_{-1}^∞ -module algebra. A family of elements $\tau := (\tau_n)_{n \in \mathbb{N}_{-1}} \in A^{\mathbb{N}_{-1}}$ is \mathfrak{W}_{-1}^∞ -flat if for all m and n in \mathbb{N}_{-1} ,

$$(52) \quad \mathbf{L}_n \cdot \tau_m - \mathbf{L}_m \cdot \tau_n = (n - m)\tau_{m+n}.$$

Remark 3.10. In general the defect of \mathfrak{W}_{-1}^∞ -flatness of a sequence τ , encoded by

$$(53) \quad \mathbf{L}_n \cdot \tau_m - \mathbf{L}_m \cdot \tau_n - (n - m)\tau_{m+n}$$

is called the \mathfrak{W}_{-1}^∞ -curvature of τ and is denoted $\kappa(\tau)$.

Example 3.11. (1) For any $i \in \{1, \dots, k\}$, the family $((n+1)x_i^n)_{n \in \mathbb{N}_{-1}} \in \mathbb{k}[x_1, \dots, x_k]^{\mathbb{N}_{-1}}$ is \mathfrak{W}_{-1}^∞ -flat.
(2) For any $i \neq j \in \{1, \dots, k\}$, the family $(h_n(x_i, x_j))_{n \in \mathbb{N}_{-1}} \in \mathbb{k}[x_1, \dots, x_k]^{\mathbb{N}_{-1}}$ is \mathfrak{W}_{-1}^∞ -flat.

The set of \mathfrak{W}_{-1}^∞ -flat sequences of an \mathfrak{W}_{-1}^∞ -module A is a \mathbb{k} -submodule of $A^{\mathbb{N}_{-1}}$ since for arbitrary sequences τ and τ' in $A^{\mathbb{N}_{-1}}$, one has $\kappa(\tau + \tau') = \kappa(\tau) + \kappa(\tau')$.

Let A be a commutative \mathfrak{W}_{-1}^∞ -module algebra and τ be an \mathfrak{W}_{-1}^∞ -flat sequence. For any $n \in \mathbb{N}_{-1}$, define the operator $\mathbf{L}_n^{(\tau)}$ on A by:

$$(54) \quad \mathbf{L}_n^{(\tau)}(a) = \mathbf{L}_n \cdot a + \tau_n a.$$

for all $a \in A$.

Lemma 3.12. Mapping \mathbf{L}_n to $\mathbf{L}_n^{(\tau)}$ endows A with a (new) \mathfrak{W}_{-1}^∞ -module structure.

We write A^τ to encode this new \mathfrak{W}_{-1}^∞ -module structure, and we say that A is twisted by τ . Note that in general A^τ is not anymore a \mathfrak{W}_{-1}^∞ -module algebra, but rather an \mathfrak{W}_{-1}^∞ -equivariant A -module (isomorphic to A as an A -module).

Proof. This is a straightforward computation. For any $m, n \in \mathbb{N}_{-1}$, one has:

$$(55) \quad \begin{aligned} \mathbf{L}_n^{(\tau)}(\mathbf{L}_m^{(\tau)}(a)) &= \mathbf{L}_n^{(\tau)}(\mathbf{L}_m \cdot a + \tau_m a) \\ &= \mathbf{L}_n \cdot (\mathbf{L}_m \cdot a) + \mathbf{L}_n \cdot (\tau_m a) + \tau_n (\mathbf{L}_m \cdot a + \tau_m a) \\ &= \mathbf{L}_n \cdot (\mathbf{L}_m \cdot a) + (\mathbf{L}_n \cdot \tau_m) a + \tau_m \mathbf{L}_n \cdot a + \tau_n \mathbf{L}_m \cdot a + \tau_n \tau_m a. \end{aligned}$$

Thus

$$(56) \quad \begin{aligned} [\mathbf{L}_n^{(\tau)}, \mathbf{L}_m^{(\tau)}](a) &= [\mathbf{L}_n, \mathbf{L}_m] \cdot a + (\mathbf{L}_n(\tau_m) - \mathbf{L}_m(\tau_n))a \\ &= (n - m)\mathbf{L}_{n+m}(a) + (n - m)\tau_{m+n}a \\ &= (n - m)\mathbf{L}_{n+m}^{(\tau)}(a). \end{aligned} \quad \square$$

Suppose furthermore that M is an \mathfrak{W}_{-1}^∞ -equivariant A -module, then the \mathfrak{W}_{-1}^∞ -module $A^\tau \otimes_A M$ is denoted M^τ . If τ and τ' are two \mathfrak{W}_{-1}^∞ -flat sequences, then

$$(57) \quad (M^{\tau'})^\tau = A^\tau \otimes_A M^{\tau'} = A^\tau \otimes_A (A^{\tau'} \otimes_A M) \cong A^{\tau+\tau'} \otimes M = M^{\tau+\tau'}.$$

4. ACTION ON FOAMS

4.1. Action of one-half of the Witt algebra. For simplicity we will suppose that 2 is invertible in \mathbb{k} . However, this hypothesis is not always necessary. See Remark 4.8.

Consider a set of indeterminates $\underline{x} = \{x_1, \dots, x_a\}$.

Definition 4.1. A *Witt-sequence* $(\lambda_n)_{n \in \mathbb{N}_{-1}} \in \mathbb{k}^{\mathbb{N}_{-1}}$ is a sequence such that $\lambda_{-1} = 0$ and for any $m, n \in \mathbb{N}$,

$$(58) \quad n\lambda_n - m\lambda_m = (n - m)\lambda_{m+n}.$$

For any $\lambda \in \mathbb{k}$, the sequence given by $\lambda_n = \lambda(n + 1)$ is a Witt sequence. Fix an element $s \in \mathbb{k}$, and three Witt-sequences $(\lambda_n)_{n \in \mathbb{N}_{-1}}$, $(\mu_n)_{n \in \mathbb{N}_{-1}}$ and $(\nu_n)_{n \in \mathbb{N}_{-1}}$.

Recall that for any i in \mathbb{N} , the power sum polynomial $p_i(\underline{x})$ is defined as:

$$(59) \quad p_i(\underline{x}) = x_1^i + \dots + x_a^i.$$

Decorations of foams that we will consider will often be power sums, so we use the following notation:

$$(60) \quad \boxed{\spadesuit_i} = \boxed{p_i}.$$

Note that in particular, on a facet of thickness a , $\spadesuit_0 = a$. Following Section 2.3, let $\widehat{\spadesuit}_i$ denote the i th power sum in the variables which are not in the facet. In other words,

$$(61) \quad \boxed{\widehat{\spadesuit}_i} = P_i \cdot \boxed{} - \boxed{\spadesuit_i}.$$

We now define a sequence of operators $(\mathbf{L}_n)_{n \in \mathbb{N}_{-1}}$ acting on basic foams. For $n \in \mathbb{N}_{-1}$ set:

$$(62) \quad \mathbf{L}_n \left(\boxed{R} \right) = \boxed{\mathbf{L}_n(R)}$$

$$(63) \quad \mathbf{L}_n \left(\begin{array}{c} \text{Foam with } a, b, c \text{ facets} \\ \text{and } a+b+c \text{ boundary} \end{array} \right) = \mathbf{L}_n \left(\begin{array}{c} \text{Foam with } a, b, c \text{ facets} \\ \text{and } a+b+c \text{ boundary} \end{array} \right) = 0$$

$$(64) \quad \mathbf{L}_n \left(\begin{array}{c} \text{Foam with } a, b \text{ facets} \\ \text{and } a+b \text{ boundary} \end{array} \right) = \lambda_n \cdot \begin{array}{c} \text{Foam with } \spadesuit_n \text{ on } a \text{ facet} \\ \text{and } \spadesuit_0 \text{ on } b \text{ facet} \end{array} + \mu_n \cdot \begin{array}{c} \text{Foam with } \spadesuit_0 \text{ on } a \text{ facet} \\ \text{and } \spadesuit_n \text{ on } b \text{ facet} \end{array} \\ + s \sum_{k+\ell=n} \begin{array}{c} \text{Foam with } \spadesuit_k \text{ on } a \text{ facet} \\ \text{and } \spadesuit_\ell \text{ on } b \text{ facet} \end{array}$$

$$(65) \quad \mathbf{L}_n \left(\begin{array}{c} \text{Diagram 1} \\ \text{Diagram 2} \end{array} \right) = -\lambda_n \cdot \begin{array}{c} \text{Diagram 3} \\ \text{Diagram 4} \end{array} - \mu_n \cdot \begin{array}{c} \text{Diagram 5} \\ \text{Diagram 6} \end{array} + \bar{s} \sum_{k+\ell=n} \begin{array}{c} \text{Diagram 7} \\ \text{Diagram 8} \end{array}$$

$$(66) \quad \mathbf{L}_n \left(\begin{array}{c} \text{Diagram 9} \\ \text{Diagram 10} \end{array} \right) = \lambda_n \cdot \begin{array}{c} \text{Diagram 11} \\ \text{Diagram 12} \end{array} + \mu_n \cdot \begin{array}{c} \text{Diagram 13} \\ \text{Diagram 14} \end{array} - \bar{s} \sum_{k+\ell=n} \begin{array}{c} \text{Diagram 15} \\ \text{Diagram 16} \end{array}$$

$$(67) \quad \mathbf{L}_n \left(\begin{array}{c} \text{Diagram 17} \\ \text{Diagram 18} \end{array} \right) = -\lambda_n \cdot \begin{array}{c} \text{Diagram 19} \\ \text{Diagram 20} \end{array} - \mu_n \cdot \begin{array}{c} \text{Diagram 21} \\ \text{Diagram 22} \end{array} - s \sum_{k+\ell=n} \begin{array}{c} \text{Diagram 23} \\ \text{Diagram 24} \end{array}$$

$$(68) \quad \mathbf{L}_n \left(\begin{array}{c} \text{Diagram 25} \\ \text{Diagram 26} \end{array} \right) = \nu_n \cdot \begin{array}{c} \text{Diagram 27} \\ \text{Diagram 28} \end{array} - \nu_n \cdot \begin{array}{c} \text{Diagram 29} \\ \text{Diagram 30} \end{array} + \frac{1}{2} \sum_{k+\ell=n} \begin{array}{c} \text{Diagram 31} \\ \text{Diagram 32} \end{array}$$

$$(69) \quad \mathbf{L}_n \left(\begin{array}{c} \text{Diagram 33} \\ \text{Diagram 34} \end{array} \right) = -\nu_n \cdot \begin{array}{c} \text{Diagram 35} \\ \text{Diagram 36} \end{array} + \nu_n \cdot \begin{array}{c} \text{Diagram 37} \\ \text{Diagram 38} \end{array} + \frac{1}{2} \sum_{k+\ell=n} \begin{array}{c} \text{Diagram 39} \\ \text{Diagram 40} \end{array}$$

Finally extend the action of \mathbf{L}_n on all foams in good position by imposing the Leibniz rule.

The reader may wonder why in these definitions of the operators \mathbf{L}_n , some of the same parameters are used for different foams. The reason is that we eventually want these definitions to be consistent and in particular that they are not sensitive to ambient isotopies. For instance we would like that

$$\mathbf{L}_n \left(\begin{array}{c} \text{Diagram 41} \\ \text{Diagram 42} \end{array} \right) = 0.$$

The parameters are chosen so that such relations hold. Note however that we do not have a full list of moves to be checked to ensure consistency of these definitions. Instead we will use the power of the universal construction (see Proposition 4.3 and the proof of Theorem 4.4).

Lemma 4.2. *Mapping \mathbf{L}_n to \mathbf{L}_n for all $n \in \mathbb{N}_{-1}$ defines an action of \mathfrak{W}_{-1}^∞ on the \mathbb{k} -module generated by spherical foams in good position.*

Proof. We need to prove that $\mathbf{L}_n \circ \mathbf{L}_m - \mathbf{L}_m \circ \mathbf{L}_n = (n - m)\mathbf{L}_{n+m}$ for any two n, m in \mathbb{N}_{-1} . Without loss of generality, we may fix m and n in \mathbb{N}_{-1} with $m \geq n$. Note that for any two spherical foams F and G in good position,

$$(70) \quad [\mathbf{L}_n, \mathbf{L}_m](F \circ G) = (\mathbf{L}_n \circ \mathbf{L}_m)(F \circ G) - (\mathbf{L}_m \circ \mathbf{L}_n)(F \circ G)$$

$$(71) \quad = \mathbf{L}_n(\mathbf{L}_m(F) \circ G + F \circ \mathbf{L}_m(G)) - \mathbf{L}_m(\mathbf{L}_n(F) \circ G + F \circ \mathbf{L}_n(G))$$

$$(72) \quad = (\mathbf{L}_n(\mathbf{L}_m(F)) - \mathbf{L}_m(\mathbf{L}_n(F))) \circ G + F \circ (\mathbf{L}_n(\mathbf{L}_m(G)) - \mathbf{L}_m(\mathbf{L}_n(G)))$$

$$(73) \quad = ([\mathbf{L}_n, \mathbf{L}_m](F)) \circ G + F \circ ([\mathbf{L}_n, \mathbf{L}_m](G)).$$

Thus $\mathbf{L}_n \circ \mathbf{L}_m - \mathbf{L}_m \circ \mathbf{L}_n$ satisfies the Leibniz rule as well as $(n - m)\mathbf{L}_{n+m}$.

Therefore, it is enough to check that the relations hold on basic webs. For traces of isotopies, this is trivial. For polynomials this follows from the fact that \mathfrak{W}_{-1}^∞ acts on the ring of symmetric polynomials defined in (47). The remaining basic foams to inspect are the zip, unzip, digon-cup, digon-cap, cap and cup foams. In all cases, this is a relatively straightforward computation (and all computations are similar). We treat the cup foam and leave the rest to the reader.

$$(74) \quad \begin{aligned} \mathbf{L}_n \circ \mathbf{L}_m \left(\text{cup}(a) \right) &= \mathbf{L}_n \left(\nu_m \cdot \text{cup}(a, \spadesuit_m) - \nu_m \cdot \text{cup}(a, \spadesuit_0) + \frac{1}{2} \sum_{k+l=m} \text{cup}(a, \spadesuit_k \spadesuit_l) \right) \\ &= -m\nu_m \cdot \text{cup}(a, \spadesuit_0 \spadesuit_{m+n}) + m\nu_m \cdot \text{cup}(a, \spadesuit_{m+n} \spadesuit_0) - \frac{1}{2} \sum_{k+l=m} k \cdot \text{cup}(a, \spadesuit_{k+n} \spadesuit_l) + \ell \cdot \text{cup}(a, \spadesuit_k \spadesuit_{\ell+n}) \\ &\quad + \text{terms symmetric in } n \text{ and } m. \end{aligned}$$

The reader may have noticed that if $m = -1$, $\spadesuit_m = 0$ and therefore it is not true in this case that $L_n(\spadesuit_m) = -m\spadesuit_{m+n}$. However since $\nu_{-1} = 0$, the identity is also correct in this case. Similar phenomena happens when $m = 0$.

Hence we obtain:

$$(75) \quad \begin{aligned} [\mathbf{L}_n, \mathbf{L}_m] \left(\text{cup}(a) \right) &= (n\nu_n - m\nu_m) \cdot \text{cup}(a, \spadesuit_0 \spadesuit_{m+n}) - (n\nu_n - m\nu_m) \cdot \text{cup}(a, \spadesuit_{m+n} \spadesuit_0) \\ &\quad - \frac{1}{2} \sum_{k+l=m} k \cdot \text{cup}(a, \spadesuit_{k+n} \spadesuit_l) + \ell \cdot \text{cup}(a, \spadesuit_k \spadesuit_{\ell+n}) + \frac{1}{2} \sum_{k+l=n} k \cdot \text{cup}(a, \spadesuit_{k+m} \spadesuit_l) + \ell \cdot \text{cup}(a, \spadesuit_k \spadesuit_{\ell+n}). \end{aligned}$$

One has $(n\nu_n - m\nu_m) = (n - m)\nu_{n+m}$ because $(\nu_n)_{n \in \mathbb{N}_{-1}}$ is a Witt-sequence. Let us now deal the terms in the second line of (75). This is a linear combination of

$$x_{ij} := \text{cup}(a, \spadesuit_i \spadesuit_j)$$

where i and j are non-negative integers with $i + j = m + n$. We treat three cases: $0 \leq i \leq n$, $n < i < m$ and $m \leq i \leq m + n$.

- If $0 \leq i \leq n$, then $m \leq j \leq m + n$. In this case, the coefficient of x_{ij} is

$$\frac{1}{2}(-(j - n) + (j - m)) = \frac{n - m}{2}.$$

- If $n < i < m$, then $n < j < m$. In this case, the coefficient of x_{ij} is

$$\frac{1}{2}(-(i-n) - (j-n)) = \frac{2n - (i+j)}{2} = \frac{n-m}{2}.$$

- If $m \leq i \leq m+n$, then $0 \leq j \leq n$. In this case, the coefficient of x_{ij} is

$$\frac{1}{2}(-(i-n) + (i-m)) = \frac{n-m}{2}.$$

Hence we have:

$$(76) \quad [\mathbf{L}_n, \mathbf{L}_m] \left(\text{cup}(a) \right) = (n-m)\nu_{m+n} \cdot \text{cup}(a, \hat{\bullet}_0, \hat{\bullet}_{m+n}) - (n-m)\nu_{m+n} \cdot \text{cup}(a, \hat{\bullet}_{m+n}, \hat{\bullet}_0) \\ + \frac{n-m}{2} \sum_{i+j=m+n} k \cdot \text{cup}(a, \hat{\bullet}_i, \hat{\bullet}_j) \\ = (n-m)\mathbf{L}_{m+n} \left(\text{cup}(a) \right). \quad \square$$

Proposition 4.3. *Let F be a closed spherical foam in good position, then for all $n \in \mathbb{N}_{-1}$*

$$(77) \quad \langle \mathbf{L}_n \cdot F \rangle_N = \mathbf{L}_n \cdot \langle F \rangle_N.$$

Proof. Note that for all $n \in \mathbb{N}_{-1}$, $\mathbf{L}_n \cdot F$ is a (linear combination of) foam(s) which is (are) equal to F if we ignore the decorations. Hence the colorings of F are in 1-to-1 correspondence with the decorations of $\mathbf{L}_n \cdot F$. If c is a coloring of F , then the corresponding coloring of $\mathbf{L}_n \cdot F$ is still denoted c . For every coloring c of F , one has: $Q(\mathbf{L}_n(F), c) = Q(F, c)$ and $s(F, c) = s(\mathbf{L}_n(F), c)$. We will prove that:

$$(78) \quad \mathbf{L}_n \cdot \langle F, c \rangle_N = \langle \mathbf{L}_n \cdot F, c \rangle_N,$$

which then implies the proposition by summing over all colorings of F .

We compute:

$$(79) \quad \mathbf{L}_n \cdot \langle F, c \rangle_N = \mathbf{L}_n \cdot \left((-1)^{s(F,c)} \frac{P(F, c)}{Q(F, c)} \right) \\ = (-1)^{s(F,c)} \left(\frac{\mathbf{L}_n \cdot P(F, c)}{Q(F, c)} - \frac{P(F, c)(\mathbf{L}_n \cdot Q(F, c))}{Q(F, c)^2} \right).$$

We focus on $\mathbf{L}_n \cdot Q(F, c)$:

$$(80) \quad \mathbf{L}_n \cdot Q(F, c) = \mathbf{L}_n \cdot \left(\prod_{1 \leq i < j \leq N} (X_i - X_j)^{\chi(F_{ij}(c))/2} \right)$$

$$(81) \quad = - \sum_{1 \leq i < j \leq N} \frac{\chi(F_{ij}(c))}{2} \left(\sum_{k+\ell=n} p_k(X_i) p_\ell(X_j) Q(F, c) \right).$$

Finally we get:

$$(82) \quad \mathbf{L}_n \cdot \langle F, c \rangle_N = \frac{\mathbf{L}_n \cdot P(F, c) + \sum_{1 \leq i < j \leq N} \frac{\chi(F_{ij}(c))}{2} h_n(X_i, X_j) P(F, c)}{(-1)^{s(F,c)} Q(F, c)}.$$

Basic foam	Contribution to $R(F, c)$
	$s \sum_{i \in I} \sum_{j \in J} h_n(X_i, X_j) + \lambda_n p_n(\underline{X}_I) + \mu_n p_n(\underline{X}_J)$
	$\bar{s} \sum_{i \in I} \sum_{j \in J} h_n(X_i, X_j) - \lambda_n p_n(\underline{X}_I) - \mu_n p_n(\underline{X}_J)$
	$-\bar{s} \sum_{i \in I} \sum_{j \in J} h_n(X_i, X_j) + \lambda_n p_n(\underline{X}_I) + \mu_n p_n(\underline{X}_J)$
	$-s \sum_{i \in I} \sum_{j \in J} h_n(X_i, X_j) - \lambda_n p_n(\underline{X}_I) - \mu_n p_n(\underline{X}_J)$
	$\frac{1}{2} \sum_{i \in I} \sum_{j \notin I} h_n(X_i, X_j) - (N - a) \nu_n p_n(\underline{X}_I) + a \nu_n p_n(\underline{X}_{\hat{I}})$
	$\frac{1}{2} \sum_{i \in I} \sum_{j \notin I} h_n(X_i, X_j) + (N - a) \nu_n p_n(\underline{X}_I) - a \nu_n p_n(\underline{X}_{\hat{I}})$

TABLE 2. In this table, the blue hashed surface always has thickness a , the red dotted ones always has thickness b . We denote by $I \subseteq \mathbb{P}$, the color of facets with thickness a and by $J \subseteq \mathbb{P}$, the color of facets with thickness b for the coloring c . In particular, $\#I = a$, $\#J = b$ and $I \cap J = \emptyset$. Finally \underline{X}_I denotes $\{X_i | i \in I\}$ and $\hat{I} = \mathbb{P} \setminus I$.

We now look at $P(\mathbf{L}_n(F), c)$. Note that for each basic foam, $\mathbf{L}_n(F)$ is equal to F with some additional decorations. Due to the Leibniz rule used to define the operator \mathbf{L}_n , one has that:

$$(83) \quad P(\mathbf{L}_n(F), c) = \mathbf{L}_n(P(F, c)) + R(F, c)P(F, c)$$

with $R(F, c)$ a sum of polynomials, one for each basic foam, evaluated using the colors associated by c to the facets of these basic foams.

Table 2 summarizes the contributions to $R(F, c)$ of basic foams (with colorings).

Note that in Table 2, contributions to R always consist of sums of polynomials of the form $\sum_{k+\ell=n} p_k(X_i) p_\ell(X_j) = X_i^k X_j^\ell = h_n(X_i, X_j)$ for some $1 \leq i < j \leq N$ and of the form $p_n(X_i)$ for some $1 \leq i \leq N$. Let us write⁷:

$$R(F, c) = \sum_{i=1}^N r_i p_n(X_i) + \sum_{1 \leq i < j \leq N} r_{ij} h_n(X_i, X_j).$$

The polynomials $p_n(X_i)$ and $h_n(X_i, X_j)$ appear in the contribution to $R(F, c)$ of a basic foam precisely when this basic foam contributes to U_{ij} , U_{ji} , A_{ij} , A_{ji} , V_{ij} , V_{ji} , Λ_{ij} , Λ_{ji} , Z_{ij} , Z_{ji} , Y_{ij} or Y_{ji} . More precisely, one has:

⁷If $n = 1$, this decomposition is not unique since $h_1(X_i, X_j) = p_1(X_i) + p_1(X_j)$. However in what follows, we can think of n as a purely formal variable, so that the decomposition is well-defined.

$$(84) \quad \begin{aligned} r_{ij} = & s(V_{ij} + V_{ji} - Y_{ij} - Y_{ji}) + \bar{s}(\Lambda_{ij} + \Lambda_{ji} - Z_{ij} - Z_{ji}) \\ & + \frac{1}{2}(U_{ij} + U_{ji} + A_{ij} + A_{ji}), \end{aligned}$$

$$(85) \quad \begin{aligned} r_i = & \sum_{j \neq i} \left(\lambda_n(V_{ij} + Z_{ij} - \Lambda_{ij} - Y_{ij}) + \mu_n(V_{ji} + Z_{ji} - \Lambda_{ji} - Y_{ji}) \right. \\ & \left. + \nu_n(A_{ij} - A_{ji} - U_{ij} + U_{ji}) \right). \end{aligned}$$

Using Lemmas 2.17 and 2.18, we conclude that for all $1 \leq i \leq N$, $r_i = 0$ and that for all $1 \leq i < j \leq N$, $r_{ij} = \frac{\chi(F_{ij}(c))}{2}$. In summary, this means that:

$$(86) \quad P(\mathbf{L}_n(F), c) = \mathbf{L}_n \cdot P(F, c) + \sum_{1 \leq i < j \leq N} \frac{\chi(F_{ij}(c))}{2} h_n(X_i, X_j) P(F, c).$$

Finally, we conclude

$$(87) \quad \begin{aligned} \langle \mathbf{L}_n(F), c \rangle_N &= \frac{\mathbf{L}_n \cdot P(F, c) + \sum_{1 \leq i < j \leq N} \frac{\chi(F_{ij}(c))}{2} h_n(X_i, X_j) P(F, c)}{(-1)^{s(F,c)} Q(F, c)} \\ &= \mathbf{L}_n \cdot \langle F, c \rangle_N. \end{aligned} \quad \square$$

Theorem 4.4. *For any web Γ , the operators $(\mathbf{L}_n)_{n \in \mathbb{N}_{-1}}$ induce an action of \mathfrak{W}_{-1}^∞ on the equivariant state space ${}^E\mathcal{F}_N^{\mathbf{k},s}(\Gamma)$.*

Proof. We need to prove that if a $\mathbb{k}[X_1, \dots, X_N]$ -linear combination $\sum_i \lambda_i F_i$ of spherical Γ -foams in good position is equal to 0 in $\langle \Gamma \rangle_N^s$, then for all $n \in \mathbb{N}_{-1}$,

$$(88) \quad \mathbf{L}_n \cdot \left(\sum_i \lambda_i F_i \right) := \sum_i (\mathbf{L}_n \cdot \lambda_i) F_i + \sum_i \lambda_i \mathbf{L}_n(F_i)$$

is equal to 0 in $\langle \Gamma \rangle_N^s$. In other words, we need to prove that for any spherical foam $G: \Gamma \rightarrow \emptyset$, that $\sum_i \lambda_i \langle G \circ \mathbf{L}_n(F_i) \rangle_N + \sum_i (\mathbf{L}_n \cdot \lambda_i) \langle G \circ F_i \rangle_N = 0$. This is a direct consequence of Proposition 4.3. Indeed, since $\sum_i \lambda_i F_i = 0$, one has

$$(89) \quad \mathbf{L}_n \cdot \left(\sum_i \lambda_i \langle G \circ F_i \rangle_N \right) = \sum_i (\mathbf{L}_n \lambda_i) \langle G \circ F_i \rangle_N + \sum_i \lambda_i \langle \mathbf{L}_n(G) \circ F_i \rangle_N$$

$$(90) \quad + \sum_i \lambda_i \langle G \circ \mathbf{L}_n(F_i) \rangle_N$$

and $\sum_i \lambda_i \langle \mathbf{L}_n(G) \circ F_i \rangle_N = 0$. From this we deduce that

$$(91) \quad \sum_i \lambda_i \langle G \circ \mathbf{L}_n(F_i) \rangle_N + \sum_i (\mathbf{L}_n \cdot \lambda_i) \langle G \circ F_i \rangle_N = 0$$

as desired. □

Example 4.5. Let us explain how to compute the action of \mathbf{L}_n on the following piece of foam.

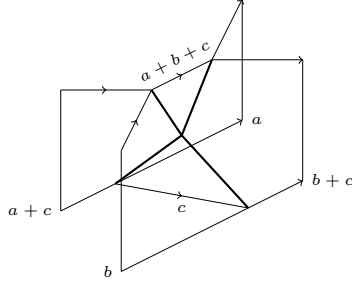

This foam is *not* in good position, so we first isotope it slightly. As such, it appears as a composition, that we represent as a movie.

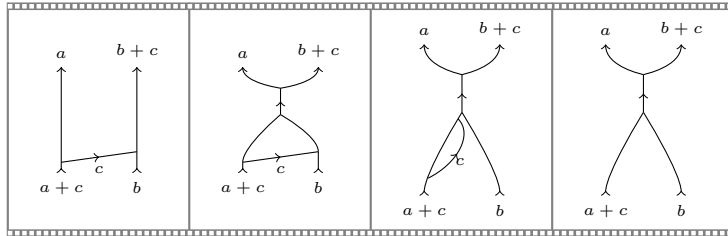

Now we can use equations (66), (63) and (65) to compute the action of \mathbf{L}_n . Isotoping back and using the dot migration (see (61)) we obtain:

$$\begin{aligned}
 & (92) \quad \left(\begin{array}{c} \text{Foam Diagram} \\ \mathbf{L}_n \end{array} \right) = \lambda_n \left(\begin{array}{c} \text{Foam Diagram with dots} \\ \mathbf{L}_n \end{array} \right) \\
 & (93) \quad + \mu_n \left(\begin{array}{c} \text{Foam Diagram with dots} \\ \mathbf{L}_n \end{array} \right) - \bar{s} \sum_{k+\ell=n} \left(\begin{array}{c} \text{Foam Diagram with dots} \\ \mathbf{L}_n \end{array} \right) .
 \end{aligned}$$

4.2. Action of \mathfrak{sl}_2 . Lemma 3.6 gives an embedding of \mathfrak{sl}_2 in \mathfrak{W}_{-1}^∞ . Hence the action of \mathfrak{W}_{-1}^∞ defined above induces an action of \mathfrak{sl}_2 on \mathfrak{gl}_N -foams. Some of the parameters used before become redundant and the necessity of inverting 2 vanishes. We include formula for the action of \mathbf{e} , \mathbf{f} and \mathbf{h} (via some operators denoted by \mathbf{e} , \mathbf{f} and \mathbf{h}). They can of course be deduced from the ones in Section 4.1 via the injection of Lemma 3.6. Fix three parameters t_1, t_2 and t_3 .

As before, \mathbf{e} , \mathbf{f} and \mathbf{h} satisfy the Leibniz rule with respect to composition of foams and map traces of isotopies to 0. The operator \mathbf{e} acts via \mathbf{L}_{-1} on polynomials and

by 0 on any other basic foam. The operator \mathbf{h} is defined as follows.

$$(94) \quad \mathbf{h} \left(\begin{array}{|c|} \hline \bullet \\ \hline R \\ \hline \end{array} \right) = -\deg(R) \cdot \begin{array}{|c|} \hline \bullet \\ \hline R \\ \hline \end{array}$$

$$(95) \quad \mathbf{h} \left(\begin{array}{|c|} \hline \begin{array}{c} \text{Diagram with } a, b, c \text{ and } a+b+c \end{array} \\ \hline \end{array} \right) = \mathbf{h} \left(\begin{array}{|c|} \hline \begin{array}{c} \text{Diagram with } a+b+c, a, b, c \end{array} \\ \hline \end{array} \right) = 0$$

$$(96) \quad \mathbf{h} \left(\begin{array}{|c|} \hline \begin{array}{c} \text{Diagram with } a, b, a+b \end{array} \\ \hline \end{array} \right) = ab(t_1 + t_2) \cdot \begin{array}{|c|} \hline \begin{array}{c} \text{Diagram with } a, b, a+b \end{array} \\ \hline \end{array}$$

$$(97) \quad \mathbf{h} \left(\begin{array}{|c|} \hline \begin{array}{c} \text{Diagram with } a, b, a+b \end{array} \\ \hline \end{array} \right) = ab(\bar{t}_1 + \bar{t}_2) \cdot \begin{array}{|c|} \hline \begin{array}{c} \text{Diagram with } a, b, a+b \end{array} \\ \hline \end{array}$$

$$(98) \quad \mathbf{h} \left(\begin{array}{|c|} \hline \begin{array}{c} \text{Diagram with } a+b, a, b \end{array} \\ \hline \end{array} \right) = -ab(\bar{t}_1 + \bar{t}_2) \cdot \begin{array}{|c|} \hline \begin{array}{c} \text{Diagram with } a+b, a, b \end{array} \\ \hline \end{array}$$

$$(99) \quad \mathbf{h} \left(\begin{array}{|c|} \hline \begin{array}{c} \text{Diagram with } a, b, a+b \end{array} \\ \hline \end{array} \right) = -ab(t_1 + t_2) \cdot \begin{array}{|c|} \hline \begin{array}{c} \text{Diagram with } a, b, a+b \end{array} \\ \hline \end{array}$$

$$(100) \quad \mathbf{h} \left(\begin{array}{|c|} \hline \begin{array}{c} \text{Diagram with } a \end{array} \\ \hline \end{array} \right) = 2a(N - a)t_3 \cdot \begin{array}{|c|} \hline \begin{array}{c} \text{Diagram with } a \end{array} \\ \hline \end{array}$$

$$(101) \quad \mathbf{h} \left(\begin{array}{|c|} \hline \begin{array}{c} \text{Diagram with } a \end{array} \\ \hline \end{array} \right) = 2a(N - a)\bar{t}_3 \cdot \begin{array}{|c|} \hline \begin{array}{c} \text{Diagram with } a \end{array} \\ \hline \end{array}$$

Finally \mathbf{f} is given as follows.

$$(102) \quad \mathbf{f} \left(\begin{array}{|c|} \hline \bullet \\ \hline R \\ \hline \end{array} \right) = - \begin{array}{|c|} \hline \bullet \\ \hline \mathbf{L}_1(R) \\ \hline \end{array}$$

$$(103) \quad \mathbf{f} \left(\begin{array}{|c|} \hline \begin{array}{c} \text{Diagram with } a, b, c \text{ and } a+b+c \end{array} \\ \hline \end{array} \right) = \mathbf{f} \left(\begin{array}{|c|} \hline \begin{array}{c} \text{Diagram with } a+b+c, a, b, c \end{array} \\ \hline \end{array} \right) = 0$$

$$(104) \quad \mathbf{f} \left(\begin{array}{|c|} \hline \begin{array}{c} \text{Diagram with } a, b, a+b \end{array} \\ \hline \end{array} \right) = -t_1 \cdot \begin{array}{|c|} \hline \begin{array}{c} \text{Diagram with } a, b, a+b \text{ and blue dots } \bullet_1, \bullet_0 \end{array} \\ \hline \end{array} - t_2 \cdot \begin{array}{|c|} \hline \begin{array}{c} \text{Diagram with } a, b, a+b \text{ and blue dots } \bullet_0, \bullet_1 \end{array} \\ \hline \end{array}$$

$$(105) \quad \mathbf{f} \left(\begin{array}{c} \text{[Diagram: A square with a semi-circle on top. The bottom edge is split into segments of length } a \text{ and } b. \text{ Arrows point right on the bottom edge.]} \\ \end{array} \right) = -\bar{t}_1 \cdot \begin{array}{c} \text{[Diagram: Same as (105) but with a blue dot labeled } \hat{1} \text{ on the top arc and a blue dot labeled } \hat{0} \text{ on the bottom edge.]} \\ \end{array} - \bar{t}_2 \cdot \begin{array}{c} \text{[Diagram: Same as (105) but with a blue dot labeled } \hat{0} \text{ on the top arc and a blue dot labeled } \hat{1} \text{ on the bottom edge.]} \\ \end{array}$$

$$(106) \quad \mathbf{f} \left(\begin{array}{c} \text{[Diagram: A square with a semi-circle on top. The top edge is split into segments of length } a \text{ and } b. \text{ Arrows point right on the top edge.]} \\ \end{array} \right) = \bar{t}_1 \cdot \begin{array}{c} \text{[Diagram: Same as (106) but with a blue dot labeled } \hat{1} \text{ on the top arc and a blue dot labeled } \hat{0} \text{ on the top edge.]} \\ \end{array} + \bar{t}_2 \cdot \begin{array}{c} \text{[Diagram: Same as (106) but with a blue dot labeled } \hat{0} \text{ on the top arc and a blue dot labeled } \hat{1} \text{ on the top edge.]} \\ \end{array}$$

$$(107) \quad \mathbf{f} \left(\begin{array}{c} \text{[Diagram: A square with a semi-circle on bottom. The bottom edge is split into segments of length } a \text{ and } b. \text{ Arrows point right on the bottom edge.]} \\ \end{array} \right) = t_1 \cdot \begin{array}{c} \text{[Diagram: Same as (107) but with a blue dot labeled } \hat{1} \text{ on the bottom arc and a blue dot labeled } \hat{0} \text{ on the bottom edge.]} \\ \end{array} + t_2 \cdot \begin{array}{c} \text{[Diagram: Same as (107) but with a blue dot labeled } \hat{0} \text{ on the bottom arc and a blue dot labeled } \hat{1} \text{ on the bottom edge.]} \\ \end{array}$$

$$(108) \quad \mathbf{f} \left(\begin{array}{c} \text{[Diagram: A semi-circle with diameter } a. \text{ Arrows point right on the diameter.]} \\ \end{array} \right) = -t_3 \cdot \begin{array}{c} \text{[Diagram: Same as (108) but with blue dots } \hat{0} \text{ and } \hat{1} \text{ on the diameter.]} \\ \end{array} - \bar{t}_3 \cdot \begin{array}{c} \text{[Diagram: Same as (108) but with blue dots } \hat{1} \text{ and } \hat{0} \text{ on the diameter.]} \\ \end{array}$$

$$(109) \quad \mathbf{f} \left(\begin{array}{c} \text{[Diagram: A semi-circle with diameter } a. \text{ Arrows point left on the diameter.]} \\ \end{array} \right) = -\bar{t}_3 \cdot \begin{array}{c} \text{[Diagram: Same as (109) but with blue dots } \hat{0} \text{ and } \hat{1} \text{ on the diameter.]} \\ \end{array} - t_3 \cdot \begin{array}{c} \text{[Diagram: Same as (109) but with blue dots } \hat{1} \text{ and } \hat{0} \text{ on the diameter.]} \\ \end{array}$$

Note that using the embedding of \mathfrak{sl}_2 in \mathfrak{W}_{-1}^∞ of Lemma 3.6, the relations between s , λ , μ and ν are given by:

$$(110) \quad t_1 = \lambda_1 + s, \quad t_2 = \mu_1 + s, \quad \text{and} \quad t_3 = \nu_1 + \frac{1}{2}.$$

The same proof as that of Lemma 4.2 gives the following.

Lemma 4.6. *Mapping e to \mathbf{e} , h to \mathbf{h} and f to \mathbf{f} defines an action of \mathfrak{sl}_2 on the \mathbb{k} -module generated by spherical foams in good position.*

The same proof as that of Theorem 4.4 gives the following.

Proposition 4.7. *For any web Γ , the operators $\{\mathbf{e}, \mathbf{h}, \mathbf{f}\}$ induce an action of \mathfrak{sl}_2 on ${}^E\mathcal{F}_N^{\mathbb{k},s}(\Gamma)$.*

Remark 4.8. In contrast with the operators \mathbf{L}_n , the definition of the action of \mathbf{e} , \mathbf{h} and \mathbf{f} , do not require 2 to be invertible in \mathbb{k} . Lemma 4.6 and Proposition 4.7 remain valid without this assumption.

4.3. p -DG structure. In this section, we fix p a prime number and we assume that $\mathbb{k} = \mathbb{F}_p$. We aim to endow \mathfrak{gl}_N -state spaces with a p -DG-structure, that is an H -module structure (see Section 3.3). Namely, we will establish the following proposition.

Proposition 4.9. *For any web Γ , mapping ∂ to \mathbf{f} endows the state space ${}^E\mathcal{F}_N^{\mathbb{F}_p,s}(\Gamma)$ with an H -module structure.*

In what follows, we will denote \mathbf{f} by ∂ in order to facilitate the reading.

Proof. We already know that the action of ∂ on $\mathcal{F}_N^s(\Gamma)$ is well-defined. We only need to show that ∂^p acts trivially on ${}^E\mathcal{F}_N^{\mathbb{F}_p,s}(\Gamma)$. By the Leibniz rule, in characteristic p , it suffices to show that $\partial^p(F) = 0$ for any basic foam.

For traces of isotopies, associativity and coassociativity, this is obvious since ∂ acts trivially on these basic foams. For polynomials, this follows from the computation $\partial^p(z) = p!z^{p+1} = 0$. We now consider the remaining basic foams. The

computations for all of these are similar and can be done as in the proof [QRSW21, Lemma 3.10]. We give here an alternative approach and focus first on the the digon-cup. Denote $\mathbb{F}_p[x_1, \dots, x_a, y_1, \dots, y_b]^{S_a \times S_b}$ by $A_{(a,b)}$, and consider the set M of linear combinations of foams which are decorated, (we restrict here to “classical” decorations)

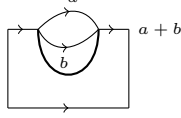

up to dot migration (see Example 2.20). Since dot migration is a local relation in state space, it is enough to show that ∂^p acts trivially on M . The \mathbb{F}_p -module M is naturally endowed with an $A_{(a,b)}$ -module structure where symmetric polynomials in the first a variables act on the a -thick facet and polynomials in the last b variables act on the b -thick facet. The module M is free of rank one and has a generator 1_M which is the foam

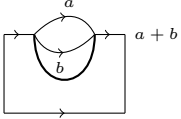

For $P \in A_{(a,b)}$, the element $P \cdot 1_M$ of M is denoted P_M . Recall that $A_{(a,b)}$ is endowed with an H -module structure by setting

$$(111) \quad \partial(P) = \mathbf{f}(P) = \sum_{i=1}^a x_i^2 \frac{\partial}{\partial x_i} P + \sum_{i=1}^b y_i^2 \frac{\partial}{\partial y_i} P.$$

We endow M with an H' -module structure by imposing

$$(112) \quad \partial(P_M) = \partial(P) - (bt_1 p_1(x_1, \dots, x_a) + at_2 p_1(y_1, \dots, y_b)) P.$$

In other words, the action of ∂ on M is that on $A_{(a,b)}$ twisted by

$$-(bt_1 p_1(x_1, \dots, x_a) + at_2 p_1(y_1, \dots, y_b)).$$

Thus, the twist we imposed on M precisely matches the definition of $\partial = \mathbf{f}$ on this basic foam. Hence proving that $\partial^p(1_M) = 0$ is enough for our purposes. The fact that $\partial^p(1_M) = 0$ follows directly from Lemma 3.4 and Remark 3.5.

The analysis for the other basic foams is similar. However note that for cups and caps, one considers the algebra $A_{(a, N-a)}$. \square

In contrast with other actions we have discussed so far, this extends to the non-equivariant setting. See [Wan21, Proposition 3.8] for conditions where the action of \mathbf{e} extends in the non-equivariant setting.

Corollary 4.10. *For any web Γ , mapping ∂ to \mathbf{f} endows the state space ${}^0\mathcal{F}_N^{\mathbb{F}_p, s}(\Gamma)$ with an H -module structure.*

Proof. In order to prove that the action of ∂ is well-defined on ${}^0\mathcal{F}_N^{\mathbb{F}_p, s}(\Gamma)$, one should prove that if a (linear combination of) spherical foam(s) F is equal to 0 in ${}^0\mathcal{F}_N^{\mathbb{F}_p, s}(\Gamma)$, then $\partial(F) = 0$ in ${}^0\mathcal{F}_N^{\mathbb{F}_p, s}(\Gamma)$. We will prove the contrapositive. Suppose that $\partial F \neq 0$ in ${}^0\mathcal{F}_N^{\mathbb{F}_p, s}(\Gamma)$. This means that there exists a spherical foam $G: \Gamma \rightarrow \emptyset$ such that $\varphi_0(\langle G \circ \partial(F) \rangle) \neq 0 \in \mathbb{F}_p$, where $\varphi_0: R_N \rightarrow \mathbb{F}_p$ is the unique ring morphism mapping E_i to 0 for all $1 \leq i \leq N$. We can suppose that both F and G are homogeneous. Since $\varphi_0(\langle G \circ \partial(F) \rangle) \neq 0$ and ∂ is of degree 2, one necessarily has $\deg(F) + \deg(G) = -2$. In particular $\langle G \circ F \rangle = 0$. The Leibniz rule (in $(\mathbb{F}_p)_N$) implies that $\langle G \circ \partial(F) \rangle = -\langle \partial(G) \circ F \rangle$ and therefore that $\varphi_0(\langle \partial(G) \circ F \rangle) \neq 0$ and finally that F is not zero in ${}^0\mathcal{F}_N^{\mathbb{F}_p, s}(\Gamma)$. \square

4.4. **Saddles.** When dropping the spherical conditions on foams, Lemma 2.16 is not valid anymore and this forces us to set $\nu_n = 0$ for all $n \in \mathbb{N}_{-1}$ (or $t_3 = \frac{1}{2}$ for the \mathfrak{sl}_2 and p -DG cases). Therefore there is no option but to invert 2 in order to have an \mathfrak{sl}_2 -action or a p -DG structure on state spaces. We give details below.

For $n \in \mathbb{N}_{-1}$, define

$$(113) \quad \mathbf{L}_n \left(\begin{array}{c} a \\ \text{Saddle} \end{array} \right) = -\frac{1}{2} \sum_{k+\ell=n} \begin{array}{c} a \\ \text{Saddle} \\ \clubsuit_k \quad \clubsuit_\ell \end{array}$$

$$(114) \quad \mathbf{L}_n \left(\begin{array}{c} a \\ \text{Cap} \end{array} \right) = \frac{1}{2} \sum_{k+\ell=n} \begin{array}{c} a \\ \text{Cap} \\ \clubsuit_k \quad \clubsuit_\ell \end{array}$$

$$(115) \quad \mathbf{L}_n \left(\begin{array}{c} \text{Cap} \\ a \end{array} \right) = \frac{1}{2} \sum_{k+\ell=n} \begin{array}{c} \text{Cap} \\ a \\ \clubsuit_k \quad \clubsuit_\ell \end{array}$$

and recycle the definition of \mathbf{L}_n on other basic foams given by (62)–(67).

The same proofs as those of Lemma 4.2 and Theorem 4.4 give the following proposition.

Proposition 4.11. *For any web Γ , mapping \mathbf{L}_n to \mathbf{L}_n defines an action of \mathfrak{W}_{-1}^∞ on the not necessarily spherical state space ${}^E\mathcal{F}_N^k(\Gamma)$.*

Define

$$(116) \quad \mathbf{e} \left(\begin{array}{c} a \\ \text{Saddle} \end{array} \right) = \mathbf{e} \left(\begin{array}{c} a \\ \text{Cap} \end{array} \right) = \mathbf{e} \left(\begin{array}{c} \text{Cap} \\ a \end{array} \right) = 0,$$

$$(117) \quad \mathbf{f} \left(\begin{array}{c} a \\ \text{Saddle} \end{array} \right) = \frac{1}{2} \cdot \begin{array}{c} a \\ \text{Saddle} \\ \clubsuit_0 \quad \clubsuit_1 \end{array} + \frac{1}{2} \cdot \begin{array}{c} a \\ \text{Saddle} \\ \clubsuit_1 \quad \clubsuit_0 \end{array},$$

$$(118) \quad \mathbf{f} \left(\begin{array}{c} a \\ \text{Cap} \end{array} \right) = -\frac{1}{2} \cdot \begin{array}{c} a \\ \text{Cap} \\ \clubsuit_0 \quad \clubsuit_1 \end{array} - \frac{1}{2} \cdot \begin{array}{c} a \\ \text{Cap} \\ \clubsuit_1 \quad \clubsuit_0 \end{array},$$

$$(119) \quad \mathbf{f} \left(\begin{array}{c} \text{Cap} \\ a \end{array} \right) = -\frac{1}{2} \cdot \begin{array}{c} \text{Cap} \\ a \\ \clubsuit_0 \quad \clubsuit_1 \end{array} - \frac{1}{2} \cdot \begin{array}{c} \text{Cap} \\ a \\ \clubsuit_1 \quad \clubsuit_0 \end{array},$$

$$(120) \quad \mathbf{h} \left(\begin{array}{c} a \\ \text{Saddle} \end{array} \right) = -a(N-a) \cdot \begin{array}{c} a \\ \text{Saddle} \end{array},$$

$$(121) \quad \mathbf{h} \left(\begin{array}{c} a \\ \text{Cap} \end{array} \right) = a(N-a) \cdot \begin{array}{c} a \\ \text{Cap} \end{array},$$

$$(122) \quad \mathbf{h} \left(\begin{array}{c} \text{Cap} \\ a \end{array} \right) = a(N-a) \cdot \begin{array}{c} \text{Cap} \\ a \end{array},$$

and recycle the definition of \mathbf{e} , \mathbf{f} and \mathbf{h} on other basic foams given by (102)–(107).

Again, the same proofs as those of Lemma 4.2, Theorem 4.4 and Corollary 4.10 give the following.

Proposition 4.12. *For any web Γ , mapping \mathbf{e}, \mathbf{f} and \mathbf{h} to \mathbf{e}, \mathbf{f} and \mathbf{h} respectively defines an action of \mathfrak{sl}_2 on the not necessarily spherical state space ${}^E\mathcal{F}_N^{\mathbf{k}}(\Gamma)$.*

Proposition 4.13. *Let $p > 2$ be a prime number. For any web Γ , mapping ∂ to \mathbf{f} endows the state space ${}^E\mathcal{F}_N^{\mathbb{F}_p}(\Gamma)$ with an H -module structure.*

Corollary 4.14. *Let $p > 2$ be a prime number. For any web Γ , mapping ∂ to \mathbf{f} endows the state space ${}^0\mathcal{F}_N^{\mathbb{F}_p}(\Gamma)$ with an H -module structure.*

Remark 4.15. If Γ_1 and Γ_2 are two webs, then since ${}^E\mathcal{F}_N^{\mathbf{k}}$ is monoidal, ${}^E\mathcal{F}_N^{\mathbf{k}}(\Gamma_1 \sqcup \Gamma_2)$ is naturally isomorphic to ${}^E\mathcal{F}_N^{\mathbf{k}}(\Gamma_1) \otimes {}^E\mathcal{F}_N^{\mathbf{k}}(\Gamma_2)$. Then by its very construction, the action of \mathfrak{W}_{-1}^∞ on ${}^E\mathcal{F}_N^{\mathbf{k}}(\Gamma_1 \sqcup \Gamma_2)$ satisfies the Leibniz rule in the sense that for any $n \in \mathbb{N}_{-1}$ and any $F_1 \otimes F_2$ in ${}^E\mathcal{F}_N^{\mathbf{k}}(\Gamma_1) \otimes {}^E\mathcal{F}_N^{\mathbf{k},s}(\Gamma_2)$,

$$\mathbf{L}_n \cdot (F_1 \otimes F_2) = (\mathbf{L}_n \cdot F_1) \otimes F_2 + F_1 \otimes (\mathbf{L}_n \cdot F_2).$$

The same is true for the action of \mathfrak{sl}_2 and for that of H .

4.5. Related work. The aim of this section is to state how to tune parameters to recover structures already present in the literature in the context of Soergel bimodules and their Hochschild homologies. Since the equivalence of bi-categories between Soergel bimodules (in type A) and foams subject to ad-hoc relations is not formally established yet (details will appear in [KRW22]), we do not aim to be very precise here. In the context of Soergel bimodules, there are no saddles nor caps nor cups. So namely we have to deal with parameters s, λ, μ for \mathfrak{W}_{-1}^∞ and t_1 and t_2 for \mathfrak{sl}_2 . In the context of Soergel bimodules, the zip and unzip foams correspond to bimodule homomorphisms, that are typically denoted by rb and br respectively.

We spotted three places with various conventions [KR16], [EQ20, EQ21] and [QS20, QRSW21] which fit into this context.

As already mentioned, Khovanov and Rozansky [KR16] exhibited a (half) Witt action on triply-graded link homology. They use a slightly different presentation of the Witt algebra ($\mathbf{L}_n^{\text{[KR16]}} \leftrightarrow -\mathbf{L}_n$). The maps rb and br are denoted χ_+ and χ_- respectively (see [KR16, Equation (3.8)]). The fact that the map χ_- has no twist in its definition, corresponds to the choice $\lambda_n = \mu_n = s = 0$ for all $n \in \mathbb{N}_{-1}$.

The structures considered in [EQ20, EQ21] deal with more general Soergel bimodules than the type A Soergel bimodules to which we can relate to with foams. Elias and Qi endow these general Soergel bimodules with an \mathfrak{sl}_2 action (in their language, $\mathbf{e} = \mathbf{d}$ and $\mathbf{f} = \mathbf{z}$). Restricting to the type A case, the formulas [EQ21, Equations (4.1a–i)] correspond to the setting $t_1 = 1$ and $t_2 = 0$.

The papers [QS20, QRSW21] are only concerned with p -DG structure. The absence of twist in formula of [QS20, Lemma 3.3 (ii)] corresponds to setting $t_1 = t_2 = 0$.

REFERENCES

- [BC18] Anna Beliakova and Benjamin Cooper. Steenrod structures on categorified quantum groups. *Fund. Math.*, 241(2):179–207, 2018. [arXiv:1304.7152](#), [doi:10.4064/fm307-3-2017](#).
- [BHMV95] Christian Blanchet, Nathan Habegger, Gregor Masbaum, and Pierre Vogel. Topological quantum field theories derived from the Kauffman bracket. *Topology*, 34(4):883–927, 1995. [doi:10.1016/0040-9383\(94\)00051-4](#).
- [BN05] Dror Bar-Natan. Khovanov’s homology for tangles and cobordisms. *Geom. Topol.*, 9:1443–1499, 2005. [arXiv:math/0410495](#), [doi:10.2140/gt.2005.9.1443](#).
- [BPRW21] Anna Beliakova, Krzysztof Putyra, Louis-Hadrien Robert, and Emmanuel Wagner. Algebraic versus geometric categorification of the Alexander polynomial: a spectral sequence, 2021. [arXiv:2112.02428](#).

- [Cau17] Sabin Cautis. Remarks on coloured triply graded link invariants. *Algebr. Geom. Topol.*, 17(6):3811–3836, 2017. [arXiv:1611.09924](#), [doi:10.2140/agt.2017.17.3811](#).
- [CF94] Louis Crane and Igor B. Frenkel. Four dimensional topological quantum field theory, Hopf categories, and the canonical bases. *J. Math. Phys.*, 35(10):5136–5154, 1994. [arXiv:hep-th/9405183](#), [doi:10.1063/1.530746](#).
- [Eli21] Ben Elias. $\mathfrak{sl}(2)$ action on Soergel bimodules, 2021. Talk at ICERM. URL: <https://icerm.brown.edu/events/htw-21-fe/#schedule-item-3365>.
- [EQ16] Ben Elias and You Qi. A categorification of quantum $\mathfrak{sl}(2)$ at prime roots of unity. *Adv. Math.*, 299:863–930, 2016. [arXiv:1503.05114](#), [doi:10.1016/j.aim.2016.06.002](#).
- [EQ20] Ben Elias and You Qi. Categorifying Hecke algebras at prime roots of unity, part I, 2020. [arXiv:2005.03128](#).
- [EQ21] Ben Elias and You Qi. Actions of \mathfrak{sl}_2 on algebras appearing in categorification, 2021. [arXiv:2103.00048](#).
- [ETW18] Michael Ehrig, Daniel Tubbenhauer, and Paul Wedrich. Functoriality of colored link homologies. *Proc. Lond. Math. Soc. (3)*, 117(5):996–1040, 2018. [arXiv:1703.06691](#), [doi:10.1112/plms.12154](#).
- [Kho00] Mikhail Khovanov. A categorification of the Jones polynomial. *Duke Math. J.*, 101(3):359–426, 2000. [arXiv:math/9908171](#), [doi:10.1215/S0012-7094-00-10131-7](#).
- [Kho07] Mikhail Khovanov. Triply-graded link homology and Hochschild homology of Soergel bimodules. *Internat. J. Math.*, 18(8):869–885, 2007. [arXiv:math/0510265](#), [doi:10.1142/S0129167X07004400](#).
- [Kho12] Mikhail Khovanov. One-half of the Witt algebra in categorification of quantum groups, 2012. Unpublished notes.
- [Kho16] Mikhail Khovanov. Hopfological algebra and categorification at a root of unity: The first steps. *J. Knot Theory Ramifications*, 25(3):359–426, 2016. [arXiv:math/0509083](#), [doi:10.1142/S021821651640006X](#).
- [KQ15] Mikhail Khovanov and You Qi. An approach to categorification of some small quantum groups. *Quantum Topol.*, 6(2):185–311, 2015. [arXiv:1208.0616](#), [doi:10.4171/QT/63](#).
- [KR08a] Mikhail Khovanov and Lev Rozansky. Matrix factorizations and link homology. *Fund. Math.*, 199(1):1–91, 2008. [arXiv:math/0401268](#), [doi:10.4064/fm199-1-1](#).
- [KR08b] Mikhail Khovanov and Lev Rozansky. Matrix factorizations and link homology. II. *Geom. Topol.*, 12(3):1387–1425, 2008. [arXiv:math/0505056](#), [doi:10.2140/gt.2008.12.1387](#).
- [KR16] Mikhail Khovanov and Lev Rozansky. Positive half of the Witt algebra acts on triply graded link homology. *Quantum Topol.*, 7(4):737–795, 2016. [arXiv:1305.1642](#), [doi:10.4171/QT/84](#).
- [KRW22] Mikhail Khovanov, Louis-Hadrien Robert, and Emmanuel Wagner. Soergel bimodules, Hochschild homology and foams, 2022. In preparation.
- [OS04] Peter Ozsváth and Zoltán Szabó. Holomorphic disks and knot invariants. *Adv. Math.*, 186(1):58–116, 2004. [arXiv:math/0209056](#), [doi:10.1016/j.aim.2003.05.001](#).
- [Qi14] You Qi. Hopfological algebra. *Compos. Math.*, 150(01):1–45, 2014. [arXiv:1205.1814](#), [doi:10.1112/S0010437X13007380](#).
- [QR16] Hoel Queffelec and David E. V. Rose. The \mathfrak{sl}_n foam 2-category: a combinatorial formulation of Khovanov–Rozansky homology via categorical skew Howe duality. *Adv. Math.*, 302:1251–1339, 2016. [arXiv:1405.5920](#), [doi:10.1016/j.aim.2016.07.027](#).
- [QRS18] Hoel Queffelec, David E. V. Rose, and Antonio Sartori. Annular evaluation and link homology, 2018. [arXiv:1802.04131](#).
- [QRSW21] You Qi, Louis-Hadrien Robert, Joshua Sussan, and Emmanuel Wagner. A categorification of the colored Jones polynomial at a root of unity, 2021. [arXiv:2111.13195](#).
- [QRSW22] You Qi, Louis-Hadrien Robert, Joshua Sussan, and Emmanuel Wagner. Symmetries of exterior \mathfrak{gl}_n link homology, 2022. In preparation.
- [QS17] You Qi and Joshua Sussan. Categorification at prime roots of unity and hopfological finiteness. In *Categorification and higher representation theory*, volume 683 of *Contemp. Math.*, pages 261–286. Amer. Math. Soc., Providence, RI, 2017. [arXiv:1509.00438](#), [doi:10.1090/conm/683](#).
- [QS20] You Qi and Joshua Sussan. On some p -differential graded link homologies, 2020. [arXiv:2009.06498](#).
- [Ras03] Jacob Andrew Rasmussen. *Floer homology and knot complements*. ProQuest LLC, Ann Arbor, MI, 2003. Thesis (Ph.D.)—Harvard University. [arXiv:math/0306378](#).
- [Rou17] Raphaël Rouquier. Khovanov–Rozansky homology and 2-braid groups. In *Categorification and higher representation theory*, volume 683 of *Contemp. Math.*, pages 141–147. Amer. Math. Soc., Providence, RI, 2017. [arXiv:1203.5065](#), [doi:10.1090/conm/683](#).

- [RT91] Nikolai Y. Reshetikhin and Vladimir G. Turaev. Invariants of 3-manifolds via link polynomials and quantum groups. *Invent. Math.*, 103(3):547–597, 1991. doi:10.1007/BF01239527.
- [RW19] Louis-Hadrien Robert and Emmanuel Wagner. A quantum categorification of the Alexander polynomial. *To appear in Geom. Topol.*, 2019. arXiv:1902.05648.
- [RW20a] Louis-Hadrien Robert and Emmanuel Wagner. A closed formula for the evaluation of foams. *Quantum Topol.*, 11(3):411–487, 2020. arXiv:1702.04140, doi:10.4171/qt/139.
- [RW20b] Louis-Hadrien Robert and Emmanuel Wagner. Symmetric Khovanov–Rozansky link homologies. *J. Éc. polytech. Math.*, 7:573–651, 2020. arXiv:1801.02244, doi:10.5802/jep.124.
- [Swe69] Moss E. Sweedler. *Hopf algebras*. Mathematics Lecture Note Series. W. A. Benjamin, Inc., New York, 1969.
- [Wan21] Joshua Wang. On $\mathfrak{sl}(N)$ homology with mod N coefficients, 2021. arXiv:2111.02287.
- [Wed19] Paul Wedrich. Exponential growth of colored HOMFLY-PT homology. *Adv. Math.*, 353:471–525, 2019. arXiv:1602.02769, doi:10.1016/j.aim.2019.06.023.
- [Wit89] Edward Witten. Quantum field theory and the Jones polynomial. *Comm. Math. Phys.*, 121(3):351–399, 1989. URL: <http://projecteuclid.org/euclid.cmp/1104178138>.
- [Wu14] Hao Wu. A colored $\mathfrak{sl}(N)$ homology for links in \mathbb{S}^3 . *Dissertationes Math.*, 499:217, 2014. arXiv:0907.0695, doi:10.4064/dm499-0-1.

(Y. Q.) DEPARTMENT OF MATHEMATICS, UNIVERSITY OF VIRGINIA, CHARLOTTESVILLE, VA 22904, USA

Email address: yq2dw@virginia.edu

(L.-H. R.) UNIVERSITÉ CLERMONT AUVERGNE, LMBP, CAMPUS DES CÉZEAUX, 3 PLACE VASARELY, TSA 60026, CS 60026, 63178 AUBIÈRE CEDEX, FRANCE

Email address: louis_hadrien.robert@uca.fr

(L.-H. R.) LABORATOIRE COGITAMUS, [HTTPS://WWW.COGITAMUS.FR/](https://www.cogitamus.fr/)

(J. S.) DEPARTMENT OF MATHEMATICS, CUNY MEDGAR EVERS, BROOKLYN, NY, 11225, USA

Email address: jsussan@mec.cuny.edu

(J.S.) MATHEMATICS PROGRAM, THE GRADUATE CENTER, NEW YORK, NY, 10016, USA

Email address: jsussan@gc.cuny.edu

(E. W.) UNIV PARIS CITÉ, IMJ-PRG, UNIV PARIS SORBONNE, UMR 7586 CNRS, F-75013, PARIS, FRANCE

Email address: emmanuel.wagner@imj-prg.fr

(E. W.) LABORATOIRE COGITAMUS, [HTTPS://WWW.COGITAMUS.FR/](https://www.cogitamus.fr/)