



**HAL**  
open science

# Analytical model to study the influence of sleeper width on the dynamic responses of a railway track

Le-Hung Tran, Tien Hoang, Gilles Foret, Denis Duhamel

## ► To cite this version:

Le-Hung Tran, Tien Hoang, Gilles Foret, Denis Duhamel. Analytical model to study the influence of sleeper width on the dynamic responses of a railway track. The fifth International Conference on Railway Technology, Railways 2022, Aug 2022, Montpellier, France. hal-03992731

**HAL Id: hal-03992731**

**<https://hal.science/hal-03992731>**

Submitted on 16 Feb 2023

**HAL** is a multi-disciplinary open access archive for the deposit and dissemination of scientific research documents, whether they are published or not. The documents may come from teaching and research institutions in France or abroad, or from public or private research centers.

L'archive ouverte pluridisciplinaire **HAL**, est destinée au dépôt et à la diffusion de documents scientifiques de niveau recherche, publiés ou non, émanant des établissements d'enseignement et de recherche français ou étrangers, des laboratoires publics ou privés.

**Important notes:**

**This document is only to assist with your short paper preparation.**

**You will need to copy and paste this information into the online submission form when you submit your short paper**

**Title:**

**ANALYTICAL MODEL TO STUDY THE INFLUENCE OF SLEEPER WIDTH ON THE DYNAMIC RESPONSES OF A RAILWAY TRACK**

**Authors & affiliations:**

L-H. TRAN <sup>a,b,\*</sup>, T. Hoang <sup>a</sup>, G. Foret <sup>a</sup>, D. Duhamel <sup>a</sup>

<sup>a</sup> *Laboratoire Navier, UMR 8205, Ecole des Ponts ParisTech, CNRS, UGE  
77420 Champs-sur-Marne, France*

<sup>b</sup> *Department of Engineering and Technology in Construction and Transportation Engineering - VNU  
Hanoi, University of Engineering and Technology, 144 Xuan Thuy Street, Cau Giay District, Hanoi,  
Vietnam*

**Short paper:**

The short paper should contain maximum of 1600 words. It should be prepared in 4 sections as below, with a maximum of 400 words each plus references.

**Introduction:** Clearly state the purpose of the work.

**Methods:** Describe your selection of observations or experimental subjects clearly.

**Results:** Present your results in a logical sequence in text, tables and illustrations.

**Conclusions & Contributions:** Emphasize new and important aspects of the study and conclusions that are drawn from them.

**References:** All references should be cited by using numbers into [.] and they should be numbered by the order they appear in the text

*Figures/photos/graphs are allowed but need to be numbered sequentially with 'Figure' captions and cited in the text*

*Tables are allowed but need to be numbered sequentially with 'Table' captions and cited in the text*



**Introduction:** Clearly state the purpose of the work – 400 words maximum

The dynamic response of a railway track has been studied by analytical and numerical methods. Since the 1970s, a railway track has been modelled by an infinite beam supported by an elastic foundation or periodical supports. By using a free wave propagation, Mead et al. [1] developed an analytic model for periodically supported infinite beams. Metrikine et al. [2] extended this model which includes the foundation behavior. Recently, Hoang et al. [3-4] have presented a characteristic relation between the reaction force and displacement of supports in a periodically supported beam. By using this relation, Tran et al. [5-6] have developed an analytical model for the dynamic of railway sleepers. Meanwhile, the numerical model has been also developed by several authors [7-9] to calculate the dynamic response of a railway track on transition zones. Combinations of analytic and numeric models (so-called semi-analytical models) have been used in several articles [10].

In this paper, a new analytical model is developed to study the influence of the support width to the dynamic response of a railway track. The rail is considered as a Euler-Bernoulli beam subjected to moving loads. The reaction force of the supports is written with the help of a rectangular function. The Fourier transform of the dynamic equation leads to a 4th order linear differential equation and then the solution can be expressed in a periodic form. The numerical results show that the model agrees well with the existing models when the support width is very small. Otherwise, the model shows the influence of the support with on the response of the railway track and the response of the rail.

**Methods:** Describe your selection of observations or experimental subjects clearly – 400 words maximum

Let's consider an infinite beam supported by periodical supports of width  $a$  shown in Figure 1. The length of one period is  $l$ . The beam is subjected to moving loads  $Q_j$  of speed  $v$ . The position of the moving load  $j$  is characterized by the distance  $D_j$  to the first load. Each support is modelled as a spring-damper system with stiffness  $k_s$  and damping coefficient  $\eta_s$ .

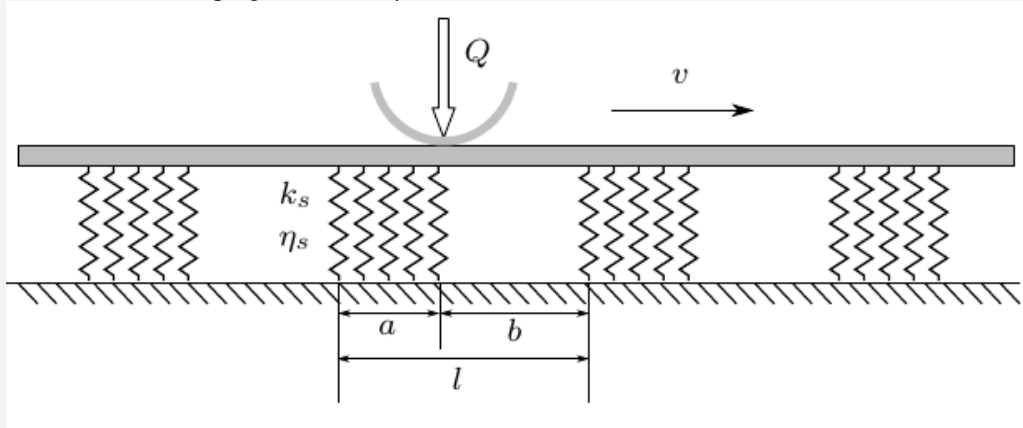

Figure 1. Analytical model presentation

The total force applied on the beam can be rewritten by using the Dirac distribution. The dynamic equation of the Euler-Bernoulli beam is the following:

$$EI \frac{\partial^4 w(x, t)}{\partial x^4} + \rho S \frac{\partial^2 w(x, t)}{\partial t^2} = \sum_{j=1}^K Q_j \delta(x + D_j - vt) - \sum_{n=-\infty}^{\infty} f_n(x, t) \Pi_a(x - nl)$$

where  $E$ ,  $I$ ,  $\rho$ ,  $S$  are respectively the Young modulus, moment of inertia, density and section area of the beam.  $\Pi_a(x)$  is the rectangular function which is equal to 1 if  $x$  in  $[0, a]$  and 0 otherwise. The function  $f_n(x, t)$  represents for the reaction force applied on the beam.

$$f_n(x, t) = k_s w(x, t) + \eta_s \frac{\partial w(x, t)}{\partial t} \quad nl \leq x \leq nl + a$$

By using the Fourier transform, the dynamic equation of the beam is written in the frequency domain as follows:

$$EI \frac{\partial^4 \hat{w}(x, \omega)}{\partial x^4} - \rho S \omega^2 \hat{w}(x, \omega) = \frac{1}{v} \sum_{j=1}^K Q_j e^{-i \frac{\omega}{v} (D_j + x)} - \sum_{n=-\infty}^{\infty} \hat{f}_0(x, \omega) e^{-i \frac{\omega}{v} nl} \Pi_a(x - nl)$$

If we put:

$$\hat{w}_r(x, \omega) = e^{-i \frac{\omega}{v} x} s(x, \omega)$$

the dynamic equation in the frequency domain of the rail becomes:

$$EI \left( s^{(4)} - 4i \frac{\omega}{v} s^{(3)} - 6 \frac{\omega^2}{v^2} s^{(2)} + 4i \frac{\omega^3}{v^3} s^{(1)} + \frac{\omega^4}{v^4} s \right) - \rho S \omega^2 s = \frac{1}{v} \sum_{j=1}^K Q_j e^{-i \frac{\omega}{v} D_j} - \sum_{n=-\infty}^{\infty} \hat{f}_0(x - nl, \omega) e^{i \frac{\omega}{v} (x - nl)} \Pi_a(x - nl)$$

where  $s^{(n)}$  stands for the  $n^{\text{th}}$  derivation of the function  $s$  with regard to  $x$ . We see that the right-hand side of the previous equation is periodic, and the left-hand side is linear, therefore, we find the solution in periodic form with the boundary conditions:

$$\begin{cases} s^{(n)}(0, \omega) = s^{(n)}(l, \omega) & \forall n = 0, 1, 2, 3 \\ s^{(n)}(a^+, \omega) = s^{(n)}(a^-, \omega) & \forall n = 0, 1, 2, 3 \end{cases}$$

The boundary conditions are the continuity of the displacement, slope, moment, and shear force of the beam in one period  $[0, l]$ .

In the interval  $[0, a]$ , the solution is:

$$s(x, \omega) = \sum_{k=1}^4 A_k e^{\alpha_k x} - \frac{\sum_{j=1}^K Q_j e^{-i\frac{\omega}{v} D_j}}{vEI \left( \frac{\omega^4}{v^4} - \lambda_a^4 \right)}$$

$$\lambda_a = \sqrt[4]{\frac{\rho S \omega^2 - K_s}{EI}} \quad \text{and} \quad K_s = k_s + i\omega \eta_s$$

where

and

In the interval  $x=[a, l]$ , the solution is:

$$s(x, \omega) = \sum_{k=1}^4 B_k e^{\beta_k x} - \frac{\sum_{j=1}^K Q_j e^{-i\frac{\omega}{v} D_j}}{vEI \left( \frac{\omega^4}{v^4} - \lambda_b^4 \right)}$$

$$\lambda_b = \sqrt[4]{\frac{\rho S \omega^2}{EI}}$$

where

The constants  $A_k$  and  $B_k$  ( $k = [1, 2, 3, 4]$ ) in the two last equations can be determined numerically or analytically by applying the boundary conditions into the dynamic equation of the beam in the frequency domain.

**Results:** Present your results in a logical sequence in text, tables and illustrations – 400 words maximum

### 3.1 Validation of model

We compare the results obtained by this model while  $a \ll l$  (the reaction force can be described by a point force) and the periodically supported beam model [4]. The track parameters are given in the Table. 1. The beam is subjected to 2 moving loads which corresponds to the passing of 1 axle. Each wheel load is  $100 \text{ kN}$  and the speed is  $90 \text{ kmh}^{-1}$ .

Parameters	Notation	Value	Unity
Section mass of rail	$\rho S$	60	$\text{kgm}^{-1}$
Section stiffness of rail	$EI$	6.3	$\text{MNm}^2$
Length of one period	$l$	0.6	m
Sleeper width	$a$	0.25	m
Stiffness of support	$k_s$	192	$\text{MNm}^{-1}$
Damping of support	$n_s$	1.97	$\text{MNsm}^{-1}$

Table 1. Track parameters

Figure. 2 shows the displacement and the reaction force applied on the rail. The blue lines present the responses calculated by this model while  $a \ll l$  and the red ones are obtained by the existing model (see [4]). We see that the two models agree well.

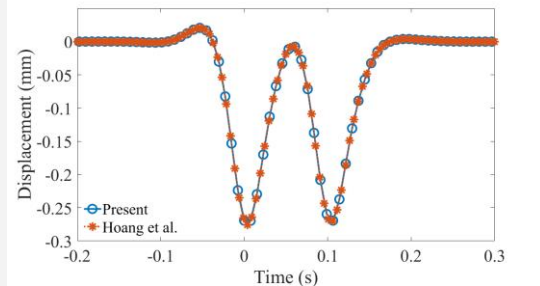

Fig. 2a. Displacement

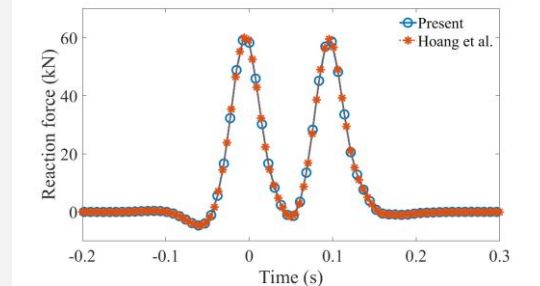

Fig. 2b. Reaction force

Figure 2. Comparison of the new model and the periodically supported beam model

### 3.2 Numerical example

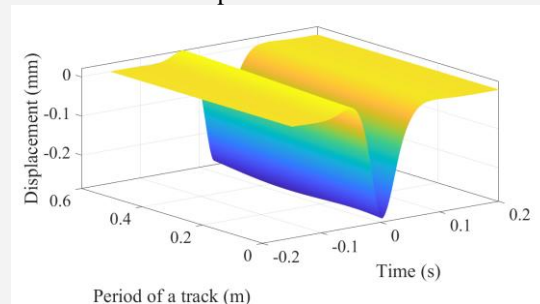

Fig 3a. Displacement

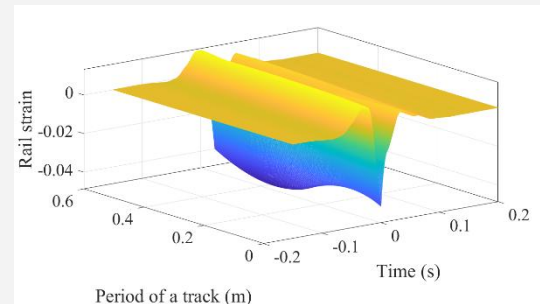

Fig 3b. Rail strain

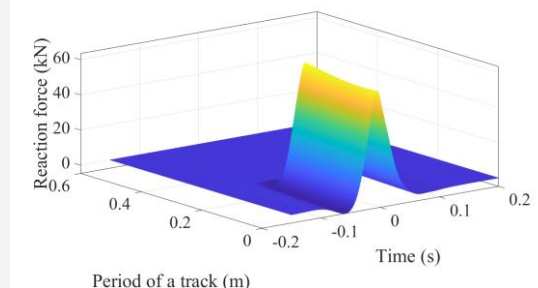

Fig 3c. Reaction force

Figure 3. Track responses

A numerical example is calculated with the sleeper width  $a = 0.264 \text{ m}$ , which corresponds to the mono block sleeper used. The period of the track is  $L = 0.6 \text{ m}$ . The other parameters are given in Table 1.



Figs. 3a, 3b and 3c show the displacement, the strain and reaction force of the rail (the strain is calculated at  $z = 0.035$  m - under the rail head. We see that the reaction force is only at the supported interval  $[0, a]$ . In addition, the strain and the displacement of the rail in this interval is less than the unsupported interval.

### 3.3 Influence of the sleeper width on the beam responses

Now we study the influence of the support width on the beam responses. The track parameters are those given in Table 1. Figure 4 shows the track responses with different sleeper widths. We see that when the beam is continuously supported ( $a = 0.6$ ), the rail response is homogenous. When the support is a point force ( $a = 0$ ), the variation of response is larger between the supported point and non-supported position on the rail. This result is interesting: when we need a “smooth” track, the rail with a large support has more advantage.

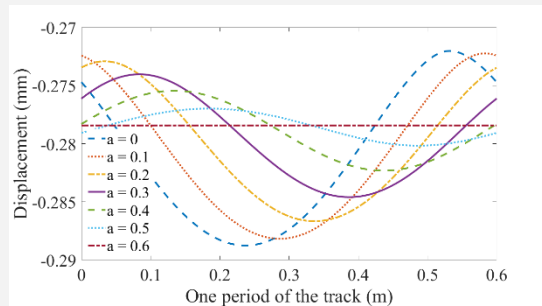

Fig 4a. Rail displacement

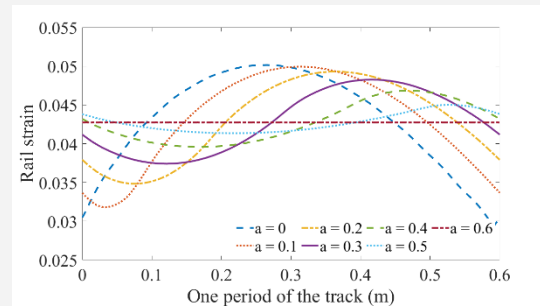

Fig 4b. Rail strain



**Conclusions & Contributions:** Emphasize new and important aspects of the study and conclusions that are drawn from them – 400 words maximum

This paper presents an analytic model for the dynamic responses of the railway track to study the effect of the support width. This model agrees well with existing models with the continuous support or concentrated point supports. Otherwise, it permits to calculate fast the track responses when the support width is not small. The application shows that the support width does not influence the force distribution, but the rail responses have **an important variation** between the supported and non-supported interval.



References: All references should be cited by using numbers into [.] and they should be numbered by the order they appear in the text

- [1] D. Mead, Wave propagation in continuous periodic structures: Research contributions from Southampton, 1964-1995, Journal of Sound and **Vibration**, 193 (3) (1996)
- [2] Vostroukhov A. and Metrikine **A.**, Periodically supported beam on a visco-elastic layer as a model for dynamic analysis of a high-speed railway track, International Journal of Solid and Structure, 40 (21) (2003)
- [3] T. Hoang et al., Calculation of force distribution for a periodically supported beam subjected to moving loads, Journal of Sound and **Vibration**, 388 (2017)
- [4] T. Hoang et al., Dynamical response of a Timoshenko beams on periodical nonlinear supports subjected to moving forces, Engineering **Structures**, 176 (2018)
- [5] L-H., Tran et al., A fast analytic method to calculate the dynamic response of railways sleepers, Journal of Vibration and Acoustic, 141 (1) (2019)
- [6] L-H., Tran et al., A comparison of beam models for the dynamics of railway sleepers, International Journal of Rail Transportation, 10 (2) (2022)
- [7] Z. Dimitrova et al, Critical velocity of a load moving on a beam with a sudden change of foundation stiffness: Application to high-speed trains, Computer & **Structures**, 87 (19) (2009)
- [8] J. N. Varandas et al, Dynamic behavior of railway tracks on transitions zones, Computer & **Structures**, 89 (13) (2011)
- [9] Paixao et al., Numerical simulation to improve the use of under sleeper pads at transition zones to railway bridges, Engineering **Structures**, 164 (2018) 169-182
- [10] L.-H. Tran et al, Influence of non-homogeneous foundation on the dynamic responses of railway sleepers, International Journal of Structural Stability and Dynamics **volume ??** (2020)