

Coherently coupled molecules at cryogenic temperatures : from super- /sub- radiance to optical selection rules

Jean-Baptiste Trebbia

Laboratoire Photonique, Numérique et Nanosciences - LP2N
Université Bordeaux - IOGS - CNRS : UMR 5298

Motivations

Controlled, coherent manipulation of delocalized quantum systems

- An important challenge in modern science
- Significant applications in quantum technologies

Scalable solid-state quantum devices

networks of strongly interacting qubits

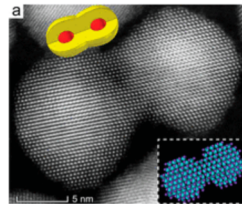
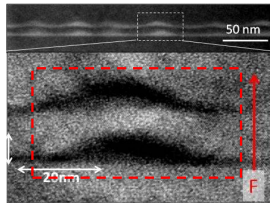

Rydberg Atoms

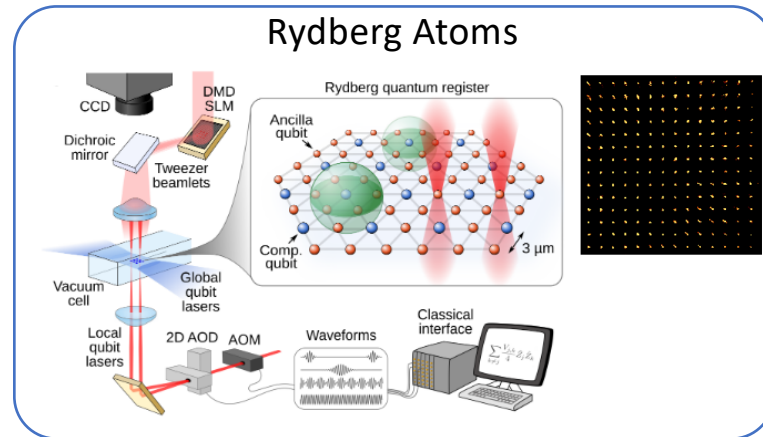

Collective quantum states:
at the heart of many
important phenomena

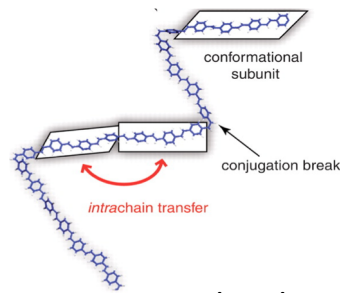

Conjugated polymers

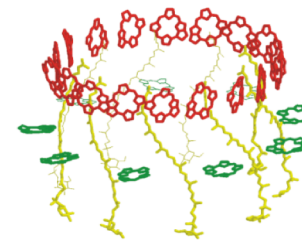

Light harvesting complex

Single molecule at low temperature (2K)

Possible molecules (PAH) and host systems :

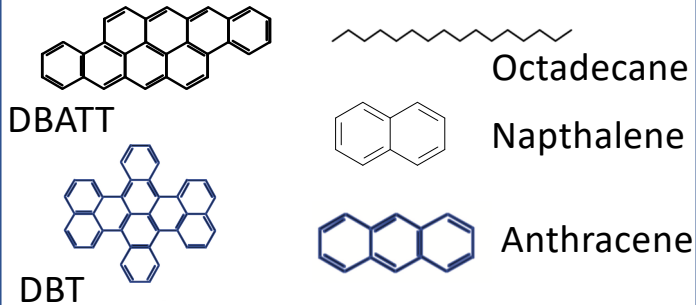

Why Molecules are interesting?

- ✓ Photostability
- ✓ Behaves like a two level system
- ✓ Resonances with high quality factors (up to $\sim 10^8$)
- ✓ Narrow Zero Phonon Line
- ✓ Single photon source
- ✓ Indistinguishable photons

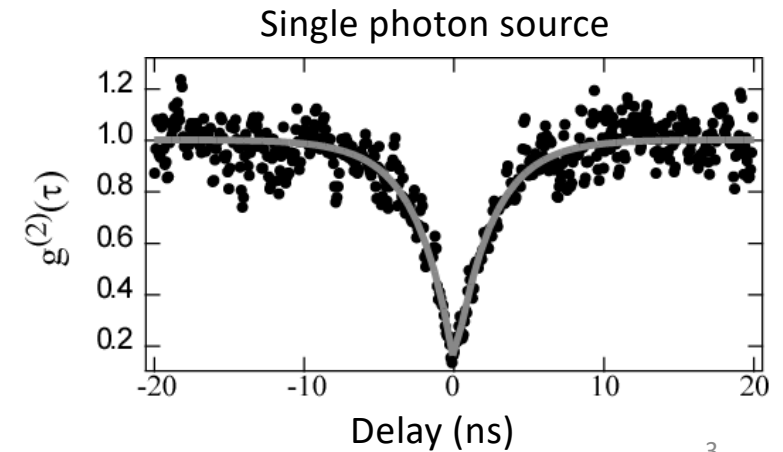
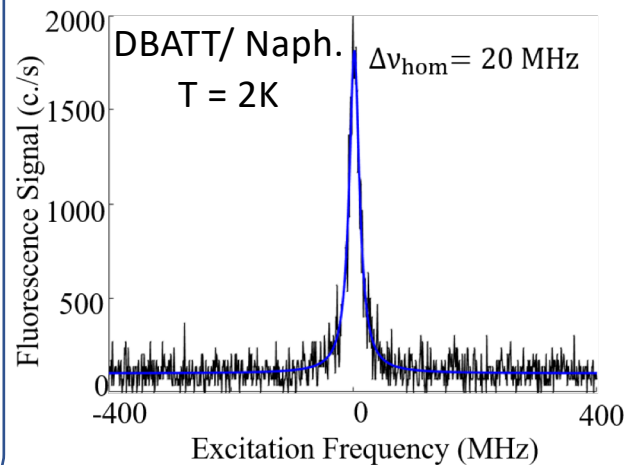
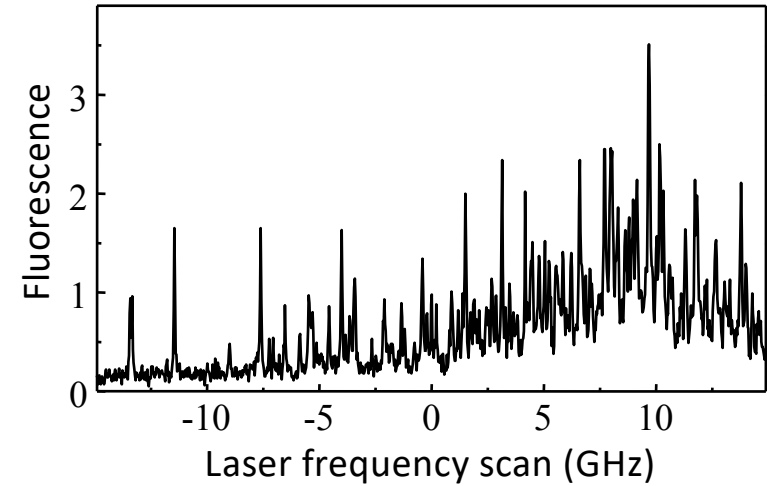
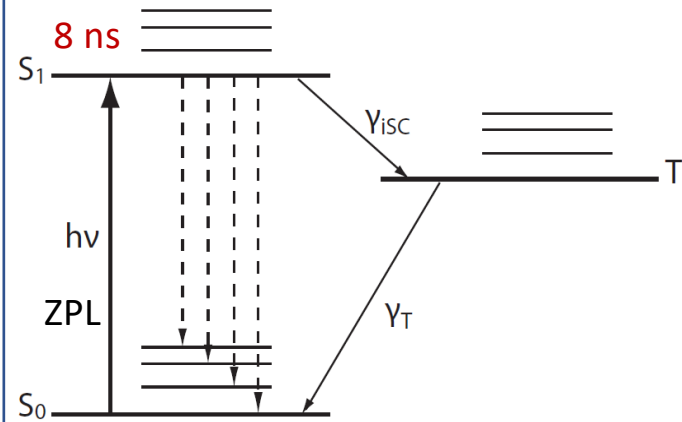

Ultra fast Rabi oscillations :

Experimental Setup :

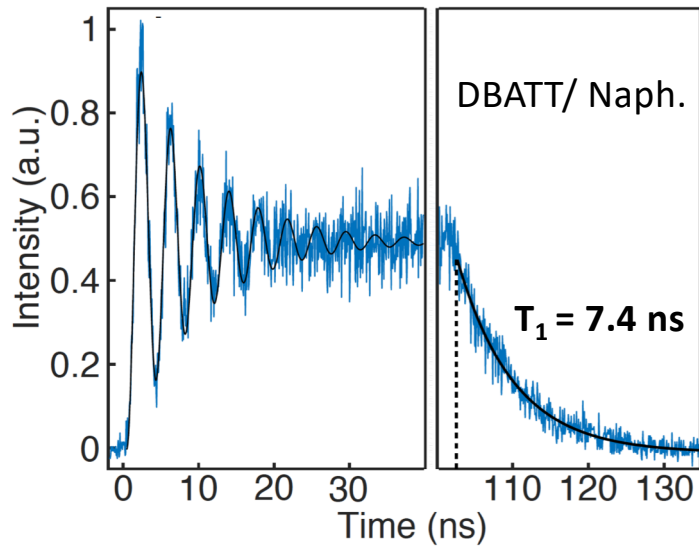
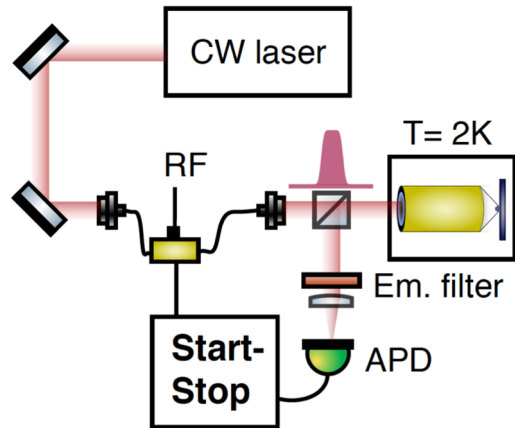

Decay measurements give : T_1 and T_2 times

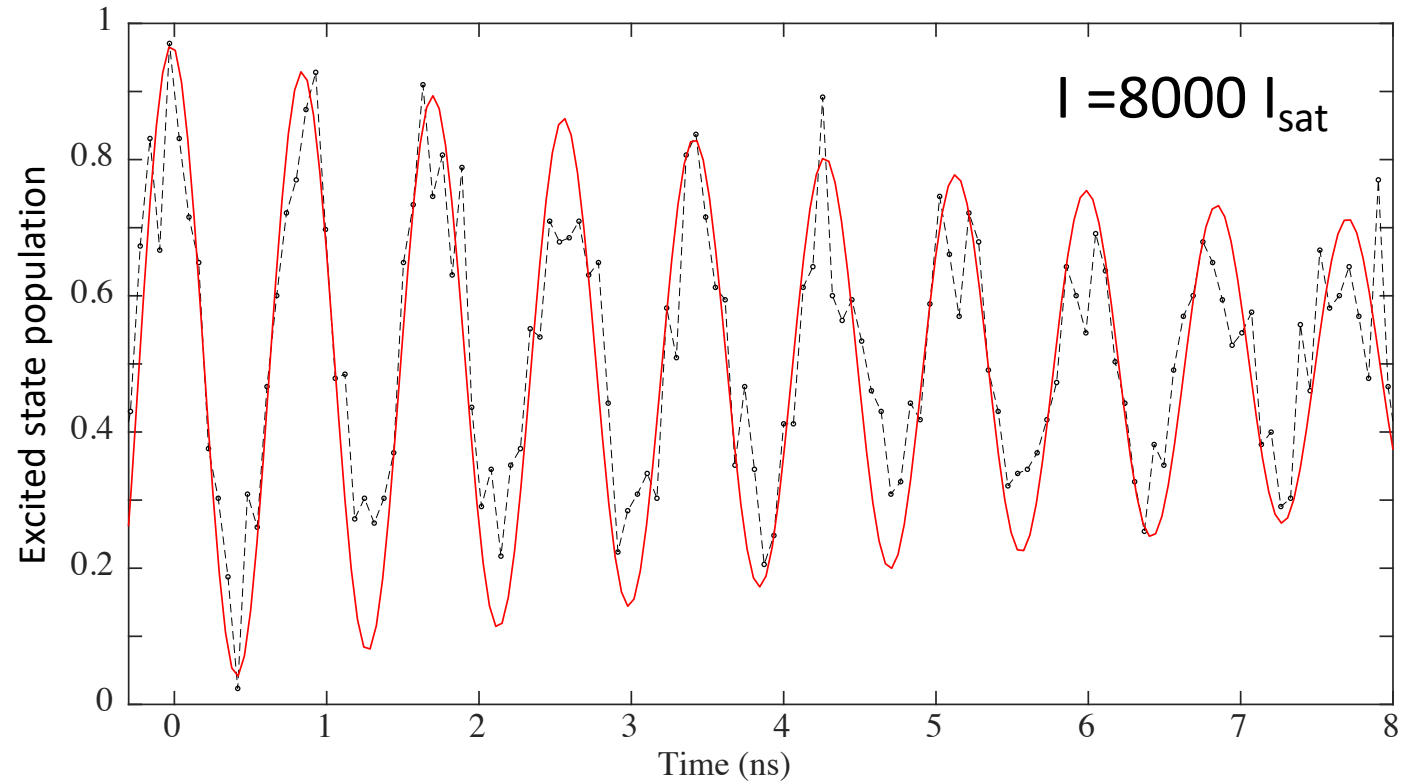

Sub nanosecond Rabi oscillations :

- Period : **850 ps**
- No additional decoherence (**limited by $2T_1$**)
- Excited state preparation fidelity : **$(96 \pm 3) \%$**

T₂ determination with Ramsey measurement

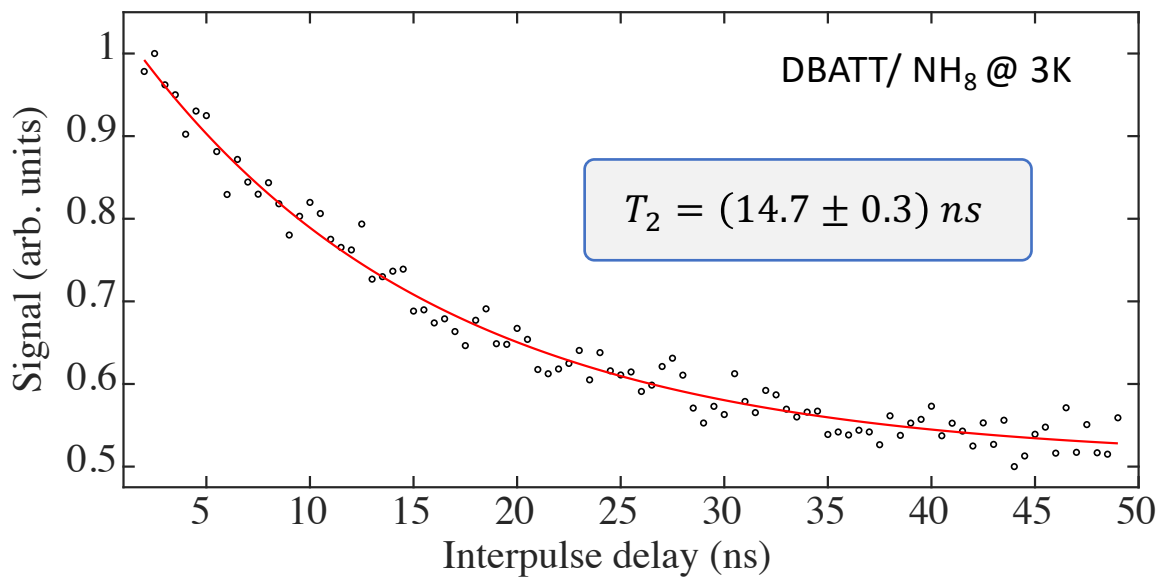
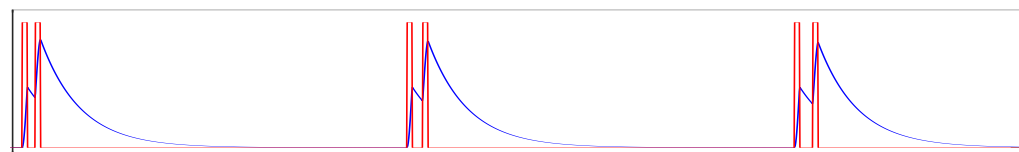
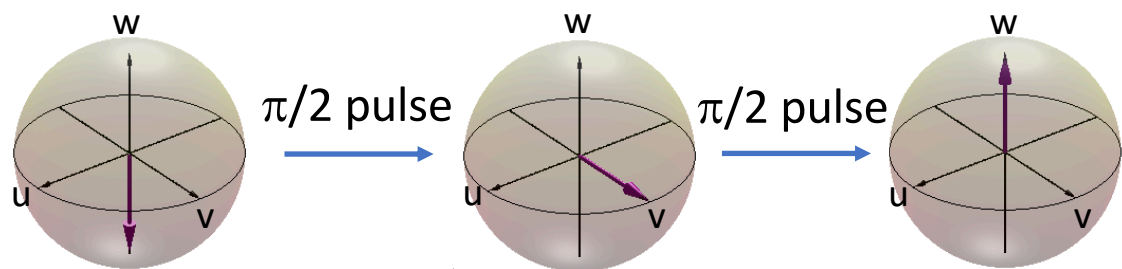

Deplano *et al.* In preparation
(2023)

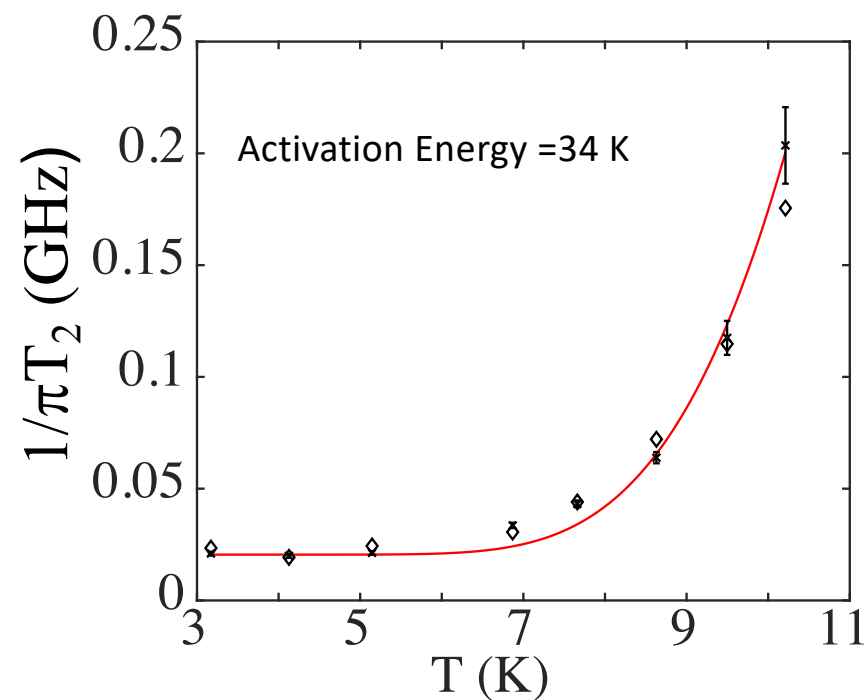

Follows the Arrhenius law : $\gamma(T) = \gamma(0)e^{\frac{E_a}{RT}}$
In agreement with the homogeneous FWHM evolution

Tunability with Stark Effect

Molecular transition frequency shifts
with electric fields :

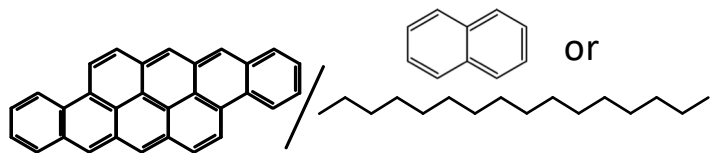

$$\hbar\omega(E) - \hbar\omega_0 = -\Delta\mu E - \frac{1}{2}\Delta\alpha E^2$$

Linear Stark Shift

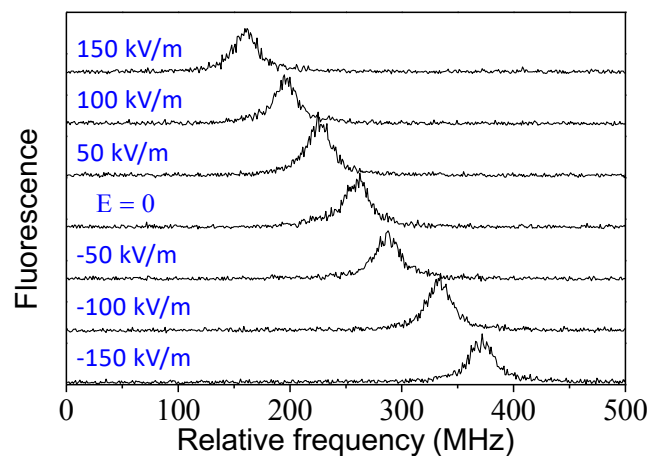

Permanent dipole moment:
 $\Delta\mu \sim 0.3 \text{ D}$, ($\sim 1 \text{ GHz/MV/m}$)

Quadratic Stark Shift

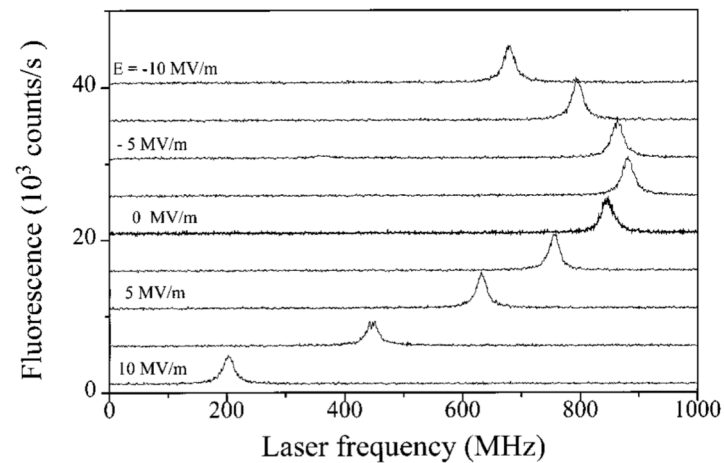

J. Phys. Chem. A 103, 2429-2434 (1999)

Two photon interferences (ZPL)

Hong Ou Mandel Experiment :

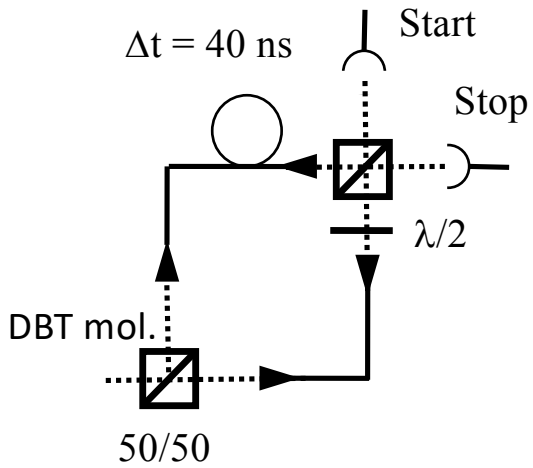

Distinguishable events :

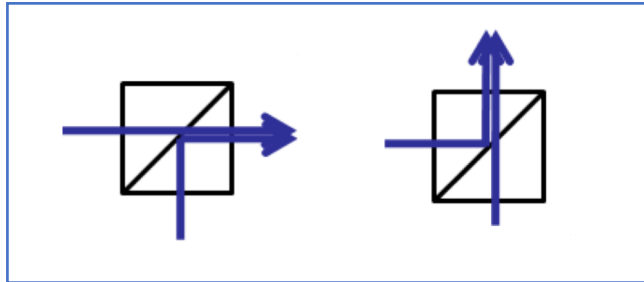

Indistinguishable events :

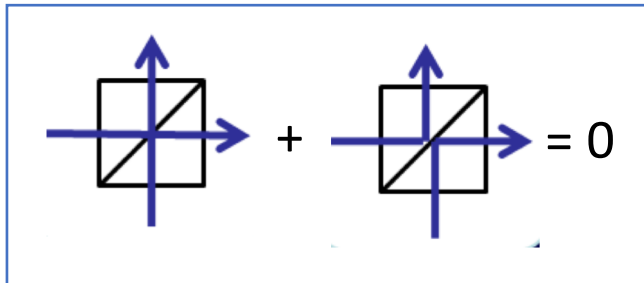

Coalescence efficiency

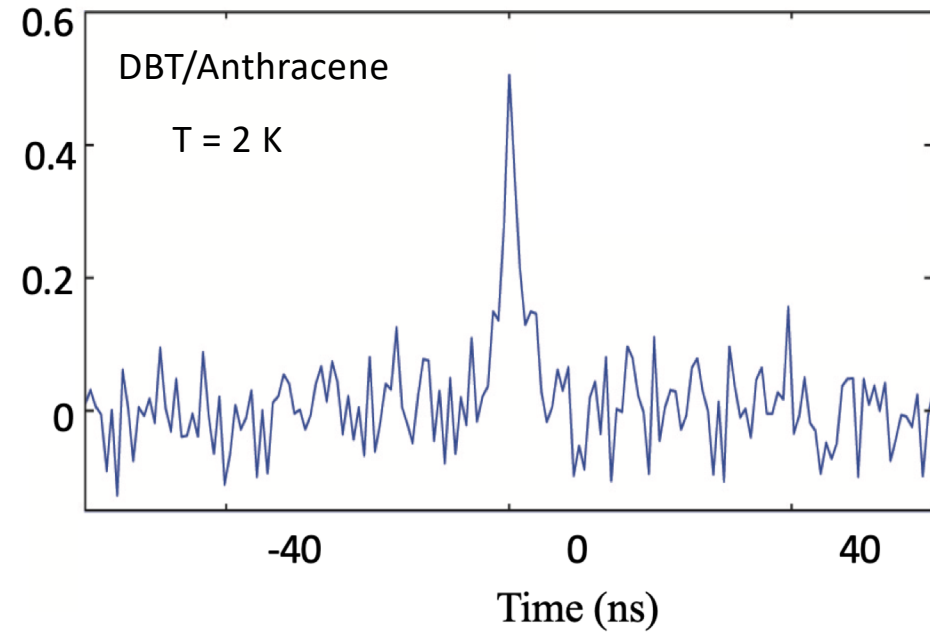

Scalability?

First experimental demonstration of the **Coherent Optical Dipole Coupling of Two Individual Molecules**

Hettich, C. et al. *Science*
298, 385 (2002)

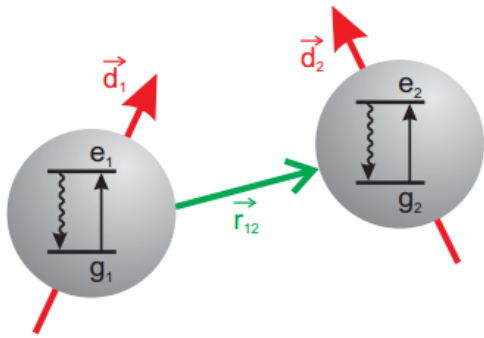

$$\text{Dipole interaction} \propto \frac{1}{(r_{12})^3}$$

12 nm !!

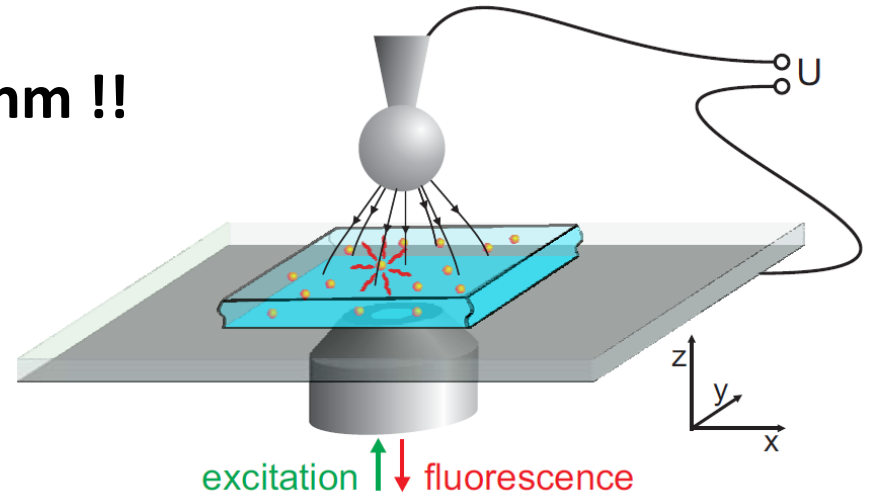

Need for an optical method to image the interacting emitters

Finding close emitters at 2K :

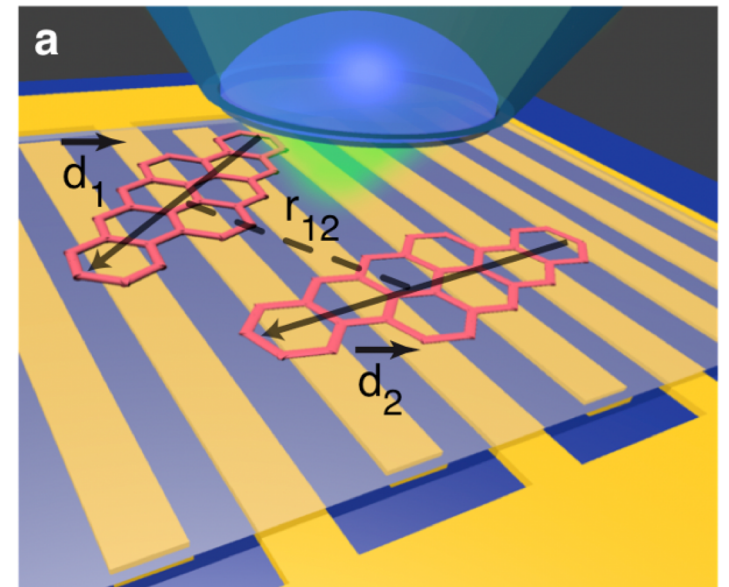
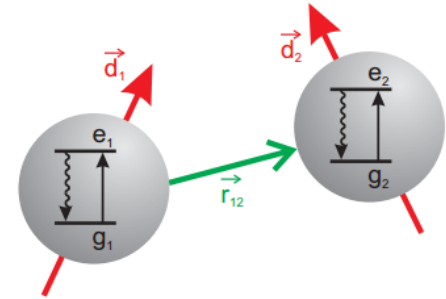
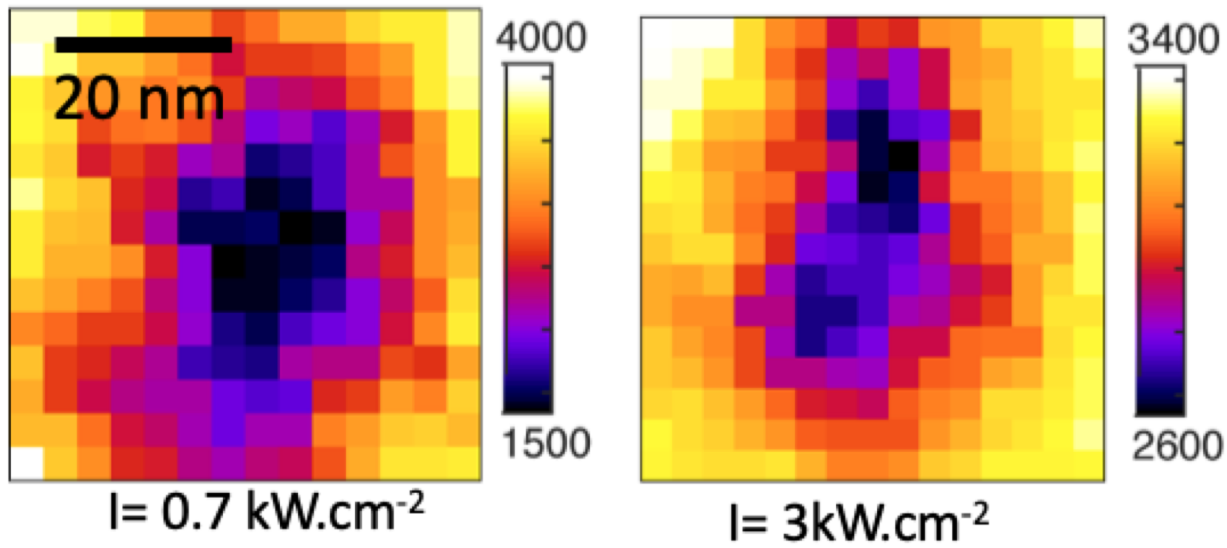

Molecular entanglement ?

Coherent Optical Dipole Coupling of Two Individual Molecules

Coupling constant :

$$V = \frac{3\hbar\gamma_0}{4(kd)^3} [(\hat{\mu}_1 \cdot \hat{\mu}_2) - 3(\hat{\mu}_1 \cdot \hat{e}_{12})(\hat{\mu}_2 \cdot \hat{e}_{12})]$$

Cross-damping rate :

$$\gamma_{12} = \gamma_0 (\hat{\mu}_1 \cdot \hat{\mu}_2)$$

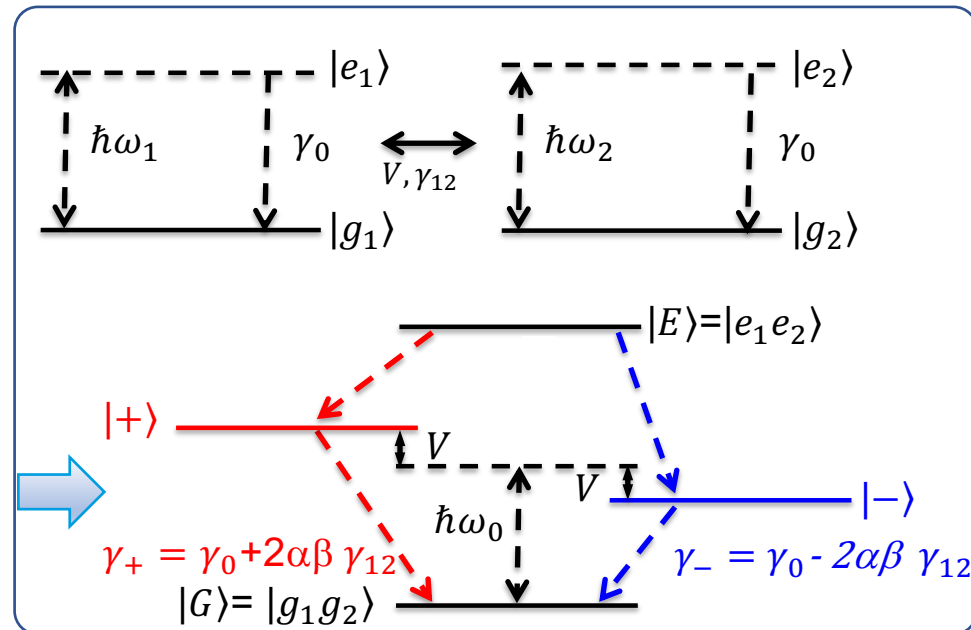
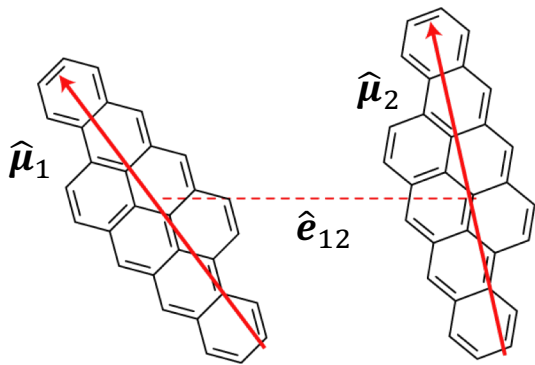

2 entangled « delocalized » states

$$\begin{cases} |+\rangle = (\alpha|e_1, g_2\rangle + \beta|g_1, e_2\rangle) \\ |-\rangle = (\beta|e_1, g_2\rangle - \alpha|g_1, e_2\rangle) \end{cases}$$

Hettich et al. Science (2002)

Signatures of the coherent dipole dipole interaction

Excitation spectrum calculated using Master Equation :

$$\dot{\rho} = -\frac{i}{\hbar} [H, \rho] - \frac{1}{2} \sum_{i,j} \gamma_{ij} (S_i^+ S_j^- \rho + \rho S_i^+ S_j^- - 2S_j^- \rho S_i^+)$$

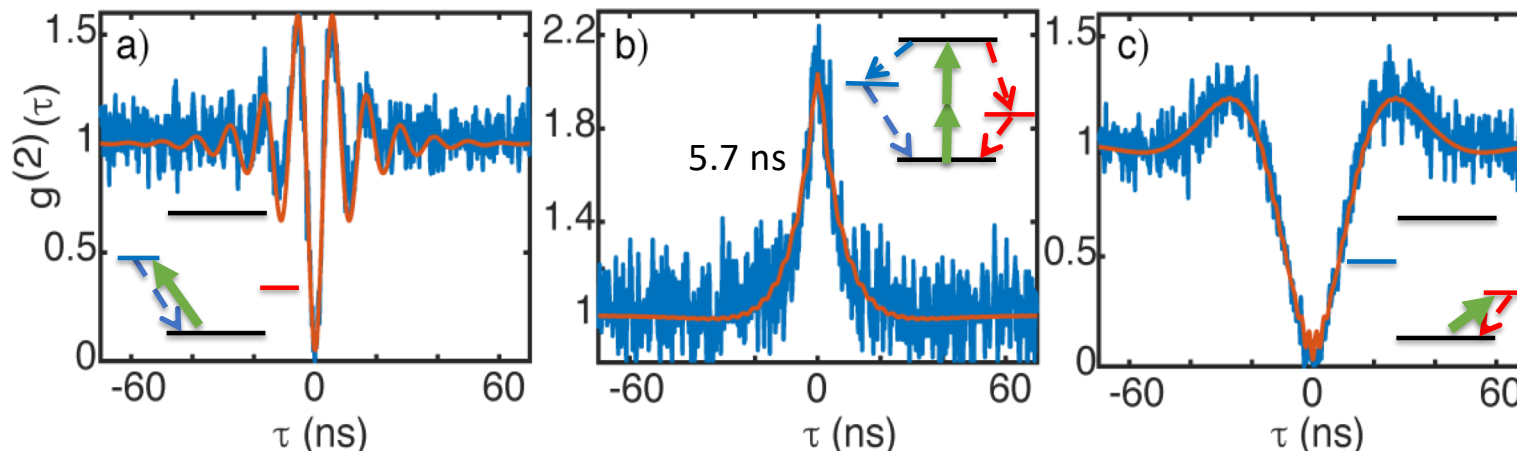
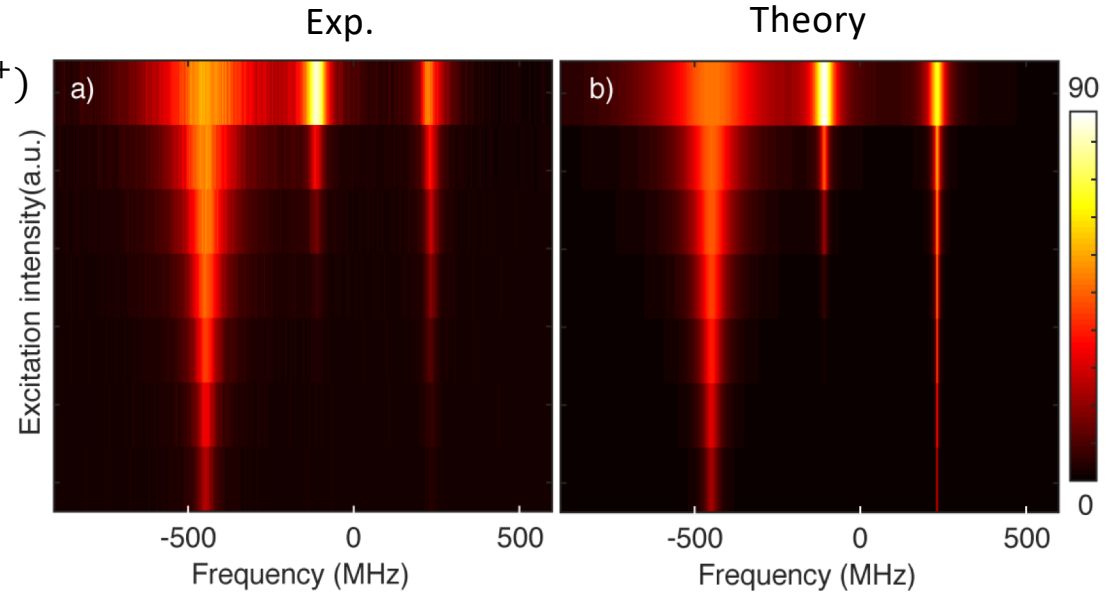
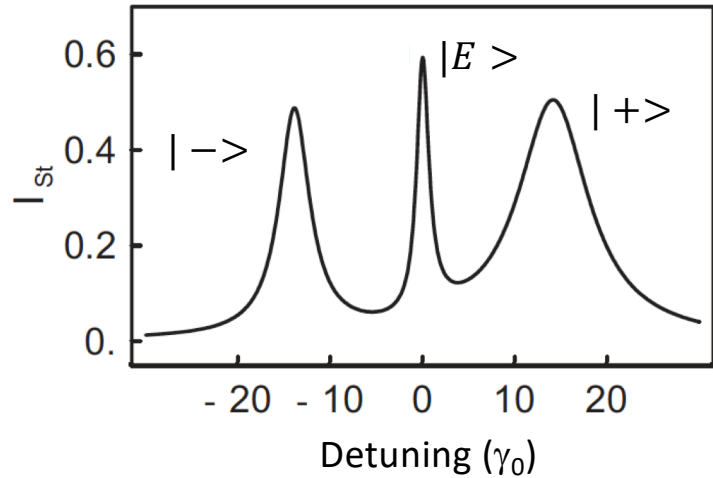

Gallery of coupled molecules

Optical nanoscopy allows finding coherently coupled molecules with different degree of entanglement

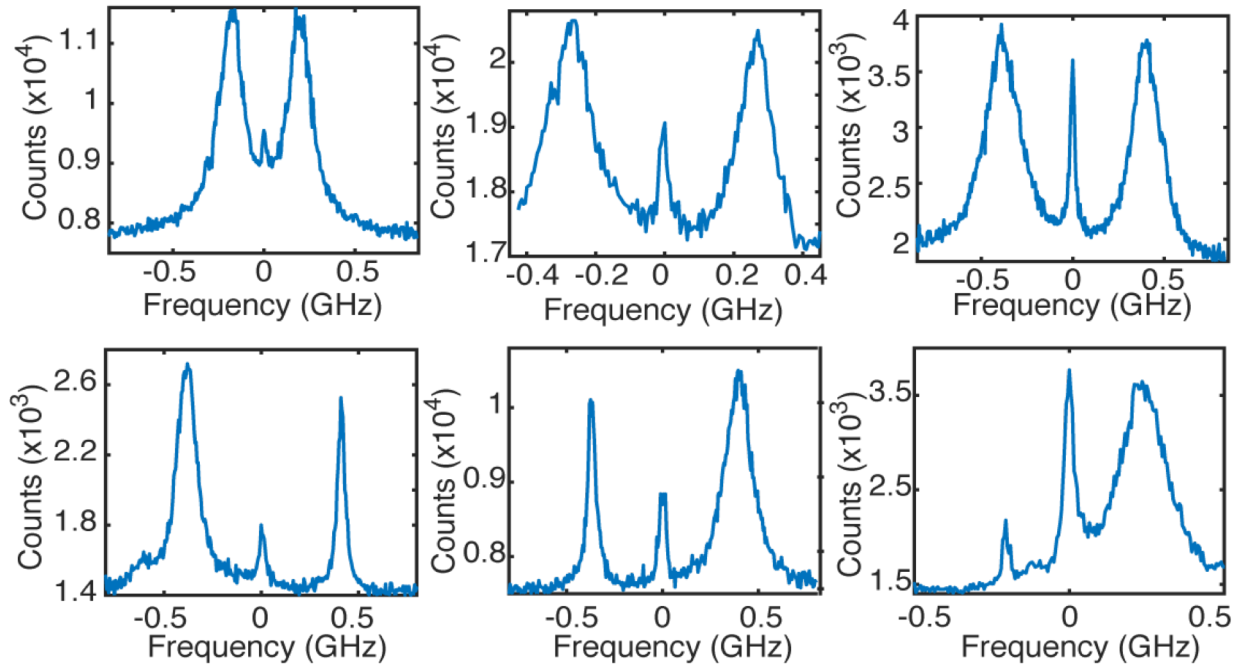

J Configuration

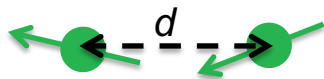

Nat Commun **13**, 2962 (2022)

H Configuration

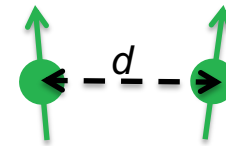

Manipulating the molecular Entanglement

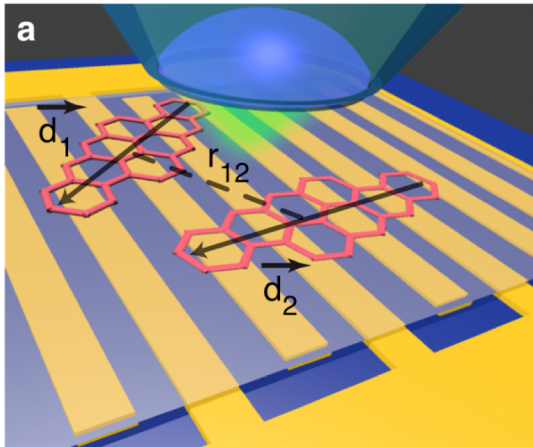

H Configuration

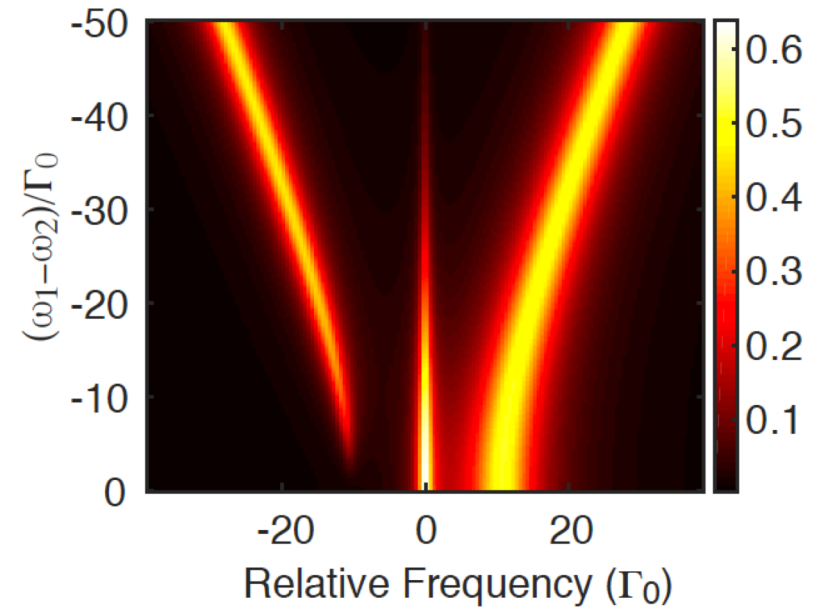
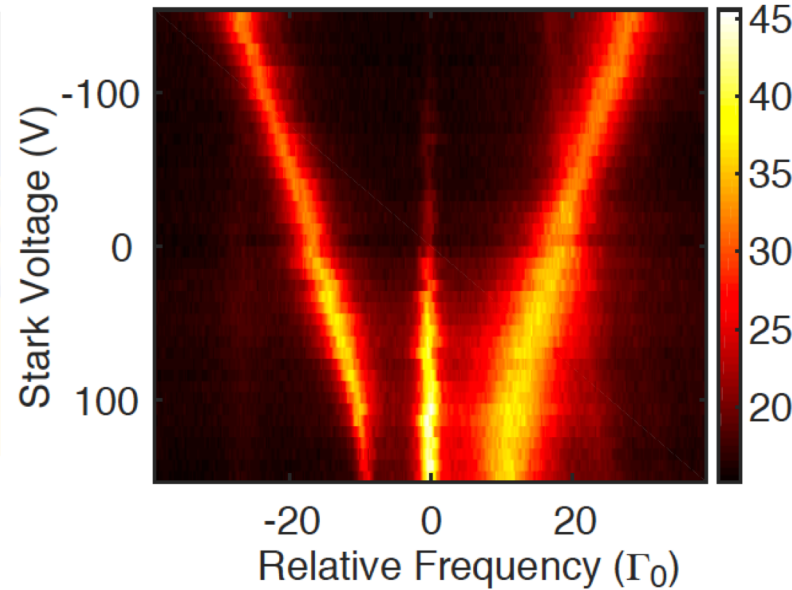
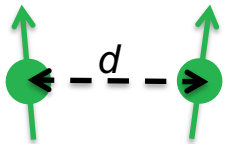

Maximum entanglement when $\Delta \rightarrow 0$:
 $\alpha, \beta \rightarrow \frac{1}{\sqrt{2}}$, and $\gamma_+ \rightarrow 2\gamma_0, \gamma_- \rightarrow 0$
 From $V/h \sim 10\gamma_0$, estimated distance:
 $d \sim 25\text{nm}$

$|+\rangle$ and $|-\rangle$ are close to
 Bell States :

$$|+\rangle = \frac{1}{\sqrt{2}} (1.13|eg\rangle - 0.84|ge\rangle)$$

$$|-\rangle = \frac{1}{\sqrt{2}} (0.84|eg\rangle - 1.13|ge\rangle)$$

Aromatic molecules in Molecular Crystals

Emission Spectrum

- Narrow Zero Phonon Lines: purely radiative transition
- Red-shifted vibrational lines and phonon sidebands

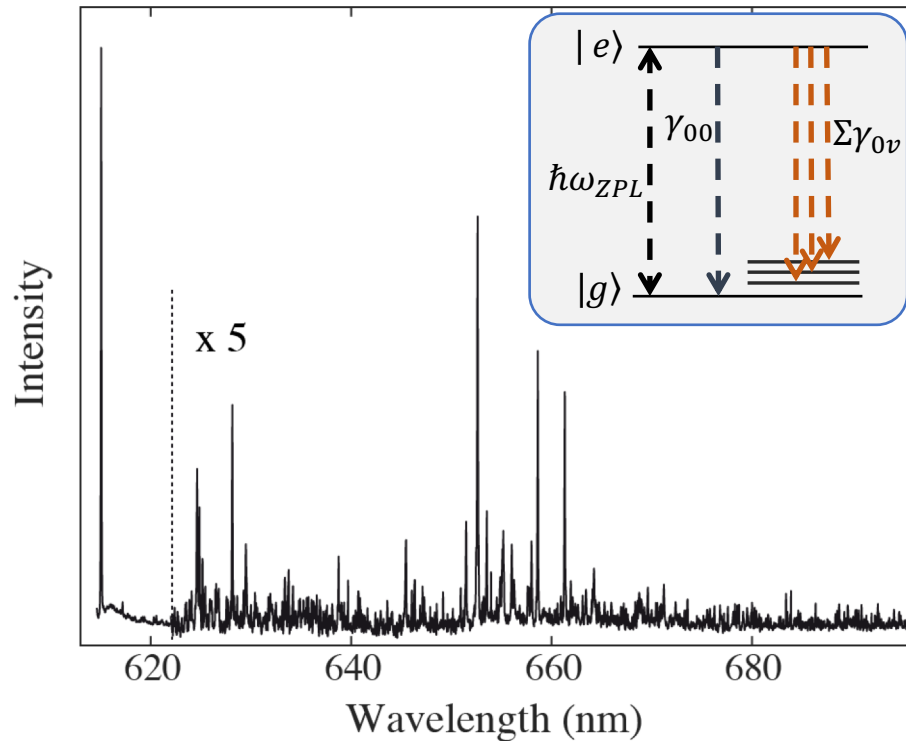

Excited state lifetime γ_0^{-1}
 $\gamma_0 = \gamma_{00} + \Sigma\gamma_{0v}$
 with $\gamma_{00} = \eta_{ZPL}\gamma_0$

Combined Debye-Waller /
 Franck-Condon factor

$$\eta_{ZPL} = \frac{\gamma_{00}}{\gamma_{00} + \Sigma\gamma_{0v}}$$

Low Temperature single molecule Emission Spectrum $\rightarrow \eta_{ZPL} \sim 0.35$

sub/super-radiance for two coherently coupled molecules :

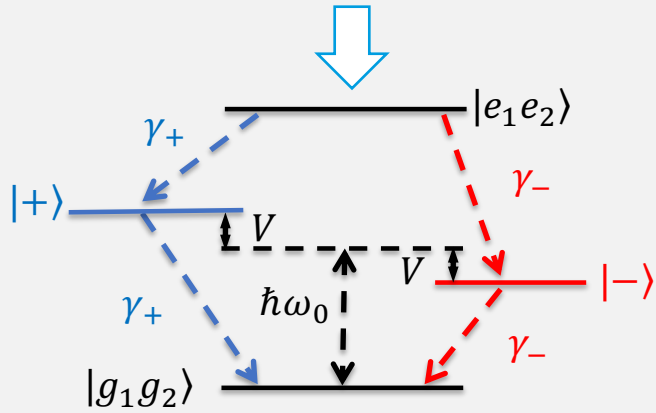
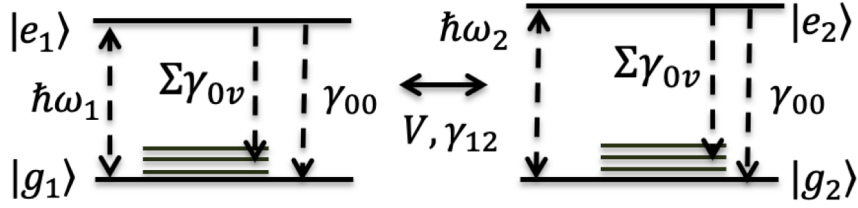

For $\omega_2 = \omega_1$ and $\mu_1 // \mu_2$:
 $\gamma_+ \rightarrow \gamma_0(1 + \eta_{ZPL})$
 $\gamma_- \rightarrow \gamma_0(1 - \eta_{ZPL})$

Coherent dipole-dipole coupling

$$V = \frac{3\eta_{ZPL}\gamma_0}{4(kd)^3} [(\hat{\mu}_1 \cdot \hat{\mu}_2) - 3(\hat{\mu}_1 \cdot \hat{e}_{12})(\hat{\mu}_2 \cdot \hat{e}_{12})]$$

Incoherent cross-damping rate

$$\gamma_{12} = \eta_{ZPL}\gamma_0(\hat{\mu}_1 \cdot \hat{\mu}_2)$$

Nat Commun 13, 2962 (2022)

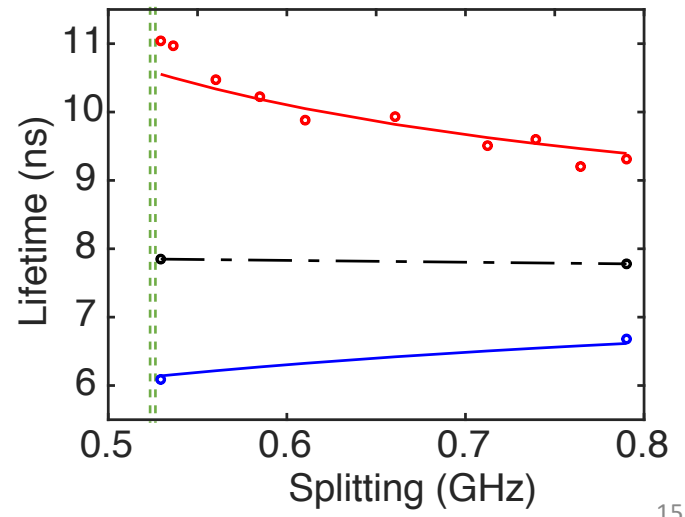
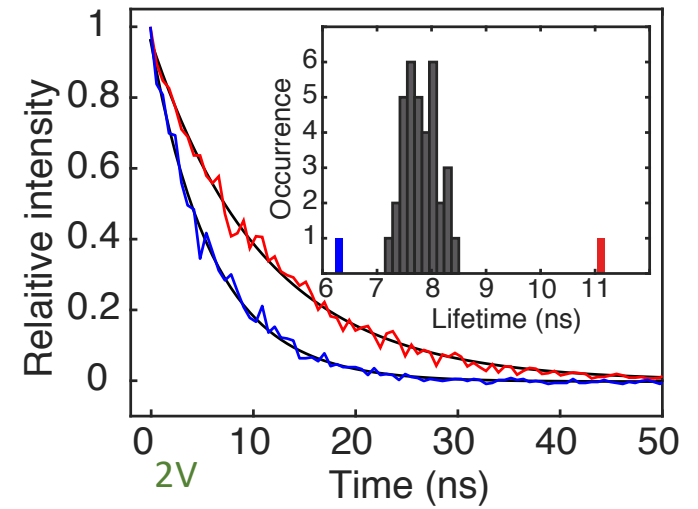

Delocalized states coupling to laser fields

Hamiltonian governing the coupled with a driving laser of frequency ω_L

$$H = \hbar\omega_0(|E\rangle\langle E| - |G\rangle\langle G|) + \hbar\Lambda(|+\rangle\langle +| - |-\rangle\langle -|) - \frac{\hbar}{2} \left\{ [(\alpha\Omega_1 + \beta\Omega_2)|E\rangle\langle +| + (\beta\Omega_1 + \alpha\Omega_2)|+\rangle\langle G|] e^{i\omega_L t} + [(\alpha\Omega_2 - \beta\Omega_1)|E\rangle\langle -| - (\beta\Omega_2 - \alpha\Omega_1)|-\rangle\langle G|] e^{i\omega_L t} + h.c. \right\}$$

Complex Rabi frequencies: $\Omega_i = -\vec{\mu}_i \cdot \vec{\mathcal{E}}(\vec{r}_i - \vec{r}_c) / \hbar$

Matrix elements that govern the laser coupling strengths:

$$\left. \begin{array}{l} \langle -|H|G\rangle \propto \alpha\Omega_1 - \beta\Omega_2 \\ \langle +|H|G\rangle \propto \beta\Omega_1 + \alpha\Omega_2 \end{array} \right\} \rightarrow \text{depend on } \alpha, \beta \text{ and } \Omega_i$$

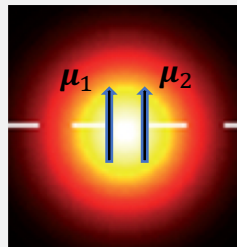
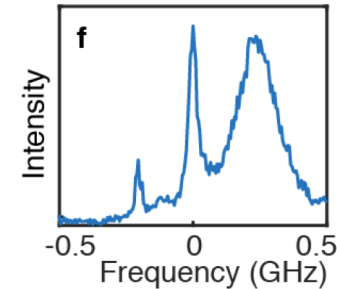

Gaussian laser spot centered between the molecules:

- Generation of in-phase dipole oscillations with $\Omega_1 = \Omega_2$.

When Δ approaches zero ($\alpha \approx \beta \approx 1/\sqrt{2}$):

- Excitation of the superradiant state is enhanced (by up to $\sqrt{2}$), while that of the subradiant state becomes forbidden.

Enhanced laser coupling to the subradiant state

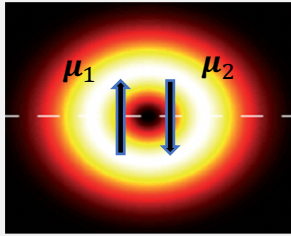

Doughnut-shaped laser spot centered between the molecules:

- Opposite-phase dipoles oscillations, $\Omega_1 = -\Omega_2$.

When Δ approaches zero ($\alpha \approx \beta \approx 1/\sqrt{2}$):

- Excitation of the subradiant state is enhanced, while that of the superradiant state is forbidden.

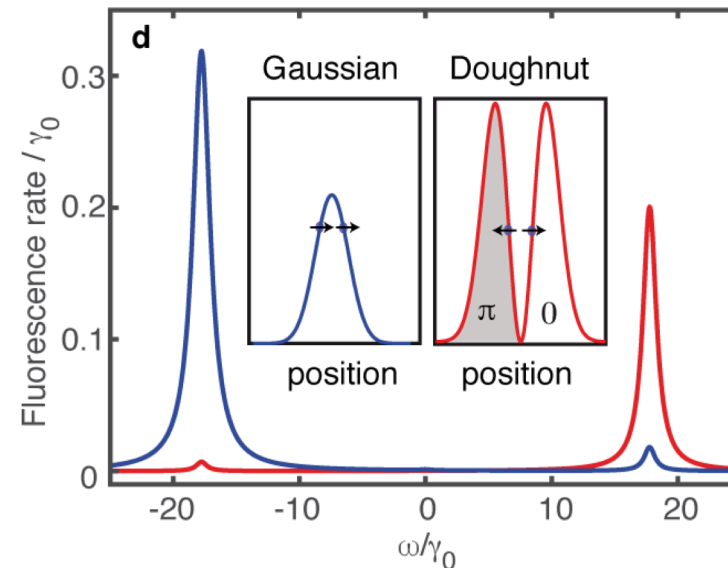
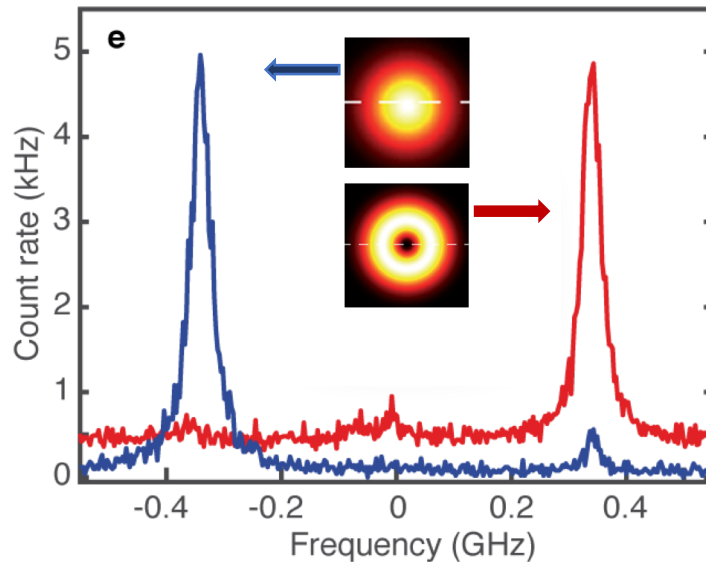
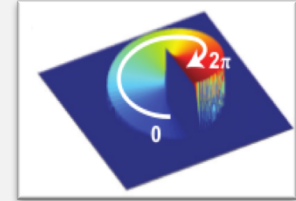

A method for selective preparation of long-lived subradiant states

Nat Commun **13**, 2962 (2022)

Conclusions and Perspectives

Conclusions:

Ultra stable quantum system : excitation during weeks without any photobleaching,

Optical nanoscopy to find and super-resolve coupled pairs in various configurations,

Possibility to entangle and disentangle two molecules with an electric field.

Perspectives:

Quantum logic gates



Phys. Rev. Lett. 104, 010503 (2010)

Decoherence effects with the temperature

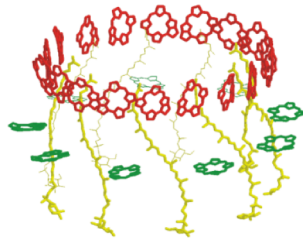

Nature, 2007, 446, 782-786 (2007)

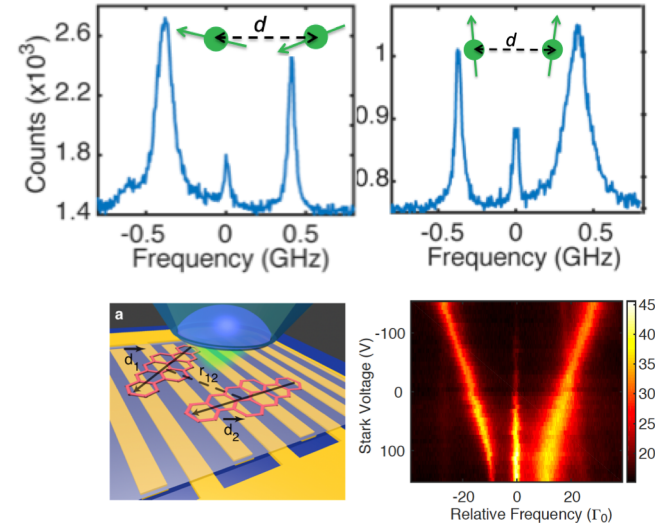

Resonant fluorescent excitation spectra

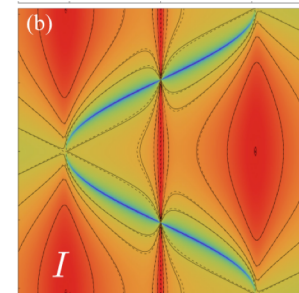

Phys. Rev. Research 3, 033136 (2021)

Acknowledgements

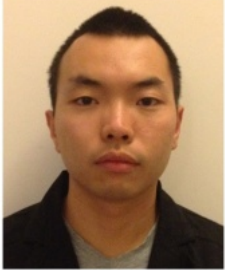

Bin
Yang



Reenu
Baby



Quentin
Deplano



Philippe
Tamarat



Brahim
Lounis

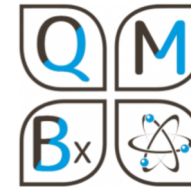
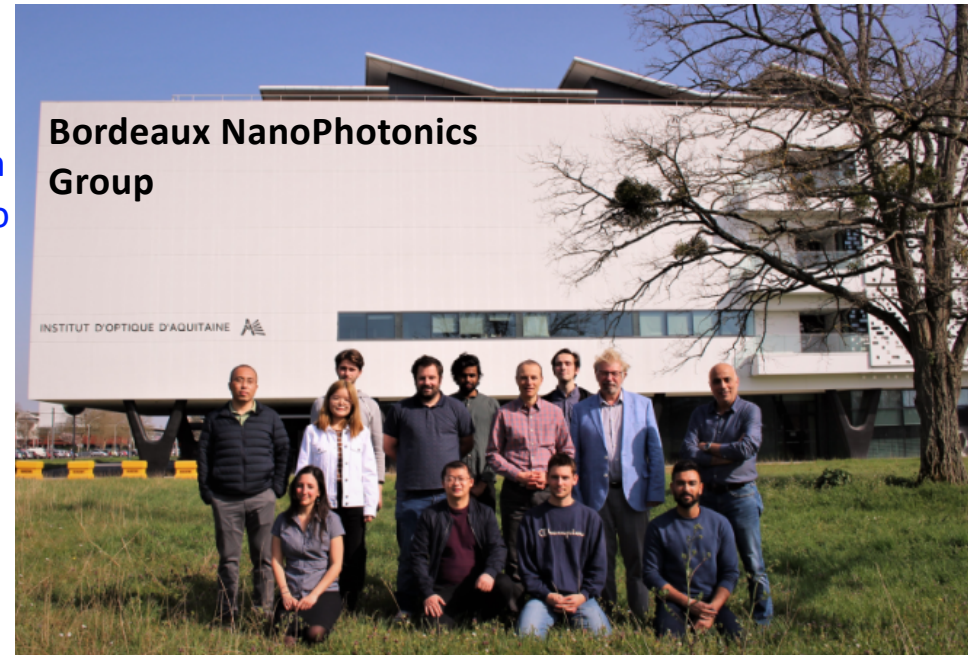

Thank you for your attention

